

A simulation of anomalies to aid the interpretation of magnetic data

N. P. Sheen & A. Aspinall

Department of Archaeological Sciences University of Bradford

9.1. Introduction

A program of research has been established in order to design an interpreter for archaeological magnetic survey data. This has led to the performance of some general modelling experiments, which are of practical use. The aim of this paper is to present initial results and to consider the design of an interpretive system. The introduction to this paper deals with the practical aspects of a magnetic survey, how it is carried out, the type of data that is produced, and the reasons why this method is useful in an archaeological context. The main section is then divided into five topics:

1. Theory. The theoretical calculation of magnetic anomalies.
2. Implementation. Using the theoretical calculations to produce model responses.
3. Testing. Comparison with observed data to show that the calculations are correct.
4. Survey. A simulated survey to show the effect that sampling at a finite interval has on interpretation.
5. System design. How an interpretative system for data that can be modelled theoretically may be designed to analyse real results.

9.1.1. Background

The most widely used ground-based survey instrument in British archaeology is the fluxgate gradiometer. An experienced user can cover up to a hectare each day, making this method much faster than any other geophysical technique. The high data capture rate means that large amounts of information are produced which rely on the experience of the observer for accurate interpretation, and it is difficult to be objective when interpreting large data sets.

The fluxgate gradiometer consists of two coils usually separated by 0.5 or 1 m. These coils are driven in and out of saturation by a high frequency alternating current. When out of saturation, external magnetic fields can cause a current to flow in the coils, the frequency of which is proportional to the exciting field (Clark 1990). The use of two coils in a gradiometer configuration means that local variations in magnetic intensity are measured, and natural effects due to the Earth's magnetic field are eliminated.

Under normal conditions, the Earth's magnetic field affects both sensors equally and the instrument will read zero. Variations in the soil magnetic susceptibility will affect the lower sensor to a greater extent than the upper, giving a positive or negative reading depending on whether the material reinforces or opposes the Earth's field.

Human habitation causes magnetically-enhanced material to be deposited in the soil, with the result that otherwise invisible features are revealed by a gradiometer survey.

Ditches and pits cut into the subsoil, and subsequently filled with topsoil produce a positive anomaly, as topsoil has a higher magnetic susceptibility than subsoil. Organic and burnt material have a relatively high susceptibility, so are revealed as positive anomalies. Stone structures such as road bases or walls (not made of fired brick) have weak negative susceptibilities. The reasons why topsoil is magnetically enhanced are not fully understood, and many papers have been published on the subject, for detailed discussions of magnetic variations in the soil see Le Borgne (1955), Tite & Mullins (1971) and Mullins (1977).

When a site is surveyed, it is usually divided into 20 or 30m square grids. Readings are then taken on these grids at 0.25, 0.5 or 1.0m intervals. The results from a survey map the magnetic variations in the soil. The data is generally presented as an X-Y, dot density plot, grey scale or contour diagram (Figs. 9.1a-b).

As stated earlier the interpretation of results is carried out visually, relying on the experience of the observer. This analysis usually reveals the extent of a site and the location of any buried features, but does not inform on their size, shape or depth of burial. However this information is contained within the data as the shape of the response varies with the geometry of the causative body, and the magnitude according to its susceptibility, although this is not strictly true, and inhomogeneous enhancements may affect the shape of the anomaly. The manual interpretation of Figs. 9.1a-b is shown on Fig. 9.1c.

A simulation of the responses obtained from different sources can provide a valuable interpretative aid, and future work will be aimed at applying pattern recognition type algorithms to magnetic data, with a view to obtaining a more detailed interpretation. The present paper however serves to illustrate some limitations imposed by a finite sampling interval.

9.1.2. Magnetic Theory

The theory presented here is very brief, and is intended for illustrative purposes, for a formal development see Linnington (1972).

From simple magnetic theory, we can derive the expected response ΔZ due to a dipole buried at a point (x',y',z') , and measured at point (x,y,z) to be:

$$\Delta Z = M \frac{(2z^2 - x^2 - y^2) \sin I - 3xz \cos I}{(x^2 + y^2 + z^2)^{5/2}} \quad [9.1]$$

Where M is the magnetisation of the dipole, and I the inclination of the Earth's magnetic field. The shorthand has been used that x means $(x-x')$ and similarly for y and z .

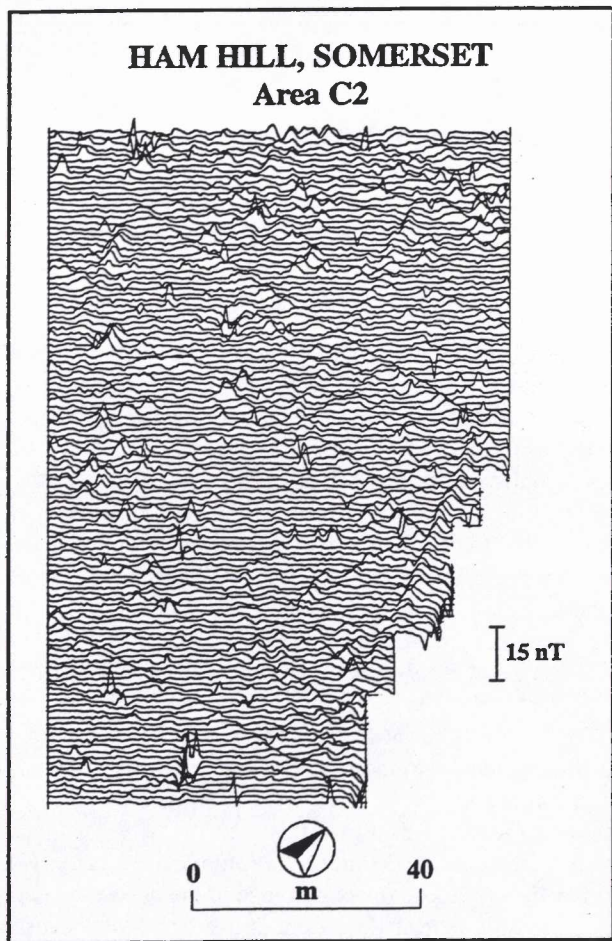

(a)

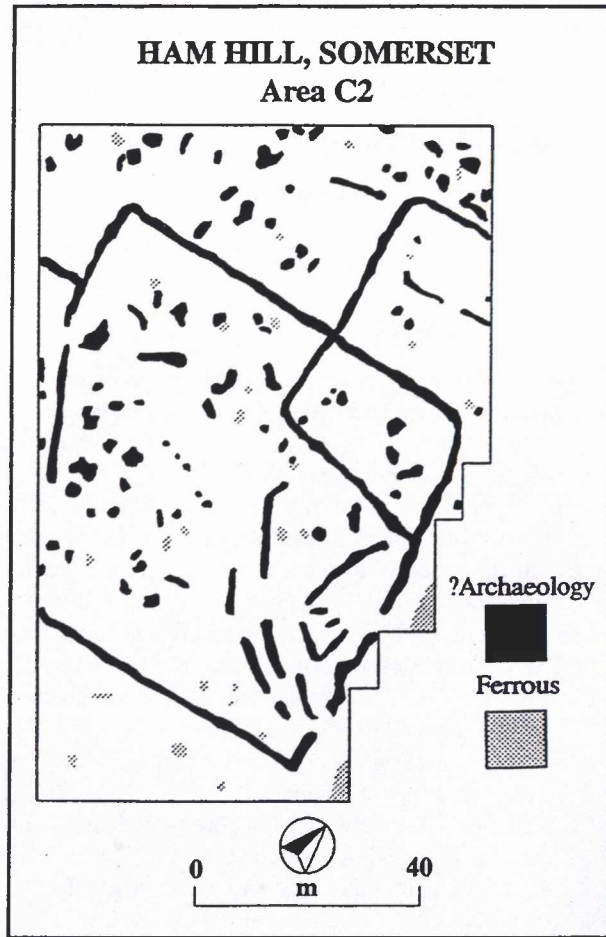

(c)

Figure 9.1: Ham Hill. (a) XY plot of survey; (b) dot density plot; (c) Interpretation of (a) and (b).

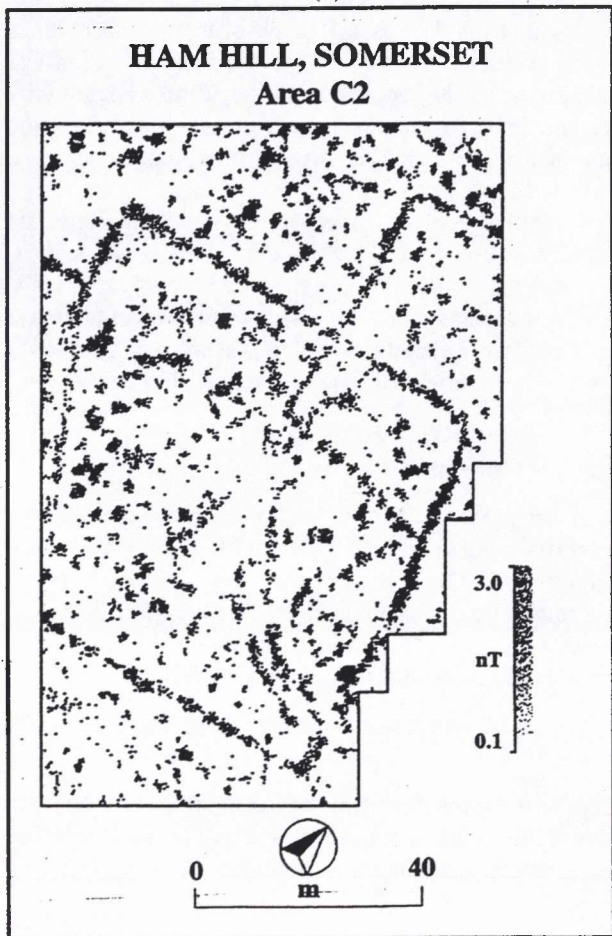

(b)

The anomaly due to an extended body can then be calculated by integrating over the volume of that body (Fig. 9.2). The anomaly is of the form:

$$\Delta Z = \iiint M \frac{(2z^2 - x^2 - y^2) \sin I - 3xz \cos I}{(x^2 + y^2 + z^2)^{5/2}} dV \quad [9.2]$$

This integral can only be evaluated analytically for the simplest of cases, and solutions generally require approximation methods. Various techniques have been published which address this problem: Talwani (1965), Bhattacharyya and Navolio (1977), Bhattacharyya and Chan (1977), Scollar (1968) and Scollar (1969). Most of these methods apply superposition in some way or another. In essence this principle states that the anomaly due to a complex shape can be calculated as the sum of simpler anomalies. This technique underlies the algorithms presented here, and is the key to building accurate descriptions of features with the minimum amount of computation. Equations 9.1 and 9.2 enable the calculation of the vertical component of the magnetic field at a point (x,y,z) . To calculate the field as measured by a fluxgate gradiometer, it is necessary to evaluate the appropriate equation twice for the points (x,y,z) , and $(x,y,z-h)$. Where h is the separation of the two fluxgates. The measured field is then simply the difference between the two calculations.

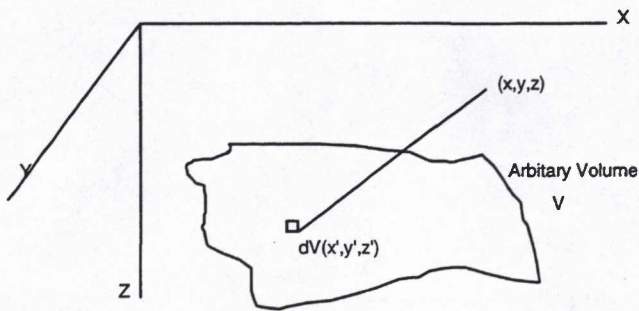

Figure 9.2: Calculation of the anomaly due to an arbitrarily shaped volume.

9.1.3. Implementation

Associated with this research are three basic generation programs, DIPOLE, LINE and PRISM. The source equations in these programs follow the derivations of Linnington(1972). The first calculates the field due a dipole at any depth, for a given inclination of the Earth's field. LINE calculates the anomaly due to a line source of any length or orientation. PRISM derives the response due to any prism shaped body from the depth of the top and bottom faces, and the (x,y) co-ordinates of the apexes. These units provide the primary building blocks for the modelling of more complex features.

Three other routines then allow these to be manipulated. These are SUMPOLE, SUPER and MERGE. SUMPOLE calculates the field from a superposition of dipoles by specifying their (x,y,z) co-ordinates. SUPER derives the resultant anomaly from a combination of fields, e.g. the anomaly at the crossing point of two ditches. MERGE allows the construction of large sites from files of anomalies.

The actual implementation of these programs will not be discussed, as it is fairly straight forward. However, initial results are presented and linked with practical considerations. The inputs and outputs of the above programs are summarised in Tables 9.1-2. A unit called SURVEY is also included in Table 9.2, as this was used for the second part of the results section.

To calculate the anomaly due to a complex body, it is possible to represent it as a superposition of prisms, line sources, or dipoles. Any level of accuracy can be achieved simply by representing the feature at a finer level. Sufficient accuracy (compared with the accuracy of a typical survey) can usually be obtained with a coarse representation in a few minutes.

9.2. Results

9.2.1. Testing the accuracy of the modelling

The first results presented relate to a survey at Haddon Farm, Cambridgeshire, carried out by Geophysical Surveys of Bradford in 1989. Excavations were carried out, by Dr. C. French, then of Fenland Archaeological Trust. Using soil samples, and cross-section diagrams for a large pit, that was revealed in both the excavations and the gradiometer survey, it is possible to model the expected anomaly due to this feature. The simulation should produce comparable results to the gradiometer survey; if the modelling is cor-

Unit	Input	Output
Dipole	Depth of burial, inclination of Earth's Magnetic Field (EMF)	anomaly due to dipole
Line	Depth of burial, orientation relative to magnetic north, length, inclination of EMF	anomaly due to line source
Prism	Depth of top and bottom faces, (x,y) co-ordinates of apexes	anomaly due to prism

Table 9.1: Generation programs.

Unit	Input	Output
Sumpole	(x,y,z) co-ordinates of dipoles, relative magnetisation	Resultant field due superposition of dipoles
Super	Any number of anomalies, relative magnetisation	Resultant field
Merge	Any anomaly files	Composite of anomalies
Survey	Any file, sampling interval in x,y directions	survey of site

Table 9.2: Manipulation programs.

rect. The model was constructed by representing each layer of the pit as a prism, and then superimposing the field from each layer with a weight according to it's magnetisation. The cross section diagram is shown in Fig. 9.3. The lower part of Fig. 9.3 shows how the cross section was modelled as a set of prisms, and the numbers correspond to the layers in Table 9.3. The susceptibilities in Table 9.3, are from measurements on soil samples taken from a section through the centre of the pit. Samples were not available for the surrounding topsoil or subsoil. This will not significantly affect the model as the susceptibility is primarily a scaling factor, and it is the shape of the feature that determines the shape of the anomaly. Figs. 9.4-5 show the calculated and observed anomalies respectively, for the pit. Comparing

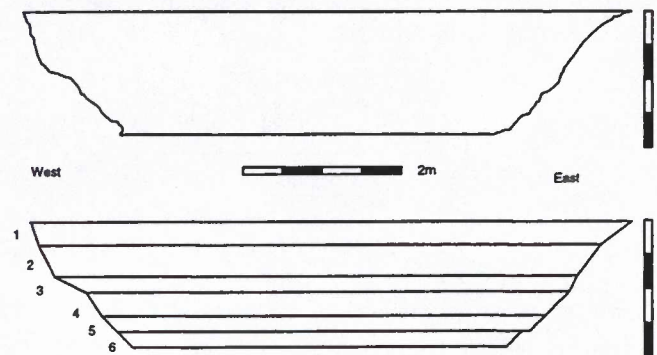

Figure 9.3: Representation of the section for Pit F39. (courtesy of Dr. C. French, Fenland Archaeological Trust.)

Layer	1	2	3	4	5
Susceptibility	91	202	87	61	39

Table 9.3: Magnetic susceptibility results. Layers as marked in Fig. 9.3. Susceptibility measured in 10⁻⁶ emu/g.

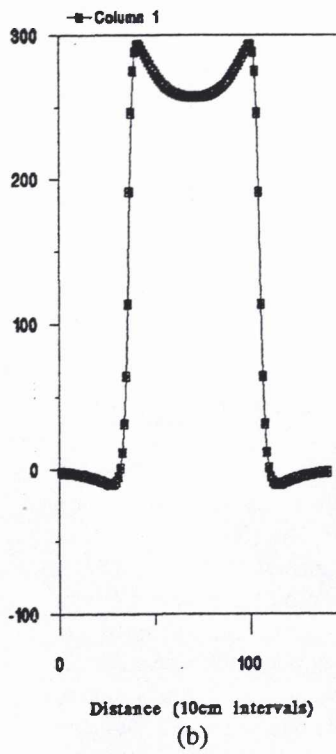
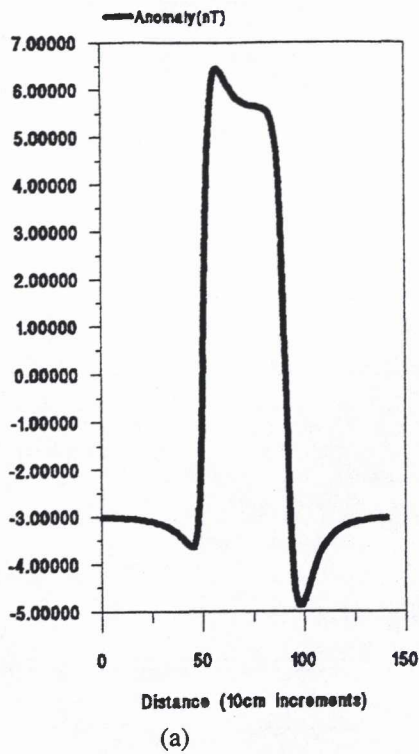

Figure 9.4: (a) Theoretical anomaly for F39. (b) First calculation of pit anomaly.

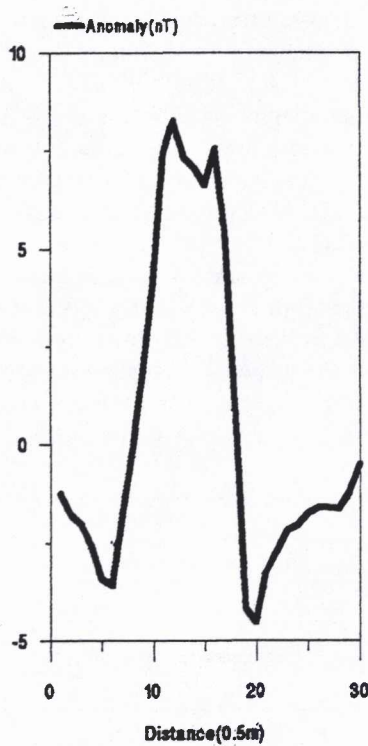

Figure 9.5: Observed pit anomaly.

Figs. 9.4 and 9.5, it is obvious that the shapes of the anomalies are similar, and the model produces comparable results. This comparison is not "scientific" as it is very difficult to assess all the inherent uncertainties. Cross sections were only available for the centre of the pit, and the peak of the anomaly occurs at the southern edge. When the feature was modelled without taking into account effects at the edge of the pit, and simply using the central cross section a very poor comparison with observed data was produced. The excavation plans appeared to indicate that the pit narrowed at its northern and southern edges. When a

thinning of the cross section at the extremities was introduced, a "better" model was obtained. This suggests that the shape of the peak anomaly may be largely determined by the shape of the southern edge of the feature, as it is at this point that the major contrast occurs. The differences in magnitude of the observed anomaly and the model are probably due to a reduction in the susceptibility of the fill at the edges of the pit, compared to the soil samples, which were taken from the centre. This suggests that most of the enhanced material was probably "thrown" into the middle of the pit, before it was later filled.

The shapes of the two anomalies are sufficiently similar to provide confidence in this method of modelling magnetic anomalies, and discrepancies are due to the causes outlined above.

Having shown that modelling produces the expected results, practical predictions can be made. A simulated survey of a hypothetical site is presented. This serves to demonstrate that sampling at a finite interval may lead to misinterpretation.

9.2.2. Simulated survey

The site, called SIM SITE, consists of two ditches and two pits. One ditch in the N-S direction, and one in the E-W direction (Figs. 9.6-7). All features in the site were calculated with a contrasting susceptibility of 10 SI units. That is to say if the topsoil susceptibility was 5 SI, the fills of the features would be 15 SI units.

Figs. 9.6-7 show an exact representation of the anomalies on the site. Survey results are a sample of this continuous field. It is essential to determine how representative survey data is for different sampling intervals. Figs. 9.8-9 show the site surveyed at 0.5m intervals and Figs. 9.10-11

Fig. 9.6: Wire frame plot of SIM SITE.

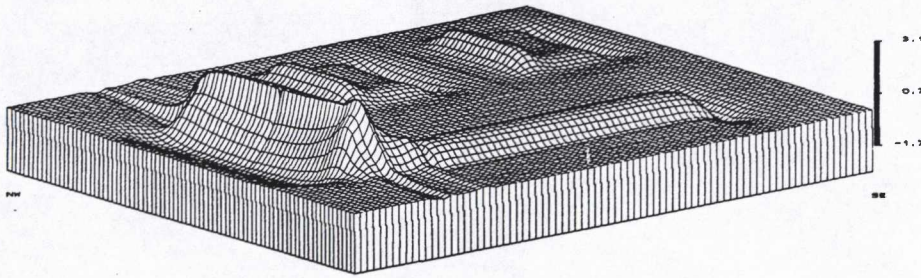

Figure 9.7: Contour plot of SIM SITE.

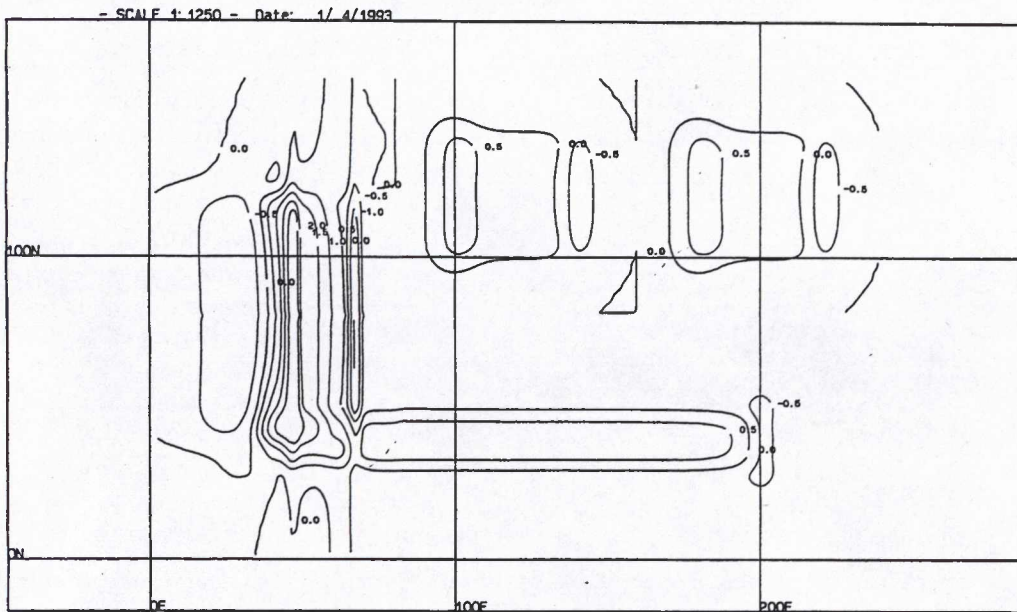
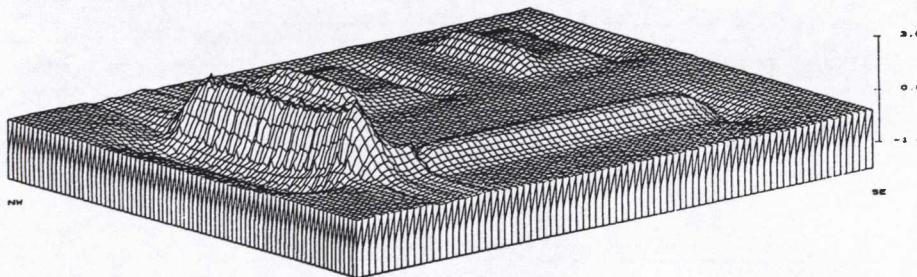

Figure 9.8: Survey of SIM SITE at 0.5m intervals — wire frame plot.



at 1m intervals. The presence and location of features are obvious, but fine detail and edge effects are lost completely. The pits could easily be misinterpreted as most of the anomaly is below typical noise level. This statement does however depend on the local soil conditions, and the susceptibility of the pit. In practice a survey would show a small positive anomaly to the south of the pit, and a small negative one to the north, which bear little resemblance to the true extent of the feature.

In the above survey the effects of noise have been ignored, and some readings may be below the sensitivity of the instrument. It is however possible to incorporate these effects, but their magnitudes depend greatly on local conditions. Simulations of this type illustrate practical problems, but also provide important theoretical parameters. To ap-

ply pattern recognition to a discrete data set, however this recognition is carried out, there is an inherent limit on the resolution of this process imposed by the sampling interval. Therefore when designing a recognition system, it is essential to realise this limit. As a prequel to future work the design of a pattern recognition layer for magnetic data, and an interpretive system is considered.

9.2.3. Further work system design

The input to the system will be a grid or series of grids from a survey, and the orientation of the grids relative to magnetic north. The desired output is a description of any anomalies contained within the grids. The design presented here is an overall system design and does not consider the

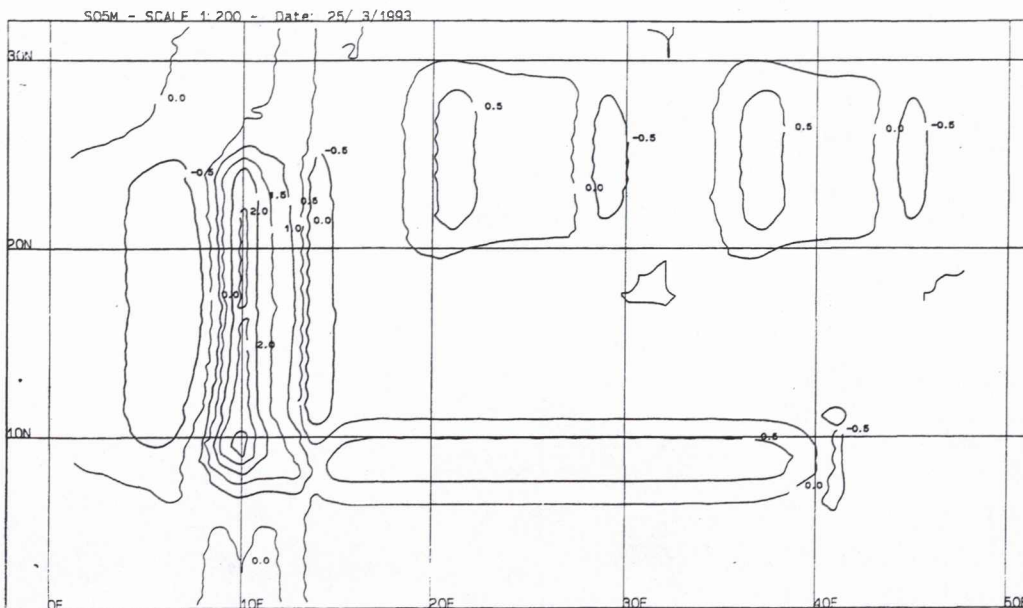

Figure 9.9: Survey of SIM SITE at 0.5m intervals — contour plot.

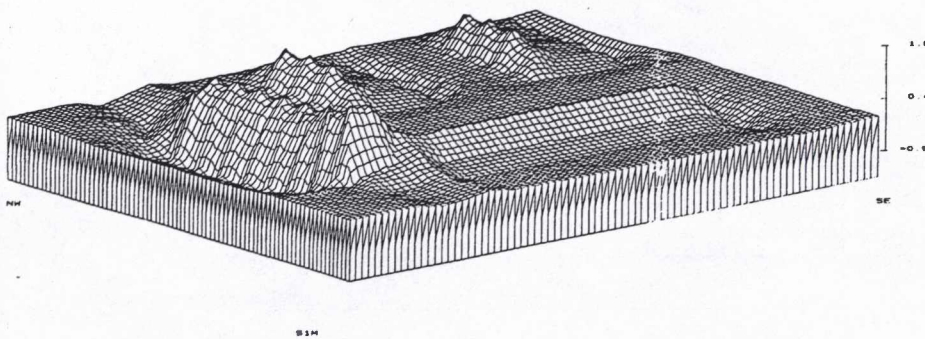

Figure 9.10: Survey of SIM SITE at 1.0m intervals — wire frame plot. The multiple peaks on the E-W ditch is an artefact created by the display package.

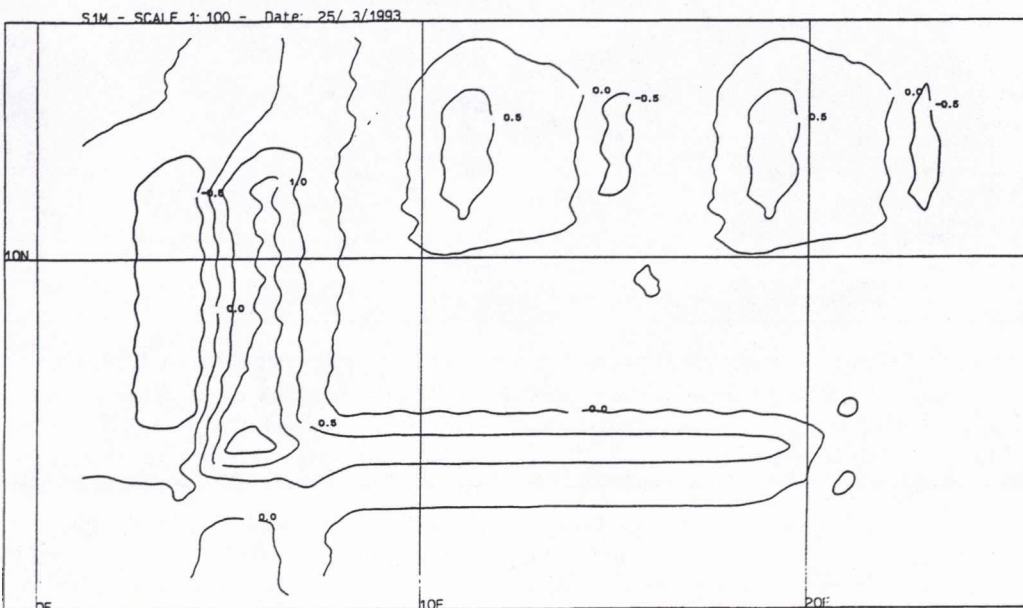

Figure 9.11: Survey of SIM SITE at 1.0m intervals — contour plot.

implementation of each level in detail, but serves to break the problem into smaller more easily tackled units. An overview of the system is shown in Fig. 9.12.

The first recognition that can be carried out by the application of a simple filter is the location of iron spikes.

These do not require detailed recognition, and it is sufficient to locate and remove them using a mean filter. It is important to note that the whole data set is not filtered, the mean filter acts as location device, and only affects spike-like anomalies in the data set. The next pre-processing

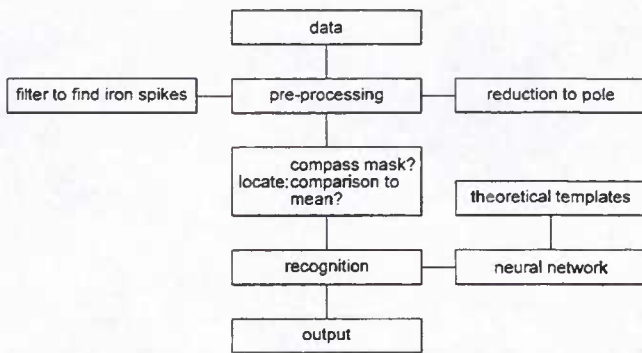

Figure 9.12: An interpretive system for magnetic data.

operation is a reduction to the pole, this serves to make the system universal as anomaly shapes no longer depend on the orientation of features or the inclination of the Earth's field.

Anomalies must then be located within the grid, and stored in a suitable form for processing in the pattern recognition layer. Some work has already been carried out on the design of this layer, and it was decided that a neural approach will be the most effective way of recognising anomalies. An algorithm based comparison, which performed some sort of statistical correlation would be unreliable for gradiometer data. The data is not comparable to an image, and there are generally only five or six readings across a feature. The network would be trained on the various template curves created using the modelling procedures shown previously. The input data would then be normalised to remove any scaling of the pattern due to local soil properties. This approach has the benefits that anomalies do not need to be located exactly, as the neural network will still recognise the input pattern even if it is not exactly coincident with the relative training pattern. The application of neural networks to gradiometer data is currently under research. The final output will then be a list of anomalies with their locations and descriptions, and possibly a map of the sub surface.

9.3. Conclusions

The applications of these experiments are of great importance for archaeological geophysics, as it is possible to investigate the fields due to crossing features and edge effects. It is possible to simulate features that produce confusing anomalies, for example wide ditches may appear as two features since only the edges are revealed. The main motivation for simulated surveys is to investigate the effect on anomaly shape, due to the finite sampling interval. This loss of information will limit the resolution of any pattern matching that is applied to the data; the recognition layer should be designed with this limit in mind. The results of these experiments may also have repercussions on field sampling intervals.

The system design has wider applications than purely magnetic data. The system could be trained to interpret any data where templates or theoretical calculations are available. Pre-processing operations would be dependent on the actual data type, but the body of the system could be generalised.

Acknowledgements

The authors would like to thank Dr. Carl Heron of Bradford University Archaeological Sciences Department for reading earlier drafts of this paper, and his general support. Thanks are also due to Dr. Chris Gaffney and John Gater of Geophysical Surveys of Bradford for setting up this project, providing data, hard copy output and useful advice.

Bibliography

- BHATTACHARYYA, B. & K. Chan 1977. "Computation of gravity and magnetic anomalies due to an inhomogeneous distribution of magnetisation and density in a localised region", *Geophysics* 42: 602-9.
- BHATTACHARYYA, B. & M. NAVOLIO 1977. "Digital Convolution for computing gravity and magnetic anomalies due to arbitrarily shaped bodies", *Geophysics* 42: 981-992.
- CLARK, A. 1990. *Seeing Beneath the Soil*. Batsford, London.
- GAFFNEY, C. & J. GATER 1992. *The use of geophysical techniques in archaeological evaluation*. Institute of Field Archaeologists Technical Paper no. 9.
- LE BORGNE, E. 1955. "Susceptibilitie magnetique anormale du sol superficiel", *Annales geophysique* 11: 399-419.
- LINNINGTON, R. E. 1972. "A simple theory applicable to magnetic prospecting in archaeology", *Prospezioni Archaeologiche* 7: 9-60.
- MULLINS, C. 1977. "Susceptibility of the soil and it's significance", *Journal of Soil Science* 28: 233-246.
- SCOLLAR, I. 1968. "A program package for the interpretation of magnetometer data", *Prospezioni Archaeologiche* 3: 9-18.
- SCOLLAR, I. 1969. "A program for the simulation of magnetic anomalies of archaeological origin in a computer", *Prospezioni Archaeologiche* 4: 59-83.
- TALWANI, M. 1965. "Computation with the help of a digital computer of magnetic anomalies caused by bodies of arbitrary shape", *Geophysics* 30: 797-817.
- TITE, M. S. & C. MULLINS 1971. "Enhancement of the magnetic susceptibility of soils on archaeological sites", *Archaeometry* 13: 209-220.
- N. P. Sheen
 Department of Archaeological Science
 University of Bradford
 Bradford
 West Yorkshire
 BD7 1DP
 TEL: (0274) 733466 ext 3556
 E-MAIL : N.SHEEN@uk.ac.bradford