

A New Synthetic Pathway to 8-Hydroxy-2,4,6-trimethyl-4-Nonenoic Acid as Precursor for the Total Synthesis of Jasplakinolide

Ein neuer Syntheseweg zu 8-Hydroxy-2,4,6-trimethyl-4-Nonensäure als Vorstufe in der Totalsynthese von Jasplakinolid

DISSERTATION

**der Fakultät für Chemie und Pharmazie
der Eberhard-Karls-Universität Tübingen**

**zur Erlangung des Grades eines Doktors
der Naturwissenschaften**

2005

vorgelegt von

Saengchai Wattanasereekul

Tag der mündlichen Prüfung:

05. Oktober 2005

Dekan:

Prof. Dr. S. Laufer

1. Berichterstatter:

Prof. Dr. M. E. Maier

2. Berichterstatter:

Prof. Dr. Th. Ziegler

This doctoral thesis was carried out from June 2001 till July 2004 at the Institut für Organische Chemie, Fakultät für Chemie und Pharmazie, Eberhard-Karls-Universität Tübingen, Germany, under guidance of Professor Dr. Martin E. Maier.

The author wishes to express deep and sincere gratitude to advisor Prof. Dr. Martin E. Maier for providing the opportunity to study in the perfect working conditions, with competent and helpful research associates in his laboratories. Appreciation is also expressed for his teaching every little detail about synthetic organic chemistry techniques, his very kind assistance, generous advice and guidance, constant encouragement and limitless patience throughout the course of the highly interesting research project of my doctoral thesis.

Prof. Dr. Thomas Ziegler, I would like to thank for his helpful reviewing the doctoral thesis and for giving valuable comments and suggestions for its improvement.

Thanks are also extended to all previous and present members of the working group of Prof. Dr. Martin E. Maier for their valuable discussions, suggestions and guidance in all chemistry questions and excellent collaboration. Special appreciation goes to Dr. Pradip Sasmal, Dr. Christoph Herrmann, Dr. Tzvetelina Marquardt, Dr. Alexander Bayer, Dr. Andreas Petri, and Evgeny Prusov for many valuable suggestions, technical support and help to approach various questions in chemistry and to shape my techniques in the laboratory.

Further thanks go to Mr. G. Nicholson for his skilful technical assistance in various measurements, Mrs. I. Werner and Mrs. Munari for preparing the absolute solvents and managing the chemicals in the laboratory.

Special thanks are given to the Hätschers and all friends in Tübingen for their tremendous amount of support during the author is studying and living in Tübingen, Germany.

Finally, the deepest affectionate gratitude is acknowledged to my parents and family members for their permanent love, understanding and encouragement throughout my entire life and thorough course of study till able to achieve this goal.

My family

for all of the love

Publication:

M. E. Maier, S. Wattanasereekul, Synthesis of the 8-Hydroxy Acid of Jasplakinolide. *Adv. Synth. Catal.*, **2004**, 346, 855-861.

CONTENTS

1 INTRODUCTION	1
2 LITERATURE REVIEW	4
2.1 Historical Account of Jasplakinolide.....	4
2.2 The Family of Jasplakinolide	5
2.3 Synthesis of Jasplakinolide.....	8
2.3.1 β -Tyrosine Derivative.....	9
2.3.2 2-Bromoabrine Derivative.....	10
2.3.3 Tripeptide Fragment	11
2.3.4 Macrolactonization of Jasplakinolide.....	13
2.4 Synthesis of 8-Hydroxy-2,4,6-trimethyl-4-nonenoic acid.....	14
2.4.1 The Grieco Group' s Strategy.....	15
2.4.2 The Schmidt Group's Strategy	16
2.4.3 The White Group's Strategy.....	17
2.4.4 The Momose Group's Strategy	18
2.4.5 The Konopelski Group's Strategy	19
2.4.6 The Kang Group's Strategy.....	19
2.4.7 The Rama Rao Group's Strategy.....	20
2.4.8 The Shioiri and Hamada Group's Strategy	22
2.5 Critical Review and Reason for Undertaking This Study	23
2.6 Goal of Research	23
3 RESULTS AND DISCUSSION.....	25
3.1 Retrosynthetic Analysis.....	25
3.2 Synthetic Pathway to the 8-Hydroxy Acid of Jasplakinolide.....	26
3.2.1 Bakers' Yeast Enantioselective Reduction.....	27
3.2.2 Cross Metathesis (CM).....	31
3.2.4 Stereoselective Enolate Alkylation.....	34
3.3 Alternative Approach to 8-Hydroxy Acid and Derivatives.....	48
3.3.1 Asymmetric Hydrogenation of β -Keto esters.....	51
3.3.2 Hydrolytic Kinetic Resolution.....	60
3.3.3 Asymmetric Alkylation catalyzed by Bis(sulfonamide) Ligands	70
3.3.4 Asymmetric Alkylation catalyzed by TADDOLates.....	72
4 CONCLUSION	80
5 EXPERIMENTAL PART.....	82
5.1 General Remarks	82
5.1.1 Chemicals and Working Technique	82
5.1.2 NMR-Spectroscopy	82
5.1.3 Mass Spectrometry	83
5.1.4 Infrared Spectroscopy.....	83
5.1.5 Polarimetry	83

Contents

5.1.6 Melting Points	83
5.1.7 Chromatographic Methods	84
5.2 Synthesis of the 8-Hydroxy Acid of Jasplakinolide	84
5.3 Alternative Approach to 8-Hydroxy Acid and Derivatives	97
6 REFERENCES.....	116
7 APPENDIX.....	128

ABBREVIATIONS

%	percent
α	specific rotation
δ	chemical shift in ppm (NMR)
$\tilde{\nu}$	wavelength (IR)
°C	degree Celsius
abs.	absoluted
Ac	acetyl
b.p.	boiling point
Bn	benzyl
Boc	<i>tert</i> -Butoxycarbonyl
Bu	butyl
BuLi	butyllithium
<i>c</i>	concentration
COSY	corelated spectroscopy
CM	cross-metathesis
Cy	cyclohexyl
de	diastereomeric excess
DIBAL-H	diisobutylaluminium hydride
DMAP	dimethylaminopyridine
DME	1,2-dimethoxyethane
DMF	dimethylformamide
DMSO	dimethylsulfoxide
ee	enantiomeric excess
EI	electron impact
eq.	equivalent(s)
ESI	electrospray ionization
Et	Ethyl
FAB	fast-atom bombardment
FD	field-desorption
FT-IR	fourier transform infrared spectroscopy
g	gram(s)

ABBREVIATIONS

GC	gas chromatography
h	hour(s)
HMPA	hexamethylphosphorous triamide
HPLC	high performance liquid chromatography
HRMS	high resolution mass spectrometry
Hz	hertz
imid.	Imidazole
<i>i</i> -Pr	isopropyl
IR	infrared
<i>j</i>	coupling constant
L	liter(s)
LAH	Lithium aluminum hydride
LDA	lithium diisopropylamide
LHMDS	Lithium hexamethyldisilazide
Ref.	reference(s)
<i>M</i>	moles per liter
m.p.	melting point
m/z	mass to charge ratio
Me	methyl
Mes	mesityl, 2,4,6-trimethylphenyl
mg	milligram
MHz	megahertz
min	minute(s)
mL	milliliter(s)
mol	mole(s)
MOM	methoxymethyl
Ms	methanesulfonyl (mesyl)
MS	mass spectrometry
<i>N</i>	gram equivalent weights per liter
NMR	nuclear magnetic resonance
Np	β -naphthyl
PCC	pyridinium chlorochromate
PG	protecting group
Ph	phenyl

ABBREVIATIONS

Pr	propyl
Py	pyridine
BINAP	2,2'-bis(diphenylphosphino)-1,1'-binaphthalene
BINOL	1,1'-binaphthol
R _f	retention factor
SAR	Structure Activity Relationships
TBAF	tetra- <i>n</i> -butylammonium fluoride
TBDPS	<i>tert</i> -butyldiphenylsilyl
TBS	<i>tert</i> -butyldimethylsilyl
<i>t</i> -Bu	<i>tert</i> -butyl
Tf	trifluoromethanesulfonyl (triflyl)
THF	tetrahydrofuran
TLC	Thin layer chromatography
TMEDA	<i>N,N,N',N'</i> -tetramethyl-1,2-ethylenediamine
TMS	Trimethylsilyl
Ts	tosyl, <i>p</i> -toluenesulfonyl
TS	transition state
μ ,	micro
UV	ultraviolet
VE	valence electron

ABBREVIATIONS

1 INTRODUCTION

Natural Products (naturally occurring organic chemical compounds) from worldwide sources such as plants, animals, marine organisms or microorganisms, have always fascinated chemists. Interesting and intriguing chemistry is involved in their *in vivo* production and in their laboratory utilization. Their role as biologically active molecules, (substrates for life processes, toxins, hormones, drugs, *etc.*) and as novel structural materials, is of unparalleled importance. Knowledge of their biological properties is important, not only for the discovery of new therapeutic agents, but also for the extension of basic knowledge for further drug development. In addition, chemical substances from natural sources can be easily degraded by biological pathways where no toxic waste remains that otherwise might cause pollution.

The search for marine natural products, the secondary or non-primary metabolites produced by organisms that live in the sea, is a relatively new area of research. Marine, as well as terrestrial organisms, produce this class of chemicals to provide the organism with an advantage over its neighbors. Marine invertebrates such as sponges, corals and tunicates are among the well-researched organisms primarily because of their size and abundance. Another interesting fact is that the majority of bioactive marine natural products have been isolated from soft-bodied, sessile or slow-moving marine invertebrates.¹ They are devoid of morphological defense structures, such as spines or protective shells, which demonstrates the ecological importance of these metabolites for responding to environmental stress. Here natural products are used to fight off potential predators, or to force back competing neighbors.² This form of chemical warfare has resulted in some of nature's most toxic chemicals.

To date most of the pharmaceuticals that are derived from natural products have been obtained from terrestrial organisms. However, the marine environment was largely untapped and unknown as far as chemistry goes, and in recent years led to a vast array of novel organic molecules. Many of these molecules possess unique structural features that are enormous and specific enough to protect the organisms in a very hostile environment. New drug discoveries indicate that marine organisms have a tremendous potential for new pharmaceuticals and will become a much more prolific source than any other group of terrestrial organisms. Among the marine toxins that shows promising biological activities, the cyclodepsipeptide jasplakinolide (**1**) is a notable example.

Jasplakinolide was isolated from the marine sponge *Jaspis sp.*³ This compound shows potent antifungal, insecticidal and antitumor activity. These activities are due to the interaction with actin filaments. Therefore, jasplakinolide is also an important biochemical tool. It represents a new class of bioactive cyclodepsipeptides. The structure incorporates both peptide and polypropionate units. It is part of a growing family of structurally related marine-derived natural products; geodiamolides A-F, TA, and neosiphoniamolide (see next chapter). Their structures differ in the composition of the tripeptide, but share the same 11-carbon polypropionate unit.

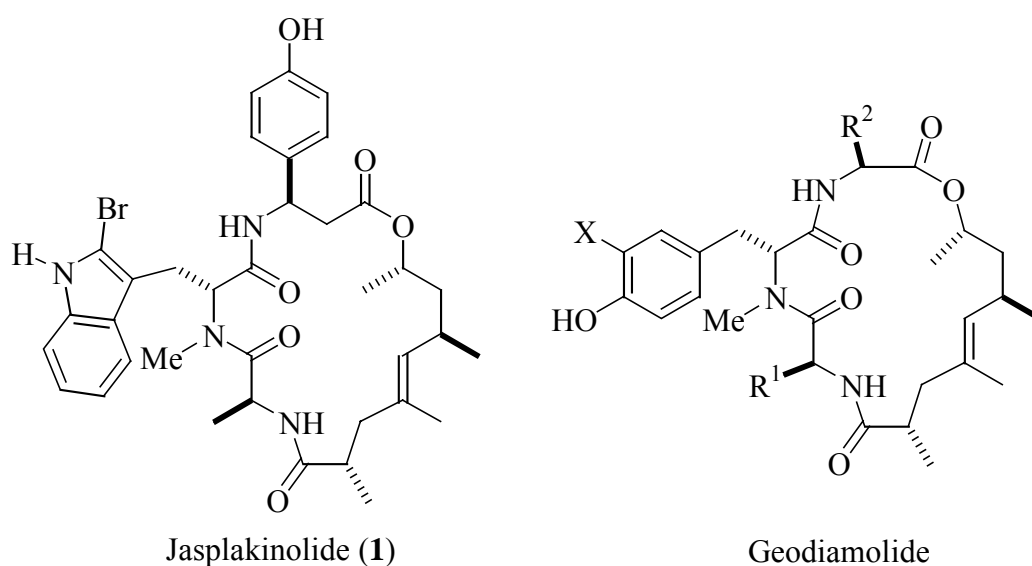
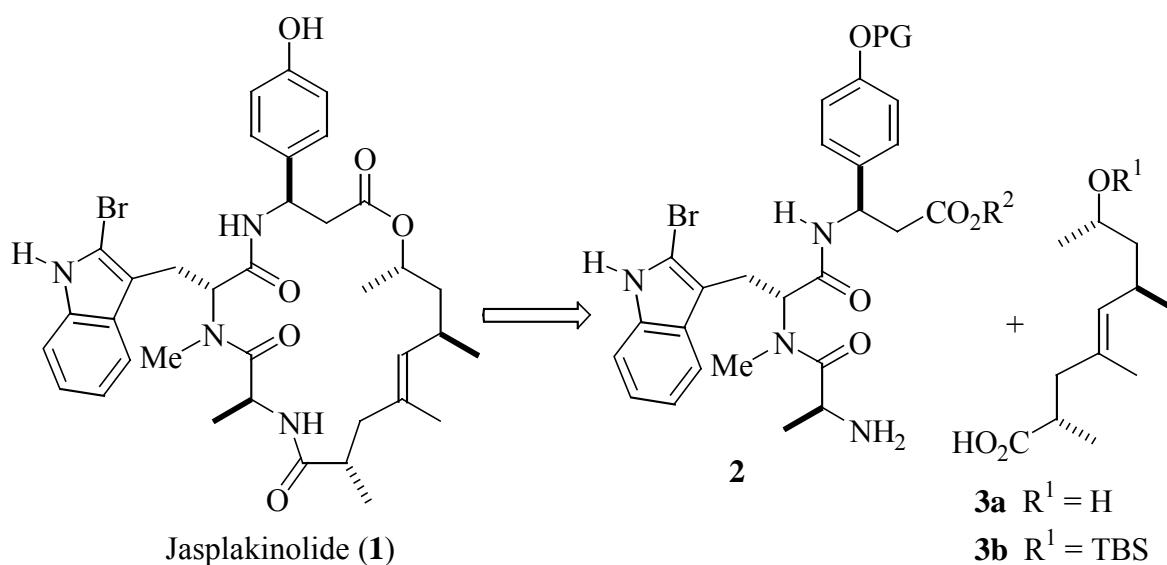

Figure 1: Structure of jasplakinolide (1) and geodiamolide.

Jasplakinolide and other related cyclodepsipeptides possess very high activity against a number of tumor-derived cell lines, and therefore appear to be very promising candidates for cancer chemotherapy. This has made them very attractive for further biological investigation and structure-activity relationship (SAR) studies. However, their low natural abundance reflects the scarcity of these compounds. For example, only 1 mg of jasplakinolide can be obtained from 3.3 kg of fresh marine sponge *Jaspis sp.*^{3b} The current price for this compound in research chemical amounts is about \$4000 per mg.⁴ Accordingly, total syntheses of jasplakinolide, as well as others in this family, has become an attractive and challenging option.



Scheme 1: The retrosynthetic pathway to jasplakinolide (**1**).

Here, in this work a total synthesis of jasplakinolide and tripeptide part is not proposed. Instead, our target was an efficient synthesis of the polypropionate unit. The work to be presented in this project describes a new synthesis of the 8-hydroxy-nonenic acid (**3b**) from commercially available starting materials. It further includes an extensive review for the preparation of this compound. As noted earlier, jasplakinolide is being used as an important biochemical tool in cytoskeletal research. In addition, the synthesis of analogs with different substituents at *C2* and/or *C8* using similar key steps was investigated.

2 LITERATURE REVIEW

2.1 Historical Account of Jasplakinolide

Jasplakinolide (jaspamide),³ was first time reported in 1986 as a novel biological active cyclodepsipeptide. It was isolated from the Indo-Pacific marine sponge *Jaspis johnstoni* (order Astrophorida; family Jaspidae).⁵ It is now known as *Jaspis sp.* or *Jaspis splendens*.⁶ The cyclic depsipeptide was initially described as an antimicrobial, insecticidal, and antifungal agent.^{3,7}

CLASSIFICATION⁸



Kingdom	Animalia
Phylum	Gelatinosa
Class	Demospongia
Subclass	Tetractinomorpha
Order	Choristida
Family	Jaspidae
Genus	<i>Jaspis</i>
Species	<i>Jaspis splendens</i>

Figure 2.1: *Jaspis splendens*.

Additional investigations revealed that jasplakinolide possessed potent antihelminthic properties⁹ and caused dramatic changes in the cytoskeleton of plant cells.¹⁰ This compound also displayed potent antiproliferative properties in the NCI-60 cell line screen.^{7b,11} Jasplakinolide is also active against tumor-derived cell lines, human prostate carcinoma and myeloid leukemia.¹² Furthermore, the drug is also active *in vivo* against Lewis lung carcinoma and human prostate carcinoma xenografts.¹³ Exposure of cells *in vitro* to jasplakinolide results in the formation of multinucleated cells. This prompted further investigation of its biological properties.^{11b,14}

In the meantime, it was found that this compound has another use. It proved to be an invaluable tool to probe cytoskeletal proteins and to observe the role of actin microfilaments.¹⁵ The study explored a variety of cellular processes. Among these are: cell movement, integrin-mediated adhesion, oocyte maturation, transport in the endocytic pathways and protein trafficking in the Golgi apparatus.

In a study of the mechanism of action it could be shown that jasplakinolide exerts its cytotoxic effect by sneaking into the cells. Then, it disrupts the actin cytoskeleton, inducing actin polymerization. It also inhibits the depolymerization of actin filaments. Other studies demonstrated that this cell-permeable drug not only potently induces actin polymerization, but also competitively inhibits the binding of phalloidin to F-actin, thus stabilizing filaments effectively.¹⁶

2.2 The Family of Jasplakinolide

Jasplakinolide presents as a new class of bioactive cyclodepsipeptides from marine sponge. The derived structure as a 19-membered macrocyclic ring incorporates both peptide and polypropionate portions. Besides the presence of the polyketide moiety, this depsipeptide also bears two rare amino acids, β -tyrosine and 2-bromoabrine. The key structural feature of cyclic depsipeptides is the replacement of an amide bond with an ester bond. The most common modification includes *N*-methylation or extension of the carbon chain. Aromatic amino acids such as tyrosine or tryptophan sometime contain ring substituents like halides. While β -hydroxy acids can be traced back to the corresponding α -amino acids, ω -hydroxy acids present in cyclic depsipeptides are made by the polyketide machinery.

Geodiamolides A-F, which also includes geodiamolide TA and neosiphoniamolide, are in the same family of jasplakinolide.¹⁷ These macrocyclic lactones share the same 11-carbon polypropionate unit i.e., the 8-hydroxy-2,4,6-trimethyl-4-nonenoic acid (**3a**). They differ structurally in the composition of the tripeptide portion. This is where the second amino acid unit occurs as a variable monohalogenated *N*-methyl-L-tyrosine. The third amino acid unit occurs as either L-alanine (geodiamolide A-C) or glycine (geodiamolide D-E) (Figure 2.2). These related marine cyclodepsipeptide compounds show weaker biological activity than jasplakinolide. For example, geodiamolide A and B are reported to have weaker antifungal activity than jasplakinolide.¹⁸

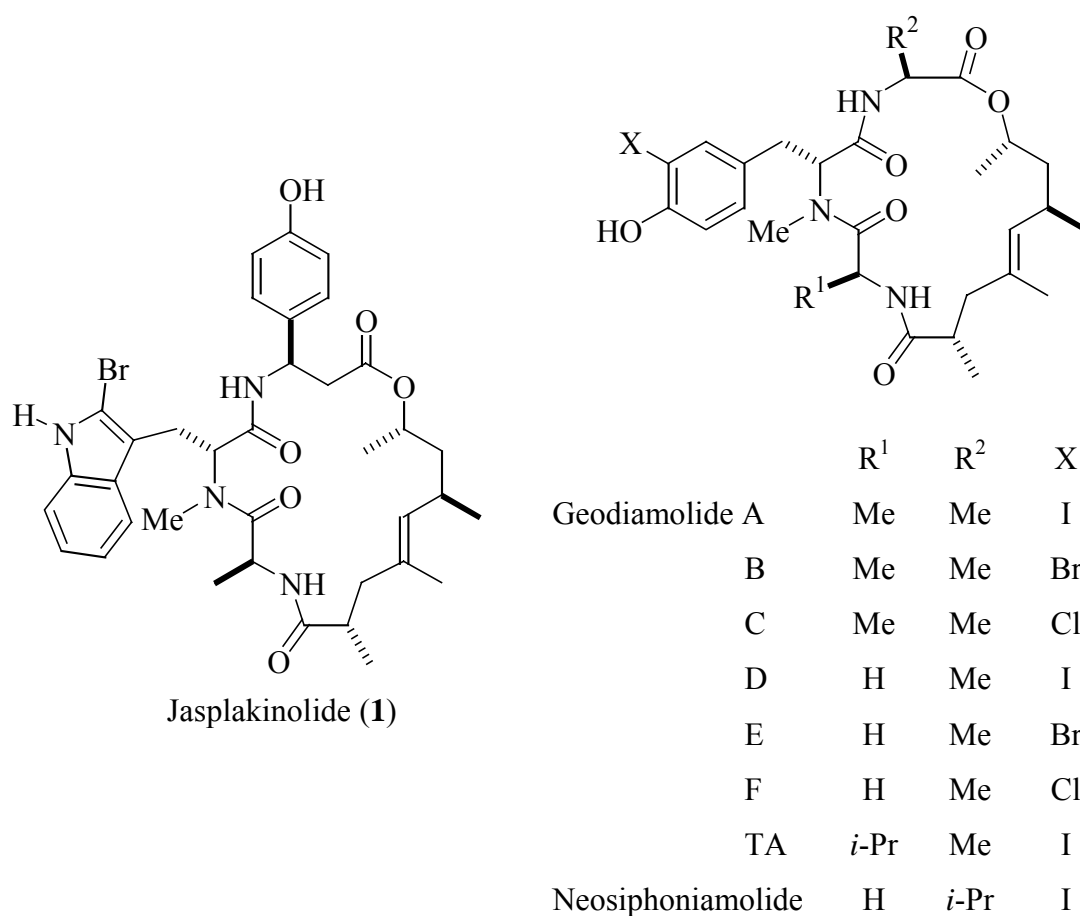

Figure 2.2: Structure of Jasplakinolide (1), Geodiamolides A-F, TA and Neosiphoniamolide.

Due to the presence of the β -amino acid in jasplakinolide they also have different ring sizes (19 vs. 18). It is not clear what the role of the individual building blocks is. The tripeptide fragment might mimic a peptide or protein ligand. The 8-hydroxy acid could function as a conformational control element involved in binding or not. Thus, akin to the immunosuppressives FK506 and rapamycin,¹⁹ jasplakinolide could be a dual domain molecule.

Irrespective of that, the ω -hydroxy acid is of interest from the viewpoint of conformational control. The hydroxy acid **3a** contains four methyl groups in a 1,3-distance. One can identify two syn-pentane interactions and one 1,3-allylic interaction. The consequence of the methyl groups is that the functional groups (carboxyl and hydroxy) at both ends of the chain point in one direction and allow bridging with a peptide fragment.

Based on the work of Hoffmann *et al.*,²⁰ one can assume that the conformation of the chain is largely determined by the central double bond and the three other methyl groups. While definitely several low energy conformations are possible, an arrangement such as the one depicted in Figure 2.3 should be accessible. This would still allow for an easy bridging.²¹ The conformation of the central part is governed by 1,3-allylic strain. The dihedral angles of the single bonds next to the allylic system are gauche⁺ (60°) and gauche⁻ (300°), respectively. Since the hydroxy acid **3** is of great interest as a controlling element for the orientation of bridging peptide fragments, we developed a novel synthesis for this compound.

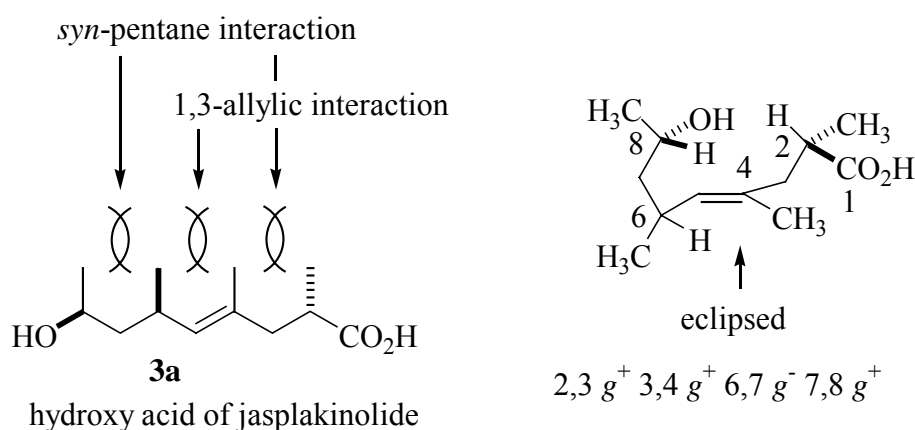
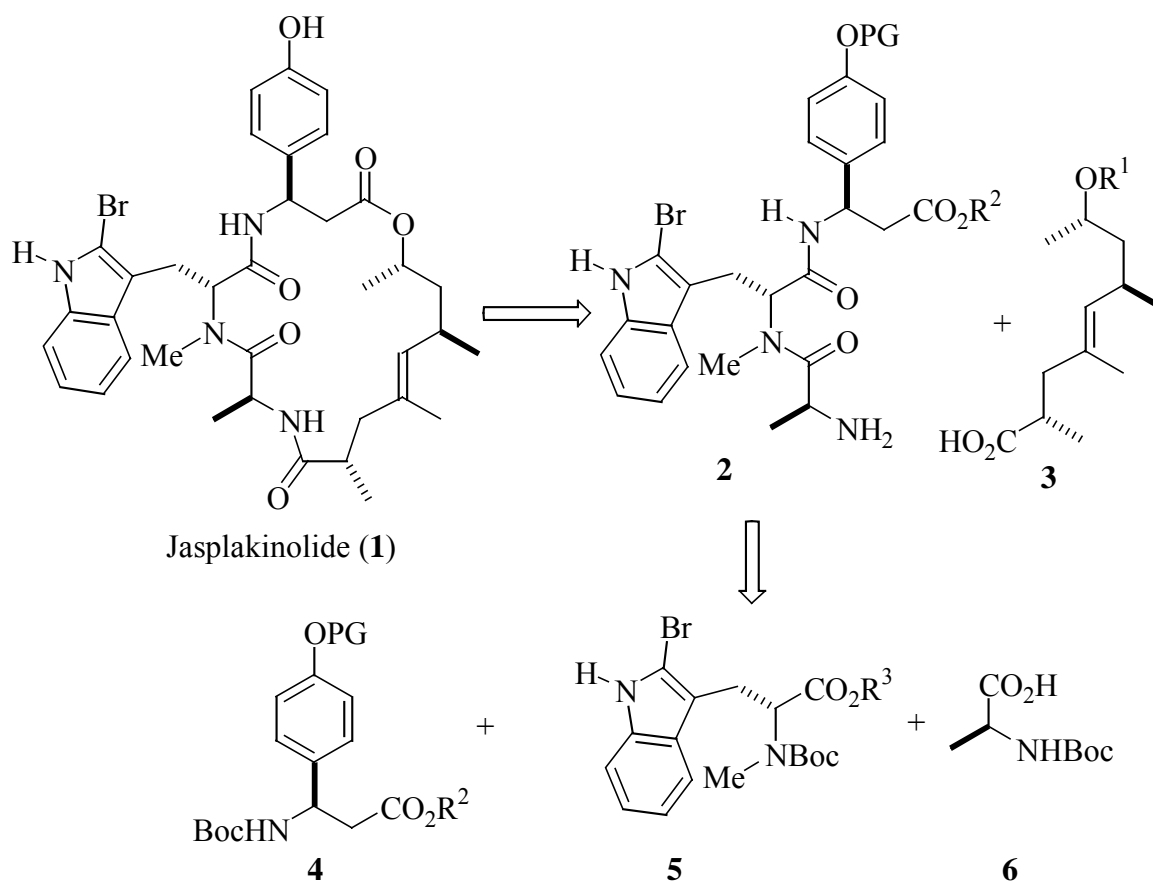

Figure 2.3: Possible conformation of the 8-hydroxy acid **3a** due to the avoidance of CH₃ - CH₃ steric interactions.

Soon after the recognition of the importance of jasplakinolide and geodiamolides, many working groups around the world began to pursue synthesis strategies of polyketide fragment **3a** as the most important prerequisite. Two years after jasplakinolide was first published, two groups announced the synthesis of **3a**-like molecule. One of them has finished the first total synthesis of jasplakinolide.²² To date, a fair amount of research has already been carried out on the synthesis of the polyketide fragment. Other research also exists in new total synthetic strategies forwards jasplakinolide and geodiamolides.

2.3 Synthesis of Jasplakinolide

From a retrosynthetic standpoint, jasplakinolide can be viewed as consisting of four distinct chiral subunits serially; protected hydroxy acid **3** and the protected constituent amino acid fragments **4-6**.



Scheme 2.1: Retrosynthetic pathway to jasplakinolide and tripeptide fragment.

Whereas protected (*S*)-alanine (**6**) is a commercially available compound, the derivatives of (*R*)- β -tyrosine (**4**) and 2-bromoabrine (**5**) are required for the synthesis of the tripeptide fragment **2**. These two unusual amino acid derivatives can be synthesized from available commercial starting materials by short routes.

Several syntheses of this metabolite have been reported.^{22a,23} However, within the scope of the general introduction of this thesis, the synthesis of jasplakinolide and the tripeptide are not the objective. Therefore, only a report that was published by the working group of T. Momose is presented.^{23c}

2.3.1 β -Tyrosine Derivative

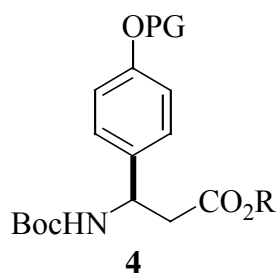

The β -tyrosine derivative can be prepared by multi-protection of the commercially available L-4-hydroxyphenylglycine (**7**). The synthesis was started with the treatment of **7** with $(\text{Boc})_2\text{O}$ in 0.5 *N* NaOH/dioxane (1:1). This was followed by the protection of the phenolic hydroxyl group to obtain the silyl ether **8** in 46% yield. Subsequently, **8** was treated with ethyl chlorocarbonate and followed by Arndt-Eistert's procedure with diazomethane to give the diazoketone **9** in 69%. The synthesis was continued by treatment of **9** with silver benzoate in *t*-butanol in the presence of Et_3N to produce the β -tyrosine derivative **4** in 50% yield.

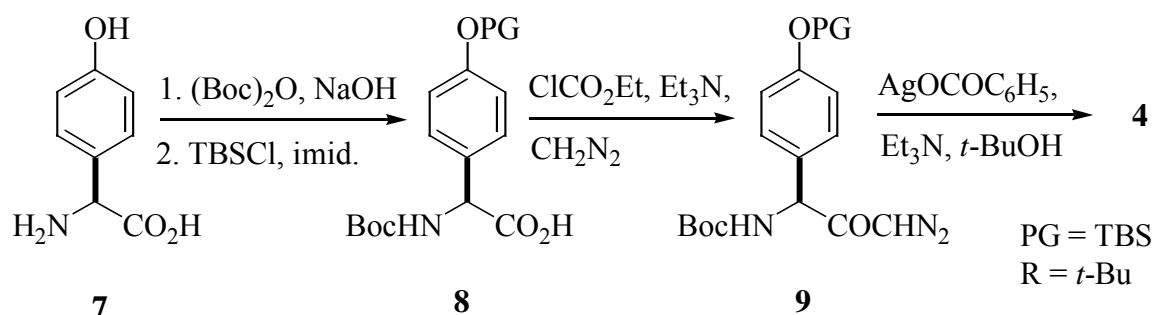

Scheme 2.2: The synthetic pathway to the protected β -tyrosine derivative (**4**).

The preparation of β -tyrosine derivatives by other short routes, such as from either α -tyrosine, benzaldehyde or cinnamic acid derivatives is also possible.^{22a,23b,23d,24}

2.3.2 2-Bromoabrine Derivative

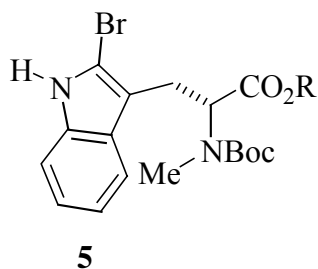

N-Boc-D-tryptophane (**10**) was initially used as a starting material for the route to the bromide-tryptophan derivative portion. The *N*-atom on the aromatic ring was protected by silylation with TBSCl followed by *N*-methylation to provide the completely protected ester **11** in 88% yield. Desilylation with TBAF and subsequent bromination using NBS in the presence of benzoyl peroxide provided the bromide derivative **5** in 90% yield.

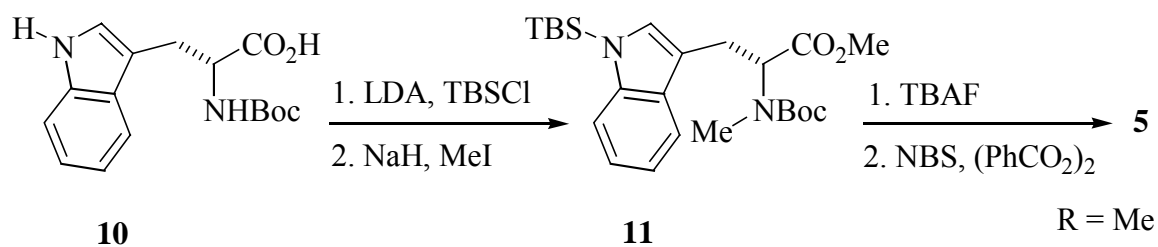

Scheme 2.3: The synthetic pathway to the protected 2-bromoabrine derivative **5**.

2.3.3 Tripeptide Fragment

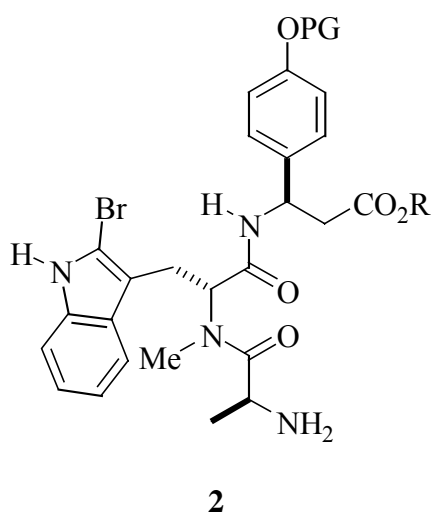

The synthetic pathway to obtain the tripeptide **2** started by selectively removing the *N*-*t*-Boc group in β -tyrosine derivative **4** with TBSOTf in CH₂Cl₂ to give the free amine **12**. The bromide tryptophan derivative **5** was hydrolyzed in 2*N* NaOH to give the corresponding carboxylic acid **13**. The coupling of **12** with **13** using DCC in the presence of HOBT produced the dipeptide **14** in 75% yield. The cleavage procedure of the Boc group was repeated in **14** with TBSOTf in CH₂Cl₂ to yield **15**. The coupling of **15** with *N*-Boc-L-alanine anhydride in CH₂Cl₂, in the presence of Et₃N, and the subsequent treatment with TBSOTf in the presence of 2,6-lutidine, gave the desired peptide **2** in 60% yield.

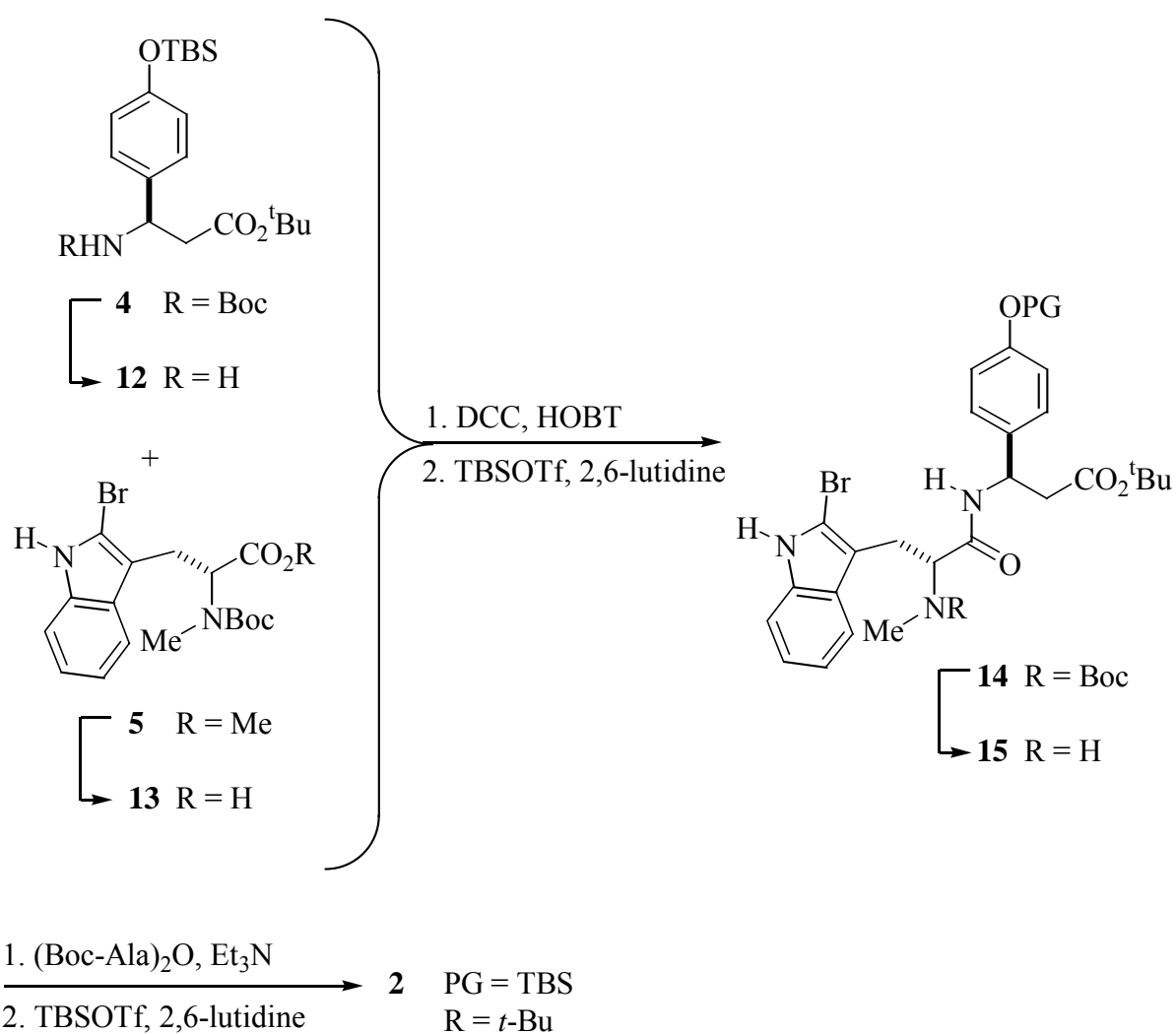

Scheme 2.4: The synthetic pathway to the tripeptide fragment **2**.

2.3.4 Macrolactonization of Jasplakinolide

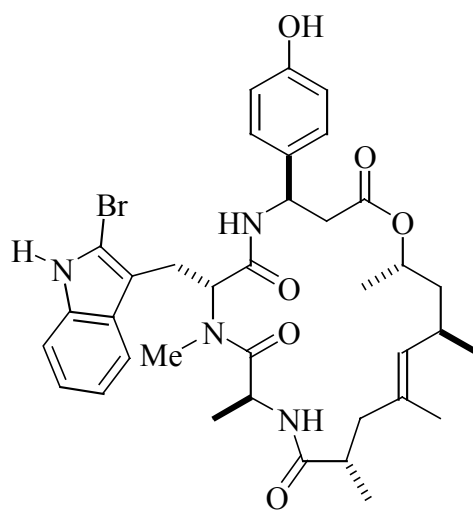

Jasplakinolide (**1**)

Jasplakinolide was synthesized by coupling of the tripeptide **2** and the polypropionate segment **3** with 1.05 equivalents of DCC and HOBT in THF, to provide the corresponding amide **16** in 81% yield. The cleavage of the *t*-butyl ester and partial desilylation in **16** were effected simultaneously by treatment with TFA in dimethyl sulfide-ethanedithiol-CH₂Cl₂ (3:4:20) at 0 °C, to give the hydroxy acid **17**. The lactonization of **17** was accomplished by Yamaguchi's procedure. Thus, treatment of **17** with 2,4,6-trichlorobenzoyl chloride in benzene, in the presence of Et₃N, followed by heating of the mixed anhydride with DMAP under reflux, gave the 19-membered compound in 82% yield. This reaction was followed by removal of the silyl group with TBAF in THF to result in (+)-jasplakinolide (**1**) in 93% yield.

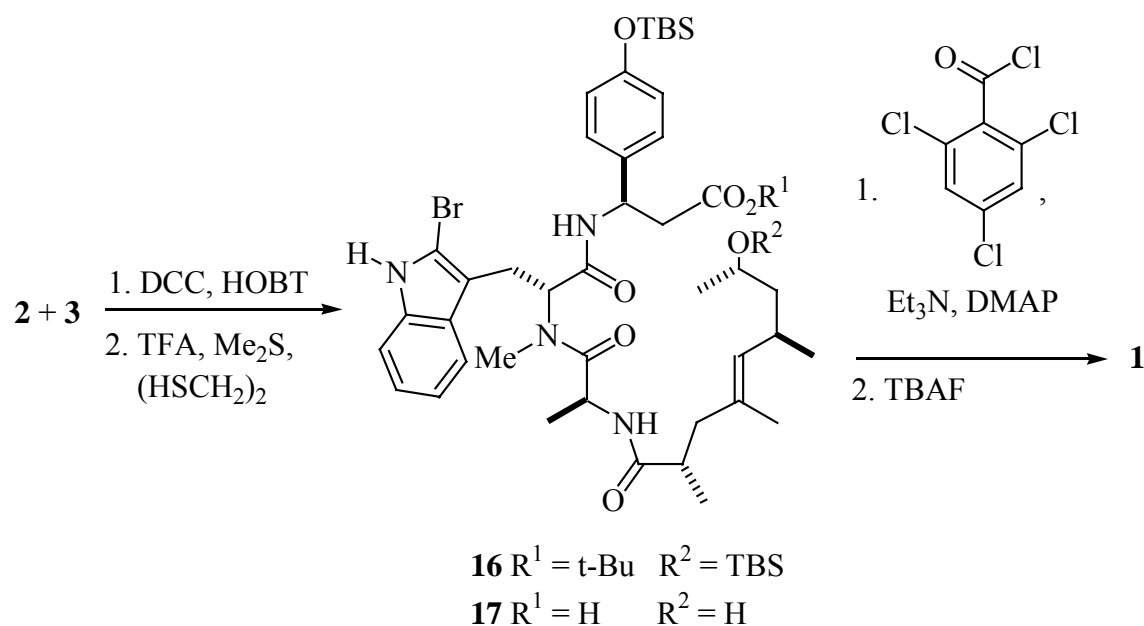

Scheme 2.5: The synthetic pathway to jasplakinolide (**1**).

Similar preparation methods for a total synthesis of jasplakinolide (**1**) and the tripeptide portion **2**, including protected β -tyrosine **4** and bromide-tryptophan derivatives **5** have been reported.^{22a,24,23a,25}

2.4 Synthesis of 8-Hydroxy-2,4,6-trimethyl-4-nonenoic acid

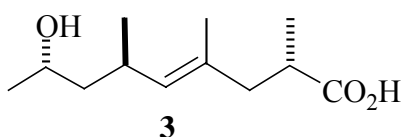

The first synthesis of the polypropionate unit was reported in 1988, two years after the discovery of jasplakinolide.³ The Grieco group announced the first total synthesis of jasplakinolide. According to their strategy jasplakinolide was constructed from dipeptide **15** and the L-alanine-polypropionate unit derivative. In the same year the Schmidt group reported the synthesis of this polypropionate unit as a precursor for the total synthesis of jasplakinolide and geodiamolide A and B. Because the methodology to accomplish the synthesis of this 11-carbon acid fragment has been extensively covered in literature, it is not possible to give all the details in this thesis. An overview of some publications is presented here to show the main reasons for undertaking this study.

2.4.1 The Grieco Group's Strategy (1988)^{22a}

The preparation of the **3b** derivative began with iodolactonization of **18** as the chiral starting material. The chiral acid **18** was readily available by resolution of the racemic acid with (-)- α -methylbenzylamine in ether. Reduction and protection of the primary hydroxyl group provided **19** in 63% yield. Conversion of the secondary hydroxyl group to a methoxy methyl ether, followed by desilylation and oxidation, resulted in the corresponding aldehyde **20**. The aldehyde **20** was directly treated with 2-propenylmagnesium bromide. The application of an ortho ester Claisen rearrangement to the resulting allylic alcohol generated a rearranged ester **21**. The ester **21** was hydrolyzed and transformed into the *N*-acyloxazolidine **22**. Alkylation of **22** with methyl iodide resulted in the desired diastereomer (71%). The chiral auxiliary was removed to give the corresponding carboxylic acid which was converted into the pyridinethiol ester **23**. Compound **23** was joined with the dipeptide **15** to give jasplakinolide.

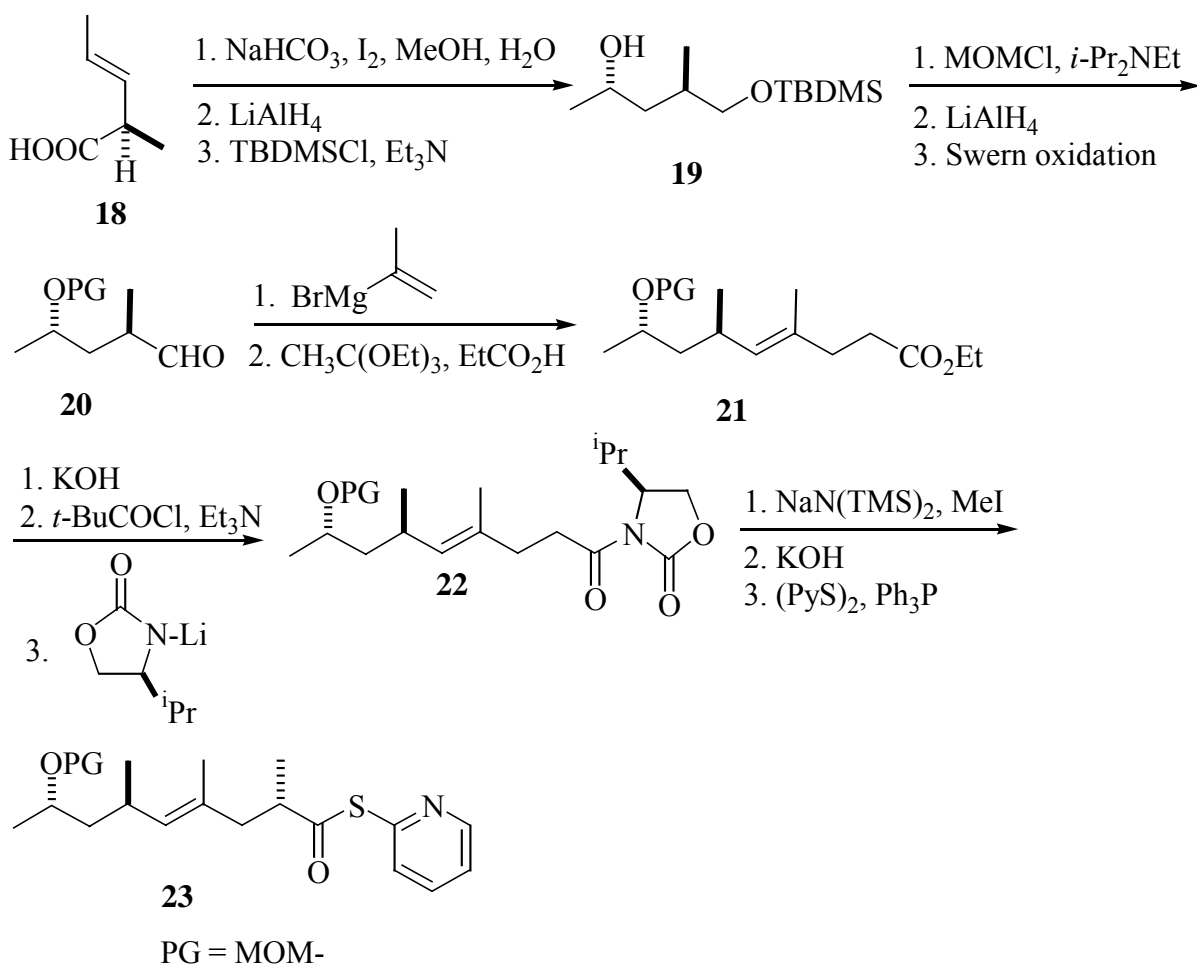

Scheme 2.6: Synthetic pathway to the polypropionate moiety derivative by Grieco.

2.4.2 The Schmidt Group's Strategy (1988)^{22b}

The synthetic route started with the alcohol **24** whose hydroxyl group was protected and the functional group changed to the alkyl iodide **25**. The asymmetric center in the 6-position was constructed by diastereoselective alkylation of the hydrazone from propanal, and (2*R*)-1-amino-2-methoxymethyl-pyrrolidine with the 1-iodopropane derivative **25**. After cleavage of the hydrazone of **26** with ozone, the resulting aldehyde **20** was allowed to react with isopropenylmagnesium bromide to form the diastereomeric allylic alcohols **27** and **28**, in a ratio of 68:32. The quantitative separation of the diastereomers was achieved by MPLC. The alcohols **27** and **28** were separately esterified to give **29** and **30** in 89% yield. The polyketide product **3b** was achieved by a Claisen ester enolate rearrangement.

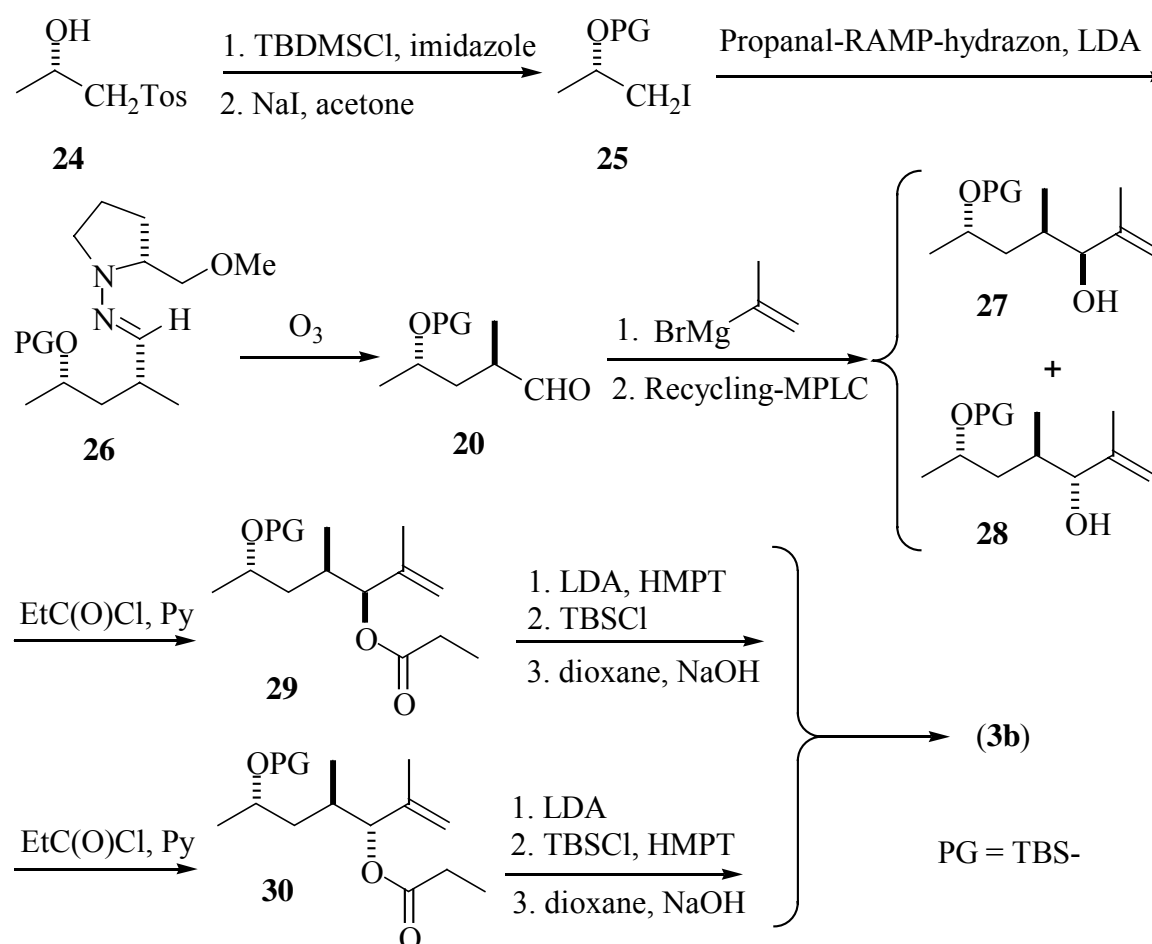

Scheme 2.7: Synthetic pathway to the polypropionate moiety derivative by Schmidt.

2.4.3 The White Group's Strategy (1989)²⁶

The preparation of the hydroxy acid moiety **3b** started from (4*S*)-4-methylbutyrolactone (**32**),²⁷ obtained from (*S*)-propylene oxide (**31**). α -Methylation of the lactone **32** gave **33**, which underwent hydrogenation to give (2*R*,4*S*)-cis-2,4-dimethylbutylolactone (**34**). Saponification of the lactone **34**, followed by silylation, gave **35**, which after reduction and oxidation provided the aldehyde **20**. Treatment of **20** with isopropenylmagnesium bromide furnished a mixture of diastereomeric allylic alcohols **27** and **28**. These both reacted with triethyl orthopropionate in the presence of propionic acid at 110 °C, producing a mixture of the ethyl esters **36**. The mixture was separated by HPLC, and subsequently hydrolyzed to give the acid fragment **3b**.

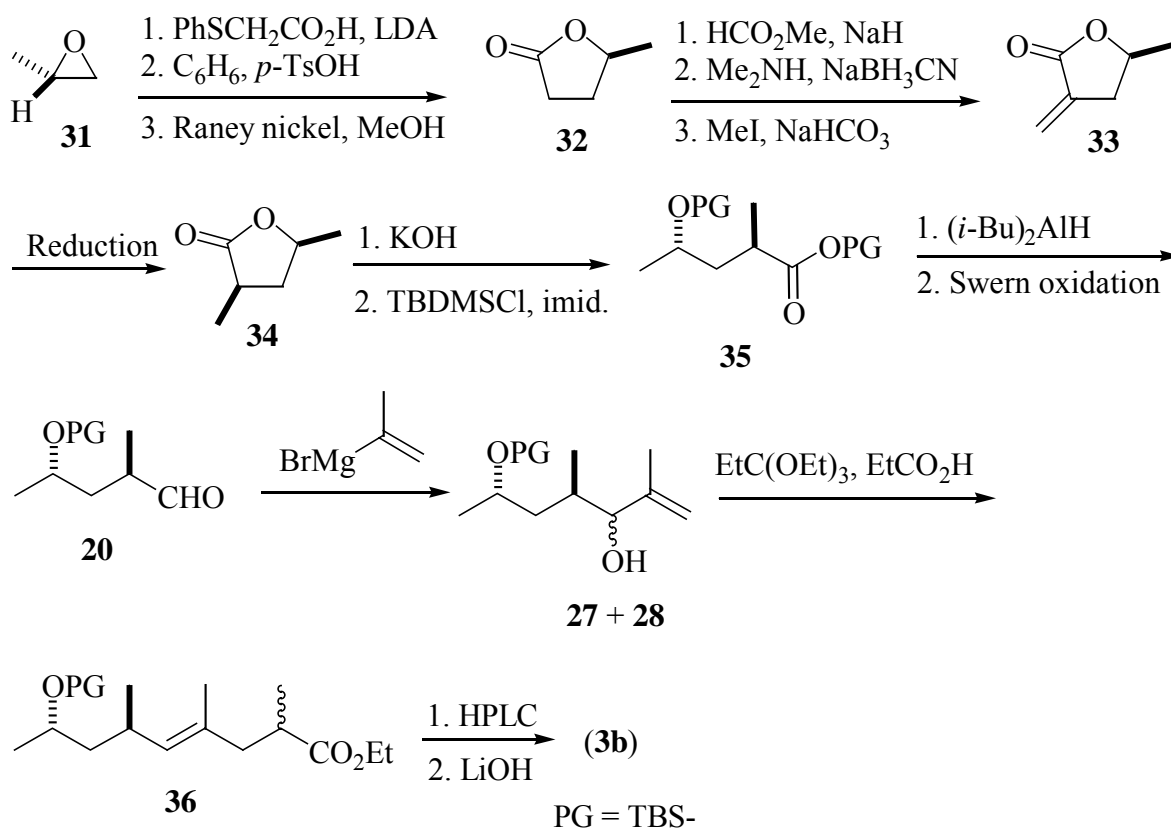

Scheme 2.8: Synthetic pathway to the polypropionate moiety derivative by White.

2.4.4 The Momose Group's Strategy (1989 and 1990)²⁸

The ring-opening of (*S*)-propylene oxide (**31**) with the dianion of propionic acid, gave a mixture of lactones **34** and **37**, as a mixture of diastereoisomers (ca 1:1) in 62% yield. Treatment of the mixture with LDA, and followed by protonation with (*1R*)-(-)-10-camphorsulfonic acid resulted in **34** and **37** (ca. 6.6:1). The mixture was reduced with DIBAL-H into lactols. The subsequent treatment of the resulting lactols with propanedithiol and boron trifluoride etherate gave the 1,3-dithiane derivative **38** in 58% yield along with its diastereoisomer in 8% yield. Silylation of **38** and oxidative hydrolysis of the thioacetal group resulted in the aldehyde **20**. Reaction of **20** with isopropenylmagnesium bromide gave a 1:1 mixture of diastereoisomeric alcohols in 95% yield. The mixture was converted to the desired isomer by Swern oxidation followed by reduction of the enone with Red-Al to give alcohol **28** in 72% yield. The alcohol **28** was then acylated with propionyl chloride. The resulting propionate **30** was subjected to an enolate Claisen rearrangement to give the polyketide acid **3b** in 77% yield, along with its epimer in 6% yield. This route actually is quite similar to the one published by White *et al.*

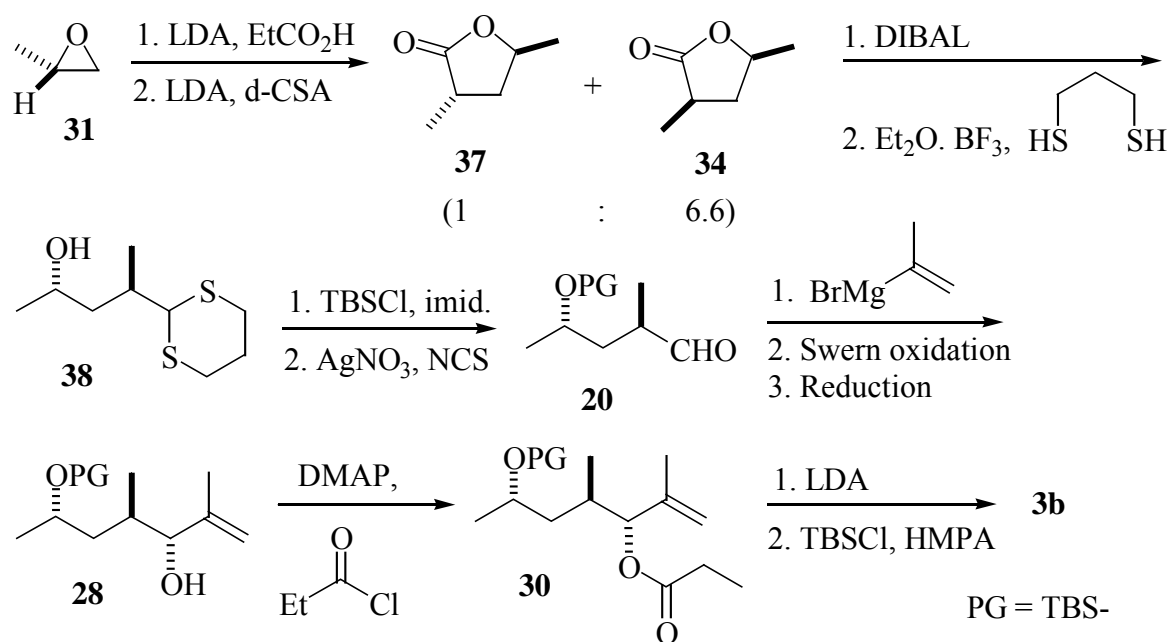

Scheme 2.9: Synthetic pathway to the polypropionate moiety derivative by Momose.

2.4.5 The Konopelski Group's Strategy (1991)^{25a}

The reaction of **18**^{22a} with iodine in methanol-water containing sodium bicarbonate produced the iodo γ -lactone which was subsequently dehalogenated to give the corresponding lactone **34**.²⁹ The lactone **34** was reduced with DIBAL-H prior to treatment with 2-lithio-2-propene. The resulting mixture of diol isomers **39** was directly subjected to the Eschenmoser variation of the Claisen rearrangement, and gave, after basic hydrolysis, the desired hydroxy acid along with the starting material. Protection of the secondary hydroxy functionality gave its TBS-derivative **40** in 94% yield. Use of the Evans auxiliary yielded **22**. Asymmetric methylation of compound **22** proceeded to a 3:1 mixture of isomers in 88% yield, separable by HPLC. The major isomer, obtained in 62% yield, was transformed to the corresponding carboxylic acid **3b** in 86% yield by treatment with LiOH/H₂O₂.

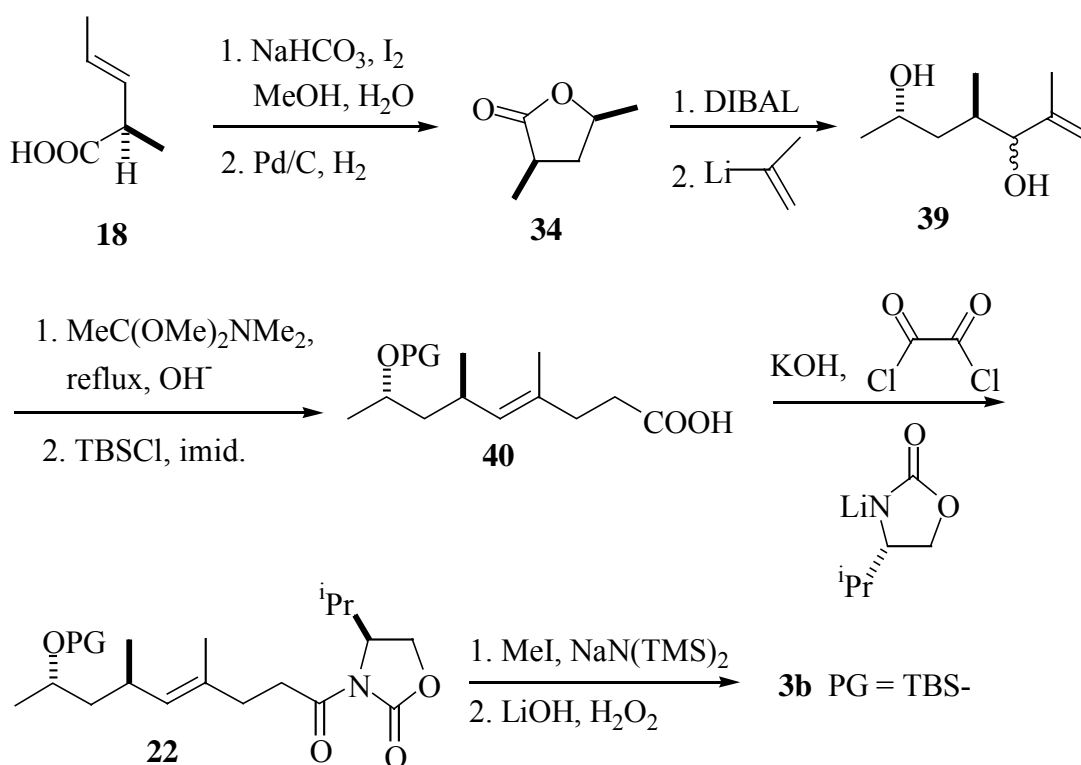

Scheme 2.10: Synthetic pathway to the polypropionate moiety derivative by Konopelski.

2.4.6 The Kang Group's Strategy (1991)³⁰

Aldehyde **41** was prepared in three steps from ethyl (*S*)-(-)-lactate.³¹ (*Z*)-Stereoselective Horner-Emmons olefination reaction of the aldehyde **41** with ethyl 2-

(dimethylphosphono)propionate and $\text{KN}(\text{TMS})_2/18\text{-crown-6}$ gave the (*Z*)-unsaturated ester **42**. The enoate **42** was treated with a catalytic amount of aqueous sulfuric acid (30%) to yield 2-(5*H*)-furanone (**43**) in 84% yield from **41**. Catalytic hydrogenation of **43** with $\text{Rh}/\text{Al}_2\text{O}_3$ as the catalysts gave the lactone **34**. Reduction of the lactone **34** with DIBAL-H and subsequent Wittig homologation of the intermediate lactol with ethyl (triphenylphosphorylidene)propionate, provided the trisubstituted olefin ester **44** in 64% yield from **34**. Conversion of **44** to **45** was achieved in 62% yield by protection of the alcohol **44** with TBDPSCl, followed by DIBAL-H reduction and treatment with phosphorus tribromide in the presence of pyridine. The allylic bromide **45** served then as an electrophile in the alkylation of the enolate derived from *N*-[(4*S*,5*S*)-4-methyl-5-phenyloxazolidinone]propionamide.

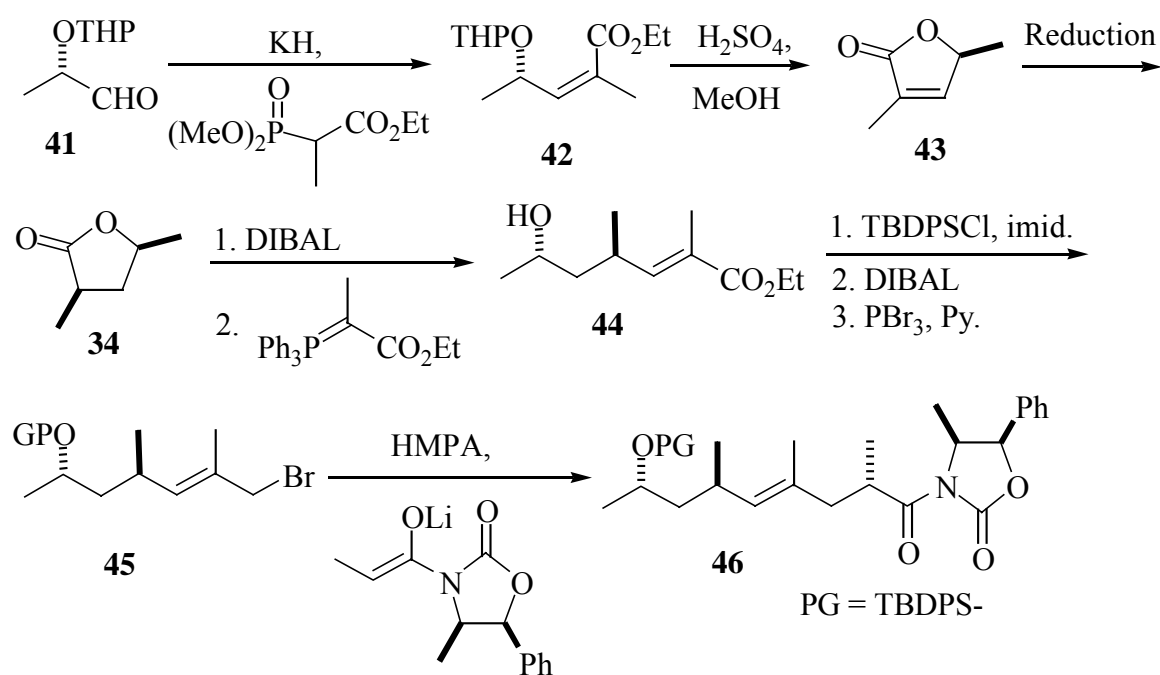

Scheme 2.11: Synthetic pathway to the polypropionate moiety derivative by Kang.

2.4.7 The Rama Rao Group's Strategy (1993)³²

This strategy uses the chiral (*R*)-2-methyl-4-pentenoic acid (**48**) as the building block. The racemic mixture of **48** was prepared from diethyl methylmalonate (**47**). The resolution of the racemic acid with *L*-phenylalaninol provided enantiomerically pure (*R*)-

48. The iodolactonization of (*R*)-**48** with I_2 - CH_2CN provided the lactone **49** as a major product, in 70% isolated yield. The lactone **49** was reduced with LAH to provide the diol **50**. The primary hydroxyl group of diol **50** was temporarily protected as a TBS ether, while the secondary hydroxyl group was converted into the benzyl ether to give **51** (58%). The deprotection of the silyl group and subsequent Swern oxidation yielded aldehyde **20**. Aldehyde **20** underwent a Wittig reaction, followed by reduction with DIBAL-H. The resulting unsaturated alcohol **52** was further manipulated by epoxidation with MCPBA leading to a single isomer. The hydroxyl group was converted to the corresponding iodo derivative **53**. The reductive elimination of the iodide **53** was followed by acylation with propionyl chloride to result in the propionate **30**. The acid **3b** was obtained from Ireland-Claisen rearrangement of **30**.

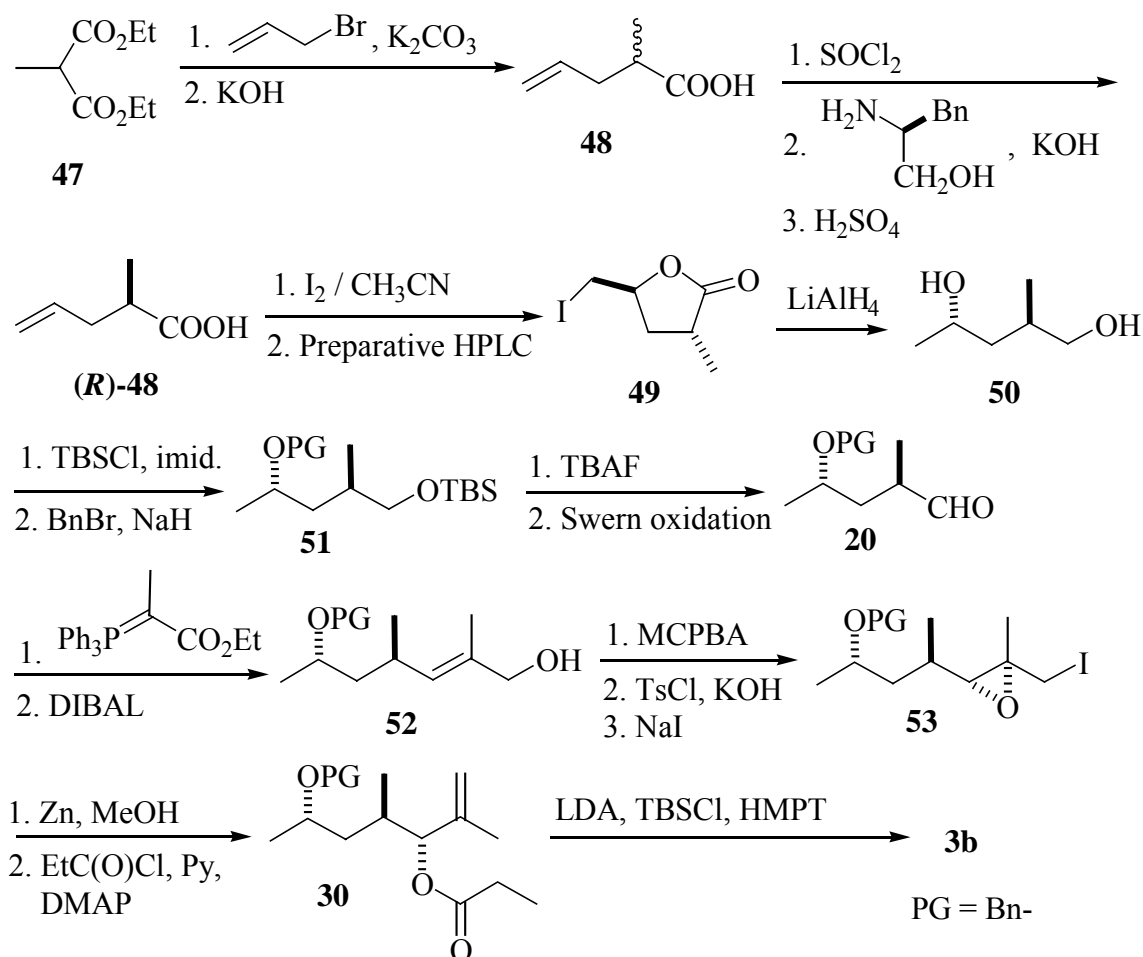

Scheme 2.12: Synthetic pathway to the polypropionate moiety derivative by Rama Rao.

2.4.8 The Shioiri and Hamada Group's Strategy (1994 and 1997)^{17,25b}

Commercially available (2*S*,4*S*)-2,4-pentanediol (**54**) was subjected to monosilylation with TBSCl, followed by tosylation with TsCl, resulting in the tosylate **55**. The reaction of the tosylate **55** with lithium cyanide in HMPA, afforded the cyanide **56** in good yield. This was accompanied with inversion of configuration. The reduction of the cyanide, followed by a Wittig reaction, yielded the (*E*)-unsaturated ester **57**. The ester was converted to the alcohol **52** with DIBAL-H in good yield. The replacement of the hydroxyl group with an iodide (I₂, imidazole, PPh₃, CH₃CN) quantitatively produced the photolabile iodide. The Evans asymmetric alkylation of the sodium enolate from the oxazolidinone with the iodide, gave the alkylated product **58** with a high diastereoselectivity (*E*:*Z*=96:4). Removal of the chiral auxiliary was easily achieved with lithium hydroxide-hydrogen peroxide to give the required polyketide **3b**, in an overall yield of 34% in 9 steps.

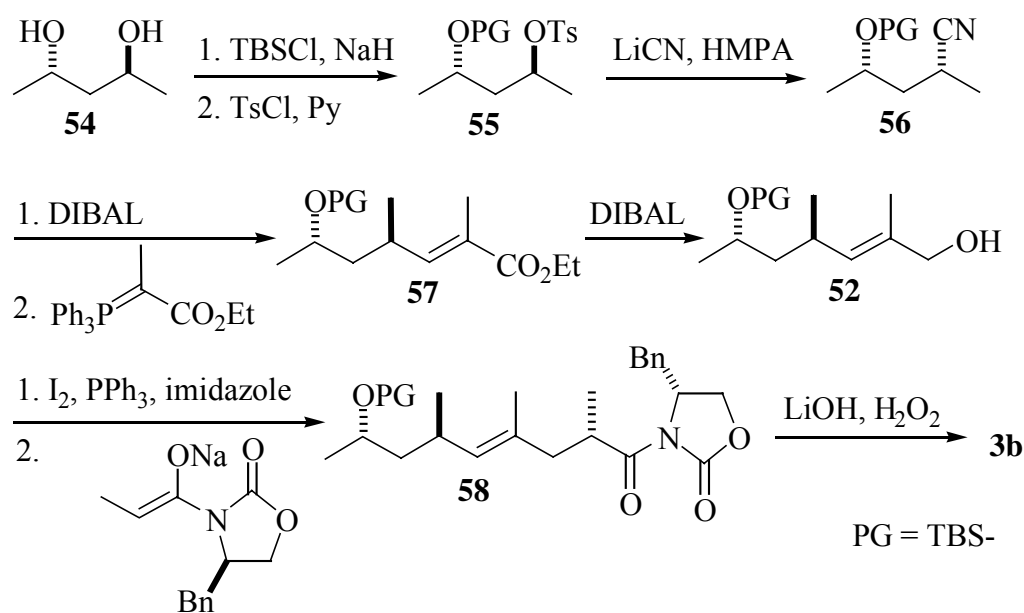

Scheme 2.13: Synthetic pathway to the polypropionate moiety derivative by Shioiri and Hamada.

An alternative strategy was published by the Kocienski group (1995).^{23d} They used a 1,2-metallate rearrangement of a metallated dihydropyran and a metallated enol carbamate derivative, as the key steps in the synthesis of the polyketide fragment **3b**. This route unfortunately gave a low yield of the desired product over many steps.

2.5 Critical Review and Reason for Undertaking This Study

Since the first publication of the synthetic pathway to the polypropionate unit **3b** in 1988 till this project began in 2001, various approaches to obtaining large-scale supplies of polyketide fragment **3** have been considered to construct either jasplakinolide or geodiamolides. In most of these approaches, the aldehyde **20** served as a key building block. For the extension of the carbon chain, the combination of the Grignard reaction with 2-propenylmagnesium bromide followed by a Claisen rearrangement is used frequently. Alternatively, the tactical sequence of a Wittig reaction followed by conversion to an allylic halide and asymmetric alkylation has been employed. The contribution of these approaches to the development of new methodologies and synthetic strategies has provided a large and valuable addition to synthetic methodology. In comparing the various routes, the synthesis of Shioiri (Scheme **2.13**) appears to be the most efficient route so far. It requires less steps, produces high yield and high selectivity. However, this strategy requires expensive starting materials. In addition, the end game that means the steps from alcohol **52** to the acid **3b** in the Rama Rao work appears to be highly original. Some other routes are too complicated to be utilized for large-scale production. An example is the requirement of MPLC or HPLC for the purification step. The remaining routes produce the desired acid **3** in low stereoselectivity or low yield over many steps of reaction.

2.6 Goal of Research

Jasplakinolide displays very interesting properties and is also used as an important biochemical tool. Although several syntheses of this metabolite had been reported when this project began, there were no reports where variations had been performed. This metabolite is ideally suited for modification due to its modular structure. Jasplakinolide is composed of the structural combination of the hydrophobic polypropionate and polar peptide chains. The interest for the construction of jasplakinolide, as well as others in the family of these novel biologically-active macrocycles, lies in the synthesis of the polypropionate fragment. While several syntheses of the acid moiety have been reported, they are still far from being economical and are unlikely to become a solution to the supply problem of jasplakinolide. This is why the preparation of the 8-hydroxy-2,4,6-trimethyl-4-

nonenoic acid (**3a**), the so-called “8-hydroxy acid of jasplakinolide” is an attractive although challenging option.

Consequently, the objective of this study is the development of a simpler procedure for the synthesis of the acid fragment and acid-like molecules, while attempting to find the most efficient of the methods. The discovery of a practical and useful new strategy requires that the key idea meets three important criteria:

1. The strategy should be “makeable or scaleable”. In other words, the reaction must take place easily with high stereoselectivity, high yield and absence of special requirements. It must also be able to provide the final target molecule in large scale production.
2. It must be practical. The reaction protocol must involve commercially available starting materials, reactants and catalysts which are inexpensive.
3. It must allow for easy modification and be applicable for the preparation of stereoisomeric and structural analogues. This means it must involve efficient enantioselective reactions to generate each of the stereo centers independently, offering maximum flexibility.

The approach is based upon the assumption that organic synthetic study is not merely the knowledge of how to approach the target molecule, but also to find simple solutions to complex synthetic problems. Frequently this leads to the discovery of new strategies, reagents, and reactions. This potentiality can be of great benefit to society.

In this study, the 8-hydroxy acid **3b** and analogues were investigated in order to couple with the tripeptide moiety, involving the total synthesis of jasplakinolide and jasplakinolide-like molecules.

3 RESULTS AND DISCUSSION

3.1 Retrosynthetic Analysis

From a retrosynthetic standpoint, one has to address the three chiral centers and the double bond configuration. The strategy underlying the synthetic plan was to apply efficient enantioselective reactions to generate each of the stereochemical centers independently. This would offer flexibility for the preparation of stereoisomeric and structural analogues. Moreover, the starting material should be cheap.

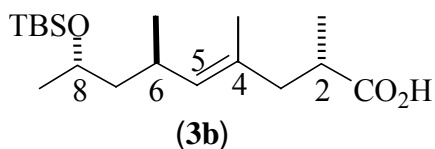

It is anticipated that the isolated *C2* stereocenter could be fashioned efficiently by employing an asymmetric Evans alkylation. The highly enantioselective induction is the reaction between enolates that are derived from an appropriate oxazolidinone and an alkyl halide precursor. Following previous publications, our plan was also designed to introduce the *C2* stereocenter at a late stage of the synthesis. Cleavage of the *C4-C5* olefin bond results in two allyl fragments. The union of these two moieties may be envisaged either via a Wittig conjugated system or metathesis coupling. Construction of the chiral center *C6* would present a challenging test to state-of-the-art techniques either from asymmetric cyclopropanation methodology followed by ring opening, or from diastereoselective methylation on a ring system. The secondary alcohol at the *C8* stereocenter, although it is certainly not obvious, could be installed by either selective alkylation of the aldehyde, or conversion from the corresponding ketone. All approached strategies for the synthesis of the polypropionate unit opted to build *C8* as a primary stereocenter. The synthetic plan as discussed in the retrosynthetic pathway is shown in Figure 3.1.

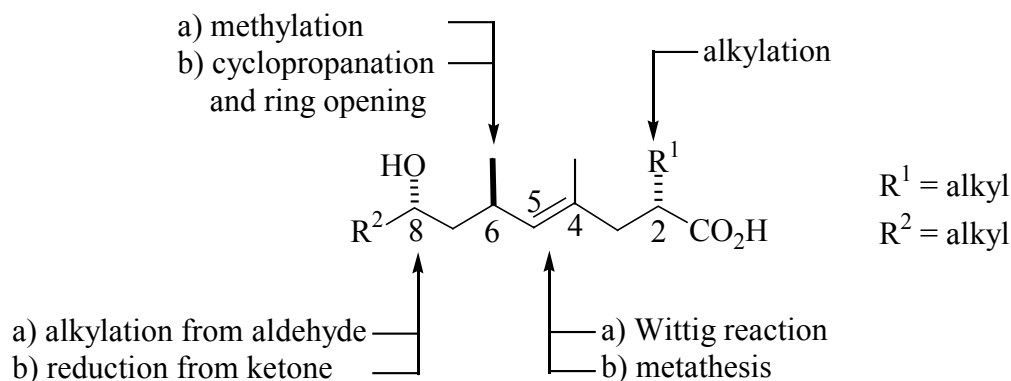
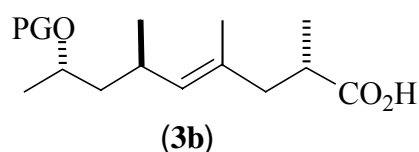

Figure 3.1: Structure and Retrosynthetic Analysis of (2*S*,4*E*,6*R*,8*S*)-8-hydroxy-2,4,6-trimethylnon-4-enoic acid (**3a**) derivatives.

In this study, the approached strategies are divided into routes A, B, C and D, according to the four different methods used to build the chiral C8 at the beginning of the strategy.

3.2 Synthetic Pathway to the 8-Hydroxy Acid of Jasplakinolide

-ROUTE A



In our initial retrosynthetic analysis for the construction of the required target molecule four key reaction steps were planned. They are an asymmetric reduction of ethyl acetoacetate (**64**) by yeast for formation of the first chiral center C8, then a Charetté method: an asymmetric cyclopropanation of the double bond followed by ring opening for introducing a methyl group at C6, then a Wittig reaction for formation of the double bond at C4-C5 which would take place after the reductive opening of an (iodomethyl) cyclopropane, and an Evans alkylation as a means of stereoselective introduction of the last methyl substituent into this system at C2. The sequence leading to the 8-hydroxy-2,4,6-trimethylnon-4-enoic acid derivative (**3b**) is shown in Scheme 3.1.

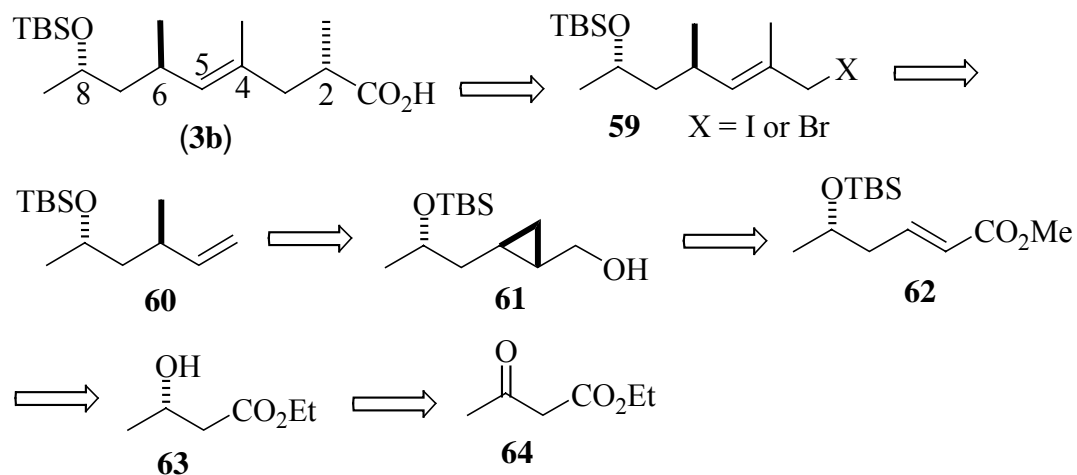

Scheme 3.1: Retrosynthetic analysis of (2*S*,4*E*,6*R*,8*S*)-8-*tert*-Butyl(dimethyl)silyloxy}-2,4,6-trimethylnon-4-enoic acid (**3b**).

Key Reactions and Mechanisms

3.2.1 Bakers' Yeast Enantioselective Reduction

Saccharomyces cerevisiae is commonly known as "bakers' yeast" or "brewers' yeast".³³ The yeast ferments sugars present in the flour or added to the dough, giving off carbon dioxide (CO₂) and alcohol (ethanol). For organic chemistry bakers' yeast is an interesting biocatalyst, which is easily accessible in the laboratory and can catalyze highly enantioselective reductions.³⁴

Bakers' yeast is able to reduce variously substituted carbonyl groups to the corresponding hydroxy compounds. The source of the hydride is basically glucose-6-phosphate. The stereochemical outcome of these reactions generally follows the so-called Prelog's rule³⁵ and leads to the (*S*)-alcohols (Scheme 3.2).

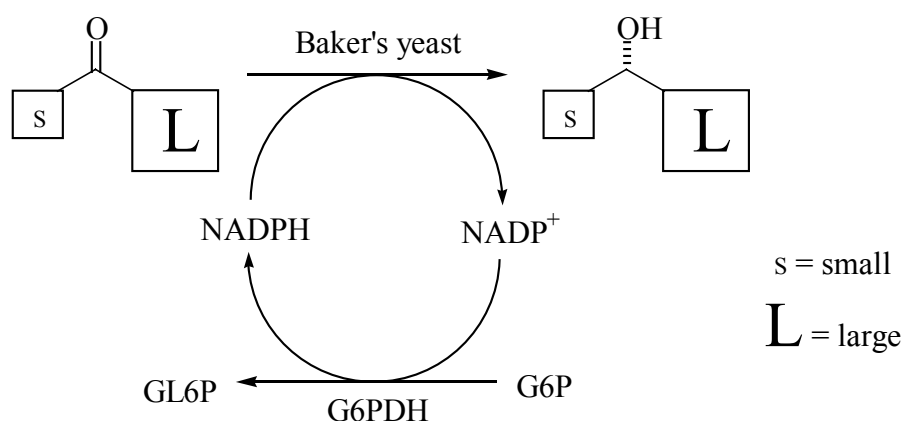

G6P: glucose-6-phosphate

GL6P: glucono- δ -lactone-6-phosphate

G6PDH: glucose-6-phosphate dehydrogenase

NADP⁺: β -Nicotinamide-adenine dinucleotide phosphate

NADPH: β -Nicotinamide-adenine dinucleotide phosphate, reduced

Scheme 3.2: Asymmetric reduction of carbonyl compounds mediated by bakers' yeast.^{34b}

β -Ketoesters are one of the thoroughly studied carbonyl compounds and generally react with good enantioselectivity, depending on the volume of substituents. In this family of compounds, Prelog's rule is suitable for predicting the selectivity in the event of a change of substituents. A decrease in the size of R¹ and an increase in the size of R² generally enhance L-selectivity, while a bulkier R¹ shifts reduction in favor of the D-enantiomer (Scheme 3.3).

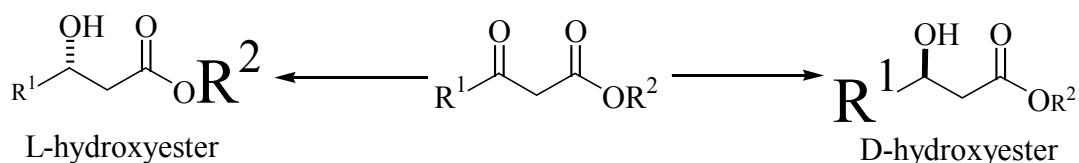

Scheme 3.3: Change of enantioselectivity as depending on the volume of R¹ and R².^{34a}

Table 3.1: Enantioselective preparation of some β -hydroxy esters from the corresponding β -keto esters by baker's yeast reduction.^{34b, 36}

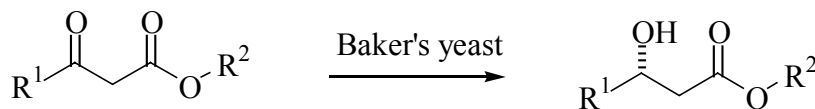

Entry	R ¹	R ²	Yield (%)	ee (%) ^a
1	Me	Me	49	97
2	Me	Et	57-76	84-87
3	Me	<i>n</i> -Bu	58	90
4	Me	<i>t</i> -Bu	61	85
5	Et	Et	67	- 40
6	<i>n</i> -Bu	Et	-	- >90

Note: a) The values for entries 5 and 6 are listed as negative numbers because baker's yeast reduction yields the opposite enantiomer as the major product.

3.2.2 Enantioselective Cyclopropanation of Allylic Alcohols

A reaction between iodomethylzinc iodide and an olefin that produces a cyclopropane compound was first reported by Simmons and Smith. It is now called the Simmons-Smith (SS) reaction.³⁷ The iodomethylzinc iodide as the original Simmons-Smith reagent was prepared from CH₂I₂ and metallic zinc. The modification, wherein the insoluble zinc-copper couple is replaced by diethylzinc, is used widely in organic synthesis. The new reagent can provide better reproducibility, greater substrate variety, and faster reactions.³⁸

The addition of suitable chiral ligands to the SS reaction leads to the asymmetric synthesis of cyclopropanes.³⁹ These chiral auxiliaries have been divided into two classes. They are the zinc-based carbenoid reagents and the transition metal-based carbenoid reagents. There are numerous auxiliary-based methods such as tartrate-derived acetal **65**, disulfonamide **66**, and dioxaborolane **67**. These catalysts generally provide high levels of diastereoselectivity.⁴⁰

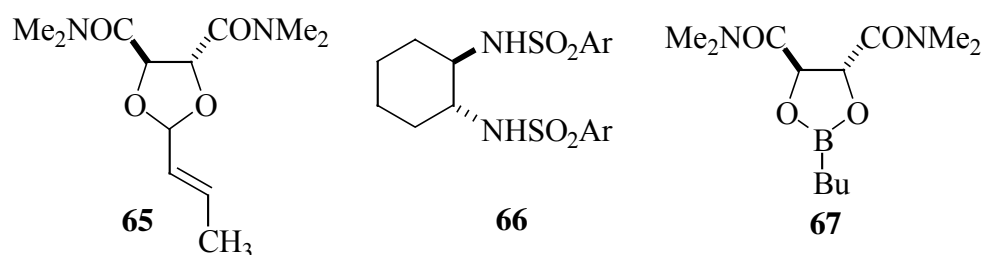

Figure 3.2: Structures of acetal **65**, disulfonamide **66**, and dioxaborolane **67**.

The SS reagents with an allylic alcohol have distinct advantages over the reaction with a simple olefin with regard to the reaction rate and stereocontrol.⁴¹ Much of the development of enantioselective zinc-based cyclopropanation has relied upon the effect of an allylic alcohol functional group to provide a locus for reagent tethering and control.⁴² The use of stoichiometric quantities of chiral additives to modify the reagent has also met with considerable success.⁴³ Among this type of reaction, dioxaborolane **67** is a notable example.

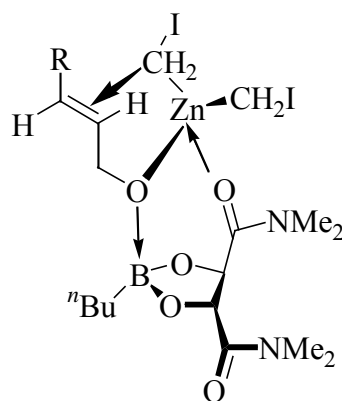
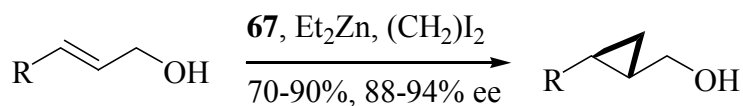

Figure 3.3: Transition state model for cyclopropanation of allylic amide **67**.⁴⁴

The use of a stoichiometric quantity of the chiral dioxaborolane **67** with allylic alcohol leads to the formation of cyclopropanes in high yield and high enantiomeric excess. The iodomethylzinc reagent, which is formed *in situ* by the reaction of diethylzinc and diiodomethane, interacts with the chiral dioxaborolane enabling the synthesis of enantioenriched cyclopropanes.



Scheme 3.4: Charette asymmetric cyclopropanation with the chiral catalyst **67**.⁴⁵

3.2.3 Cross Metathesis (CM)⁴⁶

Olefin metathesis is a powerful method for the formation of carbon-carbon double bonds.⁴⁷ It can be described as a reaction in which all the carbon-carbon double bonds in an olefin (alkene) are broken and then rearranged in a statistical fashion (Scheme 3.5). If one of the product alkenes is volatile (such as ethylene) or otherwise easily removed, the reaction shown below can be completely driven to the product side.

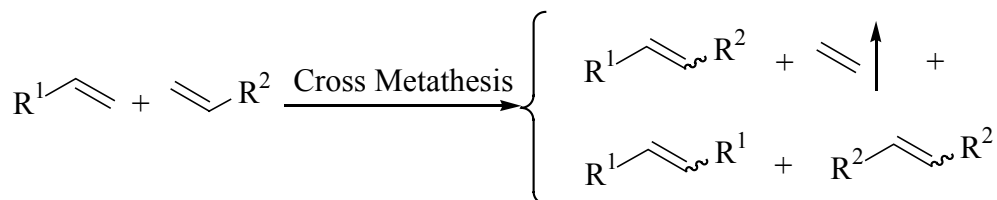

Scheme 3.5: Cross metathesis reaction.⁴⁸

Grubbs⁴⁹ and others⁵⁰ have broadened the scope of olefin metathesis and done extensive mechanistic work for the improvement of defined substrate and functional group tolerant ruthenium based metathesis catalysts. The activity of the “first-generation” ruthenium metathesis catalyst (**68**) was significantly improved with the “second-generation” catalyst (**69**) where an *N*-heterocyclic carbene replaces one phosphane group.^{49,50a-b} Both first and second generation Grubbs catalysts were studied in this project. As a general consideration for the ranking of olefin reactivity in CM, olefins can be categorized according to the products they give with the two Grubbs catalysts. In this regard, olefins can belong to one of these four categories.⁴⁸

Table 3.2: Reactivity of alkenes with first and second generation Grubbs catalysts.⁴⁸

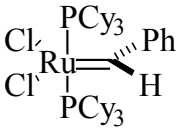
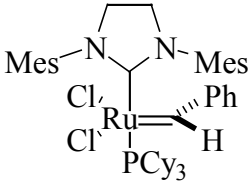
Olefin Type	 <p style="text-align: center;">Grubbs I catalyst (68)</p>	 <p style="text-align: center;">Grubbs II catalyst (69)</p>
Type I	Terminal olefins, allyl silanes, 1° allylic alcohols, ethers, esters, allyl boronate esters, allyl halides	terminal olefins, 1° allylic alcohols, esters, allyl boronate esters, allyl halides, styrenes (no large ortho substituted), allyl phosphonates, allyl silanes, allyl phosphine oxides, allyl sulfides, protected allyl amines
Type II	styrene, 2° allylic alcohols, vinyl dioxolanes, vinyl boronates	styrenes (large ortho substituted), acrylates, acrylamides, acrylic acid, acrolein, vinyl ketones, unprotected 3° allylic alcohols, vinyl epoxides, 2° allylic alcohols, perfluorinated alkane olefins,
Type III	vinyl siloxanes	1,1-disubstituted olefins, non-bulky trisubstituted olefins, vinyl phosphonates, phenyl vinyl sulfone, 4° allylic carbons (all alkyl substituents), 3° allylic alcohols (protected)
Type IV	1,1-disubstituted olefins, disub. α,β -unsaturated carbonyls, 4° allyl carbon-containing olefins, perfluorinated alkane olefins, 3° allyl amines (protected)	vinyl nitro olefins, trisubstituted allyl alcohols (protected)

The Proposed Rules (Guidelines)⁴⁸

Type I: rapid homodimerization, homodimers consumable.

Type II: slow homodimerization, homodimers sparingly consumable.

Type III: no homodimerization.

Type IV: olefins inert to CM, but do not deactivate catalyst (Spectator)

Rule:

reaction of two alkenes from Type I: statistic CM

reaction of two alkenes from same Type (non-Type I): nonselective CM

reaction of two alkenes from different Type: selective CM

The mechanism for olefin metathesis by ruthenium carbene catalysis is consistent with Chauvin's metallacyclobutane mechanism.⁵¹ The principal steps involve the initial dissociation of a (phosphane) ligand from the 16 valence electron (VE) starting complex **A** to form the 14 VE active species **B**. After ruthenium had less coordination, a transition metal carbene forms π complex **C** by coordination of an olefin. The metallacyclobutane intermediate **D** is then obtained by a formal [2+2] cycloaddition. After the [2+2] cycloreversion, the olefin product is released from the olefin π complex **E**. The 14 VE active species **F** can either re-enter into the catalytic cycle or be trapped by a phosphane (complex **G**).

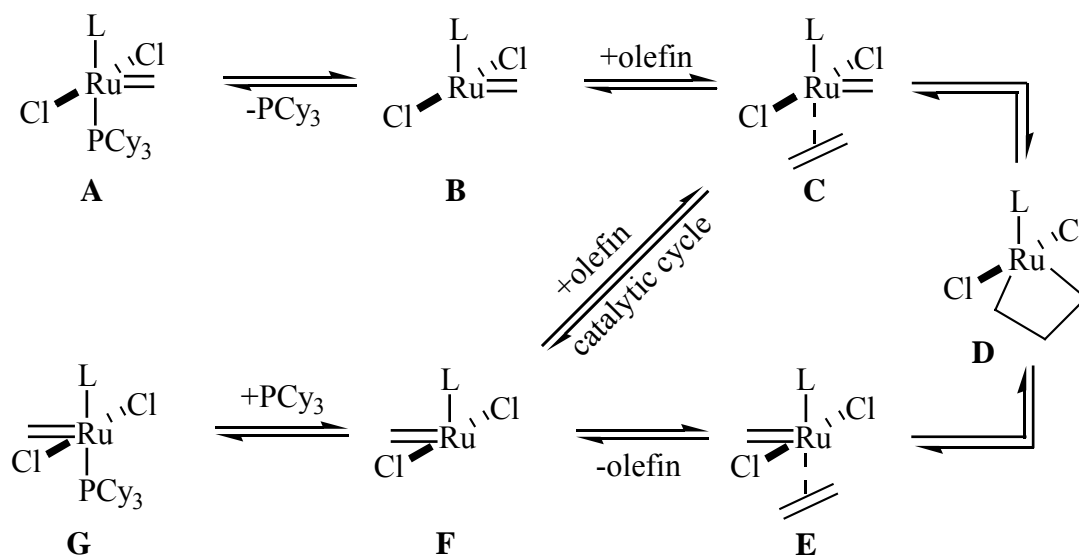

Scheme 3.6: Mechanism of olefin metathesis.⁵²

3.2.4 Stereoselective Enolate Alkylation

The versatile oxazolidin-2-one based chiral auxiliary methodology was first developed by Evans *et al.*⁵³ The auxiliaries are easy to prepare from α -amino acids. For instance chiral oxazolidin-2-ones **70-73** are available from valine, phenylalanine, phenylglycine, and norephedrine, respectively.⁵⁴



70 R = CHMe₂

71 R = PhCH₂

72 R = Ph

73

The auxiliary has been utilized in a wide variety of synthetic transformations such as asymmetric aldol condensation, stereoselective alkylation, stereoselective differentiation of enantiotopic groups in molecules bearing prochiral centers, and other interesting applications.⁵⁵ For example, it has been widely used for the asymmetric synthesis of homochiral α -substituted carboxylic acids.⁵⁶

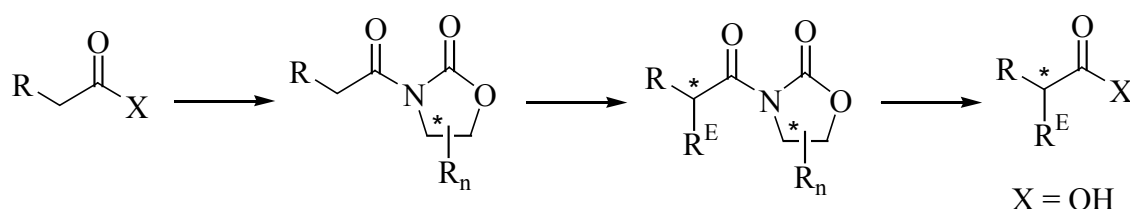

Scheme 3.7: Synthesis of homochiral α -substituted carboxylic acids using oxazolidin-2-one chiral auxiliaries.⁵⁷

In this study, *N*-acyloxazolidin-2-one **75** derived from D-phenylalanine (**74**) was employed to control the asymmetric alkylation of enolate.⁵⁸ The enolization of imide **75** with NaN(SiMe₃)₂ is known to generate a *Z*-enolate **76**.⁵⁹ The sodium enolate **76** comprises two distinct *p*-faces (*re* and *si* face) because the sodium ion coordinates to both the *N*-acyl and the oxazolidinone carbonyl oxygens. The *si*-face is difficult to access for electrophiles because of the steric hindrance of the aromatic substituent as shown in Figure 3.4.

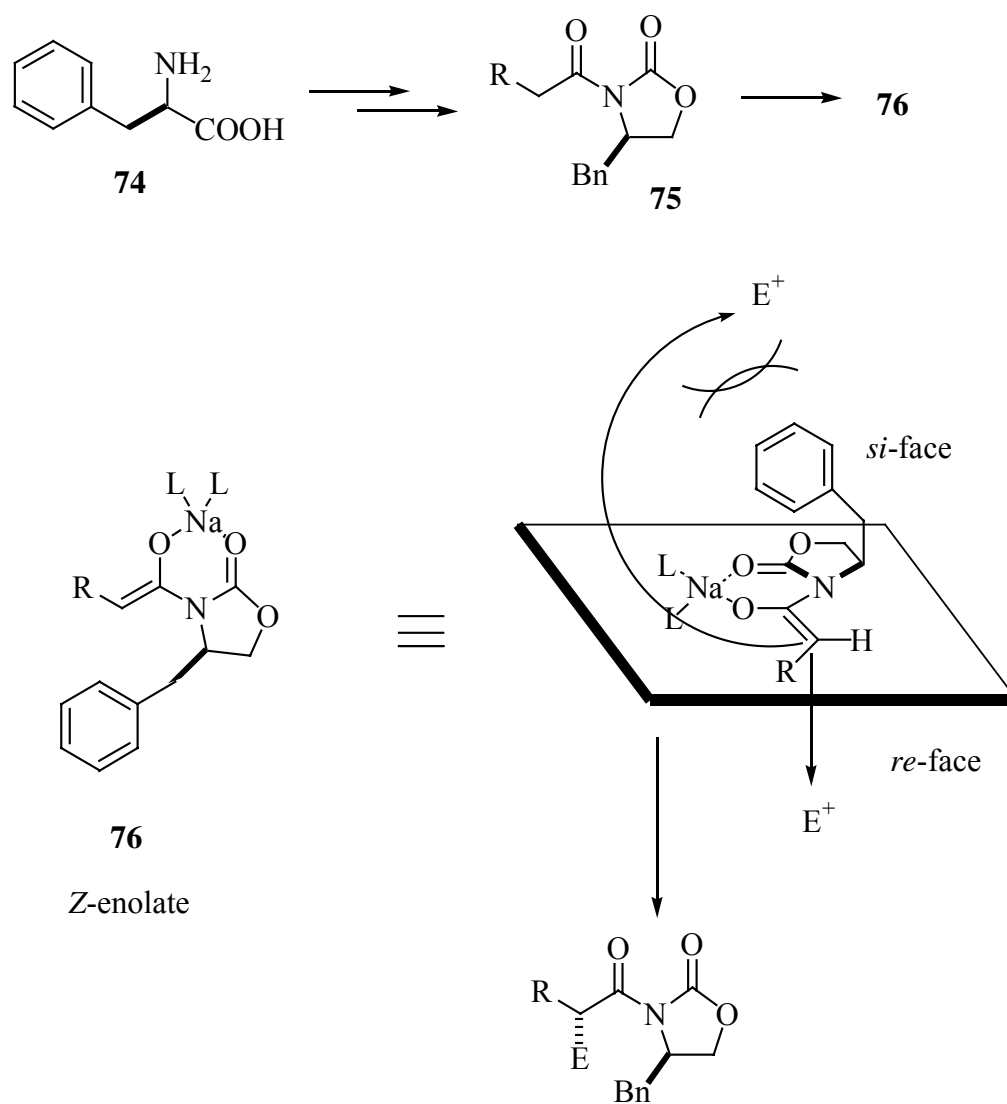
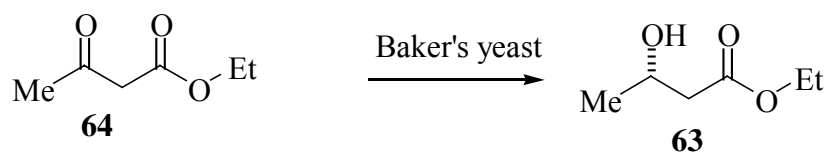

Figure 3.4: Transition states of the Evans alkylation.^{55b,60}

Synthetic Pathway

The first synthetic pathway started by yeast reduction of acetoacetate **64**.³⁶ (see 3.2.1 Baker's Yeast Enantioselective Reduction) Two types of yeast were studied for building the first chiral center under both aerobic and anaerobic conditions as shown in Table 3.3.

Table 3.3: Studies on baker's yeast reduction.



Entry	Baker's Yeast	Condition	Yield (%)	ee (%) ^d
1	Fresh ^a	Aerobic	73	89
2	Fresh ^a	Anaerobic ^c	32	91
3	Powder ^b	Aerobic	14	59
4	Powder ^b	Anaerobic ^c	52	84

Note: a) Backhefe DHW Vital Gold; Deutsche Hefewerke GmbH & Co. ORG Nürnberg

b) RUF Hefe, RUF; Lebensmittelwerk KG D-49610 Quakenbrück.

c) The reaction was performed in an erlenmeyer flask with bubble counter.

d) The enantiomeric excess values (ee) were measured by GC.

The fresh baker's yeast under aerobic condition (entry 1), which gave the best result, was selected for the synthesis of the chiral 3-hydroxy ester **63**. A subsequent silylation of the hydroxy ester with *tert*-butyl-dimethylsilyl chloride (TBSCl) in the presence of imidazole gave the known compound **78**.⁶¹ Reduction with diisobutylaluminium hydride (DIBAL-H) provided the aldehyde^{61a,62} **79** that was converted to the enoate⁶³ **62** by reaction with the stabilized Wittig reagent (Ph)₃P=CHCO₂Me (**80**).⁶⁴ Reaction of the enoate **62** with 2.2 equivalents of DIBAL-H furnished the allylic alcohol **81**.⁶⁵ In order to introduce a methyl group at position C6 of the target hydroxy acid **3** we used the reductive opening of an (iodomethyl)cyclopropane. Accordingly, the allylic alcohol was converted to the hydroxymethylcyclopropane **61** using a combination of

diiodomethane, diethylzinc and the chiral dioxaborolane **67** (Charetté method).⁴² (see 3.2.2 Enantioselective Cyclopropanation of Allylic Alcohols) Since a direct conversion of the primary alcohol to the corresponding iodide (I₂, imidazole, PPh₃, CH₃CN) was not a clean reaction, the pathway via the mesylate **82** was followed. Treatment of the mesylate **82**, obtained from the alcohol **61** with mesyl chloride and triethylamine, with NaI in acetone gave the iodide **83** in excellent yield.⁶⁶ The reductive ring opening⁶⁷ of **83** was achieved with *n*-butyllithium in THF between -78 and -30 °C resulting in the alkene **60** with 73% yield. According to the ¹³C NMR spectrum, this compound was diastereomerically pure (> 98%).

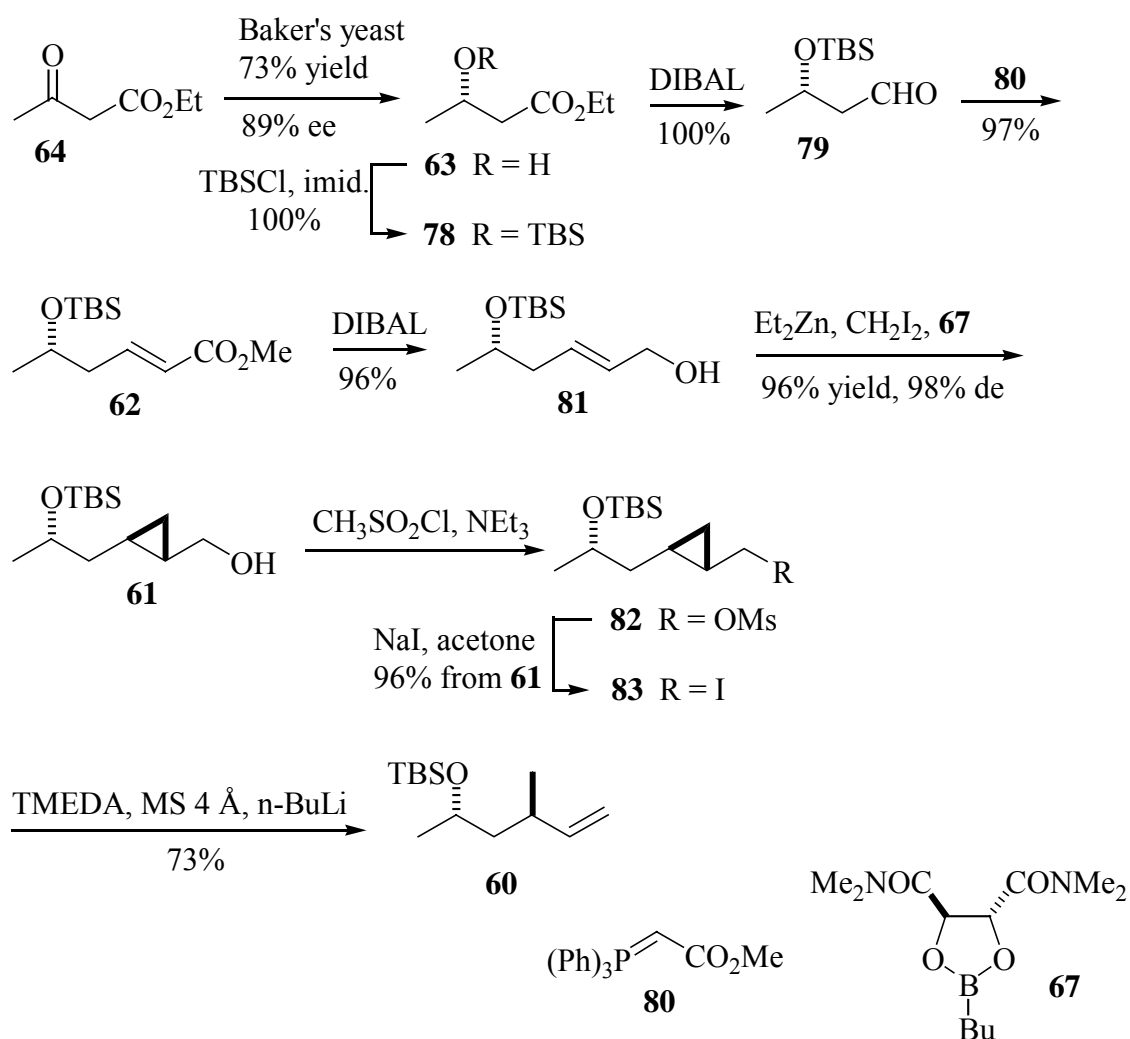

Scheme 3.8: Synthesis of the key building block **60**.

The preparation of the dioxaborolane ligand **67** as a chiral auxiliary for cyclopropanation began with (2*R*,3*R*)-2,3-dihydroxy-*N,N,N',N'*-tetramethylsuccinamide **85**.⁶⁸ The succinamide **85** was prepared from (L)-diethyl tartrate (**84**) as the chiral starting material.⁶⁹ The Grignard reaction of trimethyl borate (**86**) with butylmagnesium bromide followed by hydrolysis with 10% hydrochloric acid afforded butylboronic acid (**87**) in 74% yield. The butylboronic acid was treated with diethanolamine in the presence of molecular sieve 3 Å to afford 2-butyl-1,3,6,2-dioxazaborocane (**88**). The dioxazaborocane **88** was stirred with the previously prepared succinamide **85** under inert atmosphere at room temperature to give the chiral auxiliary **67**.

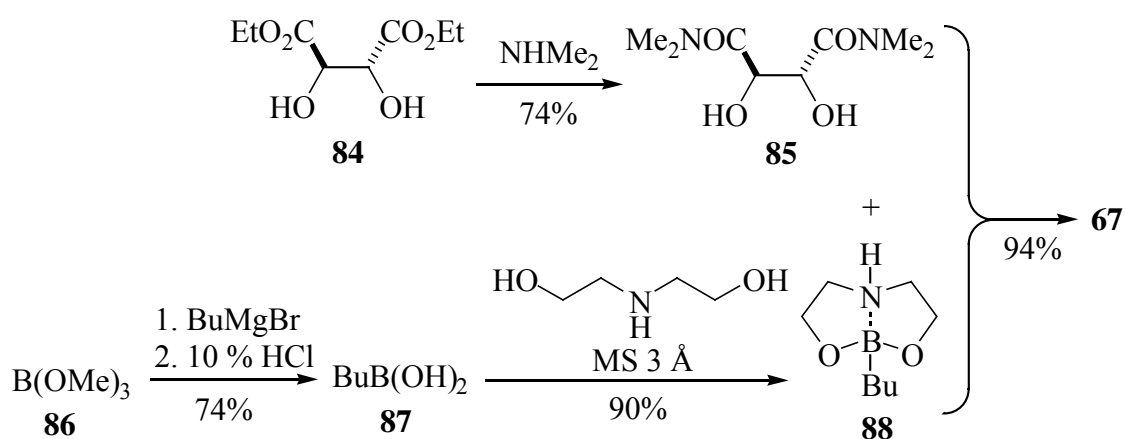

Scheme 3.9: Synthesis of the chiral auxiliary **67**.

For the extension of the alkene **60** to the enoate **91** we initially used the sequence of ozonolysis and Wittig reaction.⁷⁰ The Wittig reaction of the resulting aldehyde **20** with the stabilized ylide⁷¹ **90** yielded the enoate ester **91**. However the ozonide **89** proved to be rather stable and its reductive cleavage with dimethyl sulfide (2 mL/mmol of **60**) in CH_2Cl_2 required stirring for 1 week. The one-pot cleavage and Wittig-reaction also did not work.⁷²

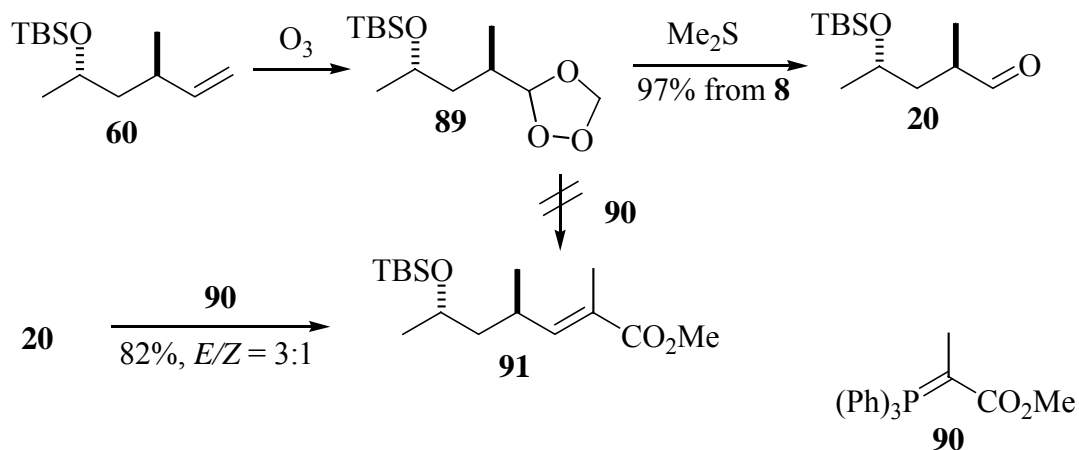

Scheme 3.10: Synthesis of the enoate **28** by Wittig reaction from key building block **60**.

Therefore we opted for the direct conversion of the alkene **60** to the enoate **91** by alkene cross metathesis.⁴⁸ (see 3.2.3 Cross Metathesis) We set out to study first the reactivity of the alkene **60** with methyl methacrylate (**92**) in the presence of the Ru-based catalysts **68** or **69** in CH_2Cl_2 (Table 3.4).

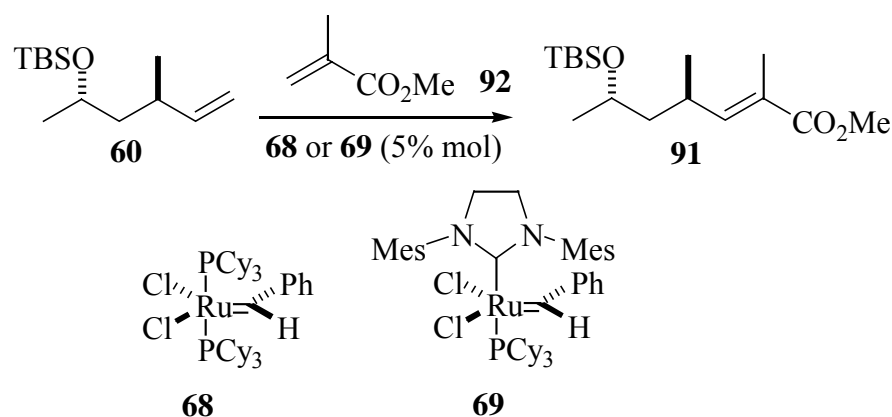
Table 3.4: The preliminary study for the cross-metathesis of the alkene **60**.

Entry ^a	Catalyst	Solvent	Temperature (°C)	Alkene 92 (eq.)	Yield 91 ^b (%)
1	68	CH ₂ Cl ₂	40	1.5	traces
2	69	CH ₂ Cl ₂	40	1.5	30
3	68	CH ₂ Cl ₂	40	20	traces
4	69	CH ₂ Cl ₂	40	20	51
5	69	toluene	70	10	48

Note: a) Reaction performed on a small scale.

b) *E* isomer exclusively.

A preliminary experiment was carried out with 5 mol% of the ruthenium catalyst **68**, 1 equivalent of the alkene **60** and 1.5 equivalents of methyl methacrylate (**92**). The reaction took place under reflux at 40 °C in CH₂Cl₂. We found that under these conditions the desired product **91** was only obtained in traces (entry 1). In the presence of catalyst **69**, the reaction afforded the desired compound in 30% yield (entry 2). Afterwards the reactions were performed, under the same conditions, in the presence of catalyst **68** and an excess of methyl methacrylate (20 equivalents). Under these conditions the CM product **91** was again only obtained in traces (entry 3). In the presence of catalyst **69** the reaction yielded the desired product in 51% yield (entry 4).

The Ru-based catalyst **68** always provided the enoate **91** only in traces. Therefore, we opted to use Grubbs II catalyst **69** for alkene cross metathesis of the olefin **60** with methyl methacrylate (**92**). For the best production of the desired compound **91** with 5 mol% of the Grubbs II catalyst (**69**), the proper reaction conditions were sought.

Olefin cross-metathesis (CM) is a thermodynamically controlled reaction that is complicated by statistical product distributions and a mixture of olefin stereoisomers. During the course of this preliminary study we also assessed the reactivity of methyl methacrylate (**92**) towards alkene **60** in different solvents and at different temperatures. The reactions were performed in toluene at 70 °C in the presence of catalyst **69**. Under these conditions the CM product **91** was isolated as a single stereoisomer (*E* only) in 48% yield (entry 5). This result is similar to those obtained in CH₂Cl₂ at 40 °C (entry 2 and 4).

In the preliminary experiment the dimer of **60** from homodimerization was observed as the side product of cross metathesis. In order to achieve a higher cross metathesis product yield, the conversion of the starting material **60** into the cross-metathesis product **91** was explored with 1 equivalent of the alkene **60** combined with several equivalents of methyl methacrylate (**92**) in the presence of 5 mol% of catalyst **69**. The results are listed in Table 3.5.

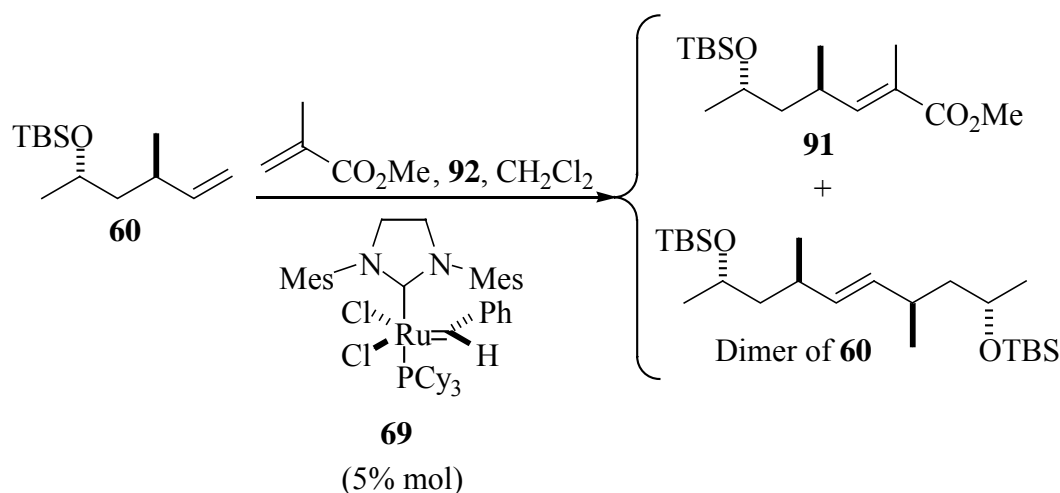
Table 3.5: Optimization study for the CM of alkene **60** based on equiv. of alkene **92**.

Entry	Equiv. of Methyl methacrylate	% Yield		
		Product 91	Dimer of 60	Combined yield
1	1.5	30	56	86
2	5	43	42	85
3	10	73	17	90
4	15	55	23	78
5	20	51	10	61

The use of only 1.5 equivalents of methyl methacrylate (**92**) resulted in the formation of only 30% of product **91** along with 56% of homodimerisation of **60** (entry 1). The reaction with an excess amount of methyl methacrylate (**92**) resulted in less homodimerisation of the alkene **60** and more of the desired cross-metathesis product **91** (entries 2 and 3). Particularly noteworthy is the result of the reactions using higher excess of methyl methacrylate (**92**) that provided less of the desired CM product **91** (entries 4 and 5). Indeed a 73% yield of the CM product **91** was attained by reacting compound **60** with 10 equivalents of **92** in the presence of 5 mol% of catalyst **69**. Only 55 and 51% yields of the CM product **91** were observed when alkene **60** was reacted with 15 and 20 equivalents of **92** respectively.

Accordingly optimal results were obtained by performing the reaction of the alkene **60** and 10 equivalents of methyl methacrylate (**92**) in CH_2Cl_2 under reflux at 40 °C with 5 mol% of Grubbs catalyst **69**.

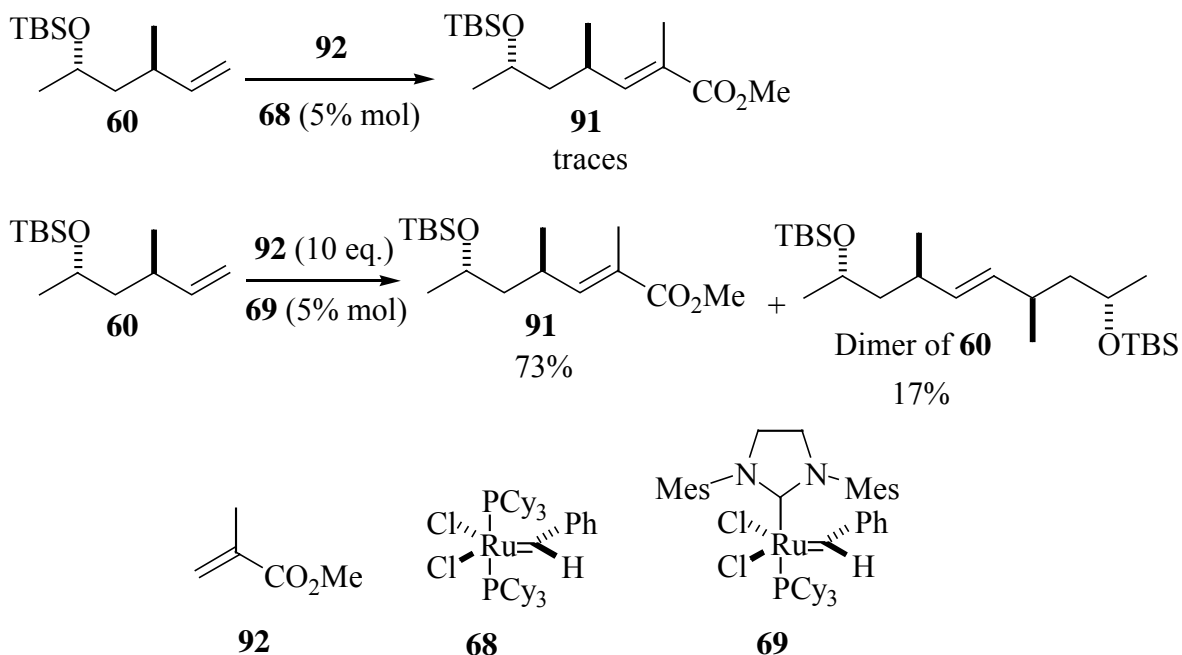

Scheme 3.11: Synthesis of the enoate **91** by cross coupling metathesis from olefin **60**.

The dimer of **60**, a by-product from the study, was recovered by ozonolysis⁷⁰ back to compound **89**, followed by transformation shown in Scheme 3.10. The remaining steps to the desired acid were performed in a similar way as described in literature. Thus, reduction of ester **91** to alcohol **93**, followed by conversion to the allylic mesylate **94** and substitution of the mesylate with iodide delivered the iodide **59** in good overall yield for the three steps.^{17,30} Besides the mesylate **94**, the corresponding allylic chloride **95** is also formed in a yield of less than 10%. For analytical purposes the mesylate and chloride were separated, however the mixture can be used as such for the next step. The iodide **59** was then used as the electrophile in an Evans alkylation⁵⁹ with the propionyloxazolidinone **75**.⁵⁸ (see 3.2.4 Stereoselective Enolate Alkylation) The absolute configuration of the alkylation product **96** was determined by a final hydrolysis of the alkylation product **96** to the known TBS-protected hydroxy acid **3b** in quantitative yield.^{17,22,23a-b,d,28b,30,32}

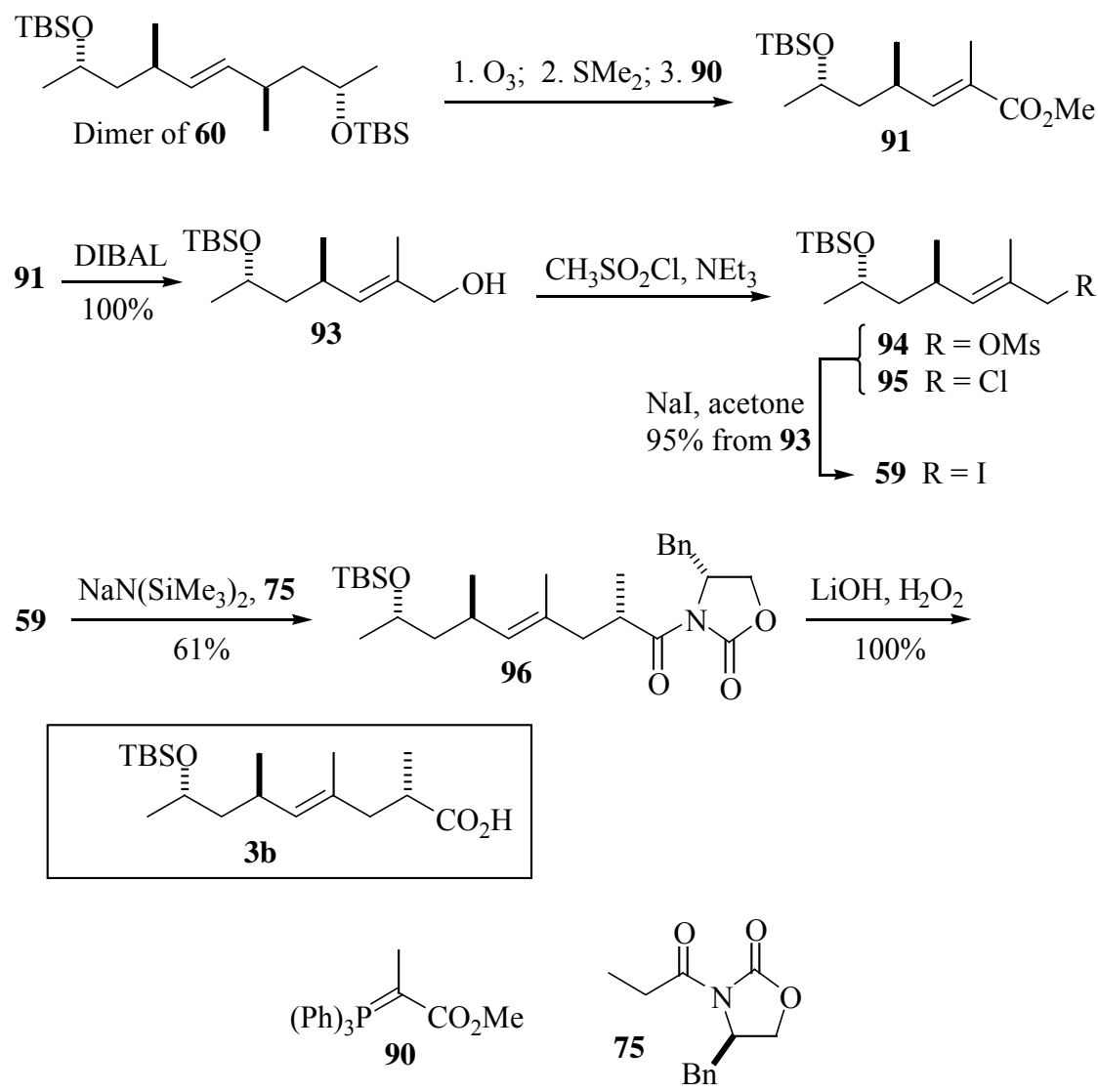

Scheme 3.12: Synthesis of hydroxy acid **3b** from the alkene **60**.

The carboximide **75** as a chiral auxiliary for alkylation was prepared from D-phenylalanine.⁵⁸ The preparation began with a direct reduction of (*R*)-phenylalanine (**74**) with borane. The resulting amino alcohol **97** was transformed into oxazolidinone **98** by condensation with diethyl carbonate in the presence of catalytic amounts of potassium carbonate. Further deprotonation with *n*-butyllithium and subsequent acylation with propionyl chloride afforded the desired propionyloxazolidinone **75** in good overall yield for the three steps.

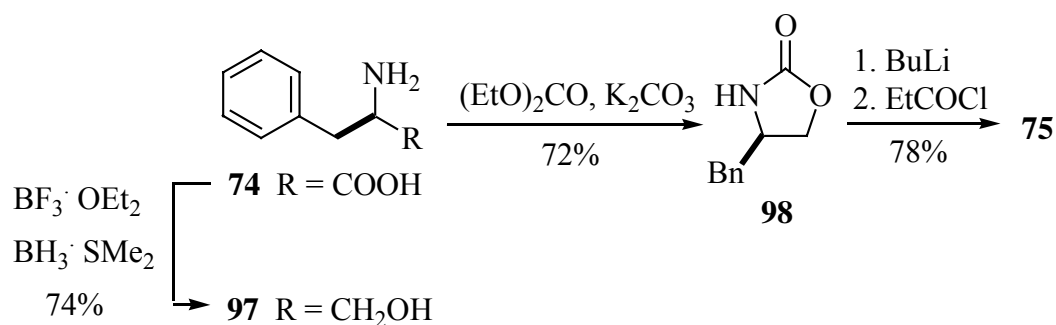

Scheme 3.13: Synthesis of the chiral auxiliary propionyloxazolidinone **75**.

After successfully synthesizing **3b**, an improvement of the strategy was explored. Since the cross metathesis combines two alkenes, it offers the possibility of a shorter synthesis. Ideally the completed right part might be connected to alkene **60**. (see 3.2.3 Cross Metathesis) Thus, some terminal 2-methyl olefins were arranged for a demonstration.

The chiral propionyloxazolidinone **75** was treated with 3-bromo-2-methylpropene (**99**) in an Evans alkylation⁵⁹ to provide the olefin⁷³ **100**. (see 3.2.4 Stereoselective Enolate Alkylation) The alkylated product was converted to alkenes **101**⁷⁴, **102**⁷⁵ and **103**⁷⁶. Further silylation of the alcohol **103** with *tert*-butyl-dimethylsilyl chloride (TBSCl) in the presence of imidazole provided the TBS-protected alkenol^{76d} **104** in quantitative yield.

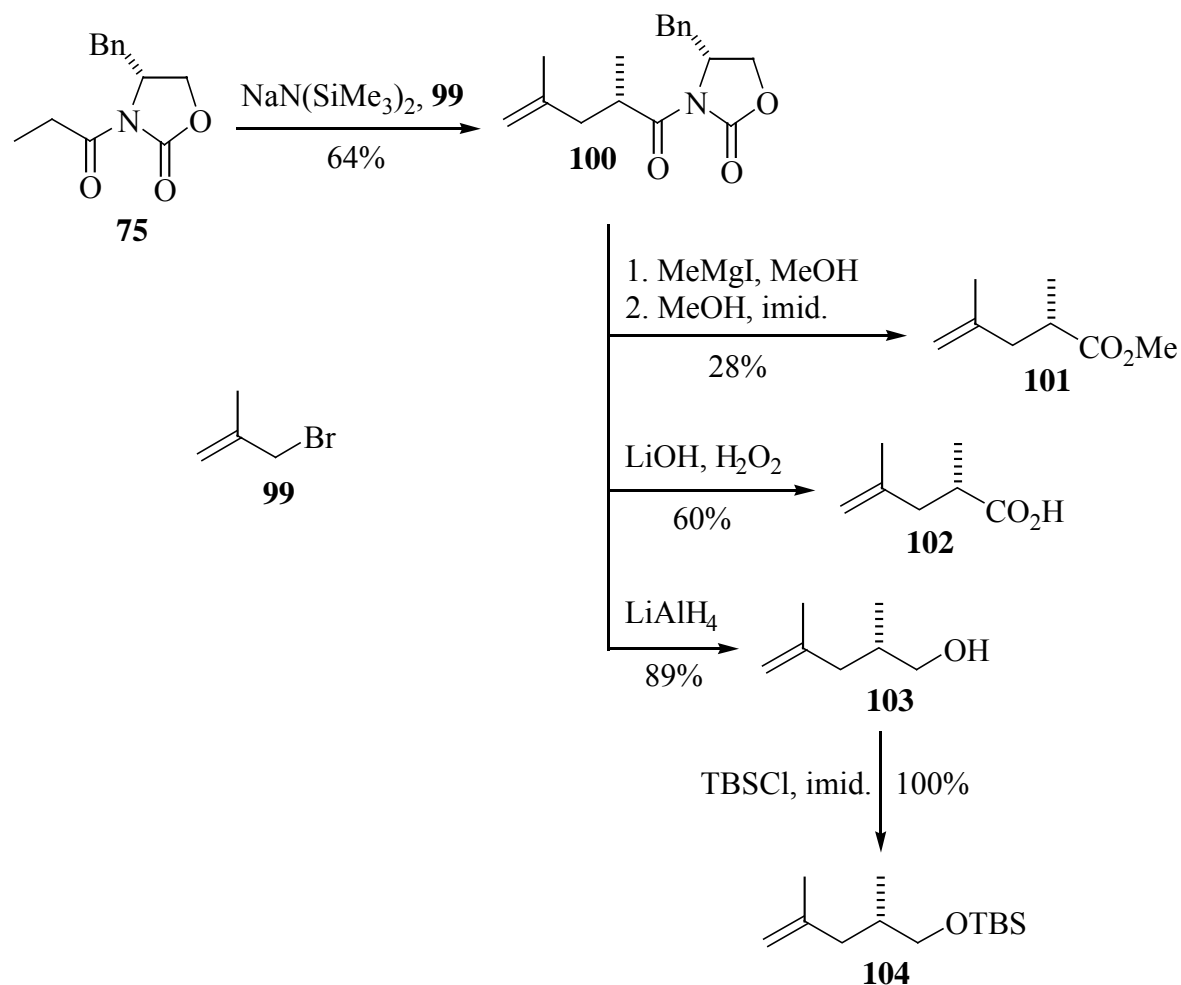

Scheme 3.14: Preparation of the chiral 2-methyl olefins **100-104** from oxazolidinone **75**.

The first idea was to try the coupling of alkene **60** with acid **102** via metathesis with Grubbs catalyst II (**69**) to directly yield the final product **3b**. Unfortunately, there was no reaction. At the end of the procedure, only a mixture of two starting materials (**60** and **102**) was present. The result could be anticipated because the carboxylic group of olefin **102** might deactivate the Grubbs catalyst. The next attempt took a step back to compound **96** by coupling of alkene **60** with olefin **100**. After a couple experiments, the observed products were only the dimer of **60** and the starting material **100**. This failed synthesis might be caused by the low reactivity of alkene **100**. According to Table 3.2 alkenes **100-104** are type III olefins with Grubbs II catalyst and probably show a low inherent reactivity.

Afterwards an intensive investigation of metathesis cross coupling of alkene **60** with four different 2-methyl allyl compounds (**101**, **103**, **104** and **99**) was performed. After several attempts under different conditions, more surprising results were observed. In all reactions, only a mixture of alkene **60**, the starting 2-methylallyl compound, and the dimer

of **60**, but none of the desired product was observed. This result indicates that the formation of the desired product via cross coupling metathesis technique requires a suitable 2-methyl-olefin, which might need to have an electron withdrawing substituent. According to our study only methyl methacrylate (**92**) was a possible candidate.

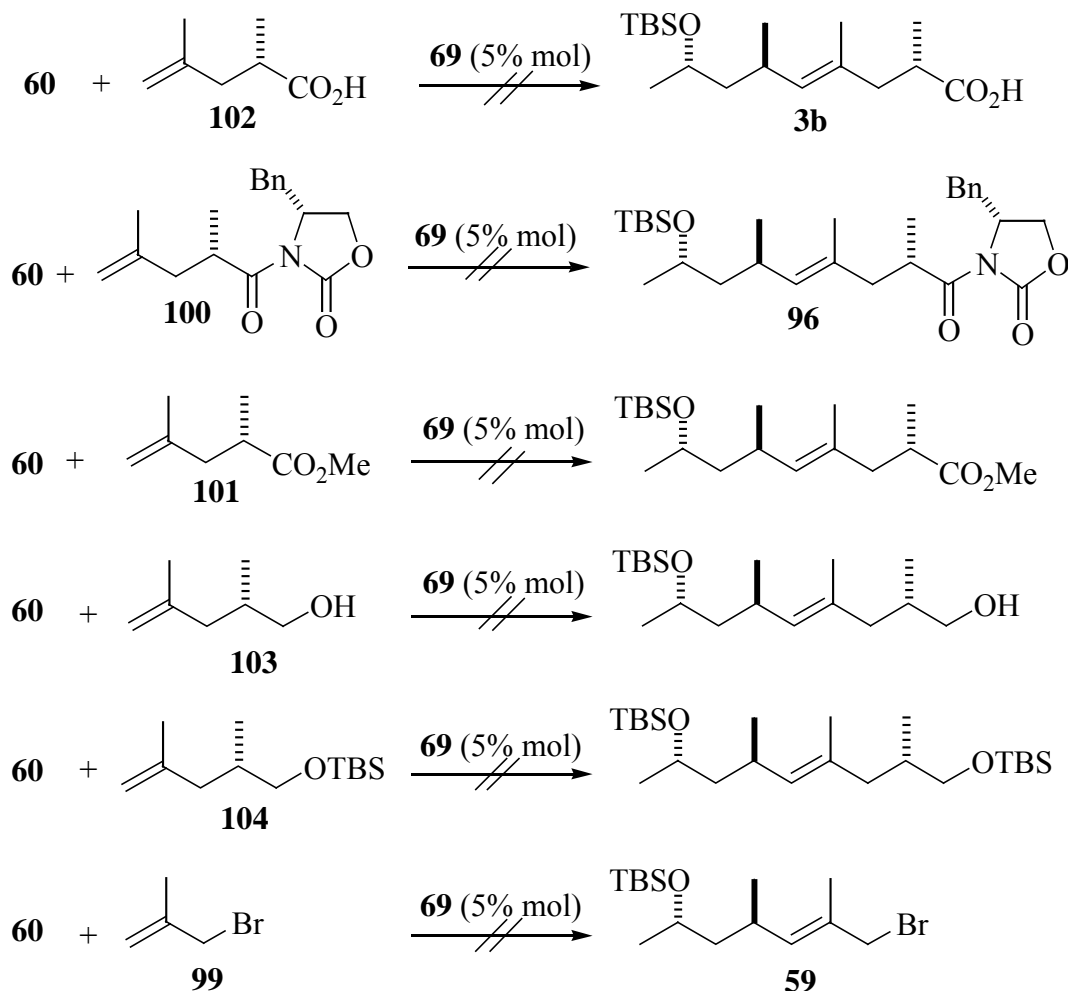

Scheme 3.15: Metathesis of the alkene **60** with various olefins (**99-104**).

Thus, the synthesis via route **A** resulted in over 2 grams of **3b** in 20% yield over 15 reaction steps from the acetoacetate **64**. This approach could possibly allow for the preparation of other analogues of the target molecule.

3.3 Alternative Approach to 8-Hydroxy Acid and Derivatives

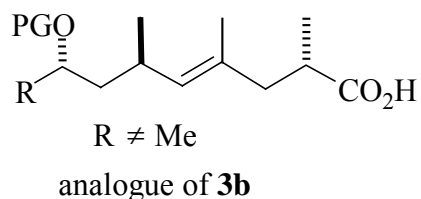

Route **A** could be an excellent methodology for the production of **3b**. However, the scope of biochemical methods using yeast reduction is limited, because of the inherent single-handed, lock-and-key specificity of biocatalysts. For the required chiral configuration at C8, yeast reduction of β -keto ester could furnish only a substituted methyl group.³⁶ (see 3.2.1 Bakers' Yeast Enantioselective Reduction)

Asymmetric catalysis is an integrated chemical approach where the maximum chiral efficiency can be obtained by a combination of suitable molecular design and proper reaction conditions. The use of chiral organometallic molecular catalysts is a powerful strategy for this purpose. They allow for the flexible synthesis of a wide array of enantiopure organic substances from achiral precursors. Figure **3.6** illustrates an ideal way for multiplying molecular chirality.⁷⁷ A small amount of a well-designed chiral catalyst can combine **A** and **B**, producing the chiral **AB** product stereoselectively in a large quantity.

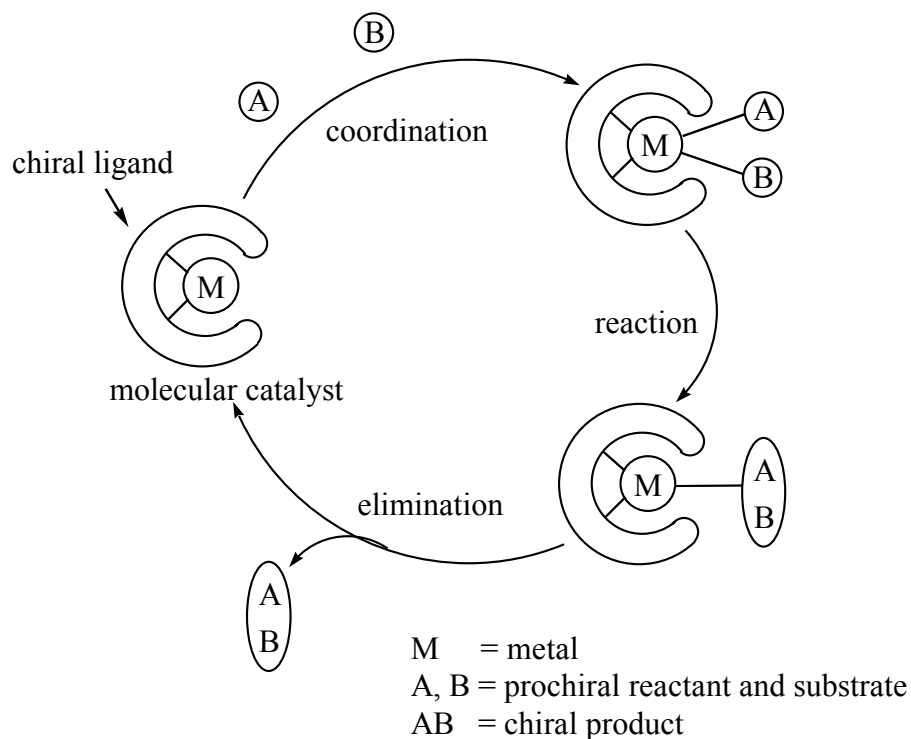

Figure 3.5: A general principle of asymmetric catalysis with chiral organometallic molecular catalysts.

The chiral ligands are enantioselective over a wide range of different reactions. They possess suitable three-dimensional structures and functionality to generate sufficient reactivity and the desired stereoselectivity. One can illustrate that these chiral ligands create effective asymmetric environments for mechanistically unrelated reactions. There are certain classes of synthetic catalysts that modify intrinsically achiral metal atoms. This group of special chiral ligands and catalysts shows high selectivity for example, BINAP and BINOL, bis(disulfonamide) ligands, tartaric acid derivatives, derivatives of the cinchona alkaloids, and chiral salen ligands (Figure 3.6).⁷⁸

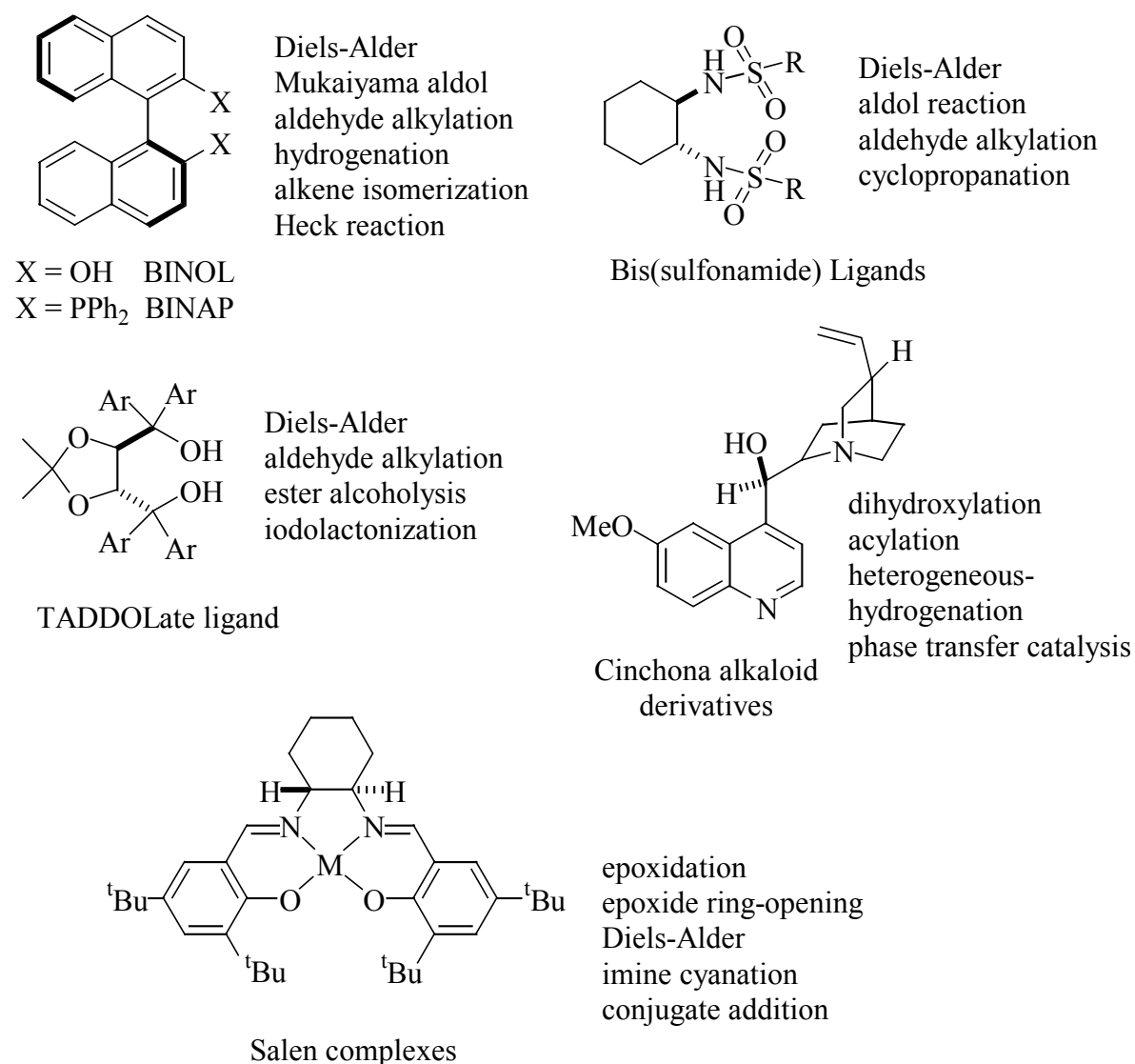
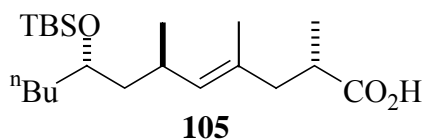
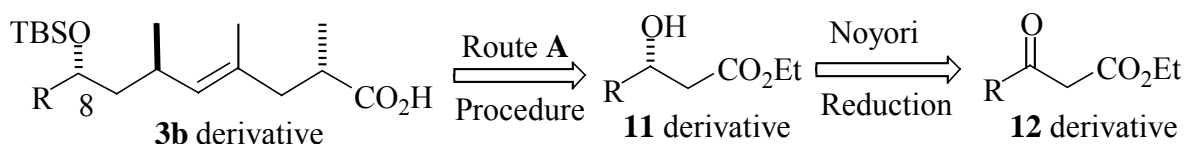

Figure 3.6: Examples of privileged chiral ligands and catalysts.

In this part of the research program, asymmetric processes catalyzed by organometallic complexes were explored in order to allow more flexibility to get the stereoisomeric analogues of the 8-hydroxy acid (**3**). Simpler tactics that mimicked the former approach were designed. The alternative preparation of hydroxy acid **3** and analogues was demonstrated with three different synthesis methodologies as follows:

-ROUTE B

The first plan was based on the Noyori reduction of β -ketoesters **64**. This reaction provides secondary alcohols of type **63** usually in high enantiomeric purity.⁷⁹ The further process could be performed similar to the procedure from route **A**.

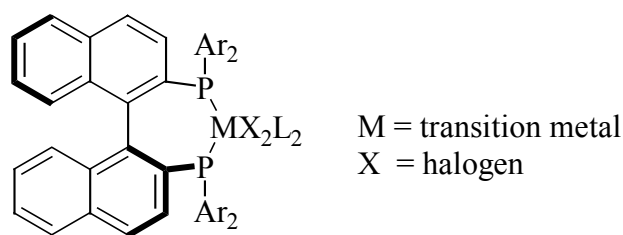

Scheme 3.16: Retrosynthetic analysis for the synthesis of 8-hydroxy nonenoic acid derivatives starting with Noyori reduction of a β -ketoester.

Key Reactions and Mechanisms**3.3.1 Asymmetric Hydrogenation of β -Keto esters**

(*S*)-BINAP-based metal complex

BINAP, 2,2'-Bis(diphenylphosphino)-1,1'-binaphthyl, is a chiral ligand commonly used in the formation of catalytic reagents. This catalyst ligand is a fully aromatic and conformationally flexible atropisomeric C_2 diphosphine. Because rotation about the binaphthyl $CI-CI'$ pivot and $C2-$ or $C2'-P$ bonds is possible without seriously increasing the torsional strain, it can accommodate a range of transition metals, mainly of the second

and third rows, such as Ru(II), Rh(I), palladium and iridium.⁸⁰ The axially dissymmetric C_2 chiral diphosphine exerts strong steric and electronic influences on transition metal complexes. The resulting seven-membered chelate rings containing only sp^2 carbon atoms are in turn skeletal structures.^{80,81} Many of these species promote various asymmetric transformations such as hydrogenation, isomerisation, hydrosilylation, hydroboration and allylic alkylation.

BINAP-Ru dichloride catalysts have a very wide scope for the hydrogenation of β -keto esters.⁸¹ The halide ligand in the Ru complex generates a strong acid HCl and an active species RuHCl, formed by the reaction between Ru complex **A** and H_2 .⁸² These species are important to facilitate the hydride transfer from Ru to the carbonyl carbon (Scheme 3.17).⁸³

The Scheme presents a mechanistic model for (*S*)-(diphosphine)Ru-catalyzed hydrogenation of β -keto esters. First, **B** interacts reversibly with the β -keto ester to form the σ -type chelate complex **C**, in which metal-to-carbonyl hydride transfer is geometrically difficult. Then, protonation occurs at the oxygen to increase the electrophilicity of the carbon and convert the geometry from σ to π , thereby facilitating the hydride migration. The hydroxy ester ligand complex in the resulting product **D** is liberated by solvent molecules. The cationic Ru complex **E** once again cleaves H_2 , thus regenerating **B**. This catalytic cycle takes place repeatedly. Enantioselection of a ratio of >99:1 is achieved in the hydride transfer step **C** to **D**. Here, the key is the carbonyl protonation in **C**, which is caused by HCl ⁸⁴ generated in the induction step **A** to **B**.

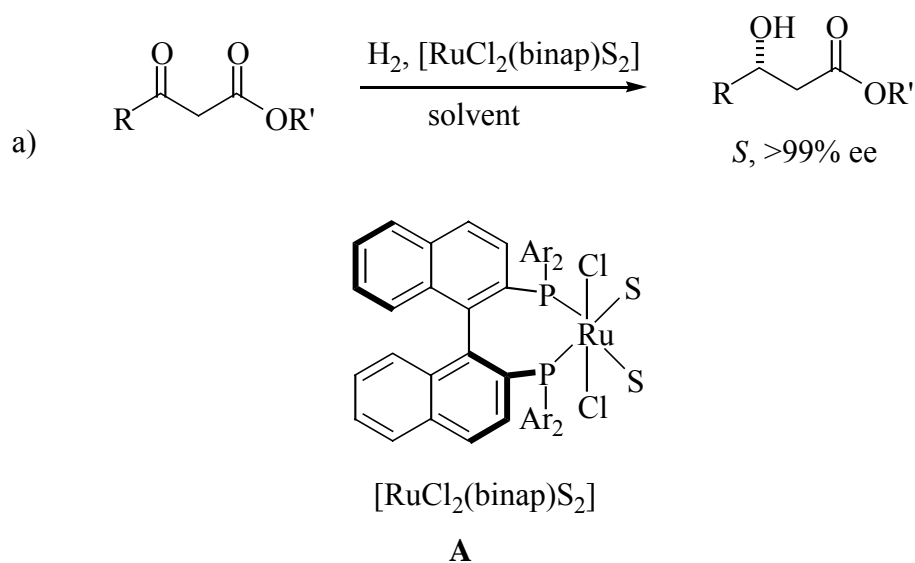

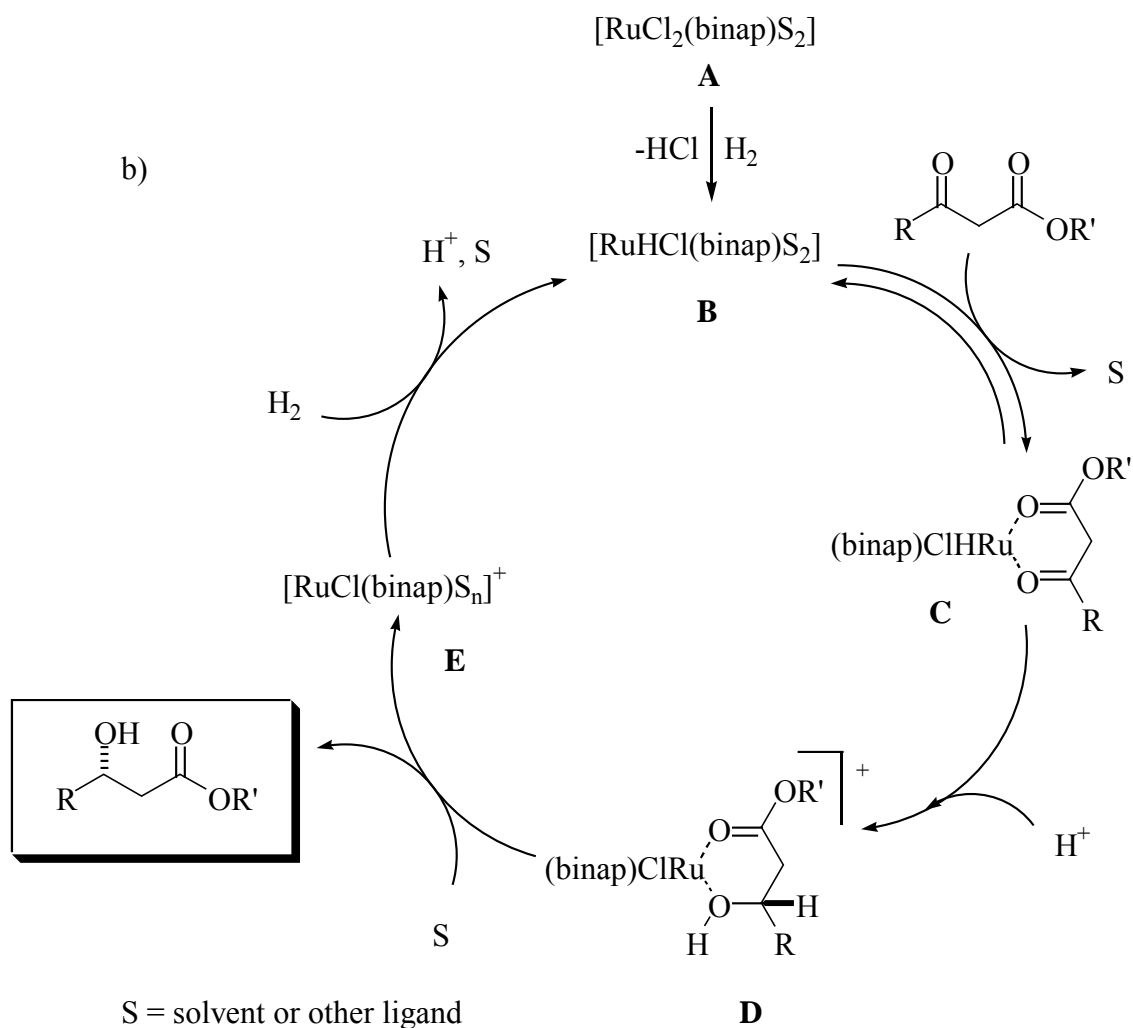

Scheme 3.17: Asymmetric hydrogenation of β -keto esters catalyzed by an (*S*)-BINAP-Ru complex. (a) Reaction scheme. (b) Catalytic cycle.⁸⁵

The chirality of BINAP is transmitted to other metal coordination sites through the chelate structure. The δ or λ geometry is highly skewed and determines the chiral disposition of the P-phenyl rings that play a key role in generating outstanding chirality-discriminating ability at the reactive coordination sites. Ligation of the ester C-O to the Ru center stabilizes the transition states (TSs) in the hydride transfer step. In addition, the oxygen/Ru interaction in transition state is crucial for catalytic activity as well.⁸³

The Figure 3.7 illustrates the chiral environment of an (*S*)-BINAP-Ru complex. The second and fourth quadrants are more crowded than the first and third quadrants because of shielding by the equatorial phenyl groups. The *S*-directing TS is highly favored

over the *R*-generating diastereomer, which suffers from substantial R/P-phenyl repulsive interaction.

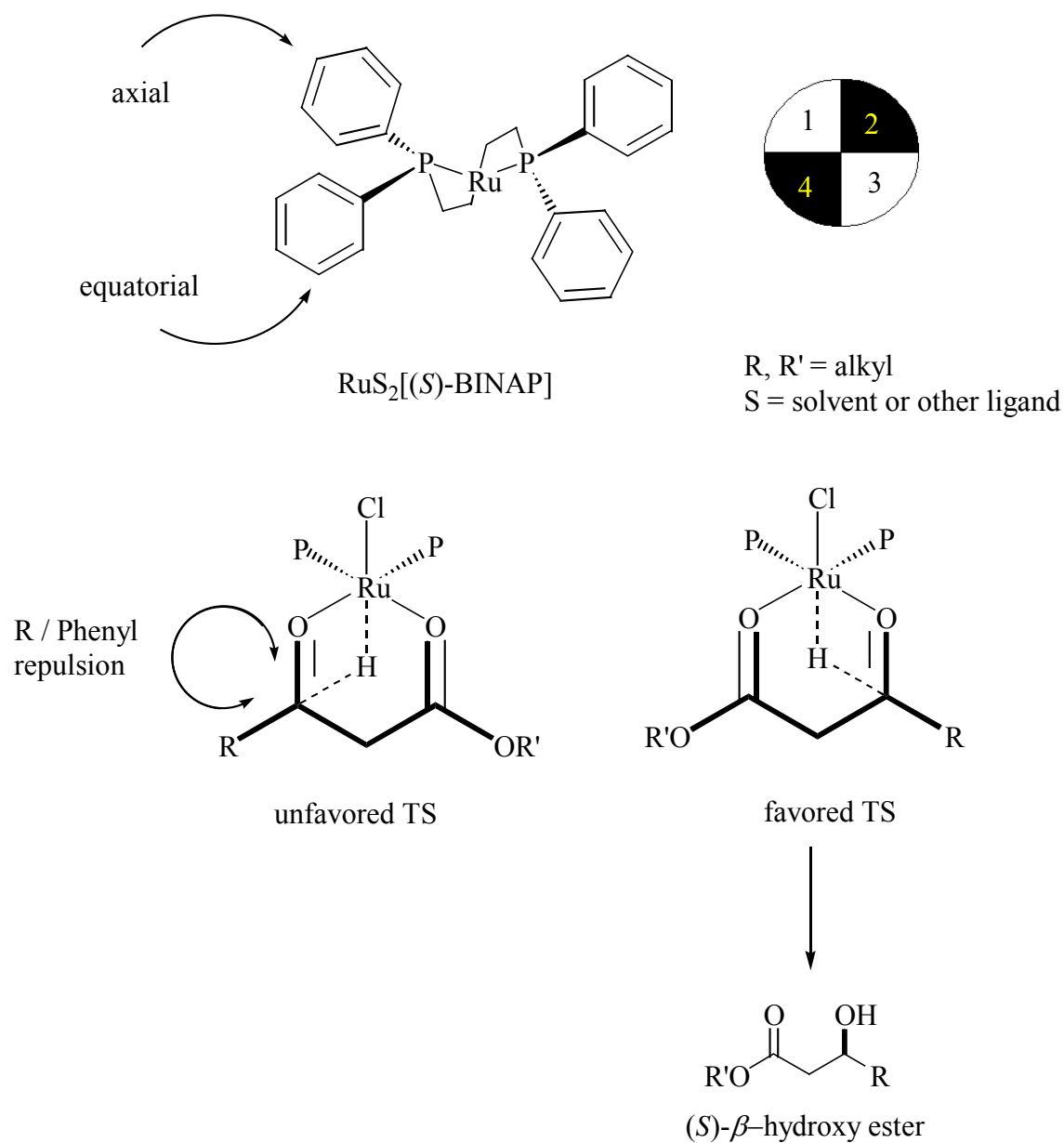

Figure 3.7: Diastereomeric transition states of asymmetric hydrogenation of β -keto esters catalyzed by (S) -BINAP-Ru complexes.^{85,86}

For the hydrogenation of β -keto esters, the presence of the ester moiety is crucial for both high reactivity and enantioselectivity. Because of the assistance of the oxygen-Ru interaction, BINAP can differentiate well between the two stereo-determining diastereomeric TSs.

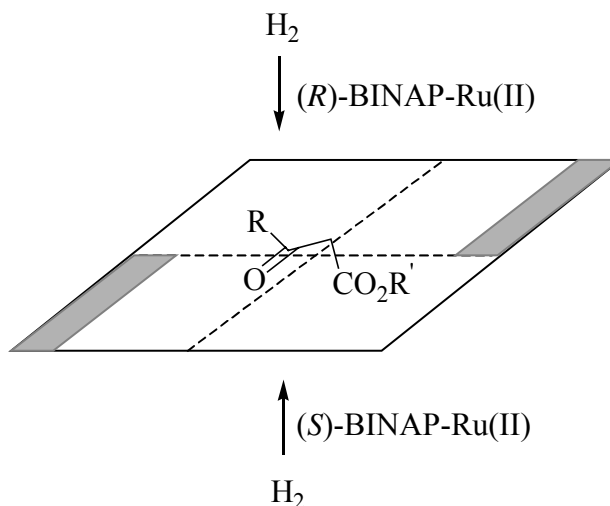
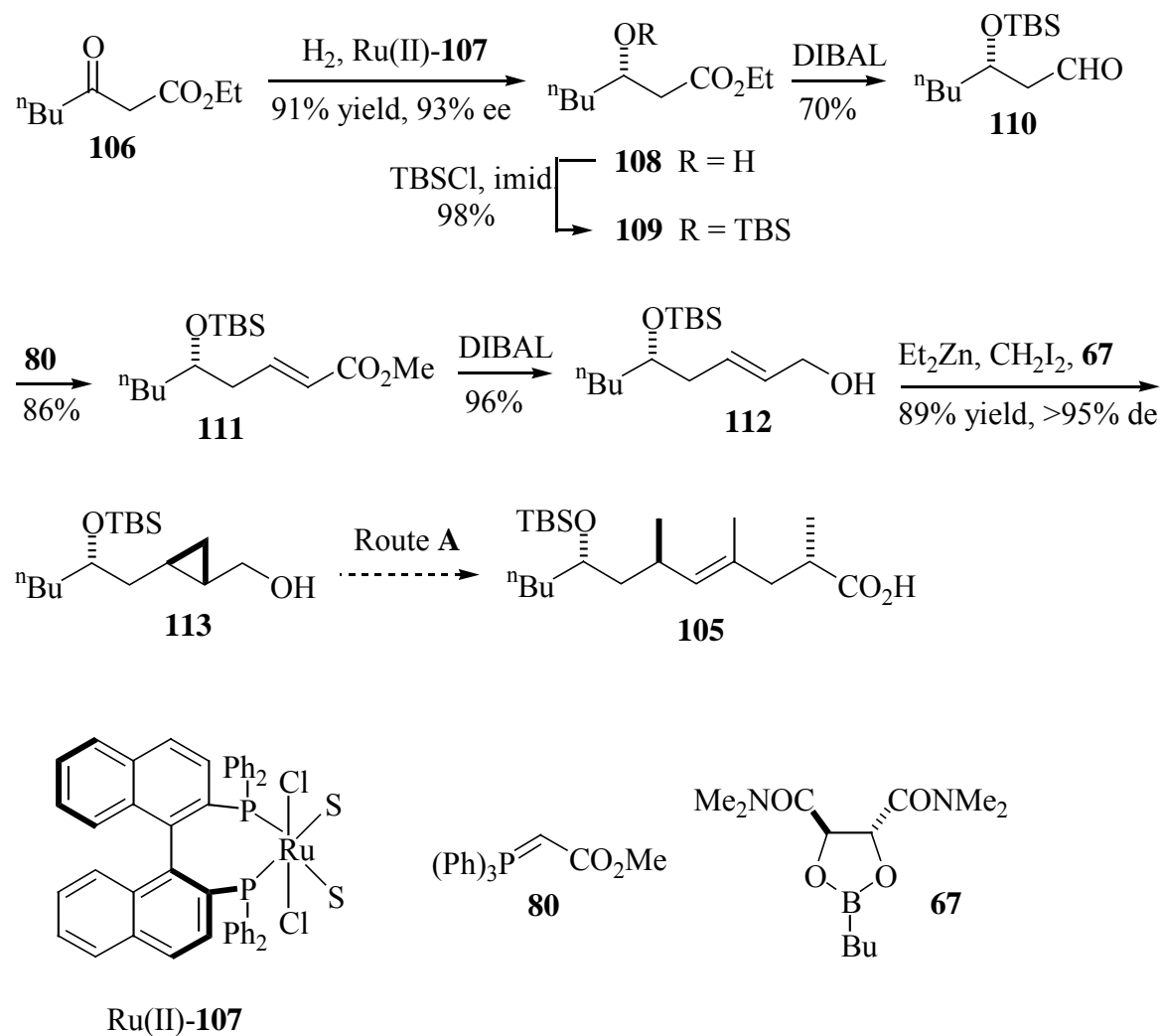

Figure 3.8: Empirical rule for predicting the outcome of the asymmetric reduction in the presence of BINAP-Ru complexes.⁸⁷

Synthetic Pathway

Ethyl 3-oxoheptanoate (**106**), available by the general procedure for the preparation of γ -substituted β -ketoesters, either from carbethoxylation⁸⁸ of 2-hexanone with diethylcarbonate in the presence of sodium hydride or by aldol-type condensation⁸⁹ of pentanal with ethyl diazoacetate, was selected as the starting material for this strategy. Noyori hydrogenation with chiral ruthenium compound (Ru-**107**) converted compound **106**^{79,88a} to a chiral alcohol **108** in 91% yield, 93% ee as determined by GC (see 3.3.1 Asymmetric Hydrogenation of β -Keto ester). Compound **113** was made according to those from the synthetic pathway to the 8-hydroxy acid **3b**. The subsequent silylation of the hydroxyl group with *tert*-butyl-dimethylsilyl chloride (TBSCl) in the presence of imidazole gave silyl ether **109**.⁹⁰ Reduction⁹¹ with diisobutylaluminum hydride (DIBAL-H) yielded the aldehyde **110** that was converted to the enoate **111** by reaction with the stabilized Wittig reagent $(\text{Ph})_3\text{P}=\text{CHCO}_2\text{Me}$ (**80**).⁹² Reaction of the enoate with 2.2 equivalents of DIBAL-H furnished the allylic alcohol **112**.⁹³ The allylic alcohol was converted to the

hydroxymethylcyclopropane **113** using the combination of diiodomethane, diethylzinc and the chiral dioxaborolane **67** (Charette method).⁴² Ethyl 3-oxoheptanoate (**106**)⁹⁴ was easily converted to hydroxymethylcyclopropane **113** in 57% yield over 6 steps. According to the ¹H NMR spectrum, this compound was diastereomerically pure (>95%). The sequence leading to the required building block **113** is shown in Scheme 3.18.



S = solvent or other ligand

Scheme 3.18: Synthesis of the key building block **113** as an analogue of **61**.

However, this analogue was not our main target. Nevertheless, it could be shown that the general sequence works for aliphatic ketoesters. Further routine steps could convert the cyclopropyl alcohol **113** to the acid **105**.

A published sequence of reactions was followed to synthesize (*S*)-2,2'-bis(diphenylphosphino)-1,1'-binaphthyl (*S*-BINAP, **107**) as a chiral catalyst for hydrogenation as shown in Scheme **3.19**.⁹⁵ The resolution of (\pm) 1,1'-bi-2-naphthol (**115**), prepared in one step from β -naphthol (**114**),^{95c} with *N*-benzylcinchonidinium chloride (**116**)⁹⁶ in acetonitrile, gave (*R*)- and (*S*)-binaphthols⁹⁷ in 44% yield, >99% ee and 49% yield >98% ee, respectively.^{95b} (*S*)-Binaphthol was converted with triflic anhydride and pyridine to the ditriflate **117**. This was then subjected to a Ni-catalyzed cross-coupling reaction with four equivalents of diphenylphosphine (Ph₂PH)⁹⁸, 1,4-diazabicyclo[2.2.2]octane (DABCO) and a catalytic amount of 1,2-bis(diphenylphosphino)ethane[nickel(II) chloride (NiCl₂dpps) (10%) in DMF at 100 °C, over 2 days, to provide the (*S*)-BINAP (**107**) in 60% yield.^{95a} Using (*R*)-binaphthol instead, the same sequence and conditions afforded (*R*)-BINAP.

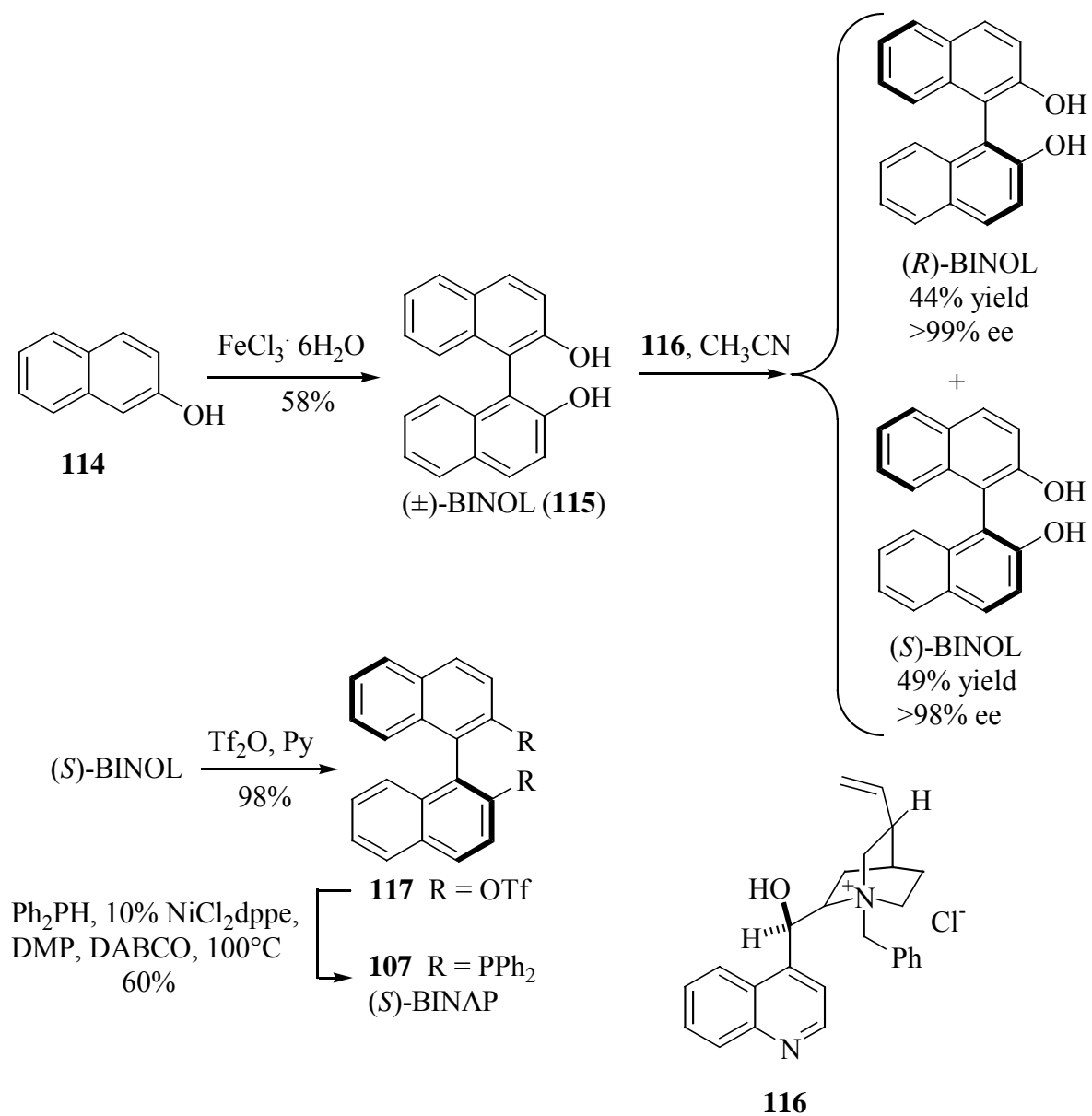

Scheme 3.19: Synthesis of chiral ligand **107**.

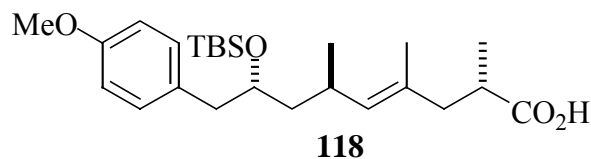
-ROUTE C

The analog **118** was designed in order to probe the size at the terminus as well as to see whether hydrophobic effects can influence the activity of jasplakinolide analogues. In order to connect the aryl ring to the carbon chain we thought of reacting an arylmetal nucleophile with an epoxide. Hydrolytic kinetic resolution (HKR) catalyzed by chiral (salen)Co complexes, derived from chiral ligands **119** with cobalt(II)acetate tetrahydrate (Co(II)(OAc)₂·4 H₂O),⁹⁹ has appeared to be a powerful method for the preparation of enantiomeric pure terminal epoxides.^{99a} (Scheme 3.20) The attractive features of the HKR include high selectivity factors across a wide range of terminal epoxides. It allows access to highly enantioenriched (>99% ee) products close to theoretical yields.¹⁰⁰ The reaction protocol also involves a commercially available catalyst, which allows the resolution at low costs.¹⁰¹

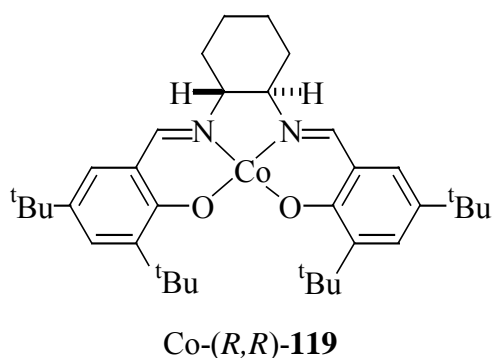
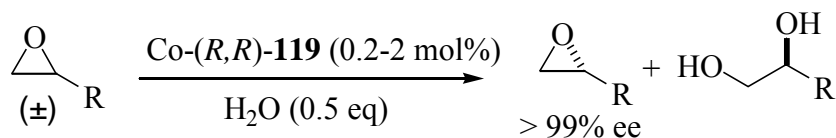

Scheme 3.20: The hydrolytic kinetic resolution catalyzed by chiral (salen)Co complexes.^{99a}

Introduction of the *C*8 stereocenter by the HKR technique followed by opening of the epoxide with the dithiane anion and subsequent hydrolysis of dithiane **120** would yield the aldehyde **63**. The remaining sequence leading to target molecule **118** could proceed as described before.

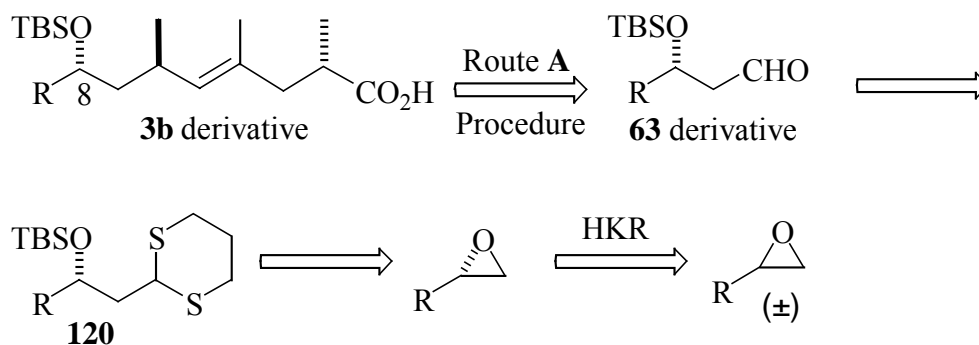

Scheme 3.21: Retrosynthetic analysis for the synthesis of 8-hydroxy nonenoic acid derivatives starting with hydrolytic kinetic resolution technique.

Key Reactions and Mechanisms

3.3.2 Hydrolytic Kinetic Resolution

The mechanism of the hydrolytic kinetic resolution (HKR) can be compared with other asymmetric ring-opening reactions using (salen)-metal complexes. The active catalyst is the (salen)Co-OH which serves both as a nucleophilic and Lewis acidic component. Kinetic studies showed that the reaction is second order with regard to the salen-complex (Scheme 3.22).

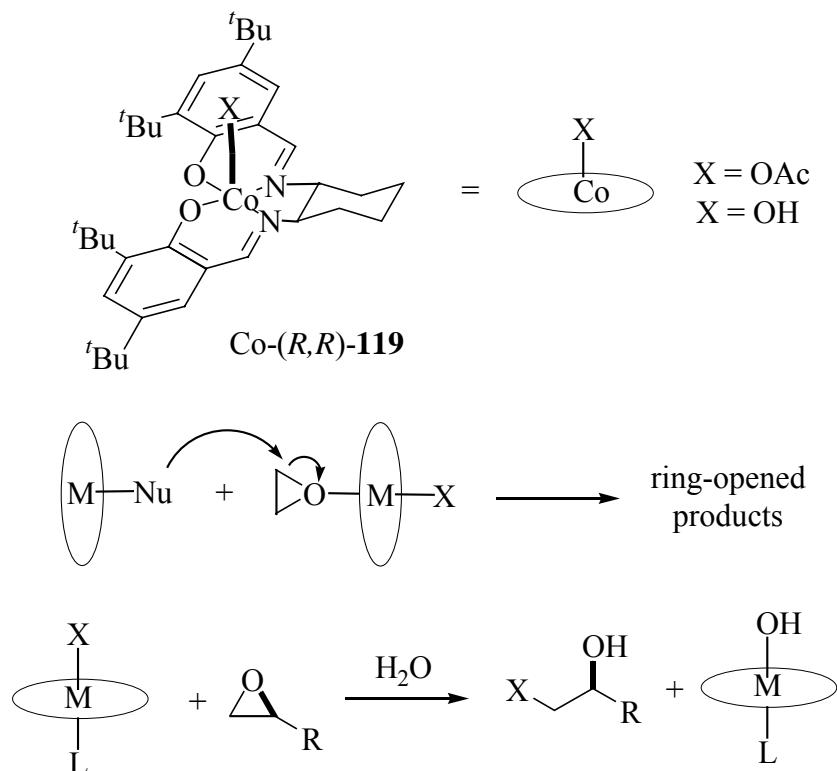

Scheme 3.22: The mechanism for hydrolytic kinetic resolution (HKR), considered as a asymmetric ring-opening reaction.¹⁰²

Both epoxide enantiomers bind to the Co-OH complex with similar affinity. Thus the high selectivity in the HKR results not from selective binding to the chiral catalyst, but from the selective reaction of one of the epoxide complexes.

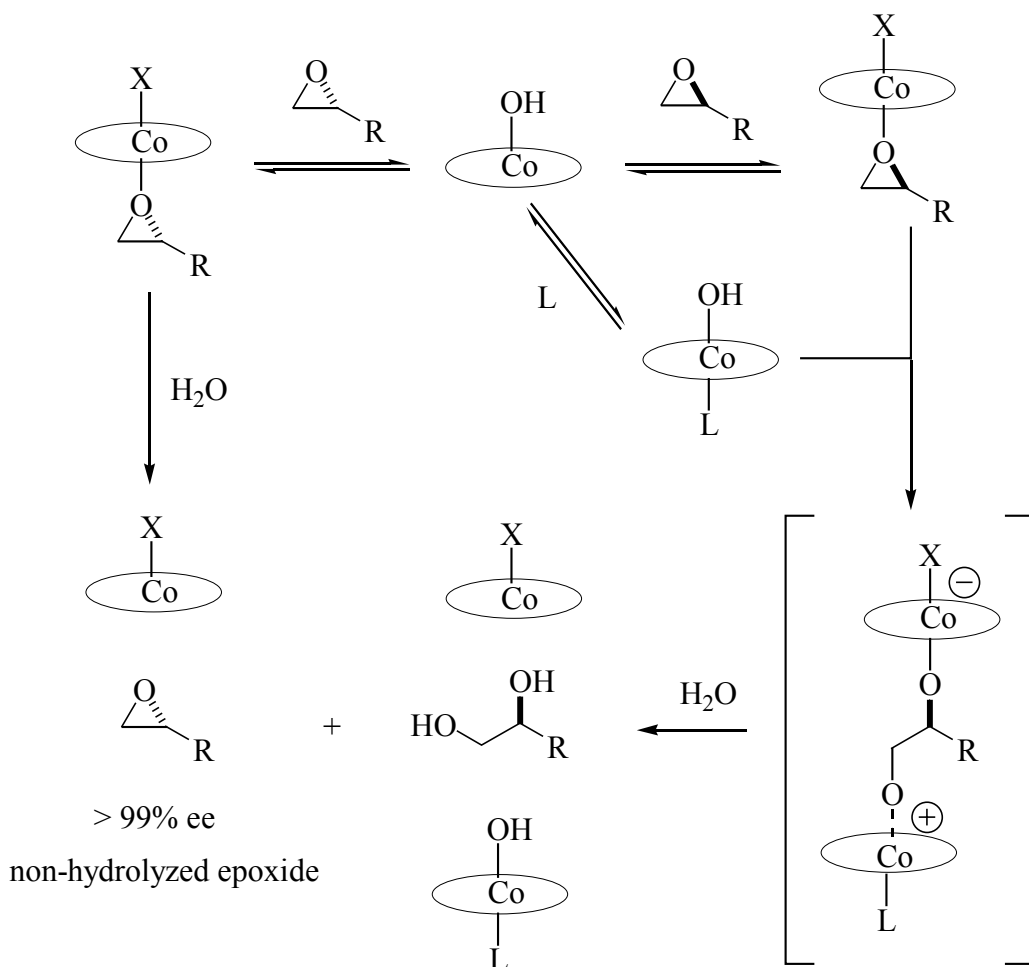

Scheme 3.23: A cooperative bimetallic mechanism for hydrolytic kinetic resolution (HKR).¹⁰²

Synthetic Pathway

We examined the utility of complex Co-**119** in HKR under standard conditions.^{99a} In this case, the aromatic (*p*-methoxy benzyl group) side chain on C8 was selected. Starting from (\pm)-**121**, two possible routes, which differed in the sequence of kinetic resolution and introduction of the aromatic side chain, were explored. The first approach to epoxide (*S*)-**123**¹⁰³ was kinetic resolution of epichlorohydrin¹⁰⁴ ((\pm)-**121**) and subsequent introduction of the aromatic side chain by nucleophilic substitution with lithium 4-methoxyphenyl (**122**). The first approach gave highly enantioenriched (>99% ee) products as determined by GC. In the second route racemic epoxide was first prepared from epichlorohydrin followed by HKR. While the chemical yield in the hydrolysis step was satisfactory, the

enantiomeric purity of the non-hydrolyzed **123** was rather low. The ee-value for the epoxide was only 19% as measured by GC. The result suggested that the aryl side chain of **123** might cause conflicting steric and electronic effects influencing the regioselectivity in the epoxide ring opening.⁹⁹ This could induce low selectivity factors. It was therefore gratifying to obtain (*S*)-**123** derived from (\pm)-epichlorohydrin ((\pm)-**121**) by introduction of the aromatic side chain after the HKR.

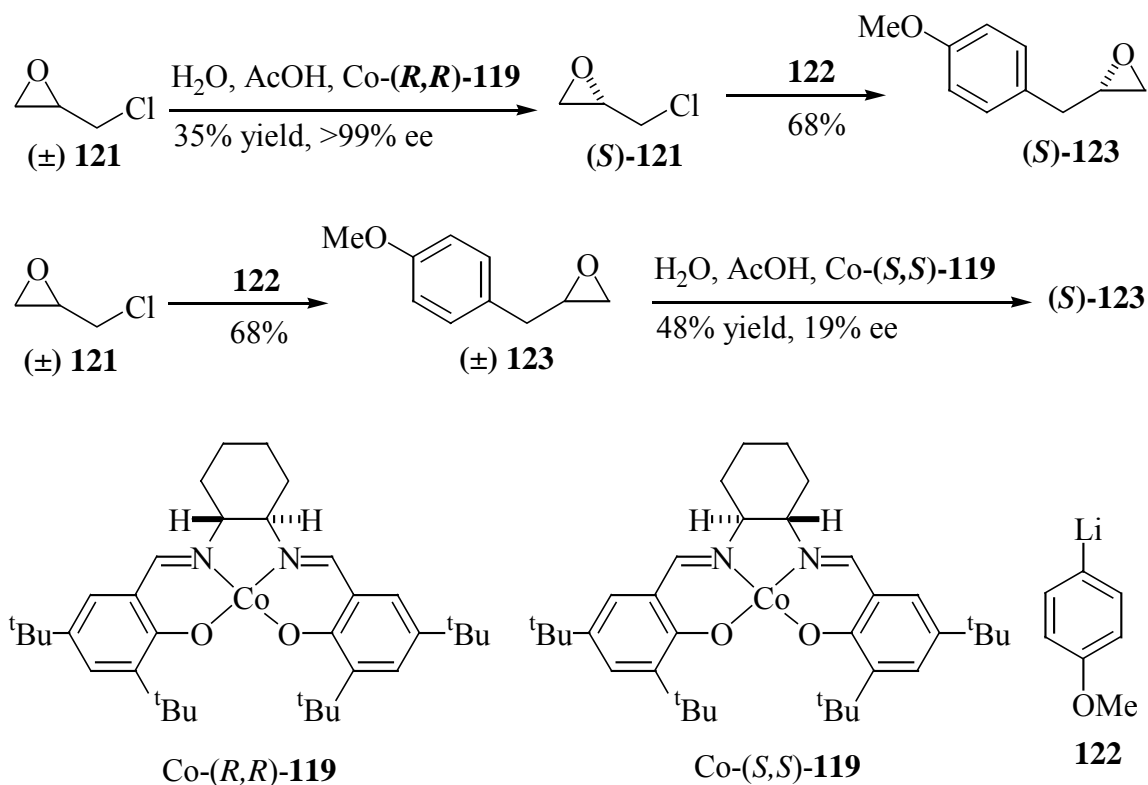

Scheme 3.24: Two possibilities for the synthesis of epoxide (*S*)-**123** using HKR.

The next step was treatment of 2-*tert*-(butyldimethylsilyl)-1,3-dithiane¹⁰⁵ (**124**) with *t*-BuLi, followed by addition of the terminal epoxide (*S*)-**123** to generate the intermediate alkoxy dithiane **125**. Brook rearrangement was triggered by addition of HMPA. After quenching of the reaction with NH₄Cl the silyl ether **126** was obtained in 75% yield.¹⁰⁶ Dithiane **126** was converted to aldehyde¹⁰⁷ **127** by treatment with methyl iodide-calcium carbonate in aqueous acetonitrile.¹⁰⁸ Since aldehyde **127** was considered as an analogue of aldehyde **79**, the remaining steps to the desired acid were subsequently patterned according to those of route **A**. Thus, compound **127** was converted to the enoate⁶³ **128** by reaction with the stabilized Wittig reagent (Ph)₃P=CHCO₂Me (**80**). Reaction of the enoate **128** with 2.2 equivalents of DIBAL-H furnished the allylic alcohol **129**⁶⁵ which was converted to the

hydroxymethylcyclopropane **130** using a combination of diiodomethane, diethylzinc and the chiral dioxaborolane **67** (Charette method).⁴² The sequence leading to the required hydroxymethylcyclopropane **130** is shown in Scheme 3.25.

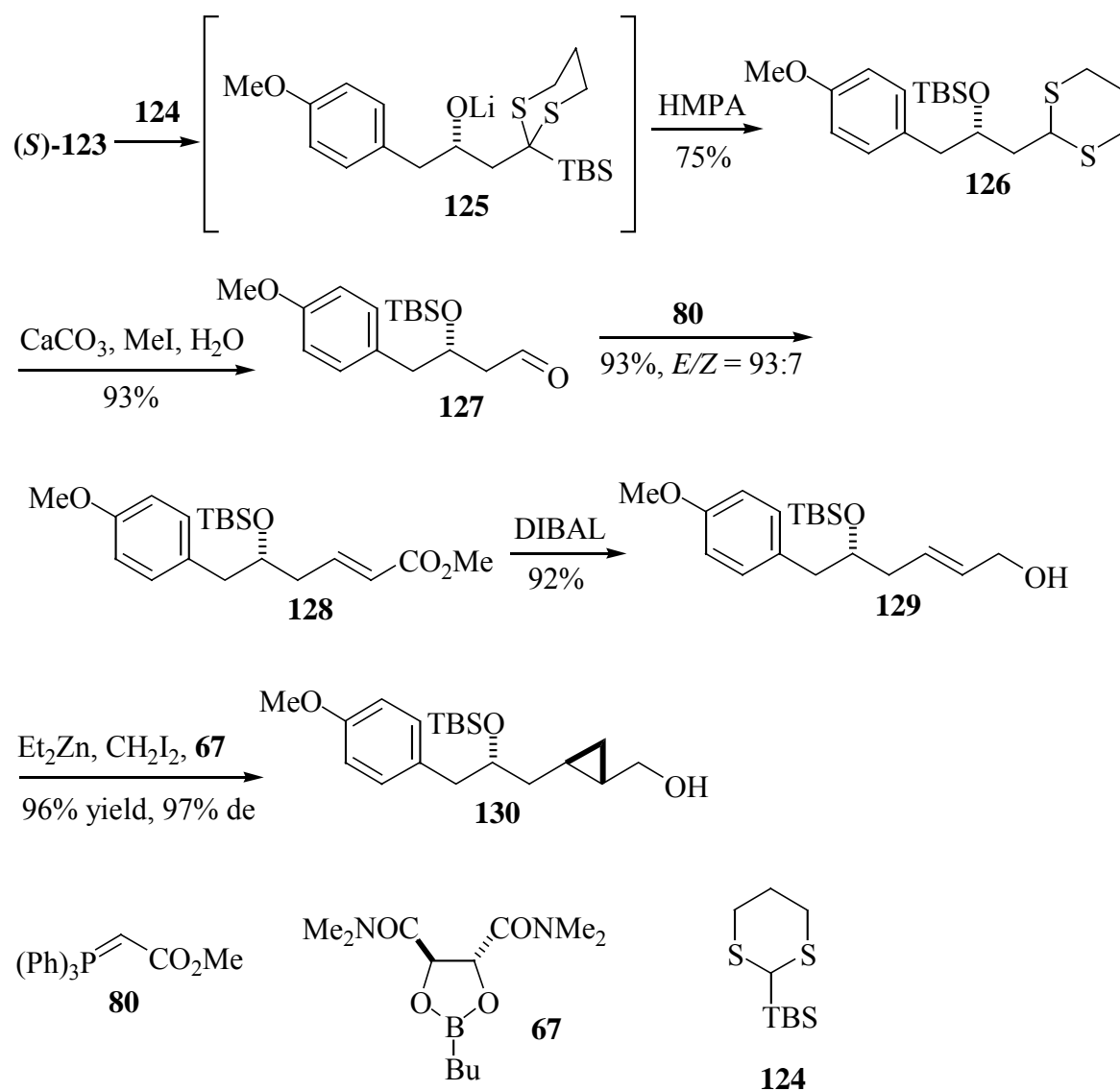

Scheme 3.25: Synthesis of the hydroxymethylcyclopropane **130**.

For the conversion of the primary alcohol **130** to the corresponding iodide **133** we initially followed the pathway via the mesylate **132**. However treatment of the alcohol **130** with mesyl chloride and triethylamine provided only the mesyl alcohol **131** with the silyl ether being cleaved. Therefore iodide **133** was obtained by treatment of alcohol **130** with triphenyl phosphite and methyl iodide.⁶⁶ After a couple of trials, iodide **133** was obtained

in fair yield.¹⁰⁹ The reductive ring opening⁶⁷ of the cyclopropane ring with *n*-butyllithium in THF between -78 and -30 °C provided the alkene **134** in 50% isolated yield. According to the ¹³C NMR spectrum, this compound is diastereomerically pure (>97%).

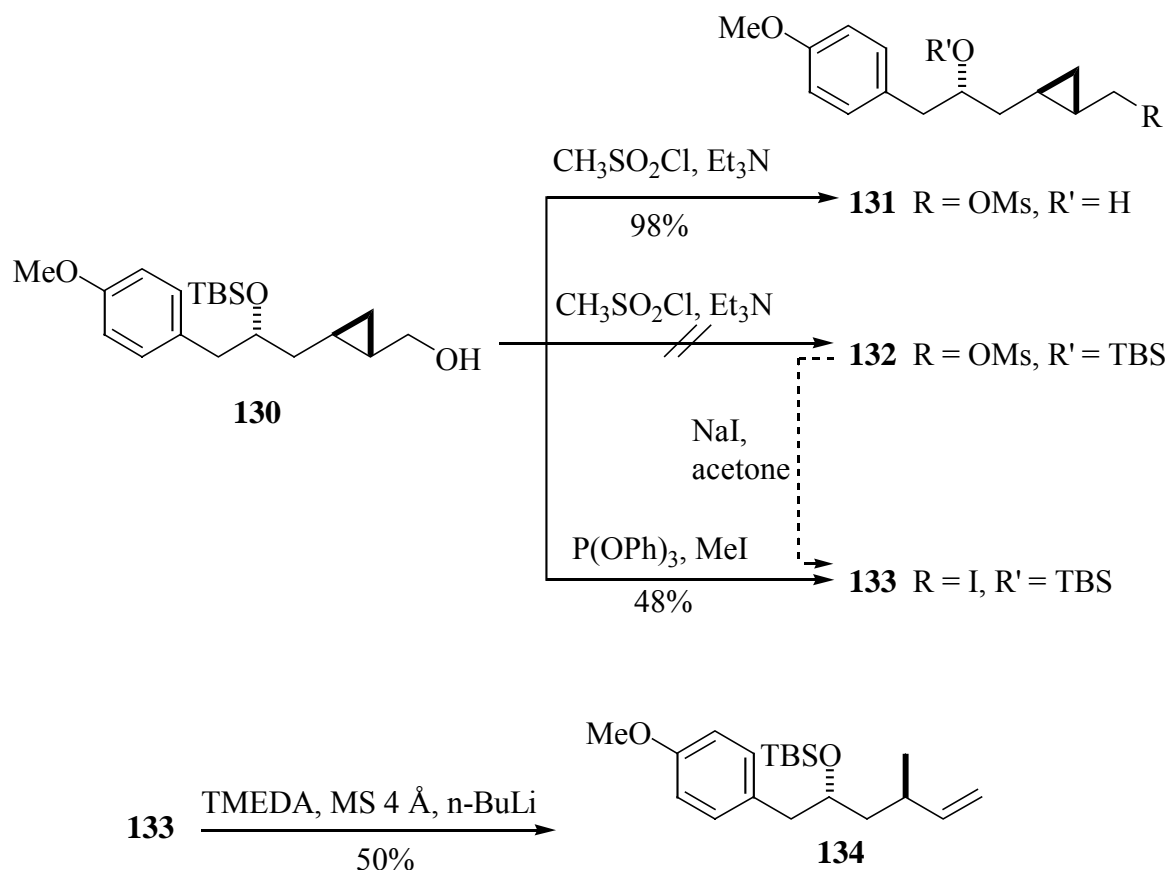

Scheme 3.26: Synthesis of to the key building block **134**.

If one compares the above result with those from the natural product (route **A**) it can be seen as moderately efficient. Even more surprising results were observed from the cross coupling metathesis¹¹⁰ of the terminal alkene **134** with methyl methacrylate (**92**) because only black oil was obtained. It was not possible to purify the resulting product. To circumvent the problem, other alternatives to reach enoate **135** were examined. Unfortunately, all attempts at the synthesis of the aldehyde **136** or the diol **137** by oxidizing the double bond with ozone,⁷⁰ AD mix¹¹¹ or potassium osmate dihydrate ($\text{K}_2\text{OsO}_4 \cdot 2\text{H}_2\text{O}$)¹¹² also failed.

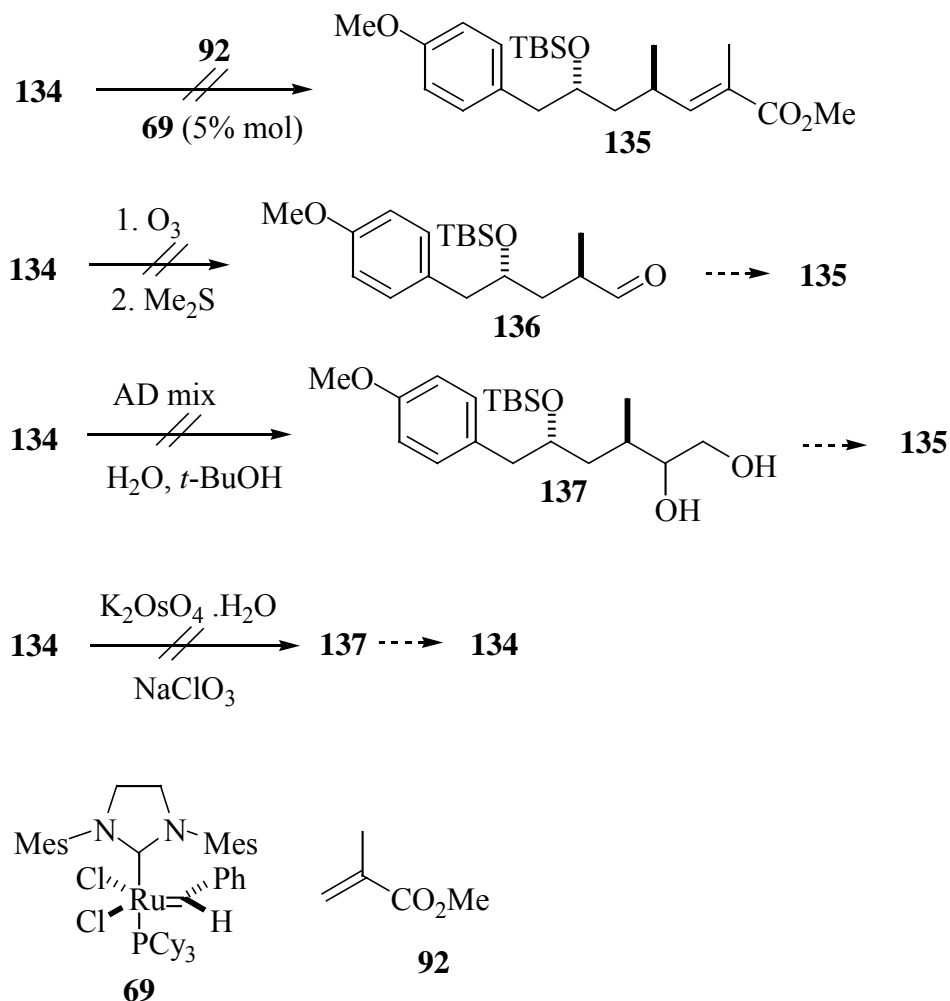

Scheme 3.27: Attempts for the synthesis of the enoate **135**.

We thought that unwanted cleavage of the TBS-group during the metathesis and oxidation reactions was to blame for the failure. Therefore the TBS-group was replaced by the TBDPS-group. The desired allyl compound **139** with a new protecting group was then prepared accordingly. After removal of the TBS-protecting group with TBAF to give free secondary alcohol **138**,^{65a} the compound **139** was obtained by subsequent silylation of the free hydroxy group of **138** with *t*-butyl-diphenylsilyl chloride (TBDPSCl) in the presence of imidazole.⁹⁰ The prepared alkene **139** was then coupled with methyl-2-methylacrylate (**92**) by the general procedure¹¹⁰ with various conditions for the cross coupling metathesis. Unfortunately, the result was disappointing again. No desired product was observed. The next attempt was the oxidation of the double bond either with ozone⁷⁰ or potassium osmate

dihydrate ($\text{K}_2\text{OsO}_4 \cdot 2\text{H}_2\text{O}$)¹¹² to the aldehyde **141** and the diol **142**. These attempts were also unsuccessful. The attempts to prepare enoate **140** are shown in Scheme 3.28.

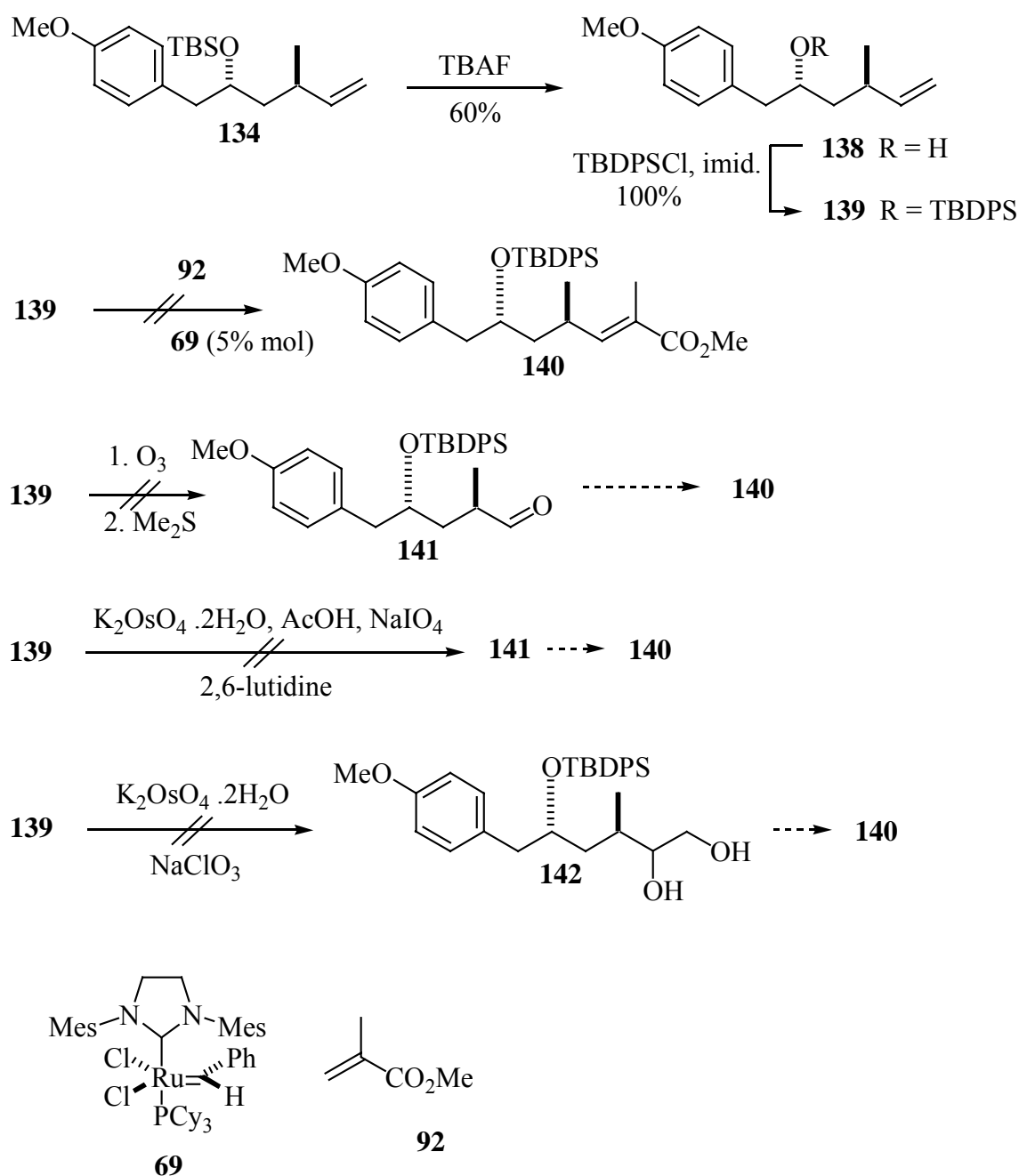

Scheme 3.28: Attempts of the synthesis of the enoate **140**.

It seems that the presence of the electron rich aromatic ring is the reason for the failure of the alkene **60** modification. In order to obtain compound **118** other strategies would be required that do not take the path through alkene **134**. However, at this point we concentrated our effort on developing another route to the natural nonenoic acid **3b**.

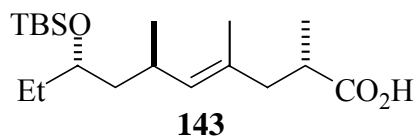
-ROUTE D

Enantioselective catalytic transformations that involve C-C bond formation are rather rare as compared to functionalizing conversions of a given carbon skeleton.¹¹³ Among the best studied reactions of these types are nucleophilic additions to carbonyl compounds catalyzed by modified Lewis acids as electron-withdrawing chiral ligands.^{113a, 114} This is especially true for the reaction of diethyl zinc with aldehydes.^{113a,115}

We planned to use this reaction for the introduction of the chiral center at C8. The aldehyde substrate was chosen in such a way to allow creation of the stereocenter at C6 by a diastereoselective methylation on a lactone template. From lactone **34** the strategy of White could be used.²⁶ Consequently, the key element in this synthesis is the preparation of analogues of **32**.¹¹⁶

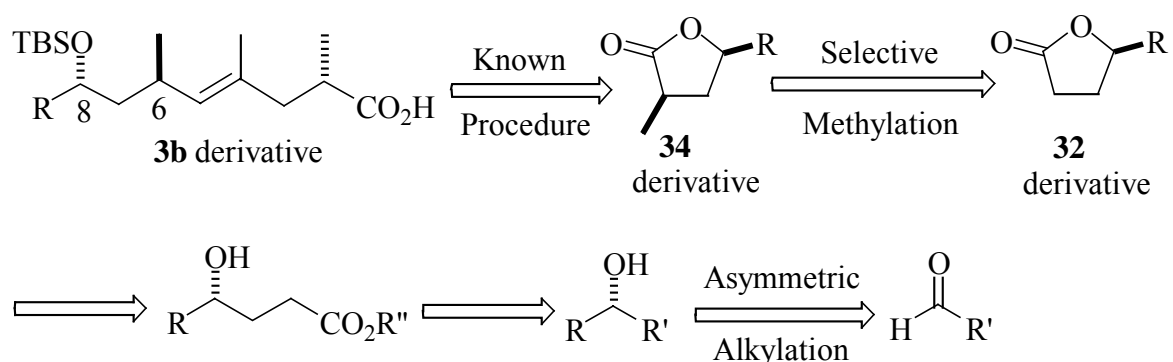

Scheme 3.29: Retrosynthetic analysis for the synthesis of 8-hydroxy nonenoic acid derivatives by starting with a symmetric alkylation of an aldehyde.

Key Reactions and Mechanisms

The catalytic asymmetric addition of alkyl groups to aldehydes is an important reaction for the enantioselective synthesis of secondary alcohols. The addition of organometallic reagents to carbonyl groups has proven to be the one of the most successful reactions in this regard. For instance the addition of dialkylzinc reagents to aldehydes in the presence of chiral Lewis acid catalysts can result in excellent enantioselectivities.¹¹⁵ Among some successful catalysts in these reactions are titanium complexes which employ chiral amino alcohol,¹¹⁷ diol¹¹⁸ or bis(sulfonamide)¹¹⁹ based ligand systems (Scheme 3.30).

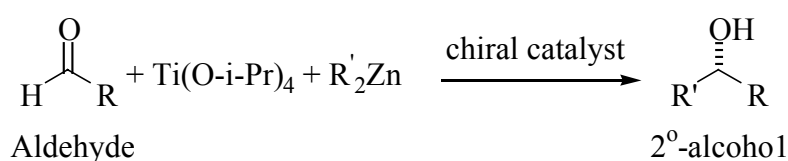

Scheme 3.30: Alkylation of aldehydes in the presence of chiral Lewis acid catalysts.

Although a wide variety of dialkylzinc reagents and aldehydes have been employed, the mechanism of this process has not been adequately explored. Two possible transition states to explain the asymmetric addition reaction have been proposed (Figure 3.9).^{117a}

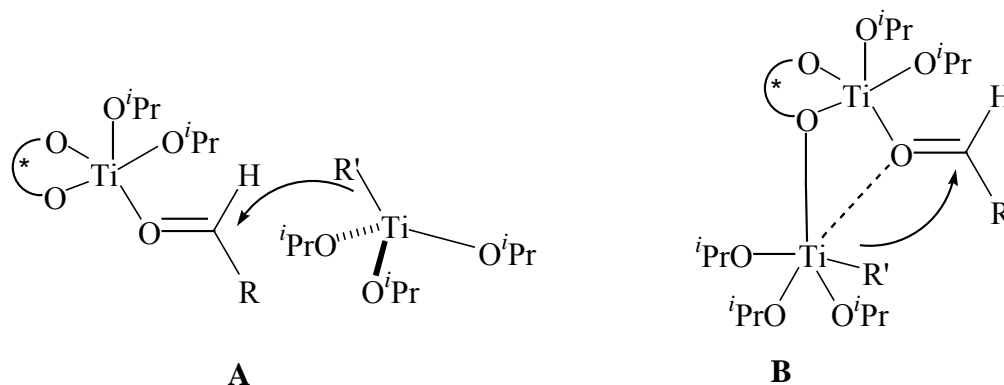
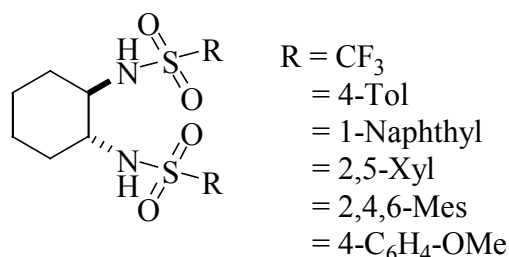

Figure 3.9: Possible transition states for the asymmetric addition reaction.

3.3.3 Asymmetric Alkylation catalyzed by Bis(sulfonamide) Ligands



Bis(sulfonamide) ligands form efficient and highly enantioselective catalysts for a number of reactions.^{119b} These ligands are highly effective in the asymmetric amination of *N*-acyloxazolidinones with magnesium catalysts,¹²⁰ asymmetric cyclopropanation of allylic alcohols with zinc catalysts,¹²¹ and the asymmetric Diels-Alder reaction with aluminum Lewis acids.¹²² The Lewis acidic magnesium bis-(sulfonamido) complex can potentially coordinate the sulfonyl oxygens, and evidence exists for this interaction in related systems.¹²³ Bis(sulfonamide) ligands gave poor enantioselectivities when used with dialkylzinc reagents alone. However when titanium tetraisopropoxide was added, the resulting catalysts proved to be highly enantioselective.¹¹⁹ The further scope of this process was delineated by employing a variety of aldehydes and functionalized dialkylzinc reagents to provide elaborate secondary alcohols with excellent enantioselectivity.^{119,124}

It is conceivable that the bis(sulfonamide) reacts first with R₂Zn and then is transmetalated to titanium.¹²⁵ It is also possible that an equilibrium between the titanium complex and the bis(sulfonamide) species as shown in Scheme 3.31 exists.¹²⁶ The equilibrium is driven to the right by reaction of the dialkylzinc reagent with liberated 2-propanol.

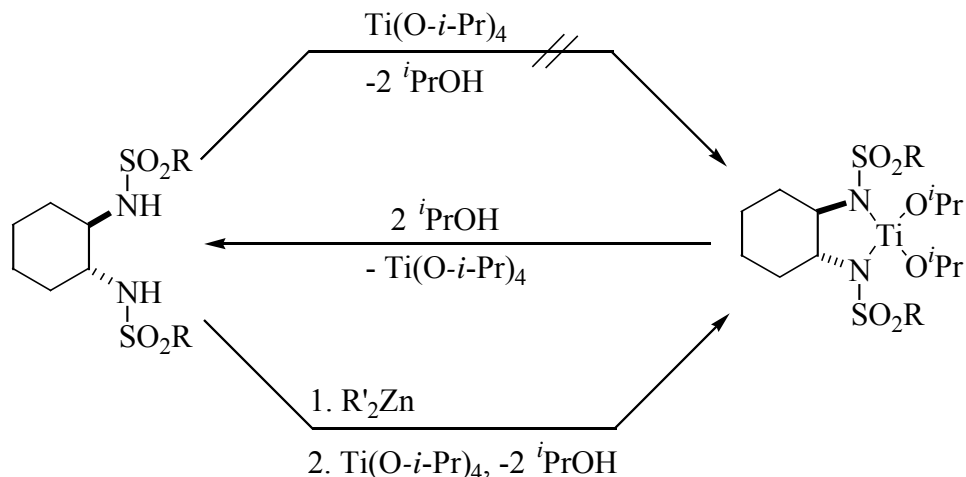

Scheme 3.31: The possible equilibrium between disulfonamide and titanium complex.^{117a}

It could be possible that the oxygen atoms of the sulfonamide group are involved in the complexation of the titanium. This would require a C_2 -symmetric conformation as indicated in Figure 3.10.^{117a,119,124g,127} However, it is not clear whether the titanium complex is a monomer^{119b,124g} or dimer¹²⁸.

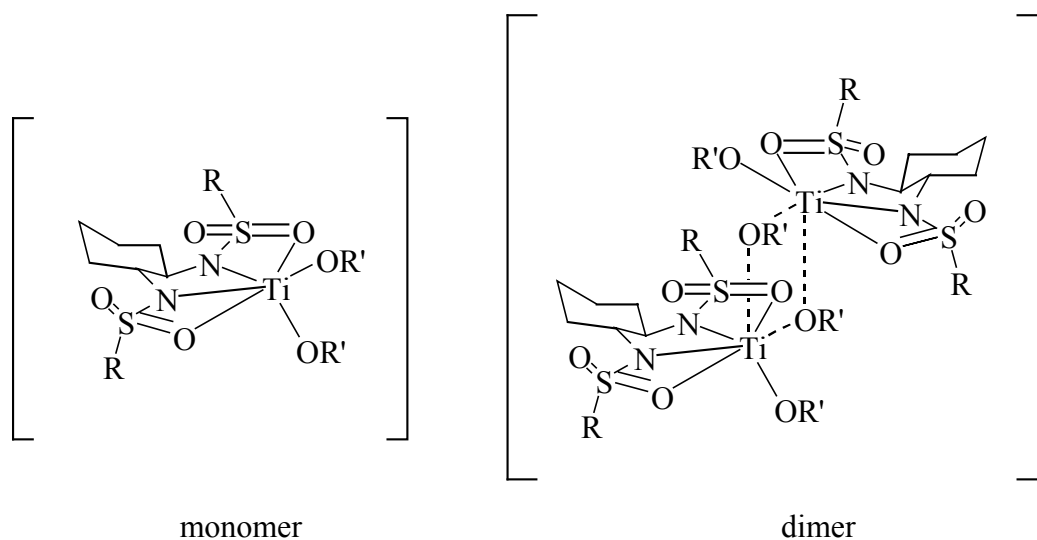
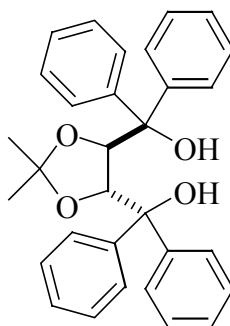

Figure 3.10: Proposed transition state for exchange of chiral alkoxides.^{117a}

3.3.4 Asymmetric Alkylation catalyzed by TADDOLates



TADDOL

TADDOL contains two adjacent diarylhydroxymethyl groups in a trans relationship on a 1,3-dioxolane ring. The TADDOL family of ligands has a large number of analogues with different aromatic substituents and acetal moieties.¹²⁹ They can be prepared from acetals or ketals of tartrate esters by reaction of the latter with aromatic Grignard reagents. TADDOL ligands have been used very successfully in many areas of asymmetric synthesis as extraordinarily versatile chiral ligands for some metals such as titanium or aluminium.^{129,130}

The free rotation of the diphenylmethanol moiety of the unbound ligand is constrained upon metallacycle formation to give a trans-fused bicyclo[5.3.0]decane ring system.^{129,131} This interaction can limit the degrees of rotational freedom within the metal-ligand framework. The stereocenters of the dioxolane are too far removed from the metal center to have a stereodiscriminating effect. Nonetheless they exert a powerful conformational preference on the adjacent metallacycle, effectively directing the diastereomeric aromatic substituents to adopt pseudoequatorial and pseudoaxial positions. As a result, the extending and rigidifying of the asymmetric environment of the stereogenic centers is projected forward to the metal center. The asymmetrically disposed aryl groups define the chiral environment of the catalyst and the preferential orientation of binding of a substrate, as shown in Figure 3.11.¹³²

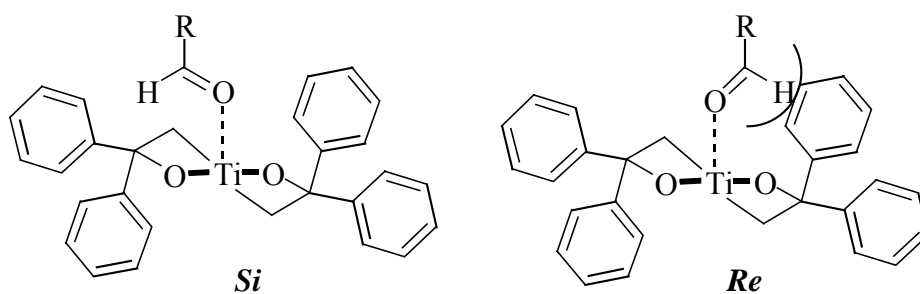
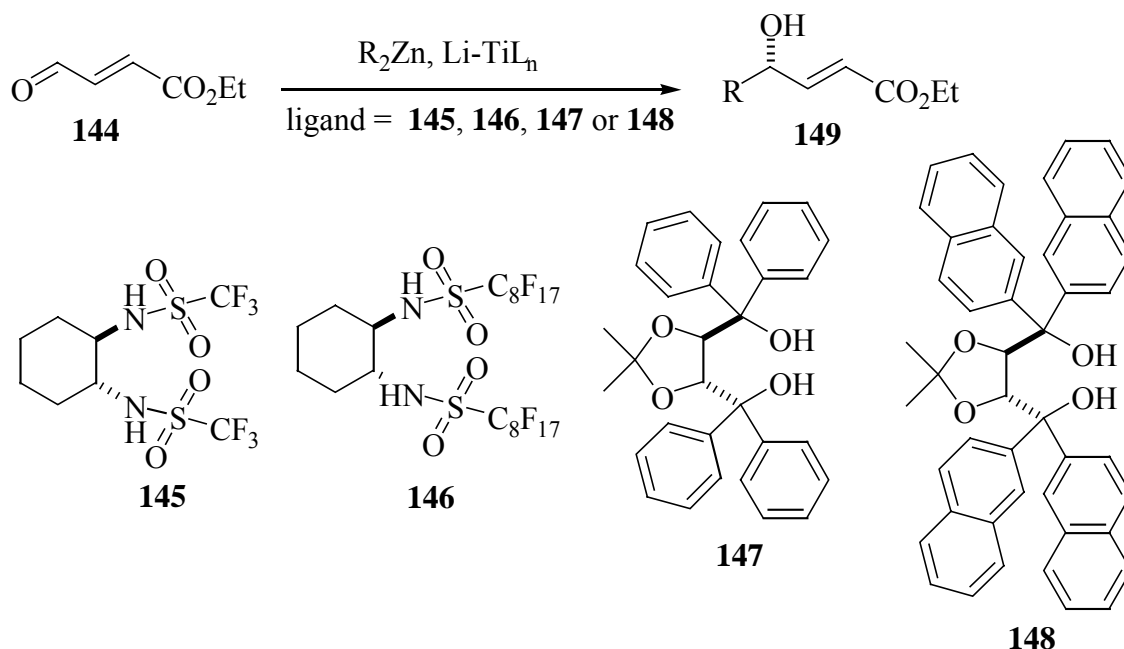

Figure 3.11: Effect of TADDOLate aryl groups on the binding of a substrate aldehyde. (The dioxolane moiety has been omitted for clarity.)¹³²

Synthetic Pathway

This part of the study began with the enantioselective alkylation of the commercially available ethyl (*E*)-4-oxobutenoate (**144**) with some selected chiral catalysts and the R_2Zn - $Ti(O-i-Pr)_4$ system. The chiral titanium compounds can be derived from chiral ligands with titanium(IV) isopropoxide ($Ti(O-i-Pr)_4$).



Scheme 3.32: Synthesis of the secondary alcohol **149** by enantioselective alkylation of commercially available aldehyde **144**.

The preparation of (*R,R*)-1,2-bis(trifluoromethanesulfonamide)cyclohexane (**145**)¹³³ started from (*R,R*)-1,2-diaminocyclohexane (**151**)¹³⁴, which was generated from (*R,R*)-1,2-diaminocyclohexane mono-(+)-tartarate salt (**150**) by treatment with 4 equivalents of KOH. The chiral free diamine was then condensed with trifluoromethanesulfonyl chloride to give the bis(sulfonamide) ligand¹¹⁹ **145** in 60% yield. Treatment of the chiral free diamine **151** with heptafluorooctanesulfonyl chloride under the same conditions gave bis(sulfonamide) ligand **146** (Scheme 3.33).

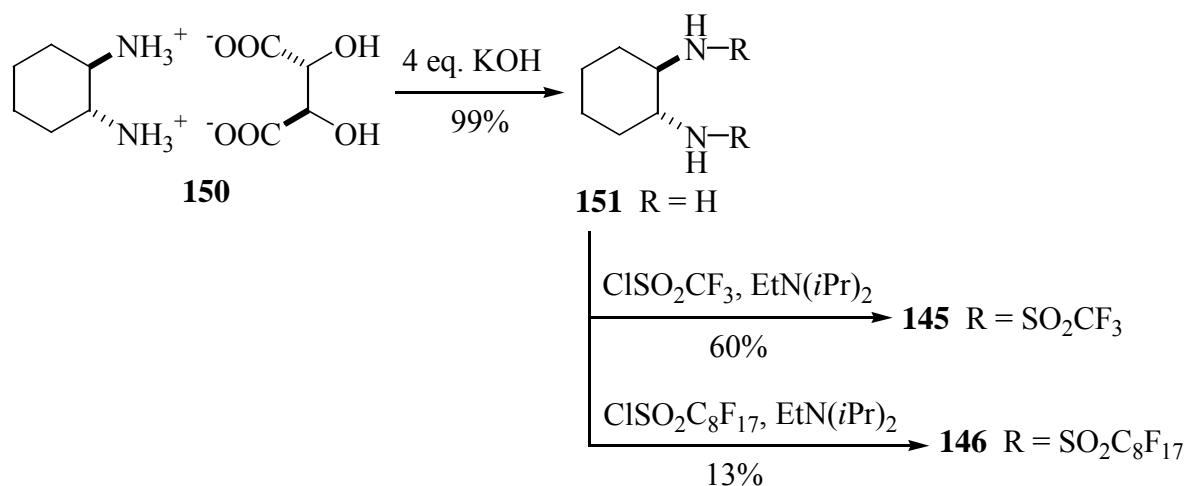

Scheme 3.33: Synthesis of chiral bis(sulfonamide) ligands **145** and **146**.

The chiral disulfonamide ligand **145** was initially selected for this study. This asymmetric alkylation of the aldehyde **144** should give the secondary alcohol **149** in high chemical yields and excellent enantiomeric purity.^{119,133,135} As a test reaction the alkylation of benzaldehyde with diethylzinc in the presence of ligand **145** was performed. As reported in literature^{117,119,125,127,135,136} an excellent result was obtained. The enantiomeric excess value (ee) was measured by HPLC as shown in Figure 3.12.

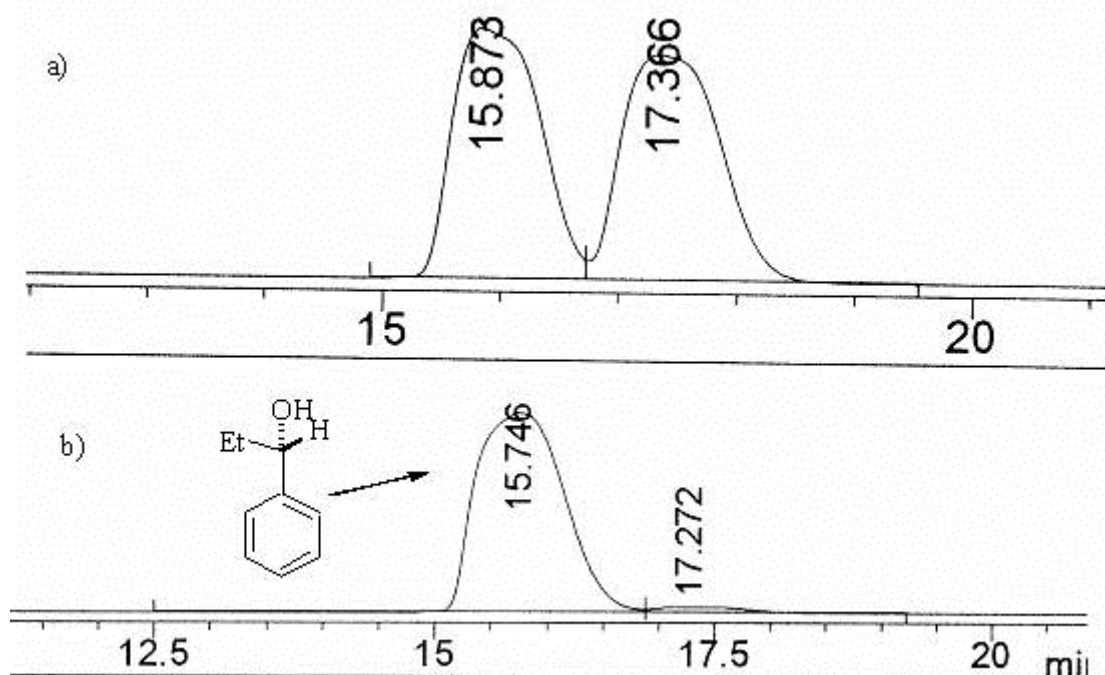
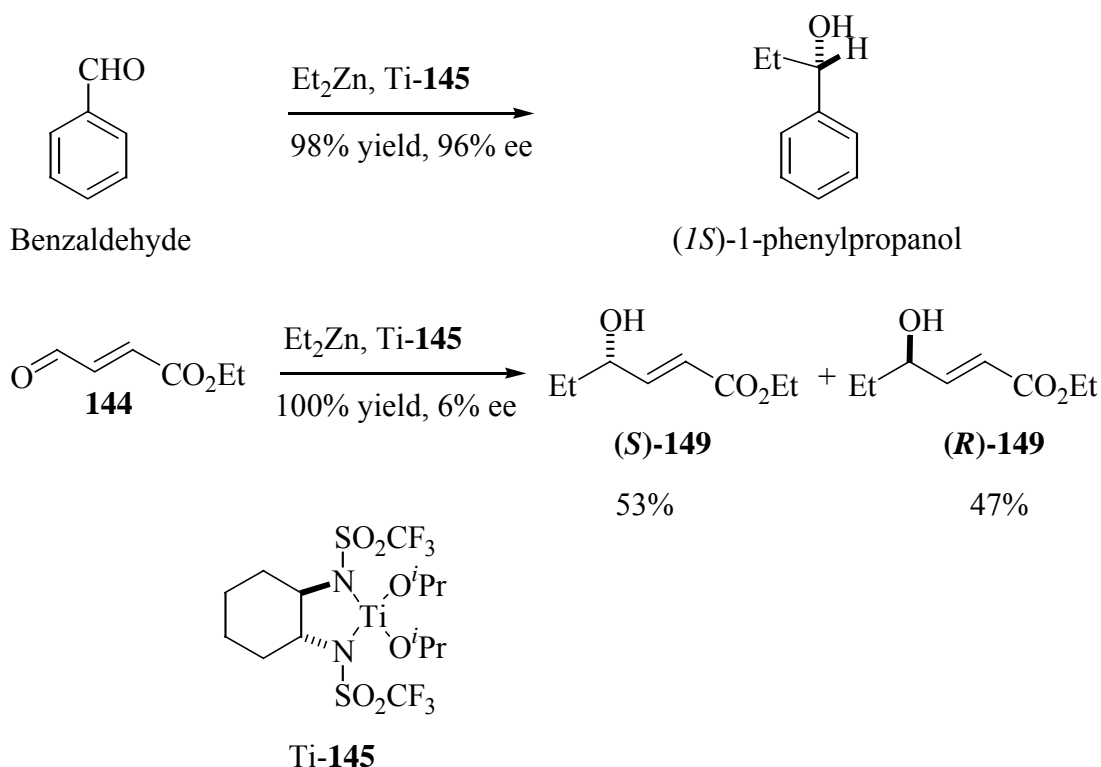

Figure 3.12: HPLC-Diagram: (a) *rac*-1-phenylpropanol. (b) (*S*)-1-phenylpropanol.^a

Note: a) device: HP 1100 series; column: chiracel OD-RH, 150 x 4.6 mm; eluent: NaCl solution (5 mM) / acetonitrile, gradient: 0-10-18-20-25 min with 20-80-80-99-99% acetonitrile, flow: 0.1 mL/min.

However, with the aldehyde **144** only a very low ee of 6% was obtained as determined by GC. The product was a nearly equal racemic mixture of two allylic alcohols (*S*)-**149** and (*R*)-**149**, in a ratio of enantiomers, in a ratio of 53:47. Nevertheless, the alkylation of **144** with diethylzinc in the presence of ligand **145** has never been reported.



Scheme 3.34: Ethylation by chiral disulfonamide catalyst **Ti-145**.

We thought that increasing the electron-withdrawing group on the amino functions might lead to a better catalyst.¹¹⁹ Therefore we targeted ligand **146**. However this ligand turned out to be too labile and unstable.

Another ligand that has been used for this study is TADDOL. Diethyl L-tartrate (**84**) was converted into the cyclic ketal ester **152** by condensation with 2,2-dimethoxypropane in the presence of a catalytic amount of toluenesulfonic acid.¹³⁷ The TADDOLs were obtained from the tartrate ester acetal precursor **152** and the corresponding aryl Grignard reagents. Here, the TADDOLs (-Ph)^{113a,118d,131b,138} **147** and (-Np)^{113a,118d,131b,138a-c} **148** were prepared as shown in Scheme 3.35.

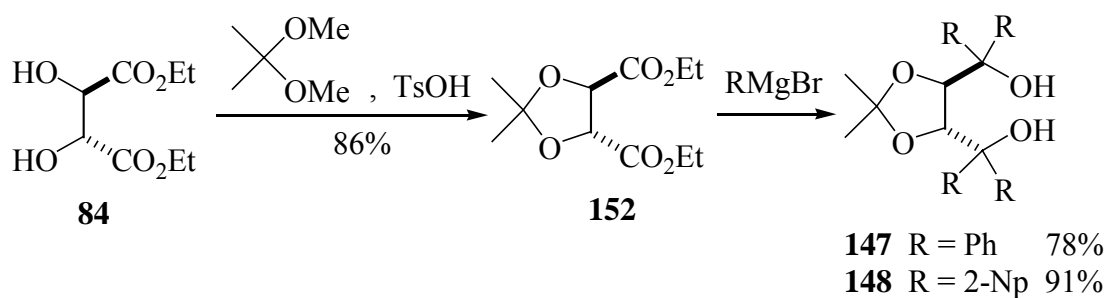

Scheme 3.35: Synthesis of chiral TADDOL ligands **147** and **148**.

The results obtained in the asymmetric alkylation^{118d} of aldehyde **144** with the different Ti-TADDOLates are summarized in Table 3.6. (see 3.3.4 Asymmetric Alkylation catalyzed by TADDOLates)

Table 3.6: Studies on ethylation of aldehyde **144** in the presence of Ti-TADDOLs.

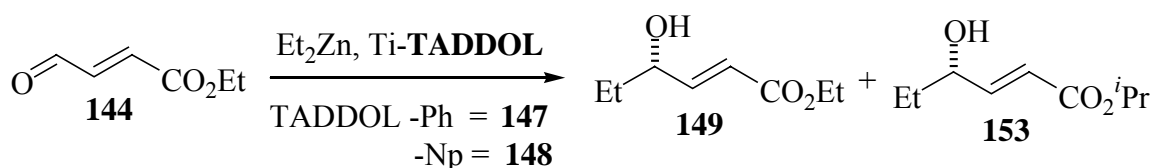

Equiv. of TADDOL		[%]			
(-Ph)	(-Np)	yield			ee of 149
147	148	149	153	149 + 153	
0.05	-	51	11	62	87
0.1	-	51	11	62	93
0.2	-	47	11	58	95
-	0.01	57	11	68	77
-	0.1	63	11	74	98
-	0.2	64	11	75	98

Note: a) The enantiomeric excess values (ee) were measured by GC.

The results listed in Table 3.6 reveal some informative data. Although iso-propyl hexenoate **153**¹³⁹ was obtained as the side product from the synthesis of chiral secondary alcohol **149**^{139,140}, the subsequent steps allowed the preparation of the key building block

156 from both products. Thus, both were employed for the next procedure without any separation. Under the above conditions products **149** and **153** were generally obtained in good yield (58-75%) and high enantiomeric excess (77-98%). Among the two ligands, TADDOL (-Np) **148** showed slightly better results. This catalyst was therefore selected for further investigation and the result of the alkylation under the optimized conditions is shown in Scheme 3.36. The enantiomeric excess values (ee) of **154**^{140,141} was measured by GC-MS.

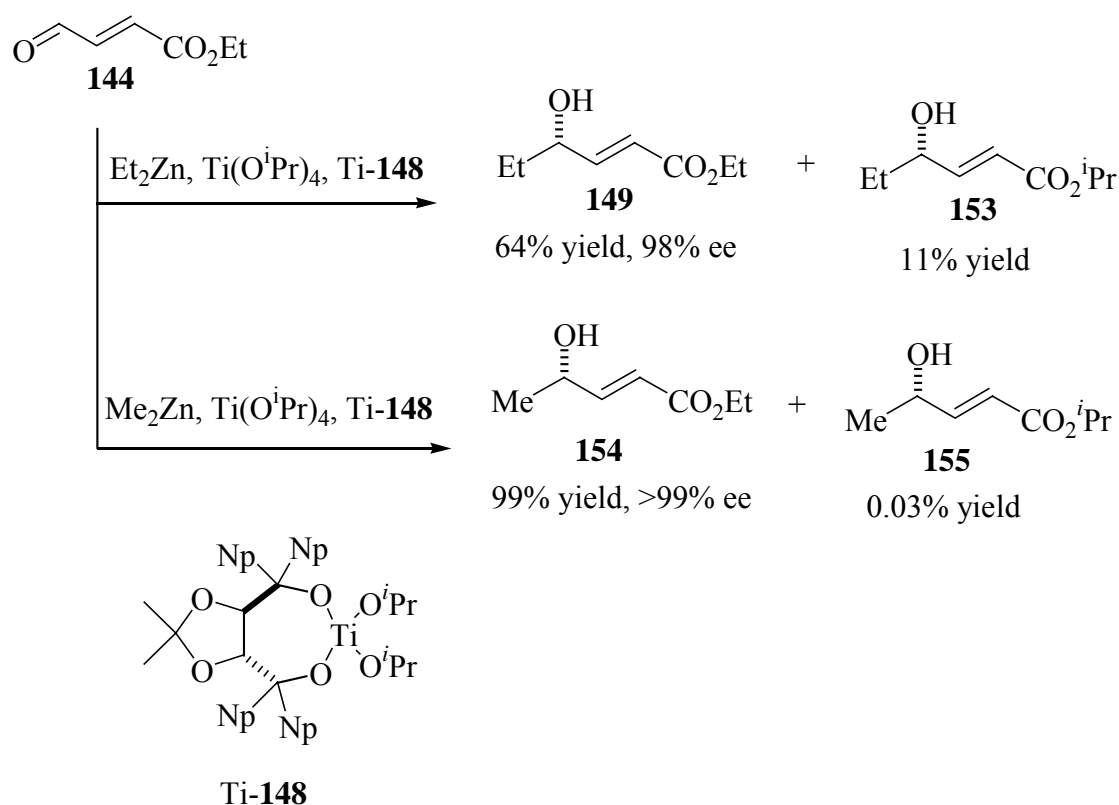

Scheme 3.36: Alkylation of aldehyde **144** in the presence of Ti-**148**.

The mixture of allylic alcohols **149** and **153** was transformed smoothly to the hydroxyesters **154**^{116,142} and **155**¹⁴³ by hydrogenation of the double bond.^{141f,144} Subsequent heating of the hydroxy esters under acidic conditions led to the lactone **156**.^{116,145}

Since the methyl derivative of lactone **156** was used in the White synthesis²⁶ one could use a similar strategy to convert **156** to the analog **143**. Due to time constraints this was not further pursued. The sequence leading to the key building block **156** is shown in Scheme 3.37.

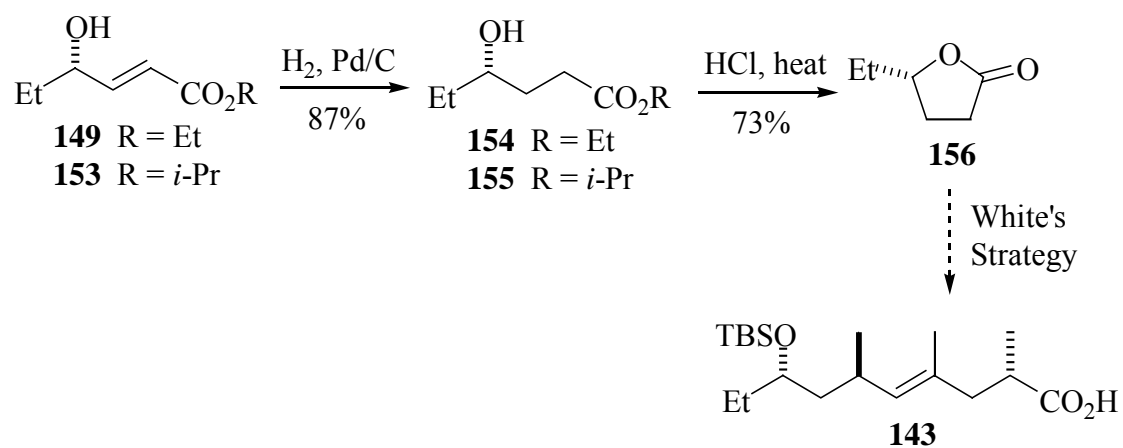

Scheme 3.37: Synthesis of the key building block **156**.

4 CONCLUSION

The core of this dissertation was the development of an economically feasible asymmetric synthesis of the protected 8-hydroxy-2,4,6-trimethyl-4-nonenoic acid (**3b**). This would correspond to a formal total synthesis of jasplakinolide. This moiety, related to that found in the geodiamolide family of natural products, consists of 12 carbons with three chiral centers and one geometric configuration as a double bond in the backbone.

To effect the synthesis for the natural derivative, a methodology of route **A** was investigated. To achieve chain extension toward the ω -hydroxy acid **3b**, acetoacetate **64** was selected as the starting material. While the route was still not optimal, it provided the acid in 15 steps which an overall yield of 20%. This allowed the laboratory synthesis of 2 g of this material. Key steps of this synthesis included: yeast reduction, the Charette method for diastereoselective cyclopropanation, a cross alkene metathesis reaction, and finally an Evans alkylation resulting in the 8-hydroxy acid derivative **3b**. The attempts to attain higher yields of hydroxy acid **3b** over less steps via the cross coupling metathesis of olefin **60** with various 2-methyl-olefins (**99-104**) containing the remainder of the basic skeleton, were unsuccessful. However, we found that only methyl methacrylate (**92**) was suitable for the cross-metathesis.

In a complementary study, three more methods (routes **B-D**) for the synthesis of derivatives of the 8-hydroxy acid were investigated. The fundamental steps in these strategies are: a Noyori asymmetric reduction, hydrolytic kinetic resolution (HKR), and enantioselective alkylation of an aldehyde catalyzed by TADDOL derivatives. In route **B**, the yeast reduction of acetoacetate (**64**, routes **A**) was replaced by the Noyori reduction of the β -ketoester. In this way ethyl 3-oxoheptanoate (**106**) could be easily converted to building block **113** in good yield. Route **C** is based on the hydrolytic kinetic resolution (HKR), catalyzed by a chiral (salen)Co complex of a racemic epoxide. The complex was derived from the chiral ligand **119** with cobalt(II)acetate tetrahydrate ($\text{Co(II)(OAc)}_2 \cdot 4 \text{H}_2\text{O}$). This route started from (\pm)-epichlorohydrin (**121**) by the HKR technique. A subsequent alkylation of the dithianyl anion with epichlorohydrin, followed by Brook rearrangement produced compound **120**. Hydrolysis of the dithiane group then resulted in the aldehyde **127**. The further steps forward the target molecule **118** were performed similar to the procedure from route **A**. Route **D** is the study of the enantioselective alkylation of ethyl (*E*)-4-oxobutenoate (**144**) with some chiral catalysts (**145**, **147** and **148**)

and the $R_2Zn-Ti(O-i-Pr)_4$ system. In this part of the study, the key building block, lactone **156** was obtained in a very efficient way. These three additional routes were supposed to provide a wide range of acid-like molecules in good quality and quantity. The synthetic analysis of the 8-hydroxy acid and acid-like molecules of jasplakinolide, as discussed, is shown in Figure 4.1.

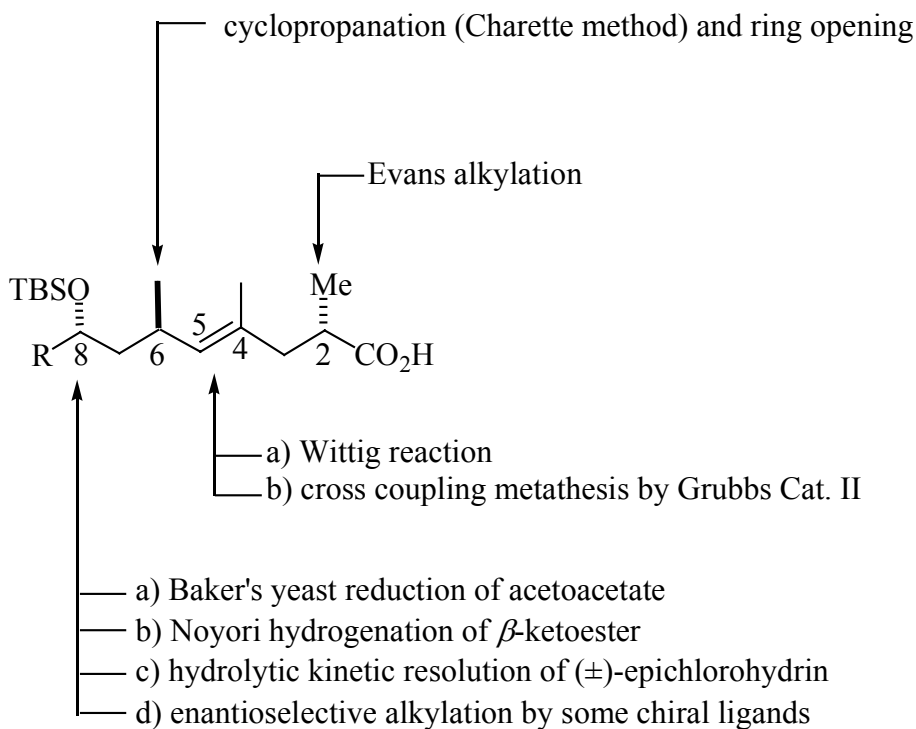

Figure 4.1: The synthetic analysis of the 8-hydroxy acid and acid-like molecules of jasplakinolide.

From this study, the chemistry performed allows the synthesis of the important bioactive marine cyclodepsipeptide jasplakinolide from commercially available and inexpensive starting materials. Four approaches to the polypropionate-like fragment were developed. The product was planned to be used for the construction of novel macrocyclic systems. The chemistry developed should be applicable to the synthesis of a wide range of novel peptide-polypropionate macrocycles. In summery, it can be said that acid **3** is a tough synthetic target and an interesting lead compound for conformational design. Lessons learnt from this study will direct the design of simpler analogs. This will be the subject of future investigations.

5 EXPERIMENTAL PART

5.1 General Remarks

5.1.1 Chemicals and Working Technique

The chemicals were purchased from the firms Acros, Aldrich, Fluka, Lancaster, Avocado and Merck. They were used directly without further purification if nothing else was mentioned. All solvents were purified prior to use by standard methodology except for those which were reagent grades. The applied petrol ether fraction had a b.p. of 40-60 °C. Anhydrous solvents were obtained as follows: THF, diethyl ether and toluene by distillation from sodium and benzophenone; dichloromethane and chloroform by distillation from calcium hydride; dimethylformamide and dimethylsulfoxide by vacuum distillation from calcium hydride; acetone by distillation from phosphor(V)-oxide. Absolute triethylamine and pyridine were distilled from calcium hydride prior to use. 1,2-dimethoxyethane was distilled prior to use. Unless mentioned, all the reactions were carried out under an nitrogen atmosphere and the glass material was pre-dried by flame drying under high vacuum (oil pump RV 5, Edwards). All the chemicals, which were air or water sensitive, were stored under inert atmosphere. Compounds which are not described in the experimental part, were prepared according to the literature.

5.1.2 NMR-Spectroscopy

The spectra were measured on a Bruker Avance 400 spectrometer which operated at 400 MHz for ^1H and 100 MHz for ^{13}C nuclei, respectively. ^1H and ^{13}C NMR spectra were performed in deuterated solvent and chemical shifts were assigned by comparison with the residual proton and carbon resonance of the solvent and tetramethylsilane (TMS) as an internal reference ($\delta = 0$). Data are reported as follows: chemical shift (multiplicity: s = singlet, d = doublet, t = triplet, m = multiplet, br = broadened; J = coupling constant (Hz), integration, peak assignment).

5.1.3 Mass Spectrometry

Mass spectra were recorded on a Finnigan Triple-Stage-Quadrupol Spectrometer (TSQ-70) from Finnigan-Mat. High-resolution mass spectra were measured on a modified AMD Intectra MAT 711 A from the same company. The used mass spectrometric ionization methods were electron-impact (EI), fast-atom bombardment (FAB) or field-desorption (FD). FT-ICR-mass spectrometry and HR-FT-ICR mass spectra were measured on an APEX 2 spectrometer from Bruker Daltonic with electrospray ionization method (ESI). Some of the mass spectra were also measured on an Agilent 1100 series LC/MSD (API-ES). Significant fragments are reported as follows: m/z (relative intensity).

5.1.4 Infrared Spectroscopy

The FT-IR spectra were recorded on a Fourier Transformed Infrared Spectrophotometer model Jasco FT/IR-430 from the company Jasco. Solid samples were pulverized with potassium bromide and percent reflection (R%) was measured. The percent transmittance (T%) of liquid or oily substances was measured in film between potassium bromide tablets. Absorption band frequencies are reported in cm^{-1} .

5.1.5 Polarimetry

Optical rotations were measured on a JASCO Polarimeter P-1020. They are reported as follows: $[\alpha]^{temperature}D$ (concentration, solvent). The unit of c is g/100 mL. As a solvent was used anhydrous CH_2Cl_2 or CHCl_3 . For the measurement was used the sodium D line = 589 nm.

5.1.6 Melting Points

Melting points were determined with a Büchi Melting Point B-540 apparatus and were not corrected.

5.1.7 Chromatographic Methods

Flash column chromatography was performed using flash silica gel (40-63 μm , 230-400 mesh ASTM) from Macherey-Nagel.

Gaschromatography was performed on a CHROMPACK CP 9000 using a flame ionization detector, and carrier gas H_2 . For GC-MS coupled chromatography, GC-system from Series 6890 with an Injector Series 7683 and MS-detector Series 5973 from Hewlett Packard was used, with EI method, and carrier gas He. Analytical HPLC was performed on a Hewlett Packard HP 1100 system.

Analytical thin-layer chromatography (TLC) was performed on aluminum sheets pre-coated with silica gel 60 F₂₅₄ plates (Merck) or Polygram Sil G/UV₂₅₄ (Macherey-Nagel). The compounds were visualized by UV₂₅₄ light and the chromatography plates were developed with an aqueous solution of molybdophosphorous acid or aqueous solution of potassium permanganate (heating on a hot-plate). For preparation of the molybdate solution were used 20 g ammonium molybdate $[(\text{NH}_4)_6\text{Mo}_7\text{O}_{24} \times 4\text{H}_2\text{O}]$ and 0.4 g Cer $(\text{SO}_4)_2 \times 4\text{H}_2\text{O}$ dissolved in 400 mL 10% H_2SO_4 . The potassium permanganate solution was prepared from 2.5 g KMnO_4 and 12.5 g Na_2CO_3 in 250 mL H_2O .

5.2 Synthesis of the 8-Hydroxy Acid of Jasplakinolide

(2*S*,4*E*,6*R*,8*S*)-8-[[*tert*-Butyl(dimethyl)silyl]oxy]-2,4,6-trimethylnon-4-enoic acid (3b)

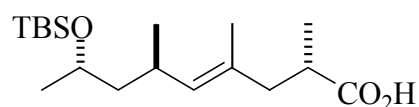

A cooled (0 °C) solution of the oxazolidinone **96** (73 mg, 0.15 mmol) in THF (2.5 mL) was treated with H_2O_2 (35% by weight, 68 μL , 0.60 mmol), then with a solution of $\text{LiOH} \cdot \text{H}_2\text{O}$ (13 mg, 0.30 mmol) in H_2O (1 mL). The solution was stirred at 0 °C for 1.5 h. After TLC indicated completion of the hydrolysis, a mixture of saturated Na_2SO_3 (2 mL) and saturated NaHCO_3 (2 mL) was added at 0 °C. The mixture was partially concentrated and then diluted with H_2O (2 mL). The aqueous solution was extracted with CH_2Cl_2 (3 x 5 mL). The combined organic extracts were dried (MgSO_4), filtered and concentrated. The crude product was purified by flash chromatography (petroleum ether/ Et_2O , 6:1) to afford

the acid **3b** as a colorless oil (49 mg, 100%). TLC (petroleum ether/ethyl acetate, 6:1): $R_f = 0.57$; $[\alpha]_D^{22} -9.0$ (c 0.23, CH_2Cl_2) {Ref.¹⁷ $[\alpha]_D^{25} -9.2$ (c 1.1, CHCl_3)}

^1H NMR (400 MHz, CDCl_3): $\delta = 0.03$ (s, 6H, SiCH_3), 0.87 (s, 3H, CH_3), 0.87 (s, 9H, $\text{SiC}(\text{CH}_3)_3$), 1.08 (d, $J = 6.3$ Hz, 3H, CH_3), 1.10 (d, $J = 7.3$ Hz, 3H, CH_3), 1.25-1.31 (m, 1H, H-7), 1.39-1.45 (m, 1H, H-7), 1.59 (s, 3H, CH_3), 1.98-2.04 (m, 1H, H-3), 2.35-2.41 (m, 1H, H-3), 2.38-2.46 (m, 1H, H-6), 2.56-2.65 (m, 1H, H-2), 3.70-3.78 (m, 1H, H-8), 4.96 (d, $J = 9.5$ Hz, 1H, H-5), 11.43 (s, br, 1H, COOH).

^{13}C NMR (100 MHz, CDCl_3): $\delta = -4.8$, -4.4 (SiCH_3), 15.6 (C-4a), 16.1 (C-2a), 18.3 ($\text{SiC}(\text{CH}_3)_3$), 20.9 (C-6a), 23.6 (C-9), 25.9 ($\text{SiC}(\text{CH}_3)_3$), 29.1 (C-6), 37.8 (C-2), 43.8 (C-3), 47.5 (C-7), 66.7 (C-8), 129.9 (C-5), 134.3 (C-4), 183.0 (C-1).

IR (neat): $\tilde{\nu} = 2957, 2929, 2857, 1709, 1255 \text{ cm}^{-1}$.

(2*R*,4*S*)-4-[[*tert*-Butyl(dimethyl)silyl]oxy]-2-methylpentanal (20**)**

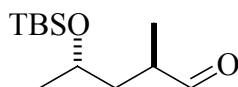

The ozonide **89** was reduced to the aldehyde **20** by the addition of dimethyl sulfide (60 mL, 2 mL/mmol). The solution was allowed to warm to room temperature and stirred for 7 days, then washed with H_2O (2 x 50 mL) and brine (2 x 50 mL), respectively. The organic layer was dried (MgSO_4), filtered and concentrated. The residue was purified by flash chromatography (petroleum ether/ Et_2O , 15:1) to afford aldehyde **20** as a colorless oil (6.71 g, 97%, over 2 steps from alkene **80**). TLC (petroleum ether/ethyl acetate, 16:1): $R_f = 0.47$; $[\alpha]_D^{24} +6.20$ (c 0.89, CHCl_3) {Ref.^{28b} $[\alpha]_D^{25} +23.2$ (c 0.06, CHCl_3)}

^1H NMR (400 MHz, CDCl_3): $\delta = 0.04$ (s, 6H, SiCH_3), 0.05 (s, 6H, SiCH_3), 0.87 (s, 9H, $\text{SiC}(\text{CH}_3)_3$), 1.09 (d, $J = 6.0$ Hz, 3H, CH_3), 1.16 (d, $J = 6.1$ Hz, 3H, H-5), 1.47-1.54 (m, 1H, H-3), 1.80-1.87 (m, 1H, H-3), 2.47-2.57 (m, 1H, H-4), 3.83-3.96 (m, 1H, H-4), 9.61 (s, 1H, H-1).

^{13}C NMR (100 MHz, CDCl_3): $\delta = -4.8$, -4.1 (SiCH_3), 13.4 (CH_3), 18.0 ($\text{SiC}(\text{CH}_3)_3$), 24.3 (C-5), 25.8 ($\text{SiC}(\text{CH}_3)_3$), 40.4 (C-3), 43.5 (C-2), 66.1 (C-4), 205.2 (C-1).

IR (neat): $\tilde{\nu} = 2957, 2930, 2858, 1728, 1255$.

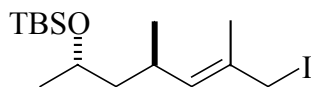
(2E,4R,6S)-6-[[*tert*-Butyl(dimethyl)silyl]oxy]-1-iodo-2,4-dimethylhept-2-ene (59)

A solution of the crude mesylate **94** (274 mg, 0.78 mmol) in dry acetone (5 mL) was treated with sodium iodide (1.05 g, 7.0 mmol) at 0 °C. After being stirred for 3 h at room temperature, the mixture was diluted with petroleum ether (10 mL) and washed with H₂O (5 mL). The aqueous phase was extracted with Et₂O (3 x 5 mL). The combined organic layers were washed with brine, dried (MgSO₄), filtered and concentrated. The crude product was purified by short flash chromatography (petroleum ether/Et₂O, 1:1) to yield the iodide **59** as a pale yellow oil (292 mg, 94% from **93**). TLC (petroleum ether/ethyl acetate, 100:1): R_f = 0.40.

¹H NMR (400 MHz, CDCl₃): δ = 0.04 (s, 6H, SiCH₃), 0.88 (s, 9H, SiC(CH₃)₃), 0.90 (d, *J* = 4.0 Hz, 3H, H-4a), 1.10 (d, *J* = 6.1 Hz, 3H, H-7), 1.26-1.33 (m, 1H, H-5), 1.39-1.46 (m, 1H, H-5), 1.76 (s, 3H, H-2a), 2.37-2.46 (m, 1H, H-4), 3.71-3.77 (m, 1H, H-6), 3.92 (s, 2H, H-1), 5.44 (d, *J* = 9.6 Hz, 1H, H-3).

¹³C NMR (100 MHz, CDCl₃): δ = -4.8, -4.3 (SiCH₃), 15.5 (CH₃C=CH), 17.0 (C-1), 18.1 (SiC(CH₃)₃), 19.8 (CH₃CH), 23.8 (C-7), 25.9 (SiC(CH₃)₃), 29.6 (C-4), 47.0 (C-5), 66.3 (C-6), 131.3 (C-2), 136.2. (C-3).

IR (neat): $\tilde{\nu}$ = 2957, 2928, 2857, 1361, 1256 cm⁻¹.

HRMS: calcd. for C₁₅H₃₁OISiNa 405.10867, found 405.10812.

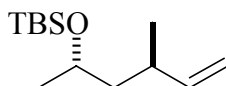
(3R,5S)-5-[[*tert*-Butyl(dimethyl)silyl]oxy]-3-methylhex-1-ene (60)

A solution of the iodide **83** (15.6 g, 44.0 mmol) in dry Et₂O (250 mL) containing 4 Å molecular sieves (7.7 g) and TMEDA (13.2 mL, 88 mmol) was treated with *n*-BuLi (2.5 M in hexane, 35.2 mL, 88 mmol) at -78 °C. The resulting mixture was stirred at -78 °C for 1 h, then the temperature was raised to -30 °C over 2 h. The reaction was quenched with

H₂O (100 mL). The layers were separated and the aqueous layer was extracted with Et₂O (3 x 75 mL). The combined organic layers were successively washed with 10% HCl (100 mL), saturated NaHCO₃ solution (100 mL), H₂O and brine, respectively. The organic layer was dried (MgSO₄), filtered, and concentrated. The crude product was purified by flash chromatography (petroleum ether) to give the alkene **60** as a colorless oil (7.33 g, 73% yield, > 98% de). TLC (petroleum ether): R_f = 0.44; [α]_D²⁶ +3.91 (*c* 0.98, CH₂Cl₂).

¹H NMR (400 MHz, CDCl₃): δ = 0.04 (s, 6H, SiCH₃), 0.87 (s, 9H, SiC(CH₃)₃), 0.98 (d, *J* = 6.7 Hz, 3H, CH₃), 1.12 (d, *J* = 6.0 Hz, 3H, H-6), 1.24-1.29 (m, 1H, H-4), 1.49-1.56 (m, 1H, H-4), 2.19-2.26 (m, 1H, H-3), 3.78-3.85 (m, 1H, H-5), 4.90 (d, *J* = 10.3 Hz, 1H, H-1), 4.93 (d, *J* = 17.2 Hz, 1H, H-1), 5.65-5.74 (m, 1H, H-2).

¹³C NMR (100 MHz, CDCl₃): δ = -4.7, -4.3 (SiCH₃), 18.1 (SiC(CH₃)₃), 20.1 (CH₃), 23.7 (C-6), 25.9 (SiC(CH₃)₃), 34.4 (C-3), 46.7 (C-4), 66.5 (C-5), 112.2 (C-1), 144.8 (C-2).

IR (neat): $\tilde{\nu}$ = 2957, 2927, 1463 cm⁻¹.

HRMS: calcd. for C₁₃H₂₈O₂Si [M - 1]⁺ 227.183116, found 227.183745.

[(1*S*,2*R*)-2-((2*S*)-2-[[*tert*-Butyl(dimethyl)silyl]oxy]propyl)cyclopropyl]methanol (**61**)



To a solution of CH₂Cl₂ (300 mL) and 1,2-dimethoxyethane (DME) (10.4 mL, 100 mmol) was added a solution of diethylzinc (1.0 M in hexane, 100 mL, 100 mmol) at -10 °C followed by the dropwise addition of CH₂I₂ (16.1 mL, 200 mmol) over 15-20 min while maintaining the internal temperature between -8 and -12 °C. After complete addition, the resulting clear solution was stirred for 10 min at -10 °C before a solution of dioxaborolane ligand **67** (16.21 g, 60 mmol) in CH₂Cl₂ (50 mL, 1.2 M) was added via cannula over a 15-20 min period while maintaining the internal temperature below -5 °C. This was followed by the dropwise addition of alcohol **81** (11.5 g, 50.0 mmol), dissolved in CH₂Cl₂ (50 mL) while maintaining the internal temperature below -5 °C. After being stirred for 0.5 h at -10 °C, the mixture was allowed to reach room temperature and stirred for 15 h. The reaction was quenched with saturated NH₄Cl solution (50 mL) and 10% of HCl (200 mL) and the mixture was extracted with Et₂O (3 x 100 mL). The combined organic layers were added to a mixture of 2 N NaOH (300 mL) and H₂O₂ (30%, 50 mL). The biphasic solution was

stirred for 5 min and then the layers were separated. The organic phase was washed with 10% of HCl (250 mL), Na₂SO₃ (250 mL), NaHCO₃ (250 mL), and brine (250 mL). After drying (MgSO₄), filtration and concentration of the organic layer under reduced pressure, the crude product was purified by flash chromatography (petroleum ether/Et₂O, 5:1) to afford **61** as a colorless oil (11.73 g, 96%, the diastereomeric ratio was determined in the next step). TLC (petroleum ether/ethyl acetate, 4:1): R_f = 0.47; [α]_D²⁶ +22.2 (*c* 0.97, CH₂Cl₂).

¹H NMR (400 MHz, CDCl₃): δ = 0.04, 0.05 (2 s, 3H each, SiCH₃), 0.29-0.39 (m, 2H, cyclopropane CH₂), 0.63-0.72 (m, 1H, H-2'), 0.83-0.90 (m, 2H, H-1'), 0.88 (s, 9H, SiC(CH₃)₃), 1.12-1.19 (m, 1H, H-1''), 1.15 (d, *J* = 6.1 Hz, 3H, CH₃), 1.53-1.60 (m, 1H, H-1''), 3.37-3.52 (m, 2H, CH₂OH), 3.85 (q, *J* = 6.1 Hz, 1H, CHOR).

¹³C NMR (100 MHz, CDCl₃): δ = -4.7, -4.5 (SiCH₃), 9.9 (cyclopropane CH₂), 13.8 (cyclopropane C-2'), 18.1 (SiC(CH₃)₃), 21.1 (cyclopropane C-1'), 23.6 (CH₃), 25.9 (SiC(CH₃)₃), 43.5 (CH₂), 67.1 (CHOR), 68.7 (CH₂OH).

IR (neat): $\tilde{\nu}$ = 3348 (br), 2956, 2929, 2857, 1255 cm⁻¹.

HRMS: calcd. for C₁₃H₂₈O₂SiNa 267.17508, found 267.17513.

Methyl (2*E*,5*S*)-5-[[*tert*-butyl(dimethyl)silyl]oxy]-2-hexenoate (**62**)

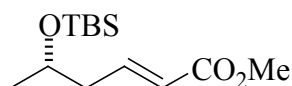

A mixture of the aldehyde **79** (51 mg, 0.25 mmol) and carbomethoxymethylene triphenylphosphorane (**80**) (92 mg, 0.28 mmol) in benzene (2 mL) was refluxed overnight (80 °C, 16 h). The resulting precipitate was removed by filtration and washed with cold (0 °C) Et₂O. The filtrate was concentrated and the residue purified by chromatography (petroleum ether/Et₂O, 15:1) to afford the enoate **62** as a colorless oil (67 mg, 97%, trans/cis, 33:1 as determined by relative peak heights in the ¹H NMR spectrum). The reaction also was performed 17 g scale of the aldehyde **79** (17.3 g, 86 mmol) with carbomethoxymethylene triphenylphosphorane (**80**) (34.4 g, 103 mmol) in benzene (300 mL). In this case afforded 18.8 g (80%) of enoate **62**. TLC (petroleum ether/ethyl acetate, 16:1): R_f = 0.45; [α]_D²⁶ +7.78 (*c* 0.98, CHCl₃) {Ref.^{63c} [α]_D¹⁸ +8.94 (*c* 1.01, CHCl₃)}.

¹H NMR (400 MHz, CDCl₃): δ = 0.01, 0.02 (2 s, 3H each, SiCH₃), 0.85 (s, 9H, SiC(CH₃)₃), 1.13 (d, *J* = 6.1 Hz, 3H, H-6), 2.27-2.31 (m, 2H, H-4), 3.70 (s, 3H, OCH₃), 3.86-3.94 (m, 1H, H-5), 5.81 (d, *J* = 15.7 Hz, 1H, H-2), 6.93 (dt, *J* = 15.7, 7.7 Hz, 1H, H-3).

¹³C NMR (100 MHz, CDCl₃): δ = -4.9, -4.6 (SiCH₃), 18.0 (SiC(CH₃)₃), 23.7 (C-6), 25.8 (SiC(CH₃)₃), 42.4 (C-4), 51.3 (CH₃), 67.6 (C-5), 122.8 (C-2), 146.3 (C-3), 166.8 (C-1).

IR (neat): $\tilde{\nu}$ = 2954, 2930, 1729, 1258 cm⁻¹.

Ethyl (3*R*)-3-hydroxybutanoate (**63**)³⁶

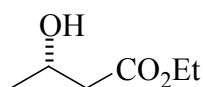

A solution of 180 g of sucrose (commercially available sugar) in H₂O (950 mL) was stirred at room temperature for 5 min, until the solution became homogeneous. Thereafter 120 g of baker's yeast was added to the solution. The mixture was stirred for 1 h at 30 °C, ethyl acetoacetate (**64**, 12.0 g, 92 mmol) was added, and the suspension was stirred for another 24 h at room temperature. A warm (ca. 40 °C) solution of 120 g of sucrose in H₂O (60 mL) was then added, followed 1 h later by additional ethyl acetoacetate (**64**) (12.0 g, 92 mmol). Stirring was continued for 72 h at room temperature, reaction was complete by TLC. Then celite (48 g) was added and the resulting heterogeneous solution was stirred for 0.5 h and then filtered. The filtrate was washed with H₂O (120 mL). It was saturated with NaCl and extracted with Et₂O (5 x 150 mL). The combined organic phase was dried (MgSO₄), filtered, and concentrated. The crude product was purified by distillation at 65-75 °C (15-20 mbar) to give the hydroxy ester **63** as a colorless oil (17.8 g, 135 mmol, 73% yield, 89% ee). TLC (petroleum ether/ethyl acetate, 2:1): R_f = 0.55; [α]_D²⁵ +33.3 (*c* 1.14, CH₂Cl₂) {Ref.³⁶ [α]_D²⁵ +37.2 (*c* 1.3, CHCl₃)}.

¹H NMR (400 MHz, CDCl₃): δ = 1.15 (d, *J* = 6.3 Hz, 3H, H-4), 1.19 (t, *J* = 7.2 Hz, 3H, CH₃), 2.36 (dd, *J* = 14.5, 5.4 Hz, 1H, H-2), 2.38 (dd, *J* = 14.5, 7.5 Hz, 1H, H-2), 3.33 (s, 1H, OH), 4.04-4.13 (m, 2H, CH₂), 4.07-4.15 (m, 1H, H-3).

¹³C NMR (100 MHz, CDCl₃): δ = 14.5 (CH₃), 22.8 (C-4), 43.3 (C-2), 61.0 (CH₂), 64.6 (C-3), 173.2 (C-1).

IR (neat): $\tilde{\nu}$ = 3446 (br), 2978, 1735, 1375, 1254 cm⁻¹.

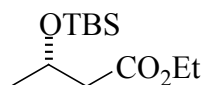
Ethyl (3S)-3-[[*tert*-butyl(dimethyl)silyl]oxy]butanoate (78)

To a stirred solution of alcohol **63** (38.3 g, 0.29 mol) in CH₂Cl₂ (500 mL) was added imidazole (39.5 g, 0.58 mol) at 0 °C and the mixture stirred for 5 min resulting in a homogeneous solution. Subsequently, *tert*-butyldimethylsilyl chloride (52.6 g, 0.348 mol) was added and the whole mixture stirred for 0.5 h at 0 °C and then at room temperature for 21 h. The reaction mixture was diluted with H₂O, the layers were separated and the aqueous layer extracted with CH₂Cl₂ (4 x 75 mL). The combined organic layers were washed with brine, dried (MgSO₄), filtered, and concentrated to give **78** as a colorless oil (71.4 g, 100% yield). TLC (petroleum ether/ethyl acetate, 19:1): R_f = 0.44; [α]_D²⁶ +22.0 (*c* 0.97, CHCl₃) {Ref.^{61a} [α]_D²³ +28 (*c* 1.5, CHCl₃)}.

¹H NMR (400 MHz, CDCl₃): δ = 0.01, 0.03 (2 s, 3H each, SiCH₃), 0.83 (s, 9H, SiC(CH₃)₃), 1.17 (d, *J* = 6.1 Hz, 3H, H-4), 1.23 (t, *J* = 7.1 Hz, 3H, CH₃), 2.33 (dd, *J* = 14.5, 5.3 Hz, 1H, H-2), 2.44 (dd, *J* = 14.5, 7.6 Hz, 1H, H-2), 4.04-4.13 (m, 2H, CH₂), 4.21-4.29 (m, 1H, H-3).

¹³C NMR (100 MHz, CDCl₃): δ = -5.1, -4.6 (SiC(CH₃)₃), 14.2 (CH₃), 17.9 (SiC(CH₃)₃), 23.9 (C-4), 25.7 (SiC(CH₃)₃), 44.9 (C-2), 60.2 (CH₂), 65.8 (C-3), 171.6 (C-1).

IR (neat): $\tilde{\nu}$ = 1739, 1255, 1183 cm⁻¹.

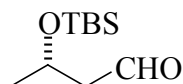
(3S)-3-[[*tert*-Butyl(dimethyl)silyl]oxy]butanal (79)

To a solution of ester **78** (123 mg, 0.5 mmol) in CH₂Cl₂ (5 mL) was added DIBAL-H (1.0 M in hexane, 0.55 mL, 0.55 mmol) dropwise at -78 °C. After being stirred for 0.5 h at -78 °C, the temperature was raised to -30 °C, methanol (0.5 mL) was then added, the cooling bath removed, and the mixture warmed to 0 °C. A saturated solution of potassium sodium tartarate was added and the mixture was extracted with Et₂O (3 x 5 mL). The combined organic layers were washed with brine, dried (MgSO₄), filtered and

concentrated. The residue was purified by flash chromatography (petroleum ether/Et₂O, 8:1) to yield 101 mg (100%) of aldehyde **79** as a colorless oil. The reaction also was performed 12 g scale of ester **78** (12.3 g, 50 mmol) with DIBAL-H (1.0 M in hexane, 55 mL, 55 mmol) in CH₂Cl₂ (100 mL). In this case afforded 9.26 g (92%) of aldehyde **79**. TLC (petroleum ether/ethyl acetate, 6:1): R_f = 0.47; [α]_D²⁷ +14.0 (c 1.0, CHCl₃) {Ref.⁶² [α]_D²³ +19 (c 2.0, CHCl₃)}.

¹H NMR (400 MHz, CDCl₃): δ = -0.02, 0.00 (2 s, 3H each, SiCH₃), 0.79 (s, 9H, SiC(CH₃)₃), 1.16 (d, *J* = 6.2 Hz, 3H, H-4), 2.33 (dd, *J* = 15.9, 3.4 Hz, 1H, H-2), 2.47 (dd, *J* = 15.7, 2.5 Hz, 1H, H-2), 4.26-4.30 (m, H-3), 9.72 (s, 1H, H-1).

¹³C NMR (100 MHz, CDCl₃): δ = -4.6, -4.0 (SiCH₃), 18.3 (SiC(CH₃)₃), 24.6 (C-4), 26.1 (SiC(CH₃)₃), 53.4 (C-2), 64.9 (C-3), 202.7 (C-1).

IR (neat): $\tilde{\nu}$ = 2930, 1715, 1256 cm⁻¹.

(2*E*,5*S*)-5-[[*tert*-Butyl(dimethyl)silyl]oxy]-2-hexen-1-ol (**81**)

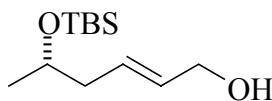

To a solution of ester **62** (17.6 g, 68 mmol) in CH₂Cl₂ (150 mL) was added DIBAL-H (1.0 M in hexane, 150 mL, 150 mmol) dropwise at -78 °C. After being stirred for 1.5 h at -78 °C, the temperature was raised to -30 °C, methanol (2 mL) was added, and the mixture allowed to reach 0 °C. Then a saturated solution of potassium sodium tartarate (100 mL) was added. The layers were separated and the aqueous layer extracted with Et₂O (3 x 25 mL). The combined organic layers were washed with brine, dried (MgSO₄), filtered and concentrated. The crude product was purified by flash chromatography (petroleum ether/Et₂O, 4:1) to yield 15.0 g (96%) of alcohol **81** as a colorless oil. TLC (petroleum ether/ethyl acetate, 4:1): R_f = 0.49; [α]_D²⁶ +6.04 (c 0.98, CHCl₃).

¹H NMR (400 MHz, CDCl₃): δ = 0.02, 0.02 (2 s, 3H each, SiCH₃), 0.86 (s, 9H, SiC(CH₃)₃), 1.11 (d, *J* = 6.1 Hz, 3H, H-6), 1.62 (s, br, 1H, OH), 2.09-2.21 (m, 2H, H-4), 3.77-3.85 (m, 1H, H-5), 4.07 (d, *J* = 4.0 Hz, 1H, H-1), 5.63-5.67 (m, 2H, H-3, H-2).

¹³C NMR (100 MHz, CDCl₃): δ = -4.6, -4.6 (SiCH₃), 18.1 (SiC(CH₃)₃), 23.4 (C-6), 25.8 (SiC(CH₃)₃), 42.5 (C-4), 63.7 (C-1), 68.4 (C-5), 129.6 (C-2), 131.2 (C-3).

IR (neat): $\tilde{\nu}$ = 3343 (br), 2956, 2929, 1255 cm⁻¹.

[(1*S*,2*R*)-2-((2*S*)-2-{*tert*-Butyl(dimethyl)silyl]oxy}propyl)cyclopropyl]methyl methanesulfonate (82**)**



Triethylamine (6.3 mL, 45 mmol) and methanesulfonyl chloride (1.75 mL, 22.5 mmol) were added to a cooled (0 °C) solution of the alcohol **61** (3.67 g, 15 mmol) in dry CH₂Cl₂ (100 mL) under a nitrogen atmosphere. After being stirred for 30 min at 0 °C, the mixture was diluted with ether, washed with H₂O and brine. The organic layer was dried (MgSO₄), filtered, and concentrated to give **82** as a colorless oil (4.84 g). The residue was used for the next reaction without further purification. TLC (petroleum ether/ethyl acetate, 4:1): R_f = 0.40; [α]_D²³ +7.89 (*c* 0.93, CHCl₃).

¹H NMR (400 MHz, CDCl₃): δ = 0.03, 0.04 (2 s, 3H each, SiCH₃), 0.45-0.56 (m, 2H, cyclopropane CH₂), 0.87 (s, 9H, SiC(CH₃)₃), 0.95-1.02 (m, 1H, H-2'), 1.14 (d, *J* = 6.0 Hz, 3H, CH₃), 1.15-1.19 (m, 1H, CH₂), 1.24 (s, br, 1H, H-1'), 1.56-1.62 (m, 1H, CH₂), 2.99 (s, 3H, Ms CH₃), 3.85 (q, *J* = 6.1 Hz, 1H, CHOR), 4.01-4.14 (m, 2H, CH₂OMs).

¹³C NMR (100 MHz, CDCl₃): δ = -4.7, -4.5 (SiCH₃), 11.0 (cyclopropane CH₂), 14.9 (cyclopropane C-2'), 17.4 (cyclopropane C-1'), 18.1 (SiC(CH₃)₃), 23.6 (CH₃), 25.9 (Si(CH₃)₃), 37.9 (Ms CH₃), 43.2 (CH₂), 68.3 (CHOR), 74.7 (CH₂OMs).

IR (neat): $\tilde{\nu}$ = 2956, 2930, 2858, 1255 cm⁻¹.

HRMS: calcd. for C₁₄H₃₀O₄SSiNa [M + Na]⁺ 345.15263, found 345.15299.

(1*R*,2*R*)-1-[(2*S*)-2-{*tert*-Butyl(dimethyl)silyl]oxy}-propyl]-2-(iodomethyl)cyclopropane (83**)**

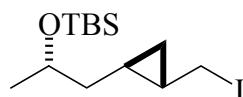

A solution of the crude sulfonate **82** (4.84 g, 15 mmol) in dry acetone (100 mL) was treated with sodium iodide (4.84 g, 135 mmol) at 0 °C. After being stirred for 3 h at room temperature, the mixture was diluted with petroleum ether (50 mL) and washed with

H₂O (50 mL). The aqueous phase was extracted with Et₂O (3 x 30 mL). The combined organic layers were washed with brine, dried (MgSO₄), filtered and concentrated. The residue was purified by flash chromatography (petroleum ether/Et₂O, 8:1) to afford the iodide **83** as a pale yellow oil (5.11 g, 96% from **61**) which is used immediately for the next step. TLC (petroleum ether/ethyl acetate, 60:1): R_f = 0.44.

¹H NMR (400 MHz, CDCl₃): δ = 0.04, 0.04 (2 s, 3H each, SiCH₃), 0.42-0.46 (m, 1H, cyclopropane CH₂), 0.59-0.63 (m, 1H, cyclopropane CH₂), 0.68-0.76 (m, 1H, cyclopropane CH), 0.87 (s, 9H, SiC(CH₃)₃), 1.03-1.10 (m, 1H, CH₂), 1.15 (d, *J* = 6.0 Hz, 3H, CH₃), 1.24 (s, br, 1H, cyclopropane CH), 1.47-1.53 (m, 1H, CH₂), 3.09-3.19 (m, 2H, CH₂I), 3.85 (q, *J* = 6.1 Hz, 1H, CHOR).

¹³C NMR (100 MHz, CDCl₃): δ = -4.7, -4.5 (SiCH₃), 13.7 (cyclopropane CH₂), 17.9 (CH₂I), 18.1 (SiC(CH₃)₃), 22.1 (cyclopropane C-2'), 23.3 (cyclopropane C-1'), 23.6 (CH₃), 25.9 (SiC(CH₃)₃), 43.8 (CH₂), 68.4 (CHOR).

IR (neat): $\tilde{\nu}$ = 2956, 2928, 2857 cm⁻¹.

HRMS: calcd. for C₁₃H₂₇OISiNa [M + Na]⁺ 377.07681, found 377.07665.

3-[(1*R*,3*S*)-3-[[*tert*-Butyl(dimethyl)silyl]oxy]-1-methylbutyl]-1,2,4-trioxolane (**89**)

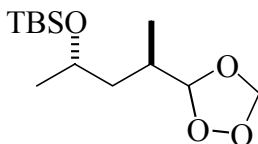

Ozone was passed through the solution of alkene **60** (6.85 g, 30.0 mmol) in 100 mL of CH₂Cl₂ (0.3 M) at -78 °C until a deep blue color appeared (2 h). The solution was kept at -78 °C and nitrogen gas was passed through it until the color faded (2 h). The solution was used for the next reaction without further purification. For analytical purposes, a sample was carefully concentrated in vacuo. TLC (petroleum ether/ethyl acetate, 4:1): R_f = 0.40.

¹H NMR (400 MHz, CDCl₃): δ = 0.04 (s, 6H, SiCH₃), 0.05 (s, 6H, SiCH₃), 0.87 (s, 9H, SiC(CH₃)₃), 0.97 (dd, *J* = 6.8, 2.3 Hz, 3H, CH₃), 1.14 (d, *J* = 6.1 Hz, 3H, H-4'), 1.32-1.71 (m, 1H, H-2'), 2.04-2.12 (m, 1H, H-2'), 3.86-3.96 (m, 1H, H-1'), 4.93-4.96 (m, 1H, H-3), 5.00 (d, *J* = 3.8 Hz, 1H, H-5), 5.20 (d, *J* = 2.0 Hz, 1H, H-5).^a

^{13}C NMR (100 MHz, CDCl_3): $\delta = -4.9, -4.1$ ($\text{Si}\underline{\text{C}}\text{H}_3$), 13.5 and 13.7 (CH_3), 18.2 ($\text{Si}\underline{\text{C}}(\text{CH}_3)_3$), 24.4 (C-4'), 25.8 ($\text{SiC}(\underline{\text{C}}\text{H}_3)_3$), 31.3 and 31.6 (C-1'), 41.2 and 41.4 (C-2'), 65.6 (C-3), 94.2 and 94.3 (C-5), 106.8 (C-3).^a

Note: a) Some peaks are doubled since **60** is a mixture of diastereomers.

IR (neat): $\tilde{\nu} = 2957, 2930, 2886, 2858, 1463, 1255, 1084$.

HRMS: calcd. for $\text{C}_{13}\text{H}_{28}\text{O}_4\text{SiNa}$ [$\text{M} + \text{Na}$]⁺ 299.16491, found 299.16494.

Methyl (2*E*,4*R*,6*S*)-6-[[*tert*-Butyl(dimethyl)silyl]oxy]-2,4-dimethylhept-2-enoate (**91**)

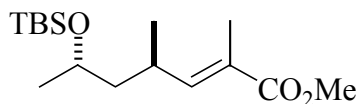

Methyl methacrylate (**92**) (222 μL 2.0 mmol) and alkene **60** (46 mg 0.2 mmol) were added to solution of Grubbs catalyst **69** (8 mg, 10^{-2} mmol, 5 mol%) in CH_2Cl_2 (1 mL). The mixture was refluxed at 40 $^\circ\text{C}$ under nitrogen for 20 h. The reaction mixture was then concentrated to about 0.5 mL and purified directly by flash chromatography (petroleum ether/ Et_2O , 20:1) to afford the enoate **91** as a colorless oil (42 mg, 73%, only trans was detected by ^1H NMR spectroscopy). TLC (petroleum ether/ethyl acetate, 20:1): $R_f = 0.52$; $[\alpha]_D^{26} -6.98$ (c 1.0, CH_2Cl_2).

^1H NMR (400 MHz, CDCl_3): $\delta = 0.04$ (s, 6H, SiCH_3), 0.87 (s, 9H, $\text{SiC}(\text{CH}_3)_3$), 0.98 (d, $J = 6.6$ Hz, 3H, CH_3), 1.10 (d, $J = 6.0$ Hz, 3H, H-7), 1.32-1.38 (m, 1H, H-5), 1.46-1.53 (m, 1H, H-5), 1.83 (s, 3H, CH_3), 2.58-2.69 (m, 1H, H-4), 3.72 (s, 3H, OCH_3), 3.75-3.79 (m, 1H, H-6), 6.57 (d, $J = 9.9$ Hz, 1H, H-3).

^{13}C NMR (100 MHz, CDCl_3): $\delta = -4.8, -4.2$ ($\text{Si}\underline{\text{C}}\text{H}_3$), 12.4 ($\underline{\text{C}}\text{H}_3\text{C}=\text{CH}$), 18.0 ($\text{Si}\underline{\text{C}}(\text{CH}_3)_3$), 19.5 ($\underline{\text{C}}\text{H}_3\text{CH}$), 24.0 (C-7), 25.8 ($\text{SiC}(\underline{\text{C}}\text{H}_3)_3$), 29.7 (C-4), 46.5 (C-5), 51.7 (OCH_3), 66.2 (C-6), 125.7 (C-2), 148.2 (C-3), 168.9 (C-1).

IR (neat): $\tilde{\nu} = 2956, 2929, 2857, 1719, 1256$ cm^{-1} .

HRMS: calcd. for $\text{C}_{16}\text{H}_{32}\text{O}_3\text{SiNa}$ 323.20129, found 323.20125.

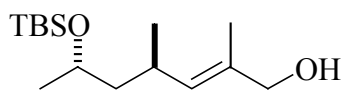
(2E,4R,6S)-6-[[tert-Butyl(dimethyl)silyl]oxy]-2,4-dimethylhept-2-en-1-ol (93)

A solution of ester **91** (990 mg, 3.3 mmol) in CH₂Cl₂ (100 mL) was treated with DIBAL-H (1.0 M in hexane, 7.3 mL, 7.3 mmol) in a dropwise fashion at -78 °C. After stirring for 1.5 h at -78 °C, the temperature was raised to -30 °C, methanol (0.5 mL) was added, and the mixture warmed up to 0 °C. The other workup manipulations were carried out as described for the synthesis of **81**. The crude product **93** was used without further purification; yield 898 mg (100%), colorless oil. TLC (petroleum ether/ethyl acetate, 6:1): R_f = 0.50; [α]_D²⁵ -1.94 (c 0.25, CHCl₃) {Ref.¹⁷ [α]_D²⁴ -1.6 (c 0.91, CHCl₃)}.

¹H NMR (400 MHz, CDCl₃): δ = 0.04 (s, 6H, SiCH₃), 0.88 (s, 9H, SiC(CH₃)₃), 0.93 (d, J = 6.6 Hz, 3H, CH₃), 1.10 (d, J = 6.0 Hz, 3H, CH₃), 1.26 (s, br, 1H, OH), 1.26-1.32 (m, 1H, H-5), 1.41-1.48 (m, 1H, H-5), 1.66 (s, 3H, CH₃), 2.47-2.54 (m, 1H, H-4), 3.73-3.81 (m, 1H, H-6), 3.97 (s, 2H, CH₂OH), 6.57 (d, J = 9.9 Hz, 1H, H-3).

¹³C NMR (100 MHz, CDCl₃): δ = -4.7, -4.2 (SiCH₃), 13.7 (CH₃C=CH), 18.1 (SiC(CH₃)₃), 20.5 (CH₃CH), 24.0 (C-7), 25.9 (SiC(CH₃)₃), 28.6 (C-4), 47.5 (C-5), 66.5 (C-6), 69.0 (C-1), 132.8 (C-3), 133.0 (C-2).

IR (neat): $\tilde{\nu}$ = 3336 (br), 2957, 2928, 2857, 1255 cm⁻¹.

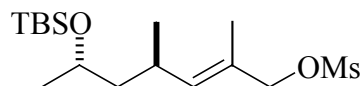
(2E,4R,6S)-6-[[tert-Butyl(dimethyl)silyl]oxy]-2,4-dimethylhept-2-enyl methanesulfonate (94)

Triethylamine (340 μL, 1.25 mmol) and methanesulfonyl chloride (97 μL, 1.25 mmol) were added to a cooled (0 °C) solution of the alcohol **93** (221 mg, 0.81 mmol) in dry CH₂Cl₂ (5 mL) under a nitrogen atmosphere. After being stirred for 30 min at 0 °C, the mixture was diluted with Et₂O (10 mL), washed with H₂O, brine, dried (MgSO₄), filtered and concentrated in vacuo providing 275 mg (97%) of the crude mesylate **94** as a colorless

oil. The crude product, containing around 10% of the corresponding chloride was used for the next step without further purification. TLC (petroleum ether/ethyl acetate, 8:1): $R_f = 0.54$; $[\alpha]_D^{24} -1.04$ (c 1.00, CHCl_3).

$^1\text{H NMR}$ (400 MHz, CDCl_3): $\delta = 0.05$ (s, 6H, SiCH_3), 0.89 (s, 9H, $\text{SiC}(\text{CH}_3)_3$), 0.98 (d, $J = 6.8$ Hz, 3H, H-4a), 1.39 (d, $J = 6.3$ Hz, 3H, H-7), 1.50-1.55 (m, 1H, H-5), 1.59 (s, 3H, H-2a), 1.71-1.78 (m, 1H, H-5), 2.46-2.54 (m, 1H, H-4), 2.97 (s, 3H, Ms CH_3), 3.98 (s, 2H, H-1), 4.73-4.78 (m, 1H, H-6), 5.18 (dd, $J = 9.6, 2.6$ Hz, 1H, H-3).

$^{13}\text{C NMR}$ (100 MHz, CDCl_3): $\delta = -5.3$ (SiCH_3), 13.5 ($\text{CH}_3\text{C}=\text{CH}$), 18.4 ($\text{SiC}(\text{CH}_3)_3$), 20.8 (CH_3CH), 21.3 (C-7), 25.9 ($\text{SiC}(\text{CH}_3)_3$), 28.6 (C-4), 38.6 (Ms CH_3), 44.2 (C-5), 68.3 (C-6), 78.8 (C-1), 129.0 (C-3), 134.1 (C-2).

IR (neat): $\tilde{\nu} = 2956, 2930, 1353, 1175$.

HRMS : calcd. for $\text{C}_{16}\text{H}_{34}\text{O}_4\text{SSiNa}$ $[\text{M} + \text{Na}]^+$ 373.18393, found 373.18381.

(4R)-4-Benzyl-3-((2S,4E,6R,8S)-8-[[*tert*-butyl(dimethyl)silyl]oxy]-2,4,6-trimethylnon-4-enoyl)-1,3-oxazolidin-2-one (96)

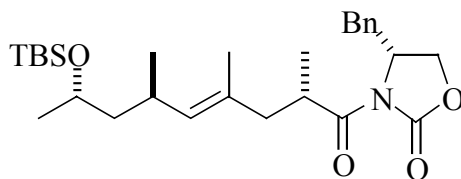

To a solution of propionyl-1,3-oxazolidin-2-one **75** (173 mg, 0.74 mmol) in THF (20 mL) was added sodium hexamethyldisilazide (0.4 mL, 2.0 M in THF, 0.8 mmol) at -78 °C. The solution was then stirred at -78 °C for 2 h before a solution of iodide **59** (264 mg, 0.64 mmol) in THF (3 mL) was added. The reaction was allowed to proceed at -78 °C for 15 h, then the mixture was allowed to reach 0 °C. Thereafter, the mixture was partitioned between saturated NH_4Cl (10 mL) and Et_2O (10 mL). The layers were separated and the aqueous layer was extracted with Et_2O (2 x 50 mL). The combined organic extracts were dried (MgSO_4), filtered, and concentrated to yield a white amorphous solid. The crude product was purified by flash chromatography (petroleum ether/ Et_2O , 6:1) to afford the alkylation product **96** as a sticky colorless oil (190 mg, 61%) and recovered iodide **59** (24%). TLC petroleum ether/ethyl acetate, 6:1): $R_f = 0.54$; $[\alpha]_D^{25} -30.0$ (c 0.94, CHCl_3) {Ref.¹⁷ $[\alpha]_D^{24} -35.2$ (c 0.94, CHCl_3)}

$^1\text{H NMR}$ (400 MHz, CDCl_3): $\delta = 0.06$ (s, 6H, SiCH_3), 0.89 (d, $J = 6.6$ Hz, 3H, CH_3), 0.90 (s, 9H, $\text{SiC}(\text{CH}_3)_3$), 1.11 (d, $J = 5.8$ Hz, 3H, H-9'), 1.12 (d, $J = 6.8$ Hz, 3H, CH_3), 1.27-1.34

(m, 1H, H-7'), 1.43-1.50 (m, 1H, H-7'), 1.68 (s, 3H, CH₃), 1.97-2.03 (m, 1H, H-3'), 2.46-2.50 (m, 1H, H-6'), 2.52 (m, 1H, H-3'), 2.69-2.75 (m, 1H, benzylic H), 3.26-3.30 (m, 1H, benzylic H), 3.75-3.82 (m, 1H, H-8'), 3.92-4.01 (m, 1H, H-2'), 4.13-4.20 (m, 2H, H-5), 4.66-4.72 (m, 1H, H-4), 5.03 (d, $J = 9.4$ Hz, 1H, H-5'), 7.21-7.35 (m, 5H, aromatic H).

¹³C NMR (100 MHz, CDCl₃): $\delta = -4.9, -4.5$ (SiC(CH₃)), 15.4 (C-4a'), 16.0 (C-2a'), 18.0 (SiC(CH₃)₃), 20.8 (C-6a'), 23.6 (C-9'), 25.8 (SiC(CH₃)₃), 29.0 (C-6'), 35.4 (C-2'), 38.0 (CH₂C₆H₅), 43.9 (C-3'), 47.5 (C-7'), 55.2 (C-4), 66.6 (C-5), 68.5 (C-8'), 127.2, 128.8, 129.3 (aromatic C), 130.1 (C-4'), 134.4 (C-5'), 135.3 (aromatic C), 153.0 (C-2), 177.0 (C-1').

IR (neat): $\tilde{\nu} = 2956, 2929, 1783, 1387$ cm⁻¹.

5.3 Alternative Approach to 8-Hydroxy Acid and Derivatives

(S)-Ethyl 3-hydroxyheptanoate (108)

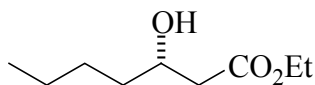

A. [(S)-2,2'-Bis(diphenylphosphino)-1,1'-binaphthyl]ruthenium(II) complex.

A Schlenk tube was charged with [RuCl₂(benzene)₂] (11 mg, 2.2 x 10⁻² mmol) and (S)-BINAP (**107**) (28 mg, 4.5 x 10⁻² mmol). DMF (1 mL) was introduced with a hypodermic syringe and the suspension was stirred at 100 °C for 10 min, giving a clear reddish brown solution. The reaction mixture was cooled and concentrated at 1 mm at 50 °C with vigorous stirring and then at 0.1 mm for 1 h to give (S)-BINAP-Ru(II) complex as a reddish brown solid. This complex was used as the hydrogenation catalyst.

B. Hydrogenation of ethyl 3-oxoheptanoate (**106**)

The Schlenk tube was charged with ethyl 3-oxoheptanoate (**106**) (17.2 g, 100 mol) and methanol (17 mL). To this mixture was added a solution of the in situ prepared (S)-BINAP-Ru(II) complex (from A) in methanol (2 mL) via hypodermic syringe, and the flask was rinsed with MeOH (2 mL). The resulting yellowish orange solution was transferred by cannula to an autoclave, and the flask was rinsed with MeOH (2 x 5 mL).

The autoclave was equipped with a gas inlet tube, a septa-covered stop valve, and pressure gauge. The gas inlet tube was attached to a hydrogen source. Hydrogen was introduced into the reaction vessel while the internal temperature was 95 °C. The pressure was carefully released to 1 atm by opening the stop valve. This procedure was repeated three times, and finally hydrogen was pressurized to 5.75 bar. The solution was stirred at 95 °C for 23 h during which time the hydrogen cylinder was kept connected. After the main valve of the hydrogen cylinder had been closed, the reaction mixture was allowed to cool to room temperature, excess hydrogen was carefully bled off, and the apparatus was disassembled. The solvent was removed from the reaction mixture by a rotary evaporator. The crude product was purified by distillation to give a colorless oil 15.8 g (91% yield) of **108** in 93% ee as a fraction boiling at 55-60 °C, 6×10^{-3} mbar. TLC (petroleum ether/ethyl acetate, 4:1): $R_f = 0.54$.

¹H NMR (400 MHz, CDCl₃): $\delta = 0.86$ (t, $J = 7.0$ Hz, 3H, H-7), 1.23 (t, $J = 7.1$ Hz, 3H, CH₃), 1.26-1.35 (m, 2H, H-6), 1.26-1.44 (m, 2H, H-5), 1.35-1.53 (m, 2H, H-4), 2.32-2.48 (m, 2H, H-2), 3.33 (s, 1H, OH), 3.92-3.98 (m, 2H, H-3), 4.13 (q, $J = 7.1$ Hz, 2H, CH₂).

¹³C NMR (100 MHz, CDCl₃): $\delta = 13.9$ (C-7), 14.1 (CH₃), 22.5 (C-6), 27.6 (C-5), 36.1 (C-4), 41.3 (C-2), 60.6 (CH₂), 67.9 (C-3), 173.0 (C-1).

IR (neat): $\tilde{\nu} = 3369$ (br), 2974, 1710, 1516, 1166 cm⁻¹.

Ethyl (3S)-3-[[*tert*-butyl(dimethyl)silyl]oxy]heptanoate (**109**)

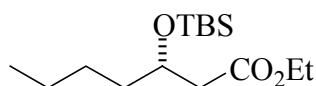

To a stirred solution of alcohol **108** (15.7 g, 90 mmol) in CH₂Cl₂ (100 mL) was added imidazole (12.2 g, 180 mmol) at 0 °C and the mixture stirred for 5 min resulting in a homogeneous solution. Subsequently, *tert*-butyldimethylsilyl chloride (16.3 g, 108 mmol) was added and the whole mixture stirred for 0.5 h at 0 °C and then at room temperature for 23 h. The reaction mixture was diluted with H₂O, the layers were separated and the aqueous layer was extracted with CH₂Cl₂ (4 x 25 mL). The combined organic layers were washed with brine, dried (MgSO₄), filtered, and concentrated. The crude product was

purified by short flash chromatography (petroleum ether/Et₂O, 1:1) to yield **109** as a pale yellow oil (25.4 g, 98%). TLC (petroleum ether/ Et₂O, 20:1): R_f = 0.48.

¹H NMR (400 MHz, CDCl₃): δ = 0.01, 0.04 (2 s, 3H each, SiCH₃), 0.84 (s, 9H, SiC(CH₃)₃), 0.86-0.89 (m, 3H, H-7), 1.24 (t, *J* = 7.1 Hz, 3H, OCH₂CH₃), 1.27-1.29 (m, 4H, H-5, H-6), 1.44-1.49 (m, 2H, H-4), 2.39-2.41 (m, 2H, H-2), 4.07-4.13 (m, 3H, H-3, OCH₂CH₃).

¹³C NMR (100 MHz, CDCl₃): δ = -4.6 (SiCH₃), 14.0 (C-7), 14.2 (OCH₂CH₃), 18.0 (SiC(CH₃)₃), 22.7 (C-6), 25.8 (SiC(CH₃)₃), 27.1 (C-5), 37.3 (C-4), 42.7 (C-2), 60.2 (OCH₂CH₃), 69.5 (C-3), 171.9 (C-1).

IR (neat): $\tilde{\nu}$ = 2958, 2931, 2858, 1739, 1255, 1094 cm⁻¹.

HRMS: calcd. for C₁₅H₃₂O₃SiNa 311.20129, found 311.20135.

(3S)-3-[[*tert*-Butyl(dimethyl)silyl]oxy]heptanal (**110**)

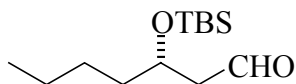

To a solution of ester **109** (4.97 g, 17.2 mmol) in CH₂Cl₂ (140 mL) was added DIBAL-H (1.0 M in hexane, 19 mL, 19 mmol) dropwise at -78 °C. After being stirred for 0.5 h at -78 °C, the temperature was raised to -30 °C. After the reaction was complete by TLC, methanol (0.5 mL) was added, the cooling bath removed, and the mixture warmed to 0 °C. A saturated solution of potassium sodium tartarate was added and the mixture was stirred until it became clear. The layers were separated and the aqueous layer was extracted with CH₂Cl₂ (3 x 25 mL). The combined organic layers were washed with brine, dried (MgSO₄), filtered and concentrated. The residue was purified by short flash chromatography (petroleum ether/Et₂O, 7:1) to yield 2.94 g (70%) of aldehyde **110** as a colorless oil. TLC (petroleum ether/ethyl acetate, 20:1): R_f = 0.45; [α]_D²⁷ +1.90 (*c* 0.18, CH₂Cl₂).

¹H NMR (400 MHz, CDCl₃): δ = 0.04, 0.05 (2 s, 3H each, SiCH₃), 0.85 (s, 9H, SiC(CH₃)₃), 0.88 (t, *J* = 6.8 Hz, 3H, H-7), 1.25-1.33 (m, 4H, H-5, H-6), 1.48-1.54 (m, 2H, H-4), 2.50 (dd, *J* = 5.7, 2.4 Hz, 2H, H-2), 4.13-4.19 (m, 1H, H-3), 9.79 (t, *J* = 2.4 Hz, 1H, H-1).

¹³C NMR (100 MHz, CDCl₃): δ = -4.7, -4.5 (SiCH₃), 14.0 (C-7), 18.0 (SiC(CH₃)₃), 22.6 (C-6), 25.7 (SiC(CH₃)₃), 27.3 (C-5), 37.5 (C-4), 50.8 (C-2), 68.2 (C-3), 202.5 (C-1).

IR (neat): $\tilde{\nu}$ = 2957, 2931, 2858, 1727, 1472, 1255 cm⁻¹.

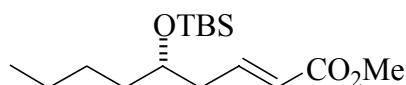
Methyl (2*E*,5*S*)-5-[[*tert*-butyl(dimethyl)silyl]oxy]-2-nonenoate (111)

A mixture of the aldehyde **110** (6.34 g, 25.9 mmol) and carbomethoxymethylene triphenylphosphorane (**80**) (10.4 g, 31.1 mmol) in benzene (60 mL) was refluxed overnight (80 °C, 19 h). The precipitated solids were filtered and washed with cold (0 °C) Et₂O. The filtrate was concentrated and the residue purified by chromatography (petroleum ether/Et₂O, 15:1) to afford the enoate **111** as a pale yellow oil (7.06 g, 86%, *E* isomer was exclusively separated). TLC (petroleum ether/ethyl acetate, 20:1): R_f = 0.43; [α]_D²⁷ -2.69 (*c* 1.03, CH₂Cl₂).

¹H NMR (400 MHz, CDCl₃): δ = 0.02, 0.02 (2 s, 3H each, SiCH₃), 0.84-0.89 (m, 3H, H-9), 0.86 (s, 9H, SiC(CH₃)₃), 1.25-1.32 (m, 4H, H-7, H-8), 1.39-1.44 (m, 2H, H-6), 2.29-2.35 (m, 2H, H-4), 3.71 (s, 3H, OCH₃), 3.73-3.77 (m, 1H, H-5), 5.82 (d, *J* = 15.7 Hz, 1H, H-2), 6.96 (dt, *J* = 15.7, 7.2 Hz, 1H, H-3).

¹³C NMR (100 MHz, CDCl₃): δ = -4.6 (SiCH₃), 14.1 (C-9), 18.1 (SiC(CH₃)₃), 22.7 (C-8), 25.8 (SiC(CH₃)₃), 27.5 (C-7), 36.9 (C-6), 46.2 (C-4), 51.3 (OCH₃), 71.2 (C-5), 122.7 (C-2), 146.4 (C-3), 166.9 (C-1).

IR (neat): $\tilde{\nu}$ = 2956, 2931, 2858, 1729, 1659, 1257 cm⁻¹.

HRMS: calcd. for C₁₆H₃₂O₃SiNa 323.21129, found 323.20127.

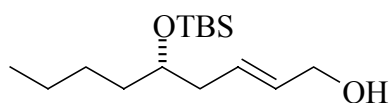
(2E,5S)-5-[[*tert*-Butyl(dimethyl)silyl]oxy]-2-nonen-1-ol (112)

To a solution of ester **111** (2.49 g, 8.28 mmol) in CH₂Cl₂ (20 mL) was added DIBAL-H (1.0 M in hexane, 18 mL, 18 mmol) dropwise at -78 °C. After being stirred for 0.5 h at -78 °C, the temperature was raised to -30 °C. After the reaction was complete by TLC, methanol (1 mL) was added, and the mixture allowed to reach 0 °C. Then a saturated solution of potassium sodium tartarate (100 mL) was added. The layers were separated and the aqueous layer was extracted with CH₂Cl₂ (3 x 10 mL). The combined organic layers were washed with brine, dried (MgSO₄), filtered and concentrated. The crude product was purified by flash chromatography (petroleum ether/Et₂O, 1:1) to yield 2.17 g (96%) of alcohol **112** as a colorless oil. TLC (petroleum ether/ethyl acetate, 6:1): R_f = 0.40; [α]_D²⁷ - 6.46 (*c* 1.06, CH₂Cl₂).

¹H NMR (400 MHz, CDCl₃): δ = 0.02, (s, 6H, SiCH₃), 0.85-0.89 (m, 3H, H-7, H-9), 0.86 (s, 9H, SiC(CH₃)₃), 1.24-1.32 (m, 4H, H-7, H-8), 1.38-1.43 (m, 2H, H-6), 1.62 (s, br, 1H, OH), 2.14-2.22 (m, 2H, H-4), 3.63-3.68 (m, 1H, H-5), 4.08 (d, *J* = 4.6 Hz, 2H, H-1), 5.63-5.68 (m, 2H, H-3, H-2).

¹³C NMR (100 MHz, CDCl₃): δ = -4.6 (SiCH₃), 14.1 (C-9), 18.1 (SiC(CH₃)₃), 22.8 (C-8), 25.9 (SiC(CH₃)₃), 27.6 (C-7), 36.5 (C-6), 40.1 (C-4), 63.7 (C-1), 72.0 (C-5), 129.6 (C-2), 131.1 (C-3).

IR (neat): $\tilde{\nu}$ = 3322 (br), 2956, 2930, 2858, 1255 cm⁻¹.

HRMS: calcd. for C₁₅H₃₂O₃SiNa 295.20638, found 295.20630.

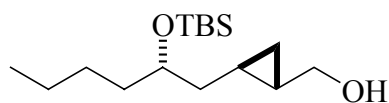
[(1S,2R)-2-((2S)-2-[[*tert*-Butyl(dimethyl)silyl]oxy]hexyl)cyclopropyl]methanol (113)

To a solution of CH₂Cl₂ (100 mL) and 1,2-dimethoxyethane (DME) (2.6 mL, 25 mmol) was added a solution of diethylzinc (0.88 M in hexane, 28 mL, 25 mmol) at -10 °C followed by the dropwise addition of CH₂I₂ (4.0 mL, 50 mmol) over 15-20 min while

maintaining the internal temperature between -8 and -12 °C. After complete addition, the resulting clear solution was stirred for 10 min at -10 °C before a solution of dioxaborolane ligand **67** (4.05 g, 15 mmol) in CH₂Cl₂ (15 mL, 1.0 M) was added via cannula over a 15-20 min period while maintaining the internal temperature below -5 °C. This was followed by the dropwise addition of alcohol **112** (3.41 g, 12.5 mmol), dissolved in CH₂Cl₂ (15 mL) while maintaining the internal temperature below -5 °C. After being stirred for 0.5 h at -10 °C, the mixture was allowed to reach room temperature and stirred for 19 h. The reaction was quenched with saturated NH₄Cl solution (10 mL) and 10% of HCl (40 mL) and the mixture was extracted with Et₂O (3 x 25 mL). The combined organic layers were added to a mixture of 2 N NaOH (60 mL) and H₂O₂ (30%, 10 mL). The biphasic solution was stirred for 5 min and then the layers were separated. The organic phase was washed with 10% of HCl (50 mL), Na₂SO₃ (50 mL), NaHCO₃ (50 mL), and brine (50 mL). After drying (MgSO₄), filtration and concentration of the organic layer under reduced pressure, the crude product was purified by flash chromatography (petroleum ether/Et₂O, 6:1) to afford **113** as a colorless oil (3.20 g, 89%, >95% de). TLC (petroleum ether/ethyl acetate, 4:1): R_f = 0.45; [α]_D²⁷ +9.64 (c 1.10, CH₂Cl₂).

¹H NMR (400 MHz, CDCl₃): δ = 0.01, 0.02 (2 s, 3 H each, SiCH₃), 0.25-0.30 (m, 1H, cyclopropane CH₂), 0.32-0.37 (m, 1H, cyclopropane CH₂), 0.63-0.70 (m, 1H, H-2'), 0.86 (s, 9H, SiC(CH₃)₃), 0.86-0.87 (m, 2H, H-1'), 1.23-1.30 (m, 5H, H-1'', H-4'', H-5''), 1.41-1.55 (m, 3H, H-1'', H-3''), 1.99 (s, br, 1H, OH), 3.33-3.38 (m, 1H, CH₂OH), 3.45-3.49 (m, 1H, CH₂OH), 3.57-3.61 (m, 1H, CHOR).

¹³C NMR (100 MHz, CDCl₃): δ = -4.6 (SiCH₃), 9.9 (cyclopropane CH₂), 13.4 (cyclopropane C-2'), 14.1 (CH₃), 18.1 (SiC(CH₃)₃), 21.2 (cyclopropane C-1'), 22.8 (C-5''), 25.9 (SiC(CH₃)₃), 27.5 (C-4''), 36.6 (C-3''), 41.0 (C-1''), 67.0 (CH₂OH), 72.4 (CHOR).

IR (neat): $\tilde{\nu}$ = 3351 (br), 2937, 2866, 1462, 1373, 1254, 1053 cm⁻¹.

HRMS: calcd. for C₁₆H₃₄O₂SiNa 309.22203, found 309.22201.

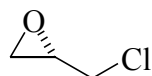
(S)-Epichlorohydrin ((S)-121)**A. [(R,R)-N,N'-Bis(3,5-di-*tert*-butylsalicylidene)-1,2-cyclohexanediaminato(2-)]cobalt(II)**

A solution of cobalt(II) acetate tetrahydrate (1.49 g, 6.0 mmol) in MeOH (20 mL) was added to a solution of ligand [(R,R)-N,N'-bis(3,5-di-*tert*-butylsalicylidene)-1,2-cyclohexanediamine ((R,R)-**119**) (2.73 g, 5 mmol) in CH₂Cl₂ (20 mL) via cannula, and the flask was rinsed with MeOH (5 mL). A brick-red solid began to precipitate before addition was complete. The mixture was allowed to stir for 15 min at room temperature and then 30 min at 0 °C. Precipitated solids were filtered and rinsed with cold (0 °C) MeOH (2 x 10 mL). The red solid was dried in vacuo to yield the desired product as a red amorphous solid (2.95 g, 49 mmol, 98%). The catalyst was used for the next step without further purification.

B. Hydrolytic kinetic resolution of epichlorohydrin ((±)-121)

A solution of the catalyst [(R,R)-N,N'-bis(3,5-di-*tert*-butylsalicylidene)-1,2-cyclohexanediaminato(2-)]cobalt(II) (from A) (1.2 g, 2 mmol, 0.005 equiv) in CH₂Cl₂ (20 mL) was treated with acetic acid (1.2 mL). The crude catalyst residue obtained after concentration was treated with with (±)-epichlorohydrin (31 mL, 400 mmol) in THF (4 mL). The solution was cooled to -30 °C, and then treated with H₂O (4 mL, 220 mmol, 0.55 equiv) and the temperature was raised up to 0 °C and stirring continued at that temperature for 16 h. The crude product was purified by distillation at 25 °C (0.1 mbar) into a cooled (-30 °C) receiving flask, to give a solution of (*S*)-epichlorohydrin ((*S*)-**121**) in THF (amount of product calculated by ¹H-NMR, as 12.7 g, 137 mmol, 35% yield, >99% ee).

¹H NMR (400 MHz, CDCl₃): δ = 2.66-2.68 (m, 1H, H-3), 2.87-2.89 (m, 1H, H-3), 3.21-3.25 (m, 1H, H-2), 3.56 (d, *J* = 5.3 Hz, 1H, H-1').

¹³C NMR (100 MHz, CDCl₃): δ = 45.0 (C-1'), 46.9 (C-3), 51.2 (C-2).

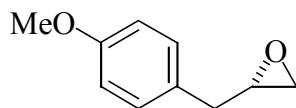
(2S)-2-(4-Methoxybenzyl)oxirane ((S)-123)

A solution of *p*-anisolbromide (0.35 mL, 2.75 mmol) in dry THF (5 mL) was treated with *t*-BuLi (1.5 M in pentane, 5 mL, 7.5 mmol) at 0 °C. The resulting mixture was stirred at 0 °C for 5 min, then the temperature was raised to room temperature. The resultant solution was stirred at room temperature for 30 min, before a solution of (*S*)-epichlorohydrin ((*S*)-**121**) (0.2 mL, 2.5 mmol) in THF (0.3 mL) was added at -78 °C. The solution was allowed to warm to room temperature and stirred for 2 h. The reaction was quenched with saturated NH₄Cl solution (5 mL). The layers were separated and the aqueous layer was extracted with Et₂O (3 x 5 mL). The combined organic layers were washed with brine, dried (MgSO₄), filtered, and concentrated. The crude product was purified by distillation to give a colorless oil 279 mg (68% yield) of (*S*)-**123** as a fraction boiling at 74-82 °C, 6 x 10⁻³ mbar. TLC (petroleum ether/ethyl acetate, 4:1): R_f = 0.56; [α]_D²⁵ -7.76 (*c* 1.06, CH₂Cl₂). {Ref.¹⁴⁶ [α]_D²⁰ +0.9 (*c* 1.0, CHCl₃)}.

¹H NMR (400 MHz, CDCl₃): δ = 2.51-2.53 (m, 1H, H-3), 2.73-2.78 (m, 1H, H-1'), 2.76-2.78 (m, 1H, H-3), 2.84-2.89 (m, 1H, H-1'), 3.09-3.13 (m, 1H, H-2), 3.79 (s, 3H, OCH₃), 6.85 (d, *J* = 8.6 Hz, 2H, aromatic H), 7.16 (d, *J* = 8.6 Hz, 2H, aromatic H).

¹³C NMR (100 MHz, CDCl₃): δ = 37.8 (C-1'), 46.8 (C-3), 52.6 (C-2), 55.2 (OCH₃), 113.9, 129.1, 130.0, 158.4 (aromatic C).

IR (neat) $\tilde{\nu}$ = 3046, 2995, 2836, 1613, 1513, 1247, 1178, 1035.

(2*S*)-2-[[*tert*-Butyl(dimethyl)silyl]oxy]-1-(1,3-dithian-2-yl)-3-(4-methoxyphenyl)propane (126**)**

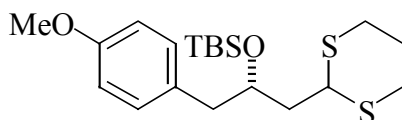

A solution of *tert*-butyl(1,3-dithian-2-yl)dimethylsilane (**124**)¹⁰⁵ (13.4 g, 57 mmol) in Et₂O (100 mL) was cooled to -78 °C, and *t*-BuLi (1.5 M in pentane, 40 mL, 60 mmol) was added dropwise over 15 min. The resultant solution was stirred at -45 °C for 15 min before a solution of (2*S*)-2-(4-methoxybenzyl)oxirane ((*S*)-**123**) (8.88 g, 54 mmol) in Et₂O (10 mL) was added at -78 °C. The solution was allowed to stir for 15 min at -78 °C and then 1.5 h at -25 °C. At this point HMPA (3.8 mL, 22 mmol) was added at -78 °C and then the cooling bath was removed. The reaction was stirred at room temperature for 14 h as a dark red color developed. After TLC indicated completion of the silyl rearrangement, the reaction was quenched with saturated NH₄Cl solution (50 mL) at 0 °C. The aqueous layer was extracted with Et₂O (3 x 50 mL). The combined organic layers were washed with brine, dried (MgSO₄), filtered, and concentrated. The residue was purified by chromatography (petroleum ether/Et₂O, 11:1) to afford the dithiane **126** as a pale yellow oil (16.1 g, 75% yield) TLC (petroleum ether/ethyl acetate, 16:1): R_f = 0.43; [α]_D²⁵ +24.6 (*c* 1.08, CH₂Cl₂).

¹H NMR (400 MHz, CDCl₃): δ = -0.07, 0.07 (2 s, 3H each, SiCH₃), 0.88 (s, 9H, SiC(CH₃)₃), 1.75-1.87 (m, 3H, 2 x H-1', H-5), 2.04-2.11 (m, 1H, H-5), 2.63-2.89 (m, 6H, H-3', H-4, H-6), 3.77 (s, 3H, CH₃), 4.06-4.14 (m, 2H, H-2, H-2'), 6.80 (d, *J* = 8.6 Hz, 2H, aromatic H), 7.07 (d, *J* = 8.6 Hz, 2H, aromatic H).

¹³C NMR (100 MHz, CDCl₃): δ = -4.8, -4.7 (SiCH₃), 18.0 (SiC(CH₃)₃), 25.9 (3C, TBS-C(CH₃)₃), 26.0 (C-5), 29.9 (C-6), 30.5 (C-4), 42.2 (C-1'), 43.4 (C-3'), 44.0 (C-2'), 55.2 (OCH₃), 70.0 (C-2'), 113.6, 130.2, 130.5, 158.1 (aromatic C).

IR (neat) $\tilde{\nu}$ = 2930, 2855, 1611, 1512, 1247, 1178, 1083, 1038.

HRMS: calcd. for C₂₀H₃₄O₂S₂SiNa 421.16617, found 421.16644.

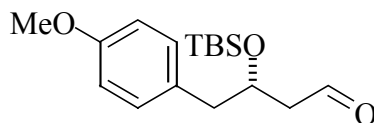
(3S)-3-[[*tert*-Butyl(dimethyl)silyloxy]-4-(4-methoxyphenyl)butanal (127)

A mixture of dithiane (**126**) (7.98 g, 20 mmol), CaCO₃ (4.91 g, 49 mmol), CH₃I (50 mL) in CH₃CN (500 mL) and H₂O (220 mL) was stirred with protection from light for 23 h at room temperature. The mixture was extracted with ethyl acetate (2 x 300 mL). The combined organic layers were washed with brine, dried (MgSO₄), filtered and concentrated. The residue was purified by filtration through a short column of celite. The filter celite was washed with ethyl acetate and the combined filtrate was concentrated to yield aldehyde **127** (5.76 g, 93%) as a pale yellow oil. The product was used for the next step without further purification. TLC (petroleum ether/ethyl acetate, 8:1): R_f = 0.56; [α]_D²⁴ -6.74 (c 1.01, CH₂Cl₂).

¹H NMR (400 MHz, CDCl₃): δ = -0.08, 0.01 (2 s, 3H each, SiCH₃), 0.85 (s, 9H, SiC(CH₃)₃), 2.48 (dd, *J* = 5.7, 2.4 Hz, 2H, H-2), 2.68-2.73 (s, 1H, H-4), 2.78-2.83 (m, 1H, H-4), 3.77 (s, 3H, OCH₃), 4.29-4.35 (m, 1H, H-3), 6.82 (d, *J* = 8.6 Hz, 2H, aromatic H), 7.07 (d, *J* = 8.6 Hz, 2H, aromatic H), 9.75 (t, *J* = 2.4 Hz, 2H, H-1).

¹³C NMR (100 MHz, CDCl₃): δ = -5.0, -4.8 (SiCH₃), 17.9 (SiC(CH₃)₃), 25.7 (SiC(CH₃)₃), 43.5 (C-4), 50.3 (C-2), 55.2 (OCH₃), 69.7 (C-3), 113.8, 129.8, 130.6, 158.3 (aromatic C), 202.1 (C-1).

IR (neat) $\tilde{\nu}$ = 2954, 2930, 2856, 1726, 1613, 1513, 1249, 1101.

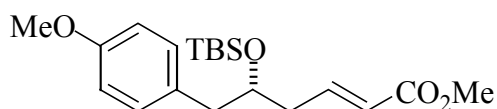
Methyl (2E,5R)-5-[[*tert*-butyl(dimethyl)silyloxy]-6-(4-methoxyphenyl)-2-hexenoate (128)

A mixture of the aldehyde **127** (10.1 g, 34 mmol) and carbomethoxymethylene triphenylphosphorane (**80**) (13.6 g, 40.8 mmol) in benzene (340 mL) was refluxed overnight (80 °C, 13 h). The resulting precipitate was removed by filtration and washed

with Et₂O. The filtrate was concentrated and the residue purified by chromatography (petroleum ether/Et₂O, 11:1) to afford the enoate **128** as a pale yellow oil (11.0 g, 93%, trans/cis, 93:7 as determined by relative peak heights in the ¹H NMR spectrum). TLC (petroleum ether/ethyl acetate, 8:1): R_f = 0.54; [α]_D²⁵ -5.4 (*c* 1.08, CH₂Cl₂).

¹H NMR (400 MHz, CDCl₃): δ = -0.17, -0.04 (2 s, 3H each, SiCH₃), 0.85 (s, 9H, SiC(CH₃)₃), 2.23-2.37 (m, 2H, H-4), 2.67 (dd, *J* = 6.5, 2.7 Hz, 2H, H-6), 3.72 (s, 3H, CO₂CH₃), 3.77 (s, 3H, C₆H₄OCH₃), 3.90-3.92 (m, 1H, H-5), 5.82 (d, *J* = 15.7 Hz, 1H, H-2), 6.81 (d, *J* = 8.6 Hz, 2H, aromatic H), 6.99 (dt, *J* = 15.7, 7.6 Hz, 1H, H-3), 7.06 (d, *J* = 8.6 Hz, 2H, aromatic H).

¹³C NMR (100 MHz, CDCl₃): δ = -4.9 (SiCH₃), 18.0 (SiC(CH₃)₃), 25.8 (SiC(CH₃)₃), 39.6 (C-4), 43.0 (C-6), 51.4 (CO₂CH₃), 55.2 (C₆H₄OCH₃), 72.7 (C-5), 113.6 (aromatic C), 123.0 (C-2), 130.5, 130.6 (aromatic C), 146.1 (C-3), 158.1 (aromatic C), 166.8 (C-1).

IR (neat): $\tilde{\nu}$ = 2953, 2930, 2857, 1726, 1513, 1249 cm⁻¹.

HRMS: calcd. for C₂₀H₃₂O₄SiNa 387.19621, found 387.19627.

(2*E*,5*R*)-5-[[*tert*-Butyl(dimethyl)silyl]oxy]-6-(4-methoxyphenyl)-2-hexen-1-ol (129**)**

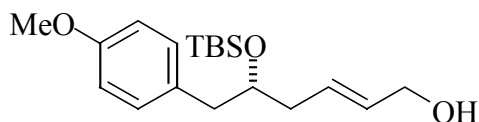

To a solution of ester **128** (15.3 g, 41.9 mmol) in CH₂Cl₂ (84 mL) was added DIBAL-H (1.0 M in hexane, 92 mL, 92 mmol) dropwise at -78 °C over 15 min. After being stirred for 2 h at -78 °C, the temperature was raised to -10 °C, methanol (2 mL) was added, and the mixture allowed to reach 0 °C. Then a saturated solution of potassium sodium tartarate (100 mL) was added. The layers were separated and the aqueous layer was extracted with CH₂Cl₂ (3 x 30 mL). The combined organic layers were washed with brine, dried (MgSO₄), filtered and concentrated. The crude product was purified by flash chromatography (petroleum ether/Et₂O, 1:2) to yield 13.0 g (92%) of alcohol **129** as a pale yellow oil. TLC (petroleum ether/ethyl acetate, 3:1): R_f = 0.45; [α]_D²⁶ -12.7 (*c* 0.95, CH₂Cl₂).

¹H NMR (400 MHz, CDCl₃): δ = -0.20, -0.06 (2 s, 3H each, SiCH₃), 0.84 (s, 9H, SiC(CH₃)₃), 2.12-2.25 (m, 2H, H-4), 2.59-2.70 (m, 1H, H-6), 3.77 (s, 3H, CH₃), 3.81-3.84 (m, 1H,

H-5), 4.10 (d, $J = 5.3$ Hz, 2H, H-1), 5.61-5.76 (m, 2H, H-2, H-3), 6.80 (d, $J = 8.6$ Hz, 2H, aromatic H), 7.06 (d, $J = 8.6$ Hz, 2H, aromatic H).

^{13}C NMR (100 MHz, CDCl_3): $\delta = -5.0, -4.8$ (SiCH_3), 18.1 ($\text{SiC}(\text{CH}_3)_3$), 25.8 ($\text{SiC}(\text{CH}_3)_3$), 39.8 (C-4), 42.7 (C-6), 55.2 (CH_3), 63.8 (C-1), 73.5 (C-5), 113.5 (aromatic C), 129.3 (C-3), 130.7, 131.1 (aromatic C), 131.5 (C-2), 158.0 (aromatic C).

IR (neat): $\tilde{\nu} = 3352$ (br), 2954, 2929, 2856, 1513, 1248 cm^{-1} .

HRMS: calcd. for $\text{C}_{19}\text{H}_{32}\text{O}_3\text{SiNa}$ 359.20129, found 359.20119.

[(1*S*,2*R*)-2-(3-(2*R*)-2-[[*tert*-Butyl(dimethyl)silyl]oxy]-1-(4-methoxyphenyl)propyl)cyclopropyl]methanol (130**)**

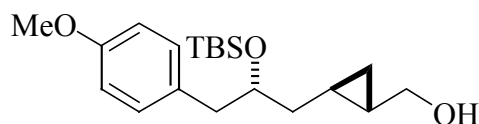

To a mixture of CH_2Cl_2 (300 mL) and 1,2-dimethoxyethane (DME) (8.2 mL, 78.8 mmol) was added a solution of diethylzinc (1.0 M in hexane, 90 mL, 90 mmol) at -10 °C followed by the dropwise addition of CH_2I_2 (13 mL, 158 mmol) over 15 min while maintaining the internal temperature between -8 and -12 °C. After complete addition, the resulting clear solution was stirred for 10 min at -10 °C before a solution of dioxaborolane ligand **67** (12.8 g, 47.3 mmol) in CH_2Cl_2 (47 mL, 1.0 M) was added via cannula over a 10 min while maintaining the internal temperature below -5 °C. This was followed by the dropwise addition of allylic alcohol **129** (13.5 g, 39.4 mmol), dissolved in CH_2Cl_2 (40 mL) while maintaining the internal temperature below -5 °C. After being stirred for 0.5 h at -10 °C, the mixture was allowed to reach room temperature and stirred for 17 h. The reaction was quenched with saturated NH_4Cl solution (30 mL) and 10% of HCl (120 mL) and the mixture was extracted with Et_2O (3 x 75 mL). The combined organic layers were added to a mixture of 2 N NaOH (180 mL) and H_2O_2 (30%, 30 mL). The biphasic solution was stirred for 5 min and then the layers were separated. The organic phase was washed with 10% of HCl (150 mL), Na_2SO_3 (150 mL), NaHCO_3 (150 mL), and brine (150 mL). After drying (MgSO_4), filtration and concentration of the organic layer under reduced pressure, the crude product was purified by flash chromatography (petroleum ether/ Et_2O , 1:4) to afford **130** as a colorless oil (13.25 g, 96%, the diastereomeric ratio was determined in the

next step). TLC (petroleum ether/ethyl acetate, 2:1): $R_f = 0.52$; $[\alpha]_D^{28} +6.17$ (c 0.95, CH_2Cl_2).

$^1\text{H NMR}$ (400 MHz, CDCl_3): $\delta = -0.18, -0.05$ (2 s, 3H each, SiCH_3), 0.24-0.28 (m, 1H, cyclopropane CH_2), 0.35-0.39 (m, 1H, cyclopropane CH_2), 0.67-0.75 (m, 1H, H-2'), 0.82-0.86 (m, 2H, H-1'), 0.85 (s, 9H, $\text{SiC}(\text{CH}_3)_3$), 1.23-1.30 (m, 1H, H-1''), 1.45-1.52 (m, 1H, H-1''), 1.91 (s, br, 1H, OH), 2.66-2.78 (m, 2H, H-3''), 3.39-3.50 (m, 2H, CH_2OH), 3.80-3.88 (m, 1H, H-2''), 6.79 (d, $J = 8.6$ Hz, 2H, aromatic H), 7.07 (d, $J = 8.6$ Hz, 2H, aromatic H).

$^{13}\text{C NMR}$ (100 MHz, CDCl_3): $\delta = -4.9, -4.8$ (SiCH_3), 10.0 (cyclopropane CH_2), 13.5 (cyclopropane C-2'), 18.0 ($\text{SiC}(\text{CH}_3)_3$), 21.3 (cyclopropane C-1'), 25.9 ($\text{SiC}(\text{CH}_3)_3$), 40.8 (C1''), 42.9 (C3''), 55.2 (CH_3), 67.0 (CH_2OH), 74.0 (CHOR), 113.5, 130.6, 131.4, 157.9 (aromatic C).

IR (neat): $\tilde{\nu} = 3349$ (br), 2954, 2929, 2857, 1513, 1248 cm^{-1} .

HRMS: calcd. for $\text{C}_{20}\text{H}_{34}\text{O}_3\text{SiNa}$ 373.21694, found 373.21684.

(1*R*,2*R*)-1-[3-(2*R*)-2-[[*tert*-Butyl(dimethyl)silyl]oxy]-1-(4-methoxyphenyl)propyl]-2-(iodomethyl)cyclopropane (133)

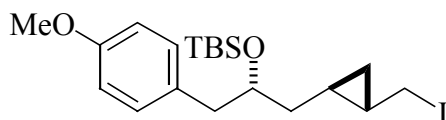

A mixture of triphenyl phosphite (4.0 mL, 15 mmol) and methyl iodide (1.25 mL, 20 mmol) was heated under gentle reflux until the internal temperature had risen to about 120 °C (over 6 h). The reaction mixture was stirred in the dark for 16 h at 120 °C. At this point the mixture was dark and viscous. The reaction mixture was allowed to cool to room. The alcohol **130** was added to the with the previously prepared methyl triphenoxyphosphonium iodide. The mixture was vigorously stirred until it became homogeneous and allowed to stand overnight (14 h) at room temperature. The crude reaction mixture was purified by chromatography (petroleum ether/ethyl acetate, 50:1) to afford the iodide **133** as a pale yellow oil (2.19 g, 48% yield) which is used immediately

for the next step. TLC (petroleum ether/ethyl acetate, 20:1): $R_f = 0.56$; $[\alpha]_D^{26} +1.66$ (c 0.65, CH_2Cl_2).

^1H NMR (400 MHz, CDCl_3): $\delta = -0.21, -0.07$ (2 s, 3H each, SiCH_3), 0.44-0.48 (m, 1H, cyclopropane CH_2), 0.55-0.60 (m, 1H, cyclopropane CH_2), 0.74-0.79 (m, 1H, H-2'), 0.83 (s, 9H, $\text{SiC}(\text{CH}_3)_3$), 1.02-1.10 (m, 1H, H-1'), 1.28-1.44 (m, 2H, H-1''), 2.63-2.68 (m, 1H, H-3'), 2.78-2.82 (m, 1H, H-3'), 3.10-3.20 (m, 2H, H-1), 3.78 (s, 3H, CH_3), 3.82-3.88 (m, 1H, H-2''), 6.80 (d, $J = 8.4$ Hz, 2H, aromatic H), 7.10 (d, $J = 8.6$ Hz, 2H, aromatic H).

^{13}C NMR (100 MHz, CDCl_3): $\delta = -4.9, -4.8$ (SiCH_3), 13.7 (CH_2I), 18.1 ($\text{SiC}(\text{CH}_3)_3$), 18.2 (cyclopropane CH_2), 21.7 (cyclopropane C-2'), 23.5 (cyclopropane C-1'), 25.9 ($\text{SiC}(\text{CH}_3)_3$), 41.4 (C1''), 42.8 (C3''). 55.3 (CH_3), 73.6 (CHOR), 113.5, 130.7, 131.3, 158.0 (aromatic C).

IR (neat): $\tilde{\nu} = 2960, 2928, 2856, 1512, 1257$ cm^{-1} .

(3*R*,5*R*)-5-[*tert*-Butyl(dimethyl)silyl]oxy-6-(4-methoxyphenyl)-3-methylhex-1-ene (134)

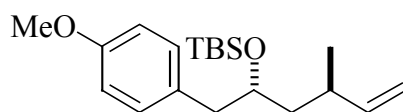

A solution of the crude iodide **133** (230 mg, 0.5 mmol) in dry Et_2O (5 mL) containing 4 Å molecular sieves (88 mg) and TMEDA (150 μL , 1 mmol) was treated with $n\text{-BuLi}$ (2.5 M in hexane, 0.4 mL, 1 mmol) at -78 °C. The resulting mixture was stirred at -78 °C for 0.5 h, then the temperature was raised to -30 °C over 2 h. The reaction was quenched with H_2O (2 mL). The layers were separated and the aqueous layer was extracted with Et_2O (3 x 5 mL). The combined organic layers were successively washed with 10% HCl (2 mL), saturated NaHCO_3 solution (2 mL), H_2O and brine, respectively. The organic layer was dried (MgSO_4), filtered, and concentrated. The crude product was purified by flash chromatography (petroleum ether/ethyl acetate, 40:1) to give the alkene **134** as a colorless oil (83 mg, 50% yield, $> 97\%$ de). TLC (petroleum ether/ethyl acetate, 40:1): $R_f = 0.42$; $[\alpha]_D^{26} +1.77$ (c 0.98, CH_2Cl_2).

^1H NMR (400 MHz, CDCl_3): $\delta = -0.19 -0.19, -0.04$ (2 s, 3H each, SiCH_3), 0.86 (s, 9H, $\text{SiC}(\text{CH}_3)_3$), 0.97 (d, $J = 6.8$ Hz, 3H, CHCH_3), 1.35-1.42 (m, 1H, H-4), 1.44-1.51 (m, 1H, H-4),

2.27-2.34 (m, 1H, H-3), 2.58-2.63 (m, 1H, H-6), 2.73-2.78 (m, 1H, H-6), 3.78 (s, 3H, OCH₃), 3.80-3.86 (m, 1H, H-5), 4.95 (d, $J = 10.4$ Hz, 1H, H-1), 5.00 (d, $J = 17.2$ Hz, 1H, H-1), 5.65-5.74 (m, 1H, H-2), 6.82 (d, $J = 8.6$ Hz, 2H, aromatic H), 7.10 (d, $J = 8.3$ Hz, 2H, aromatic H).

¹³C NMR (100 MHz, CDCl₃): $\delta = -4.8, -4.7$ (SiCH₃), 18.0 (SiC(CH₃)₃), 20.4 (CHCH₃), 25.9 (SiC(CH₃)₃), 34.5 (C-3), 42.7 (C-6), 44.0 (C-4), 55.2 (OCH₃), 71.9 (C-5), 112.6 (C-1), 113.5, 130.7, 131.4 (aromatic C), 144.6 (C-2), 157.9 (aromatic C).

IR (neat): $\tilde{\nu} = 3075, 2955, 2929, 2857, 1513, 1248$ cm⁻¹.

HRMS: calcd. for C₂₀H₃₄O₂SiNa 357.22203, found 357.22193.

(2R,4R)-1-(4-Methoxyphenyl)-4-methylhex-5-en-2-ol (135)

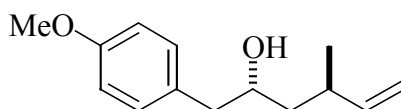

To a stirred solution of the silyl ether **134** (135 mg, 0.4 mmol) in dry THF (3 mL) at 0 °C was added TBAF (1.0 M in THF, 0.8 mL, 0.8 mmol). The reaction mixture was allowed to reach room temperature and stirred for 14 h. The reaction was quenched with saturated NH₄Cl solution (2 mL) and the aqueous layer extracted with Et₂O (3 x 5 mL). The combined organic layers were washed with brine (15 mL), dried (MgSO₄), filtered, and concentrated. The crude product was purified by short flash chromatography (petroleum ether/ethyl acetate 2:1) to yield the alcohol **135** as a colorless oil (53 mg, 60% yield). TLC (petroleum ether/ethyl acetate, 1:1): R_f = 0.48.

¹H NMR (400 MHz, CDCl₃): $\delta = 1.0$ (d, $J = 6.8$ Hz, 3H, CHCH₃), 1.39-1.46 (m, 1H, H-4), 1.52-1.59 (m, 1H, H-4), 1.82 (s, br, 1H, OH), 2.33-2.40 (m, 1H, H-3), 2.54-2.59 (m, 1H, H-6), 2.74-2.78 (m, 1H, H-6), 3.78 (s, 3H, OCH₃), 3.81-3.87 (m, 1H, H-5), 4.94 (d, $J = 10.4$ Hz, 1H, H-1), 5.03 (d, $J = 17.4$ Hz, 1H, H-1), 5.72-5.81 (m, 1H, H-2), 6.84 (d, $J = 8.6$ Hz, 2H, aromatic H), 7.11 (d, $J = 8.3$ Hz, 2H, aromatic H).

¹³C NMR (100 MHz, CDCl₃): $\delta = 20.0$ (CHCH₃), 35.1 (C-3), 43.0 (C-6), 43.4 (C-4), 55.2 (OCH₃), 71.1 (C-5), 112.7 (C-1), 113.9, 130.3, 132.4 (aromatic C), 144.9 (C-2), 158.2 (aromatic C).

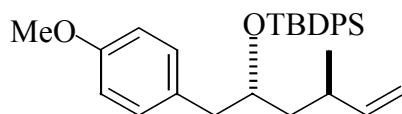
(3*R*,5*R*)-5-[*tert*-Butyl(diphenyl)silyl]oxy-6-(4-methoxyphenyl)-3-methylhex-1-ene (139)

To a stirred solution of alcohol **138** (51 mg, 0.24 mmol) in CH₂Cl₂ (1 mL) was added imidazole (35 mg, 0.48 mmol) at 0 °C and the mixture stirred for 5 min resulting in a homogeneous solution. Subsequently, *tert*-butyldiphenylsilyl chloride (68 μL, 0.26 mmol) was added and the whole mixture stirred for 0.5 h at 0 °C and then at room temperature for 14 h. The reaction mixture was diluted with H₂O, the layers were separated and the aqueous layer extracted with CH₂Cl₂ (2 x 3 mL). The combined organic layers were washed with brine, dried (MgSO₄), filtered, and concentrated. The crude product was purified by flash chromatography (petroleum ether/ethyl acetate 5:1) to yield the silyl ether **139** as a colorless oil (106 mg, 100% yield). TLC (petroleum ether/ethyl acetate, 8:1): R_f = 0.55; [α]_D²⁵ +13.4 (c 0.95, CH₂Cl₂).

¹H NMR (400 MHz, CDCl₃): δ = 0.71 (d, *J* = 6.6 Hz, 3H, CHCH₃), 1.04 (s, 9H, SiC(CH₃)₃), 1.24-1.31 (m, 1H, H-4), 1.35-1.42 (m, 1H, H-4), 2.20-2.28 (m, 1H, H-3), 2.65-2.76 (m, 2H, H-6), 3.78 (s, 3H, OCH₃), 3.86-3.92 (m, 1H, H-5), 4.78 (d, *J* = 10.1 Hz, 1H, H-1), 4.83 (d, *J* = 17.2 Hz, 1H, H-1), 5.29-5.38 (m, 1H, H-2), 6.76 (d, *J* = 8.6 Hz, 2H, aromatic H), 6.89 (d, *J* = 8.6 Hz, 2H, aromatic H), 7.33-7.46 (m, 6H, aromatic H), 7.59, 7.72 (d, *J* = 6.6 Hz, 2H each, aromatic H).

¹³C NMR (100 MHz, CDCl₃): δ = 19.3 (SiC(CH₃)₃), 20.0 (CHCH₃), 27.0 (SiC(CH₃)₃), 34.3 (C-3), 42.6 (C-6), 42.7 (C-4), 55.2 (OCH₃), 72.8 (C-5), 112.2 (C-1), 113.5, 127.4, 127.5, 129.4, 129.5, 130.5, 131.0, 134.3, 134.4, 136.0, 136.0 (aromatic C), 144.6 (C-2), 157.9 (aromatic C).

IR (neat): $\tilde{\nu}$ = 2931, 1508, 1462, 1246, 1084, 1038 cm⁻¹.

HRMS: calcd. for C₃₀H₃₈O₂SiNa 481.25333, found 481.25174.

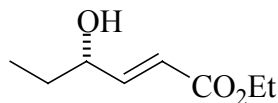
Ethyl (2*E*,4*S*)-4-hydroxyhex-2-enoate (149)**A. TADDOLate-titanium complex**

A two-neck flask was charged with TADDOL-Np (**148**) (1.33 g, 2 mmol), titanium (IV) isopropoxide (0.60 mL, 2 mmol) and toluene (15 mL). The solution was stirred for 4 h at room temperature. The reaction mixture was concentrated under reduced pressure at room temperature with vigorous stirring for 3 h to yield TADDOLate-Ti complex as a yellow amorphous solid. This complex was used as the alkylation catalyst.

B. Ethylation of ethyl (*E*)-4-oxobutenoate (144)

To a solution of the TADDOLate-Ti complex (from A), titanium(IV) isopropoxide (3.60 mL, 12 mmol) and ethyl (*E*)-4-oxobutenoate (**144**) (1.20 mL, 10 mmol) in toluene (40 mL) was added a solution of diethylzinc (1.0 *M* in hexane, 18 mL, 18 mmol) at -25 °C. The solution was stirred for 16 h at that temperature. After quenching the reaction with saturated NH₄Cl solution (20 mL) at -25 °C, the mixture was allowed to reach room temperature and then filtered through celite. The layers were separated and the aqueous layer extracted with Et₂O (3 x 30 mL). The combined organic layers were washed with brine, dried (MgSO₄), filtered, and concentrated to give a pale yellow oil. The crude product was purified by flash chromatography (petroleum ether/ethyl acetate 4:1) to yield alcohol **149** as a pale yellow oil (1.00 g, 64% yield, 98% ee). TLC (petroleum ether/ethyl acetate, 2:1): $R_f = 0.42$; $[\alpha]_D^{27} +23.2$ (c 1.12, CH₂Cl₂) {Ref.¹³⁹ $[\alpha]_D^{20} +25.0$ (c 1.83, CHCl₃)}.

¹H NMR (400 MHz, CDCl₃): $\delta = 0.94$ (t, $J = 7.5$ Hz, 3H, H-6), 1.26 (t, $J = 7.2$ Hz, 3H, OCH₂CH₃), 1.53-1.66 (m, 2H, H-5), 2.05 (s, br, 1H, OH), 4.13-4.24 (m, 1H, H-4), 4.17 (q, $J = 7.2$ Hz, 2H, OCH₂CH₃), 6.00 (dd, $J = 15.7, 1.8$ Hz, 1H, H-2), 6.91 (dd, $J = 15.7, 5.1$ Hz, 1H, H-3).

¹³C NMR (100 MHz, CDCl₃): $\delta = 9.4$ (C-6), 14.2 (OCH₂CH₃), 29.5 (C-5), 60.4 (OCH₂CH₃), 72.3 (C-4), 120.3 (C-2), 149.9 (C-3), 166.6 (C-1).

IR (neat): $\tilde{\nu} = 3437$ (br), 2974, 1712, 1277, 1176, 1041 cm⁻¹.

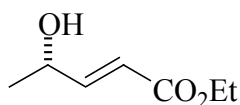
Ethyl (2*E*,4*S*)-4-hydroxypent-2-enoate (154)

The TADDOLate-Ti complex was prepared from TADDOL-Np (**148**) (333 mg, 0.5 mmol), titanium(IV) isopropoxide (0.15 mL, 0.5 mmol) and toluene (5 mL) as described before. To a solution of the TADDOLate-Ti complex, titanium(IV) isopropoxide (1.8 mL, 6 mmol) and ethyl (*E*)-4-oxobutenoate (**144**) (0.60 mL, 5.0 mmol) in toluene (20 mL) was added a solution of diethylzinc (2.0 *M* in hexane, 4.5 mL, 9.0 mmol) at -25 °C. The reaction was stirred for 24 h at that temperature. The other workup manipulations were carried out as described for the synthesis of **149**. The crude product was purified by flash chromatography (petroleum ether/ethyl acetate 4:1) to yield alcohol **154** as a pale yellow oil (712 mg, 99% yield, >99% ee). TLC (petroleum ether/ethyl acetate, 2:1): $R_f = 0.42$; $[\alpha]_D^{26} +24.7$ (c 1.04, CH_2Cl_2) {Ref. ^{141e} $[\alpha]_D^{22} +24$ (c 2.1, CHCl_3)}

¹H NMR (400 MHz, CDCl_3): $\delta = 1.26$ (t, $J = 7.1$ Hz, 3H, OCH_2CH_3), 1.31 (d, $J = 6.8$ Hz, 3H, H-5), 2.30 (s, 1H, OH), 4.17 (q, $J = 7.1$ Hz, 2H, OCH_2CH_3), 4.42-4.48 (m, 1H, H-4), 6.00 (dd, $J = 15.8, 1.6$ Hz, 1H, H-2), 6.93 (dd, $J = 15.7, 4.8$ Hz, 1H, H-3).

¹³C NMR (100 MHz, CDCl_3): $\delta = 14.2$ (OCH_2CH_3), 22.6 (C-5), 60.5 (OCH_2CH_3), 67.1 (C-4), 119.5 (C-2), 151.1 (C-3), 166.7 (C-1).

IR (neat): $\tilde{\nu} = 3436$ (br), 2978, 1712, 1277, 1176, 1045 cm^{-1} .

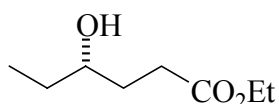
Ethyl (4*S*)-4-hydroxyhex-2-enoate (156)

Enoate **156** (159 mg, 1.0 mmol), 10 mol% Pd/C (10%, 18 mg), and dry EtOH (2 mL) was stirred for 54 h under 1 atm of hydrogen and then the mixture was filtered. The crude product was purified with flash chromatography (petroleum ether/ethyl acetate 4:1) and the filtrate was concentrated in vacua to yield hydroxy ester **156** as a colorless oil (139

mg, 87% yield). TLC (petroleum ether/ethyl acetate, 4:1): $R_f = 0.42$; $[\alpha]_D^{26} +0.20$ (c 1.13, CH_2Cl_2).

$^1\text{H NMR}$ (400 MHz, CDCl_3): $\delta = 0.90$ (t, $J = 7.3$ Hz, 3H, H-6), 1.20 (t, $J = 6.8$ Hz, 3H, OCH_2CH_3), 1.38-1.49 (m, 2H, H-5), 1.59-1.68 (m, 1H, H-3), 1.78-1.86 (m, 1H, H-3), 2.31-2.35 (m, 2H, H-2), 4.08 (q, $J = 6.9$ Hz, 2H, OCH_2CH_3).

$^{13}\text{C NMR}$ (100 MHz, CDCl_3): $\delta = 10.3$ (C-6), 14.6 (OCH_2CH_3), 31.2 (C-2), 32.1 (C-3), 34.8 (C-5), 60.8 (OCH_2CH_3), 73.0 (C-4), 174.7 (C-1).

IR (neat): $\tilde{\nu} = 3552$ (br), 2985, 1739, 1373, 1246, 1045 cm^{-1} .

(5S)-5-Ethyltetrahydro-2-furanone (**158**)

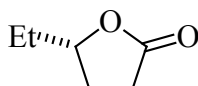

A mixture of 4-hydroxy ester **156** (137 mg, 0.86 mmol), concentrated HCl (0.5 mL) and H_2O (0.5 mL) was heated at 95 °C for 8 h. The organic materials were extracted with Et_2O (3 x 5 mL). The combined organic layers were washed with brine, dried (Na_2SO_4), filtered and concentrated to give **156** as a pale orange oil (71 mg, 73%). TLC (petroleum ether/ethyl acetate, 4:1): $R_f = 0.48$; $[\alpha]_D^{26} -30.5$ (c 0.97, CH_2Cl_2) {Ref.¹⁷ $[\alpha]_D^{24} -35.2$ (c 0.94, CHCl_3)}

$^1\text{H NMR}$ (400 MHz, CDCl_3): $\delta = 0.98$ (t, $J = 7.5$ Hz, 3H, CH_3), 1.59-1.89 (m, 3H, CH_2CHO), 2.26-2.34 (m, 3H, CH_2CHO), 2.49-2.54 (m, 2H, CH_2COO), 4.38-4.45 (m, 1H, $\text{CH}(\text{C}_2\text{H}_5)$).

$^{13}\text{C NMR}$ (100 MHz, CDCl_3): $\delta = 9.4$ (CH_3), 27.4 (CH_2CH_3), 28.8 (CH_2COO), 82.2 ($\text{CH}(\text{C}_2\text{H}_5)$), 177.3 (C-1).

IR (neat): $\tilde{\nu} = 2966$, 1461, 1358, 1180 cm^{-1} .

6 REFERENCES

1. (a) S. H. Sennett, P. J. McCarthy, A. E. Wright, S. A. Pomponi, *Pharmaceutical News*, **2002**, 9, 483-488; (b) D. J. Faulkner, *Nat. Prod. Rep.* **2000**, 17, 1-6; (c) D. J. Faulkner, *Antonie Van Leeuwenhoek*, **2000**, 77, 135-145; (d) D. J. Faulkner, *Nat. Prod. Rep.* **2002**, 19, 1-48; (e) N. Fusetani, *Drugs from the Sea*, Karger Publishers, Basel, **2000**, 1-5.
2. (a) P. Proksch, *Annual Plant Reviews*, **1999**, 3, 134-154; (b) M. F. Roberts, M. Wink, *Alkaloids: Biochemistry, ecology and medicinal applications*, Plenum, New York, **1998**, 379-394; (c) J. B. McClintock, B. J. Baker, *Marine Chemical Ecology*, CRC Press, Boca Raton, Florida, **2001**, 1.
3. (a) T. M. Zabriskie, J. A. Klocke, C. M. Ireland, A. H. Marcus, T. F. Molinski, D. J. Faulkner, C. Xu, J. C. Clardy, *J. Am. Chem. Soc.* **1986**, 108, 3123-3124; (b) P. Crews, L. V. Manes, M. Boehler, *Tetrahedron Lett.* **1986**, 27, 2797-2800.
4. Information from the Internet Hompages of Molecular Probes, Inc. (<http://www.probes.com>).
5. L. M. Murray, A. Johnson, P. Crews, *J. Org. Chem.* **1997**, 62, 5638-5643.
6. M. Sanders, M. C. Diaz, P. Crews, *Mem. Queensl. Mus.* **1999**, 44, 525-532.
7. V. R. Scott, R. Boehme, T. R. Matthews, *Antimicrob. Agents Chemother.* **1988**, 32, 1154-1157.
8. Information from Internet Hompages of Taxonomy of living organisms and viruses (<http://www.omne-vivum.com>).
9. O. R. Zaborsky, D. Attaway, *Marine Biotechnology*, Plenum Press, New York, New York, **1993**, 343-389.
10. H. Sawitzky, S. Liebe, J. Willingale-Theune, D. Menzel, *Eur. J. Cell Biol.* **1999**, 78, 424-433.
11. (a) P. Crews, J. J. Farias, R. Emrich, P. A. Keifer, *J. Org. Chem.* **1994**, 59, 2932-2936; (b) C. Odaka, M. L. Sanders, P. Crews, *Clin. Diagn. Lab. Immunol.* **2000**, 7, 947-952.
12. I. Fabian, I. Shur, I. Bleiberg, A. Rudi, Y. Kashman, M. Lishner, *Exp. Hematol.* **1995**, 23, 583-587.

13. H. Takeuchi, G. Ara, E. A. Sausville, B. Teicher, *Cancer Chemother. Pharmacol.* **1998**, *42*, 491-496.
14. (a) A. Holzinger, U. Meindl, *Cell Motil. Cytoskelet.* **1997**, *38*, 365-372; (b) A. M. Senderowicz, G. Kaur, E. Sainz, C. Laing, W. D. Inman, J. Rodriguez, P. Crews, L. Malspeis, M. R. Grever, E. A. Sausville, K. L. Duncan, *J. Natl. Cancer Inst.* **1995**, *87*, 46-51.
15. (a) L. P. Cramer, *Curr. Biol.* **1999**, *9*, 095-1105; (b) A. DiCampli, F. Valderrama, T. Babia, M. A. DeMatteis, A. Luini, G. Egea, *Cell Motil. Cytoskelet.* **1999**, *43*, 334-348; (c) I. Fabian, D. Halperin, S. Lefter, L. Mittelman, R. T. Altstock, O. Seaon, I. Tsarfaty, *Blood*, **1999**, *93*, 3994-4005; (d) O. Poupel, I. Tardieux, *Microbes Infect.* **1999**, *1*, 653-662; (e) S. Sheikh, W. B. Gratzner, J. C. Pinder, G. B. Nash, *Biochem. Biophys. Res. Commun.* **1997**, *238*, 910-915; (f) W. Shurety, N. L. Stewart, J. L. Stow, *Mol. Biol. Cell*, **1998**, *9*, 957-975; (g) M. P. Stewart, A. McDowall, N. Hogg, *J. Cell Biol.* **1998**, *140*, 699-707; (h) Y. Terada, C. Simerly, G. Schatten, *Mol. Reprod. Dev.* **2000**, *56*, 89-98.
16. (a) M. R. Bubb, A. M. Senderowicz, E. A. Sausville, K. L. Duncan, E. D. Korn, *J. Biol. Chem.* **1994**, *269*, 14869-14871; (b) M. R. Bubb, I. Spector, B. B. Beyer, K. M. Fosen, *J. Biol. Chem.* **2000**, *275*, 5163-5170.
17. T. Shioiri, T. Imaeda, Y. Hamada, *Heterocycles* **1997**, *46*, 421-442.
18. W. R. Chan, W. F. Tinto, P. S. Manchand, L. J. Todaro, *J. Org. Chem.* **1987**, *52*, 3091-3093.
19. (a) A. B. Smith, III, S. M. Condon, J. A. McCauley, *Acc. Chem. Res.* **1998**, *31*, 35-46; (b) S. L. Schreiber, *Bioorg. Med. Chem.* **1998**, *6*, 1127-1152.
20. (a) R. W. Hoffmann, M. Stahl, U. Schopfer, G. Frenking, *Chem. Eur. J.* **1998**, *4*, 559-566; (b) R. W. Hoffmann, D. Stenkamp, T. Trieselmann, R. Göttlich, *Eur. J. Org. Chem.* **1999**, 2915-2927; (c) R. W. Hoffmann, *Angew. Chem.* **2000**, *112*, 2134-2150; *Angew. Chem. Int. Ed. Engl.* **2000**, *39*, 2054-2070; (d) R. W. Hoffmann, R. Göttlich, U. Schopfer, *Eur. J. Org. Chem.* **2001**, 1865-1871.
21. A conformational search (Macromodel) on a derivative of **3** (methyl ester, 8-O-acetyl) revealed 6 low energy conformations (within 1 kcal of the minimum). In 4 of these, the conformation corresponds to the one depicted in Figure **2.4**.
22. (a) P. A. Grieco, Y. S. Hon, A. Perez-Medrano, *J. Am. Chem. Soc.* **1988**, *110*, 1630-1631; (b) U. Schmidt, W. Siegel, K. Mundinger, *Tetrahedron Lett.* **1988**, *29*, 1269-1270.

23. (a) K. S. Chu, G. R. Negrete, J. P. Konopelski, *J. Org. Chem.* **1991**, *56*, 5196-5202; (b) A. V. Rama Rao, M. K. Gurjar, B. R. Nallaganchu, A. Bhandari, *Tetrahedron Lett.* **1993**, *34*, 7085-7088; (c) Y. Hirai, K. Yokota, T. Momose, *Heterocycles* **1994**, *39*, 603-612; (d) P. Ashworth, B. Broadbelt, P. Jankowski, P. Kocienski, A. Pimm, R. Bell, *Synthesis*, **1995**, *60*, 199-206.
24. S. Kato, Y. Hamada, T. Shioiri, *Tetrahedron Lett.* **1988**, *29*, 6465-6466.
25. T. Imaeda, Y. Hamada, T. Shioiri, *Tetrahedron Lett.* **1994**, *35*, 591-594.
26. J. D. White, J. C. Amedio, *J. Org. Chem.* **1989**, *54*, 736-738.
27. J. D. White, T. C. Somers, G. N. Reddy, *J. Am. Chem. Soc.* **1986**, *104*, 5352-5353.
28. (a) Y. Hirai, K. Yokota, H. Sakai, T. Yamazaki, T. Momose, *Heterocycles* **1989**, *29*, 1865-1869; (b) Y. Hirai, K. Yokota, T. Yamazaki, T. Momose, *Ibid* **1990**, *30*, 1101-1119.
29. E. J. Corey, T. Hase, *Tetrahedron Lett.* **1979**, *20*, 335-338.
30. S.-K. Kang, D. Lee, *Synlett* **1991**, *2*, 175-176.
31. K. Hiyama, K. Kobayashi, *Tetrahedron Lett.* **1984**, *25*, 569-572.
32. A. V. Rama Rao, M. K. Gurjar, B. R. Nallaganchu, A. Bhandari, *Tetrahedron Lett.* **1993**, *34*, 7081-7084.
33. R. R. Fowell, *The Yeasts* **1969**, London: Academic Press Inc. Ltd., 461-471.
34. (a) M. Tosa, C. Paizs, C. Majdik, R. Misca, F. D. Irimie, *Roum. Biotechnol. Lett.* **2001**, *6*, 305-313; (b) T. Ema, Y. Sugiyama, M. Fukumoto, H. Moriya, J.-N. Cui, T. Sakai, M. Utaka, *J. Org. Chem.* **1998**, *63*, 4996-5000.
35. R. Csuk, B. Glanzer, *Chem. Rev.* **1991**, *91*, 49-97.
36. D. Seebach, M. A. Sutter, R. H. Weber, M. F. Züger, *Org. Synth., Coll. Vol.* **1990**, *7*, 215-220.
37. H. E. Simmons, R. D. Smith, *J. Am. Chem. Soc.* **1958**, *80*, 5323-5324.
38. J. Furukawa, N. Kawabata, J. Nishimura, *Tetrahedron Lett.* **1966**, *7*, 3353-3355.
39. (a) A. B. Charette, H. Lebel, A. Gagnon, *Tetrahedron* **1999**, *55*, 8845-8856; (b) S. E. Denmark, B. L. Christenson, S. P. O'Conner, N. Murase, *Pure Appl. Chem.* **1996**, *68*, 23-27; (c) A. B. Charette, C. Brochu, *J. Am. Chem. Soc.* **1995**, *117*, 11367-11368.
40. (a) S. Hanessian, D. Andreotti, A. Gomtsyan, *J. Am. Chem. Soc.* **1995**, *117*, 10393-10394; (b) A. B. Charette, N. Turcotte, J.-F. Marcoux, *Tetrahedron Lett.* **1994**, *35*, 513-516; (c) J. Kang, G. J. Lim, S. K. Yoon, M. Y. Kim, *J. Org. Chem.* **1995**, *60*, 564-577; (d) T. Taguchi, T. Morikawa, H. Sasaki, R. Hanai, A. Shibuya, *J. Org. Chem.* **1994**, *59*, 97-103.

41. (a) J. H.-H. Chan, B. Rickborn, *J. Am. Chem. Soc.* **1968**, *90*, 6406-6411; (b) J. A. Staroscik, B. Rickborn, *J. Org. Chem.* **1972**, *37*, 738-740; (c) S. Winstein, J. Sonnenberg, L. Vries, *J. Am. Chem. Soc.* **1959**, *81*, 6523-6524; (d) S. Winstein, J. Sonnenberg, *J. Am. Chem. Soc.* **1961**, *83*, 3235-3244.
42. (a) A. B. Charette, H. Juteau, H. Lebel, C. Molinaro, *J. Am. Chem. Soc.* **1998**, *120*, 11943-11952; (b) A. B. Charette, S. Francoeur, J. Martel, N. Wilb, *Angew. Chem.* **2000**, *112*, 4713-4716; *Angew. Chem. Int. Ed. Engl.* **2000**, *39*, 4539-4542; (c) A. B. Charette, C. Molinaro, C. Brochu, *J. Am. Chem. Soc.* **2001**, *123*, 12168-12175.
43. (a) A. B. Charette, H. Juteau, *J. Am. Chem. Soc.* **1994**, *116*, 2651-2652; (b) S. E. Denmark, J. P. Edwards, *Synlett* **1992**, *3*, 229-230; (c) T. Fujisawa, Y. Ukaji, M. Nishimura, *Chem. Lett.* **1992**, 61-64.
44. M. Nakamura, A. Hirai, E. Nakamura, *J. Am. Chem. Soc.* **2003**, *125*, 2341-2350.
45. (a) A. Barrett, K. Kasdorf, D. Williams, *J. Chem. Soc., Chem. Commun.* **1994**, 1781-1782; (b) A. Barrett, W. Doubleday, G. Tustin, A. White, D. Williams, *J. Chem. Soc., Chem. Commun.* **1994**, 1783-1784; (c) A. Barrett, G. Tustin, *J. Chem. Soc., Chem. Commun.* **1995**, 355-356; (d) A. Barrett, K. Kasdorf *Chem. Commun.* **1996**, 325-326.
46. S. J. Connon, S. Blechert, *Angew. Chem.* **2003**, *115*, 1944-1968; *Angew. Chem. Int. Ed. Engl.* **2003**, *42*, 1900-1923.
47. (a) K. J. Ivin, C. J. Mol, *Olefin Metathesis and Metathesis Polymerization* **1997**, Academic Press: San Diego; (b) R. H. Grubbs, *Handbook of Olefin Metathesis* **2003**, Wiley-VCH: Weinheim, Germany; (c) A. Fürstner, *Angew. Chem.* **2000**, *112*, 3140-3172; *Angew. Chem., Int. Ed. Engl.* **2000**, *39*, 3012-3043; (d) T. M. Trnka, R. H. Grubbs, *Acc. Chem. Res.* **2001**, *34*, 18-29.
48. A. K. Chatterjee, T.-L. Choi, D. P. Sanders, R. H. Grubbs, *J. Am. Chem. Soc.* **2003**, *125*, 11360-11370.
49. (a) J. P. Morgan, R. H. Grubbs, *Org. Lett.* **2000**, *2*, 3153-3155; (b) M. Scholl, S. Ding, C. W. Lee, R. H. Grubbs, *Org. Lett.* **1999**, *1*, 953-956; (c) M. Scholl, T. M. Trnka, J. P. Morgan, R. H. Grubbs, *Tetrahedron Lett.* **1999**, *40*, 2247-2250.
50. (a) J. Huang, E. D. Stevens, S. P. Nolan, J. L. Petersen, *J. Am. Chem. Soc.* **1999**, *121*, 2674-2678; (b) T. Weskamp, W. C. Schattenmann, M. Spiegler, W. A. Herrmann, *Angew. Chem.* **1998**, *110*, 2631-2633; *Angew. Chem., Int. Ed. Engl.* **1998**, *37*, 2490-2493; (c) T. Weskamp, F. J. Kohl, W. Hieringer, D. Gleich, W. A. Herrmann, *Angew. Chem.* **1999**, *111*, 2573-2576; *Angew. Chem., Int. Ed. Engl.* **1999**, *38*, 2416-2419.
51. J. L. Hérisson, Y. Chauvin, *Makromol. Chem.* **1971**, *141*, 161-176.

52. (a) C. Adlhart, P. Chen, *J. Am. Chem. Soc.* **2004**, *126*, 3496-3510; (b) M. S. Sanford, J. A. Love, R. H. Grubbs, *J. Am. Chem. Soc.* **2001**, *123*, 6543-6554.
53. D. A. Evans, H. Bartroli, T. L. Shih, *J. Am. Chem. Soc.* **1981**, *103*, 2127-2129.
54. (a) D. A. Evans, E. B. Sjogren, *Tetrahedron Lett.* **1985**, *26*, 3787-3790; (b) D. A. Evans, A. E. Weber, *J. Am. Chem. Soc.* **1986**, *108*, 6757-6761.
55. (a) C. Gaul, D. Seebach, *Org. Lett.* **2000**, *2*, 1501-1504; (b) D. A. Evans, L. D. Wu, J. J. M. Wiener, J. S. Johnson, D. H. B. Ripin, J. S. Tedrow, *J. Org. Chem.* **1999**, *64*, 6411-6417; (c) D. J. Ager, I. Prakash, D. R. Schaad, *Chem. Rev.* **1996**, *96*, 835-875; (d) D. A. Evans, J. M. Takacs, L. R. McGee, M. D. Ennis, D. J. Mathre, J. Bartroli, *Pure & Appl. Chem.* **1981**, *53*, 1109-1127.
56. (a) D. A. Evans, *Aldrichim. Acta*, **1982**, *15*, 23-32; (b) D. A. Evans, *Asymmetric Synthesis*; J. D. Morrison, Ed.; Academic Press: Orlando, FL **1984**, Vol. 3, p. 1; (c) D. A. Evans, T. C. Britton and J. A. Ellman, *Tetrahedron Lett.* **1987**, *28*, 6141-6144.
57. T. Hintermann, D. Seebach, *Helv. Chim. Acta* **1998**, *81*, 2093-2126.
58. (a) J. R. Gage, D. A. Evans, *Org. Synth.* **1989**, *68*, 77-82; (b) J. Gage, D. A. Evans, *Org. Synth.* **1989**, *68*, 83-91.
59. D. A. Evans, M. D. Ennis, D. J. Mathre, *J. Am. Chem. Soc.* **1982**, *104*, 1737-1739.
60. S.-M. Kim, H. Jin, J.-G. Jun, *Bull. Korean Chem. Soc.* **2002**, *23*, 749-757.
61. (a) K. Mori, Z.-H. Qian, *Bull. Soc. Chim. Fr.* **1993**, *130*, 382-387; (b) D. Romo, R. M. Rzas, H. A. Shea, K. Park, J. M. Langenhan, L. Sun, A. Akhiezer, J. O. Liu, *J. Am. Chem. Soc.* **1998**, *120*, 12237-12254; (c) K. Marukawa, K. Mori, *Eur. J. Org. Chem.* **2002**, 3974-3978.
62. G. Solladié, F. Somny, F. Colobert, *Tetrahedron: Asymmetry* **1997**, *8*, 801-810.
63. (a) B. Ernst, B. Wagner, *Helv. Chim. Acta* **1989**, *72*, 165-171; (b) J. Sakaki, Y. Sugita, M. Sato, C. Kaneko, *Tetrahedron* **1991**, *47*, 6197-6214; (c) K. Ohta, O. Miyagawa, H. Tsutsui, O. Mitsunobu, *Bull. Chem. Soc. Jpn.* **1993**, *66*, 523-535; (d) H. Nakamura, M. Ono, Y. Shida, H. Akita, *Tetrahedron: Asymmetry* **2002**, *13*, 705-713.
64. (a) M. Villa, J. Villa, S. Warren, *J. Chem. Soc., Perkin Trans.1* **1994**, *12*, 1569-1572; (b) Y. Elemes, C. S. Foote, *J. Am. Chem. Soc.* **1992**, *114*, 6044-6050; (c) T. M. Werkhoven, R. V. Nispen, J. Lugtenburg, *Eur. J. Org. Chem.* **1999**, *11*, 2909-2914; (d) *Organic Syntheses Coll. Vol.* **1990**, *7*, 232-235; (e) M. Casey, J. Leonard, B. Lygo, G. Procter, *Advance Practical Organic Chemistry*, Blackie, Glasgow, **1990**, 233-234.

65. (a) G. E. Keck, A. Palani, S. F. McHardy, *J. Org. Chem.* **1994**, *59*, 3113-3122; (b) K. B. Jorgensen, T. Suenaga, T. Nakata, *Tetrahedron Lett.* **1999**, *40*, 8855-8858; (c) K. B. Jorgensen, H. Koshino, T. Nakata, *Heterocycles* **1998**, *47*, 679-683.
66. H. Nagaoka, M. Iwashima, H. Abe, K. Iguchi, Y. Yamada, *Chem. Pharm. Bull.* **1992**, *40*, 1742-1749.
67. (a) A. Charette, J. Naud, *Tetrahedron Lett.* **1998**, *39*, 7259-7262; (b) A. K. Ghosh, C. Liu, *Org. Lett.* **2001**, *3*, 635-638.
68. A. B. Charette, H. Lebel, *Org. Synth.* **1999**, *76*, 86-100.
69. D. Seebach, H.-O. Kalinowski, W. Langer, G. Crass, E.-M. Wilka, *Org. Synth., Coll. Vol.* **1990**, *7*, 14-50.
70. M. E. Kuehne, S. D. Cowen, F. Xu, L. S. Borman, *J. Org. Chem.* **2001**, *66*, 5303-5316.
71. (a) L. Xie, Y. Takeuchi, L. M. Cosentino, K. H. Lee, *J. Med. Chem.* **1999**, *42*, 2662-2672; (b) F. J. H. M. Jansen, M. Kwestro, D. Schmitt, J. Lugtenburg, *Rec. Trav. Chim. Pays-Bas* **1994**, *113*, 552-562; (c) S. Uesato, K. Kobayashi, H. Inouye, *Chem. Pharm. Bull.* **1982**, *30*, 927-940.
72. (a) Y. S. Hon, L. Lu, *Tetrahedron* **1995**, *51*, 7937-7942; (b) Y. S. Hon, L. Lu, R. C. Chang, S. W. Lin, P. P. Sun, C. F. Lee, *Tetrahedron* **2000**, *56*, 9269-9279.
73. (a) M. R. Pitts, J. Mulzer, *Tetrahedron Lett.* **2002**, *43*, 8471-8473; (b) G. Mas, L. Gonzalez, J. Vilarrasa, *Tetrahedron Lett.* **2003**, *44*, 8805-8809.
74. (a) T. Owa, A. Haupt, M. Otsuka, S. Kobayashi, N. Tomioka, A. Itai, M. Ohno, T. Shiraki, M. Uesugi, Y. Sugiura, K. Maeda, *Tetrahedron* **1992**, *48*, 1193-1208; (b) R. L. Funk, J. B. Stallman, J. A. Wos, *J. Am. Chem. Soc.* **1993**, *115*, 8847-8848; (c) C. Carfagna, L. Mariani, A. Musco, G. Sallese, R. Santi, *J. Org. Chem.* **1991**, *56*, 3924-3927.
75. (a) S. He, S. A. Kozmin, V. H. Rawal, *J. Am. Chem. Soc.* **2000**, *122*, 190-191; (b) D. N. Moraes, R. A. Santos, J. V. Comasseto, *J. Braz. Chem. Soc.* **1998**, *9*, 397-403; (c) H. M. C. Ferraz, C. M. R. Ribeiro, *Synthetic Comm.* **1992**, *22*, 399-404.
76. (a) M. A. Brimble, *Aust. J. Chem.* **1990**, *43*, 1035-1046; (b) D. A. Evans, R. P. Polniaszek, K. M. DeVries, D. E. Guinn, D. J. Mathre, *J. Am. Chem. Soc.* **1991**, *113*, 7613-7630; (c) A. Abiko, O. Moriya, S. A. Filla, S. Masamune, *Angew. Chem. Int. Ed. Engl.* **1995**, *34*, 793-795; (d) M. Scheck, H. Waldmann, *Can. J. Chem.* **2002**, *80*, 571-576; (e) R. Baker, M. A. Brimble, *Tetrahedron Lett.* **1986**, *27*, 3311-3314; (f) D. A. Evans, J. Bartroli, *Ibid* **1982**, *23*, 807-810.

77. R. Noyori, *Asymmetric Catalysis in Organic Synthesis*; Wiley, New York **1994**, 1.
78. A. Pfaltz, E. N. Jacobsen, H. Yamamoto, Ed.; *Comprehensive asymmetric catalysis*, Springer, Berlin Heidelberg New York **1999**, Vols 1–3, 1.
79. M. Kitamura, M. Tokunaga, T. Ohkuma, R. Noyori, *Org. Synth.* **1992**, *71*, 1-13.
80. (a) A. Miyashita, A. Yasuda, H. Takaya, K. Toriumi, T. Ito, T. Souchi, R. Noyori, *J. Am. Chem. Soc.* **1980**, *102*, 7932-7934; (b) K. Toriumi, T. Ito, H. Takaya, T. Souchi, R. Noyori, *Acta Crystallogr. Sect. B*, **1982**, *38*, 807-812.
81. R. Noyori, T. Ohkuma, M. Kitamura, H. Takaya, N. Sayo, H. Kumobayashi, S. Akutagawa, *J. Am. Chem. Soc.* **1987**, *109*, 5856-5858.
82. R. Noyori, T. Ohkuma, *Angew. Chem.* **2001**, *113*, 40-75; *Angew. Chem. Int. Ed. Engl.* **2001**, *40*, 40-73.
83. (a) M. Kitamura, M. Tokunaga, R. Noyori, *J. Am. Chem. Soc.* **1993**, *115*, 144-152; (b) M. Kitamura, M. Tokunaga, R. Noyori, *Tetrahedron* **1993**, *49*, 1853-1860; (c) R. Noyori, M. Tokunaga, M. Kitamura, *Bull. Chem. Soc. Jpn.* **1995**, *68*, 36-56.
84. (a) S. A. King, A. S. Thompson, A. O. King, T. R. Verhoeven, *J. Org. Chem.* **1992**, *57*, 6689-6691; (b) M. Kitamura, M. Yoshimura, N. Kanda, R. Noyori, *Tetrahedron* **1999**, *55*, 8769-8785.
85. R. Noyori, M. Kitamura, T. Ohkuma, *Proc. Natl. Acad. Sci. USA*, **2004**, *101*, 5356-5362.
86. R. Noyori, M. Tokunaga, M. Kitamura, *Bull. Chem. Soc. Jpn.* **1995**, *68*, 36-56.
87. V. A. Pavlov, *Russ. Chem. Rev.* **2001**, *70*, 1037-1065.
88. (a) M. Jackman, M. Klenk, B. Fishburn, B. F. Tullar, S. Archer, *J. Am. Chem. Soc.* **1948**, *70*, 2884-2886; (b) W. S. Johnson, N. P. Jensen, J. Hooz, E. J. Leopold, *Ibid.* **1968**, *90*, 5872-5881; (c) Y. L. Chen, W. F. Barthel, *Ibid.* **1953**, *75*, 4287-4289.
89. C. R. Holmquist, E. J. Roskamp, *J. Org. Chem.* **1989**, *54*, 3258-3260.
90. H. Akita, Y. C. Cheng, K. Kato, *Tetrahedron*, **1998**, *54*, 11011-11026.
91. M. Bauer, M. E. Maier, *Org. Lett.* **2002**, *4*, 2205-2208.
92. Y. Liu, Z. Li, J. C. Vederas, *Tetrahedron*, **1998**, *54*, 15937-15958.
93. E. Hungerbühler, D. Seebach, D. Wasmuth, *Helv. Chim. Acta* **1981**, *64*, 1467-1487.
94. W. Wierenga, H. I. Skulnick, *J. Org. Chem.* **1979**, *44*, 310-311.
95. (a) D. Cai, J. F. Payack, D. R. Bender, D. L. Hughes, T. R. Verhoeven, P. J. Reider, *Org. Synth.* **1999**, *76*, 6-11; (b) D. Cai, D. L. Hughes, T. R. Verhoeven, P. J. Reider, *Tetrahedron Lett.* **1995**, *36*, 7991-7994; (c) L. F. Tietze, T. Eicher, *Reaktionen und*

- Synthesen in organisch-chemischen Praktikum und Forschungslaboratorium* **1991**, P446-P449.
96. (a) S. Colonna, A. Re, H. Wynberg, *J. Chem. Soc., Perkins Trans. 1* **1981**, *1*, 547-552; (b) Y. Wang, J. Sun, K. Ding, *Tetrahedron* **2000**, *56*, 4447-4451.
97. (a) G.-H. Liu, Q.-H. Fan, X.-Q. Yang, X.-M. Chen, *Arkivoc* **2003** (ii), 123-132; (b) S. Matsunaga, T. Ohshima, M. Shibasaki, *Adv. Synth. Catal.* **2002**, *344*, 3-15; (c) S. E. Denmark, J. Fu, *Chem. Rev.* **2003**, *103*, 2763-2794; (d) A. Lattanzi, A. Scettri, *Curr. Org. Chem.* **2004**, *8*, 607-621; (e) P. Merino, S. Franco, P. Jimenez, T. Tejero, M. A. Chiacchio, *Lett. Org. Chem.* **2005**, *2*, 302-305; (f) Y.-C. Teo, K.-T. Tan, T.-P. Loh, *Chem. Commun.* **2005**, 1318-1320; (g) M. Bandini, P. G. Cozzi, A. Umami-Ronchi, *Pure Appl. Chem.* **2001**, *73*, 325-329; (h) K. Mikami, T. Korenaga, Y. Matsumoto, M. Ueki, M. Terada, S. Matsukawa, *Pure Appl. Chem.* **2001**, *73*, 255-259.
98. R. A. Strecker, J. L. Snead, G. P. Sollott, *J. Am. Chem. Soc.* **1973**, *95*, 210-214.
99. (a) S. E. Schaus, B. D. Brandes, J. F. Larrow, M. Tokunaga, K. B. Hansen, A. E. Gould, M. E. Furrow, E. N. Jacobsen, *J. Am. Chem. Soc.* **2002**, *124*, 1307-1315; (b) M. Tokunaga, J. F. Larrow, F. Kakiuchi, E. N. Jacobsen, *Science* **1997**, *277*, 936-938.
100. J. F. Larrow, K. E. Hemberger, S. Jasmin, H. Kabir, P. Morel, *Tetrahedron : Asymmetry* **2003**, *14*, 3633-3638.
101. J. M. Keith, J. F. Larrow, E. N. Jacobsen, *Adv. Synth. Catal.* **2001**, *343*, 5-26.
102. L. P. C. Nielsen, C. P. Stevenson, D. G. Blackmond, E. N. Jacobsen, *J. Am. Chem. Soc.* **2004**, *126*, 1360-1362.
103. S. Takano, Y. Iwabuchi, K. Ogasawara, *Heterocycles* **1989**, *29*, 1861-1864.
104. (a) Y. Fujimoto, Y. Suzuki, Y. Tanaka, T. Tominaga, H. Takeda, H. Sekine, N. Morito, Y. Naoya, *Heterocycles* **1977**, *6*, 1604-1609; (b) H.-J. Gais, M. Jungen, V. Jadhav, *J. Org. Chem.* **2001**, *66*, 3384-3396; (c) J. Kan, P. Toy, *Tetrahedron Lett.* **2004**, *45*, 6357-6359.
105. (a) T. Chuang, J. Fang, W. Jiaang, Y. Tsai, *J. Org. Chem.* **1996**, *61*, 1794-1805; (b) R. B. Silverman, X. Lu, G. M. Banik, *J. Org. Chem.* **1992**, *57*, 6617-6622; (c) M. E. Scheller, B. Frei, *Helv. Chim. Acta* **1984**, *67*, 1734-1747.
106. (a) A. B. Smith, A. M. Boldi, *J. Am. Chem. Soc.* **1997**, *119*, 6925-6926; (b) A. B. Smith, S. M. Pitram, *Org. Lett.* **1999**, *1*, 2001-2004.
107. P. J. Kocienski, *Tetrahedron Lett.* **1980**, *21*, 1559-1562.

108. Y. Mori, H. Kageyama, M. Suzuki, *Chem. Pharm. Bull.* **1990**, *38*, 2574-2576.
109. H. N. Rydon, *Org. Synth., Coll. Vol.* **1988**, *6*, 830-832.
110. A. K. Chatterjee, J. P. Morgan, M. Scholl, R. H. Grubbs, *J. Am. Chem. Soc.* **2000**, *122*, 3783-3784.
111. K. B. Sharpless, W. Amberg, Y. L. Bennani, G. A. Crispino, J. Hartung, K.-S. Jeong, H.-L. Kwong, K. Morikawa, Z.-M. Wang, D. Xu, X.-L. Zhang, *J. Org. Chem.* **1992**, *57*, 2768-2771.
112. W. D. Lloyd, B. J. Navarette, M. F. Shaw, *Synthesis* **1972**, 610-611.
113. (a) D. Seebach, M. Hayakawa, J. Sakaki, W. B. Schweizer, *Tetrahedron* **1993**, *49*, 1711-1724; (b) D. Seebach, *Angew. Chem.* **1990**, *102*, 1363-1409; *Angew. Chem. Int. Ed. Engl.* **1990**, *29*, 1320-1367.
114. R. Noyori, M. Kitamura, *Angew. Chem.* **1991**, *103*, 34-55; *Angew. Chem. Int. Ed. Engl.* **1991**, *30*, 46-69.
115. K. Soai, S. Niwa, *Chem. Rev.* **1992**, *92*, 833-856.
116. K. Soai, S. Yokoyama, T. Hayasaka, K. Ebihara, *Chem. Lett.* **1988**, 843-846.
117. (a) P. J. Walsh, *Acc. Chem. Res.* **2003**, *36*, 739-749; (b) P. J. Walsh, A. E. Lurain, J. Balsells, *Chem. Rev.* **2003**, *103*, 3297-3344; (c) Y. N. Belokon, K. A. Kochetkov, Tatiana D. Churkina, N. S. Ikonnikov, A. A. Chesnokov, O. V. Larionov, V. S. Parmar, *J. Org. Chem.* **2000**, *65*, 7041-7048; (d) Y. N. Belokon, S. Harutyunyan, E. V. Vorontsov, A. S. Peregudov, V. N. Chrustalev, K. A. Kochetkov, D. Pripadchev, A. S. Sagyan, A. K. Beck, D. Seebach, *Arkivoc* **2004** (iii) 132-150.
118. (a) B. Schmidt, D. Seebach, *Angew. Chem., Int. Ed. Engl.* **1991**, *30*, 1321-1323; (b) D. Seebach, L. Behrendt, D. Felix, *Angew. Chem., Int. Ed. Engl.* **1991**, *30*, 1008-1009; (c) Y. N. Ito, X. Ariza, A. K. Beck, A. Bohác, C. Ganter, R. E. Gawley, F. M. N. Kuhle, J. Tuleja, Y. M. Wang, D. Seebach, *Helv. Chim. Acta* **1994**, *77*, 2071-2110; (d) D. Seebach, A. K. Beck, B. Schmidt, Y. M. Wang, *Tetrahedron* **1994**, *50*, 4363-4384.
119. H. Takahashi, T. Kawakita, M. Ohno, M. Yoshioka, S. Kobayashi, *Tetrahedron* **1992**, *48*, 5691-5700.
120. D. A. Evans, S. G. Nelson, *J. Am. Chem. Soc.* **1997**, *119*, 6452-6453.
121. (a) H. Takahashi, M. Yoshioka, M. Ohno, S. Kobayashi, *Tetrahedron Lett.* **1992**, *33*, 2575-2578; (b) H. Takahashi, M. Yoshioka, M. Shibasaki, M. Ohno, N. Imai, S. Kobayashi, *Tetrahedron* **1995**, *51*, 12013-12026; (c) S. E. Denmark, S. P. O'Connor,

- J. Org. Chem.* **1997**, *62*, 3390-3401; (d) S. E. Denmark, S. P. O'Connor, *J. Org. Chem.* **1997**, *62*, 584-594.
122. E. J. Corey, S. Sarshar, D.-H. Lee, *J. Am. Chem. Soc.* **1994**, *116*, 12089-12090.
123. T. Ichiyanagi, M. Shimizu, T. Fujisawa, *J. Org. Chem.* **1997**, *62*, 7937-7941.
124. (a) M. J. Rozema, A. Sidduri, P. Knochel, *J. Org. Chem.* **1992**, *57*, 1956-1958; (b) M. J. Rozema, C. Eisenberg, H. Lutjens, R. Ostwald, K. Belyk, P. Knochel, *Tetrahedron Lett.* **1993**, *34*, 3115-3118; (c) W. Brieden, R. Ostwald, P. Knochel, *Angew. Chem., Int. Ed. Engl.* **1993**, *32*, 582-584; (d) S. Nowotny, S. Vettel, P. Knochel, *Tetrahedron Lett.* **1994**, *35*, 4539-4549; (e) L. Schwink, P. Knochel, *Tetrahedron Lett.* **1994**, *35*, 9007-9010; (f) H. Lutjens, P. A. Knochel, *Tetrahedron: Asymmetry* **1994**, *5*, 1161-1162; (g) R. Ostwald, P.-Y. Chavant, H. Stadtmuller, P. Knochel, *J. Org. Chem.* **1994**, *59*, 4143-4153; (h) H. Lutjens, S. Nowotny, P. Knochel, *Tetrahedron: Asymmetry* **1995**, *6*, 2675-2678; (i) K. Ito, Y. Kimura, H. Okamura, T. Katsuki, *Synlett* **1992**, *3*, 573-575; (j) K. Soai, Y. Hirose, Y. Ohno, *Tetrahedron: Asymmetry* **1993**, *4*, 1473-1474; (k) C. Dreisbach, U. Kragl, C. Wandrey, *Synthesis* **1994**, *59*, 911-912; (l) H. Waldmann, M. Weigerding, C. Dreisbach, C. Wandrey, *Helv. Chim. Acta* **1994**, *77*, 2111-2116; (m) P. Knochel, S. Vettel, C. Eisenberg, *Appl. Organometal. Chem.* **1995**, *9*, 175-188.
125. S. Pritchett, D. H. Woodmansee, P. Gantzel, P. J. Walsh, *J. Am. Chem. Soc.* **1998**, *120*, 6423-6424.
126. (a) N. Imai, H. Takahashi, S. Kobayashi, *Chem. Lett.* **1994**, 177-180; (b) S. E. Denmark, S. P. O'Connor, S. R. Wilson, *Angew. Chem., Int. Ed. Engl.* **1998**, *37*, 1149-1151; (c) S. Pritchett, D. H. Woodmansee, T. J. Davis, P. J. Walsh, *Tetrahedron Lett.* **1998**, *39*, 5941-5944.
127. M. Yoshioka, T. Kawakita, M. Ohno, *Tetrahedron Lett.* **1989**, *30*, 1657-1660.
128. R. O. Duthaler, A. Hafner, *Chem. Rev.* **1992**, *92*, 807-832.
129. D. Seebach, A. K. Beck, A. Heckel, *Angew. Chem.* **2001**, *113*, 96-142; *Angew. Chem., Int. Ed. Engl.* **2001**, *40*, 92-138.
130. D. Seebach, A. K. Beck, A. Heckel, *Angew. Chem.* **2001**, *113*, 1-1; *Angew. Chem., Int. Ed. Engl.* **2001**, *40*, 1-1.
131. (a) K. V. Gothelf, R. G. Hazzel, K. A. Jørgensen, *J. Am. Chem. Soc.* **1995**, *117*, 4435-4436; (b) D. Seebach, D. A. Plattner, A. K. Beck, Y. M. Wang, D. Hunziker, *Helv. Chim. Acta* **1992**, *75*, 2171-2209.
132. M. Braun, *Angew. Chem., Int. Ed. Engl.* **1996**, *35*, 519-522.

133. S. E. Denmark, B. L. Christenson, S. P. O'Connor, *Tetrahedron Lett.* **1995**, *36*, 2219-2222.
134. (a) J. Balsells, L. Mejorado, M. Phillips, F. Ortega, G. Aguirre, R. Somanathan, P. J. Walsh, *Tetrahedron: Asymmetry* **1998**, *9*, 4135-4142; (b) J. F. Larrow, E. N. Jacobsen, Y. Gao, Y. Hong, X. Nie, C. M. Zepp, *J. Org. Chem.* **1994**, *59*, 1939-1942; (c) J. F. Larrow, E. N. Jacobsen, *Org. Synth.* **1996**, *75*, 1-11.
135. H. Takahashi, T. Kawakita, M. Yoshioka, S. Kobayashi, M. Ohno, *Tetrahedron Lett.* **1989**, *50*, 7095-7098.
136. S. Pritchett, P. Gantzel, P. J. Walsh, *Organometallics* **1997**, *16*, 5130-5132.
137. M. Carmack, C. J. Kelley, *J. Org. Chem.* **1968**, *33*, 2171-2173.
138. (a) B. Weber, D. Seebach, *Tetrahedron* **1994**, *50*, 6117-6128; (b) C. Bussche-Hünnefeld, A. K. Beck, U. Lengweiler, D. Seebach, *Helv. Chim. Acta* **1992**, *75*, 438-441; (c) A. K. Beck, B. Bastani, D. A. Plattner, W. Petter, D. Seebach, H. Braunschweiger, P. Gysi, L. L. Vecchia, *Chimia* **1991**, *45*, 238-244; (d) J. Irurre, C. Alonso-Alija, J. F. Piniella, A. Alvarez-Larena, *Tetrahedron: Asymmetry*. **1992**, *3*, 1591-1596; (e) K. Narasaka, N. Iwasawa, M. Inoue, T. Yamada, M. Nakashima, J. Sugimori, *J. Am. Chem. Soc.* **1989**, *111*, 5340-5345; (f) D. Seebach, A. K. Beck, R. Imwinkelried, S. Roggo, A. Wonnacott, *Helv. Chim. Acta* **1987**, *70*, 954-974.
139. H. Nagatomo, Y.-I. Matsushita, K. Sugamoto, T. Matsui, *Tetrahedron: Asymmetry* **2003**, *14*, 2339-2350.
140. C. E. Dixon, K. Hellmund, S. G. Pyne, *J. Chem. Res. (S)*, **1996**, 372-373.
141. (a) B. M. Trost, J.-P. Surivet, F. D. Toste, *J. Am. Chem. Soc.* **2004**, *126*, 15592-15602; (b) M. C. Carreno, M. J. Sanz-Cuesta, F. Colobert, G. Solladie, *Org. Lett.* **2004**, *6*, 3537-3540; (c) R. Chow, P. J. Kocienski, A. Kuhl, J.-Y. LeBrazidec, K. Muir, P. Fish, *J. Chem. Soc., Perkin Trans. 1* **1994**, *19*, 2344-2355; (d) H. Yamaguchi, S. Nakanishi, T. Takata, *J. Organomet. Chem.* **1998**, *554*, 167-170; (e) J. Mulzer, G. Funk, *Synthesis*, **1995**, *60*, 101-112; (f) S. Tsuboi, J.-i. Sakamoto, T. Kawano, M. Utaka, A. Takeda, *J. Org. Chem.* **1991**, *56*, 7177-7179; (g) J. Mulzer, H. Bock, W. Eck, J. Buschmann, P. Luger, *Angew. Chem.* **1991**, *103*, 450-452; *Angew. Chem., Int. Ed. Engl.* **1991**, *30*, 414-416.
142. (a) B. Dhotare, S. A. Hassarajani, A. Chattopadhyay, *Enantiomer* **1999**, *4*, 431-436; (b) R. Noyori, M. Kitamura, *New Funct. Mater.* **1993**, C 389-392.
143. A. Mosandl, C. Guenther, *J. Agric. Food Chem.* **1989**, *37*, 413-418.
144. P. Mohr, L. Rösslein, C. Tamm, *Tetrahedron Lett.* **1989**, *30*, 2513-2516.

-
145. (a) H.-J. Ha, D.-G. Yi, K.-N. Yoon, C. E. Song, *Bull. Korean Chem. Soc.* **1996**, *17*, 544-547; (b) A. Oeveren, B. L. Feringa, *J. Org. Chem.* **1996**, *61*, 2920-2921; (c) J. L. Garcia Ruano, A. Fuerte, M. C. Maestro, *Tetrahedron: Asymmetry* **1994**, *5*, 1443-1446; (d) S. Tamogami, K. Awano, M. Amaiike, Y. Takagi, T. Kitahara, *Flavour Fragrance J.* **2002**, *16*, 349-352; (e) M. J. Cantalejo, *J. Agric. Food Chem.* **1997**, *45*, 1853-1860.
146. E. Pinard, A. Alanine, A. Bourson, B. Büttelmann, R. Gill, M.-P. Heitz, G. Jaeschke, V. Mutel, G. Trube, R. Wyler, *Bioorg. Med. Chem. Lett.* **2001**, *11*, 2173-2176.

7 APPENDIX

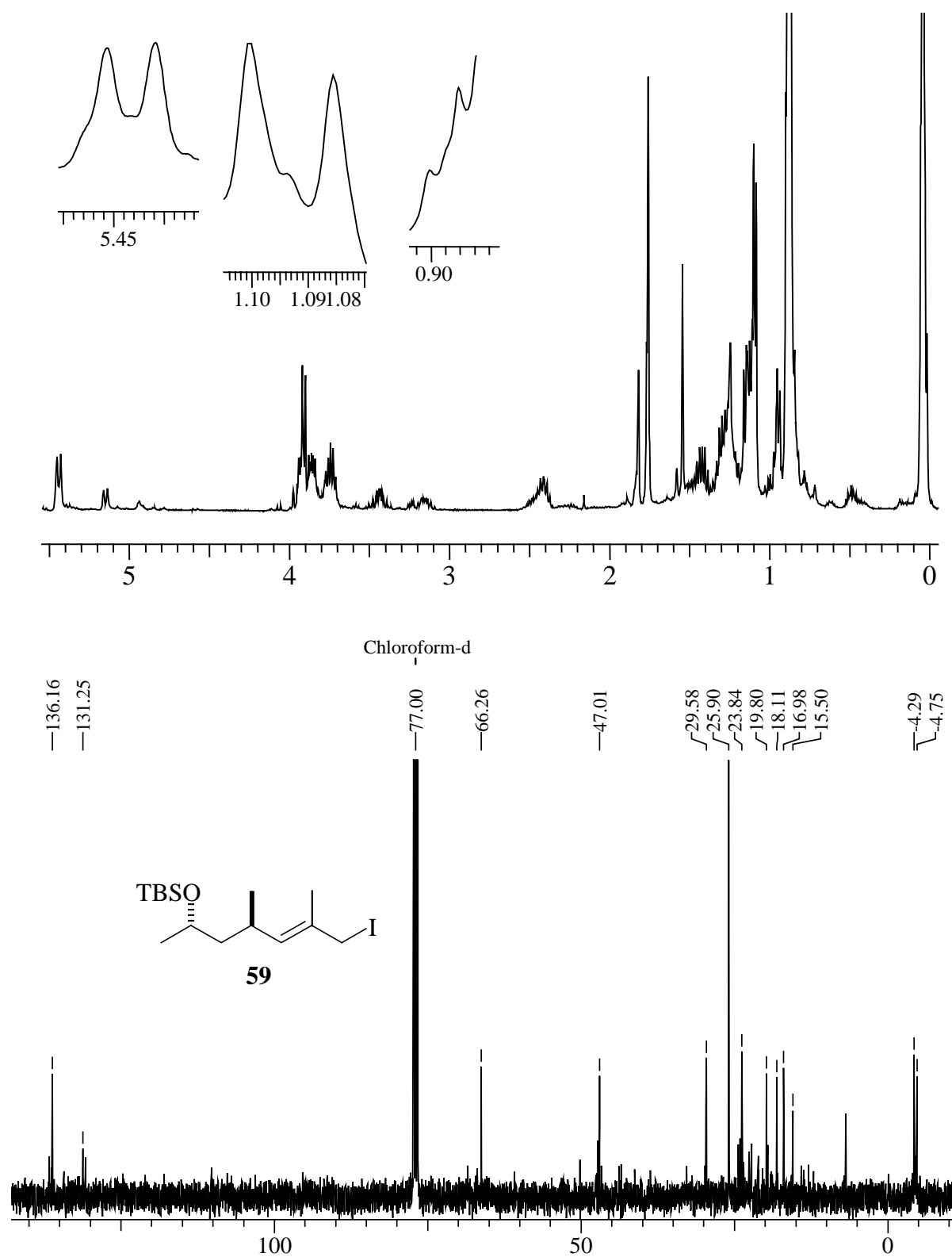

^1H - and ^{13}C -NMR spectra of compound **59**.

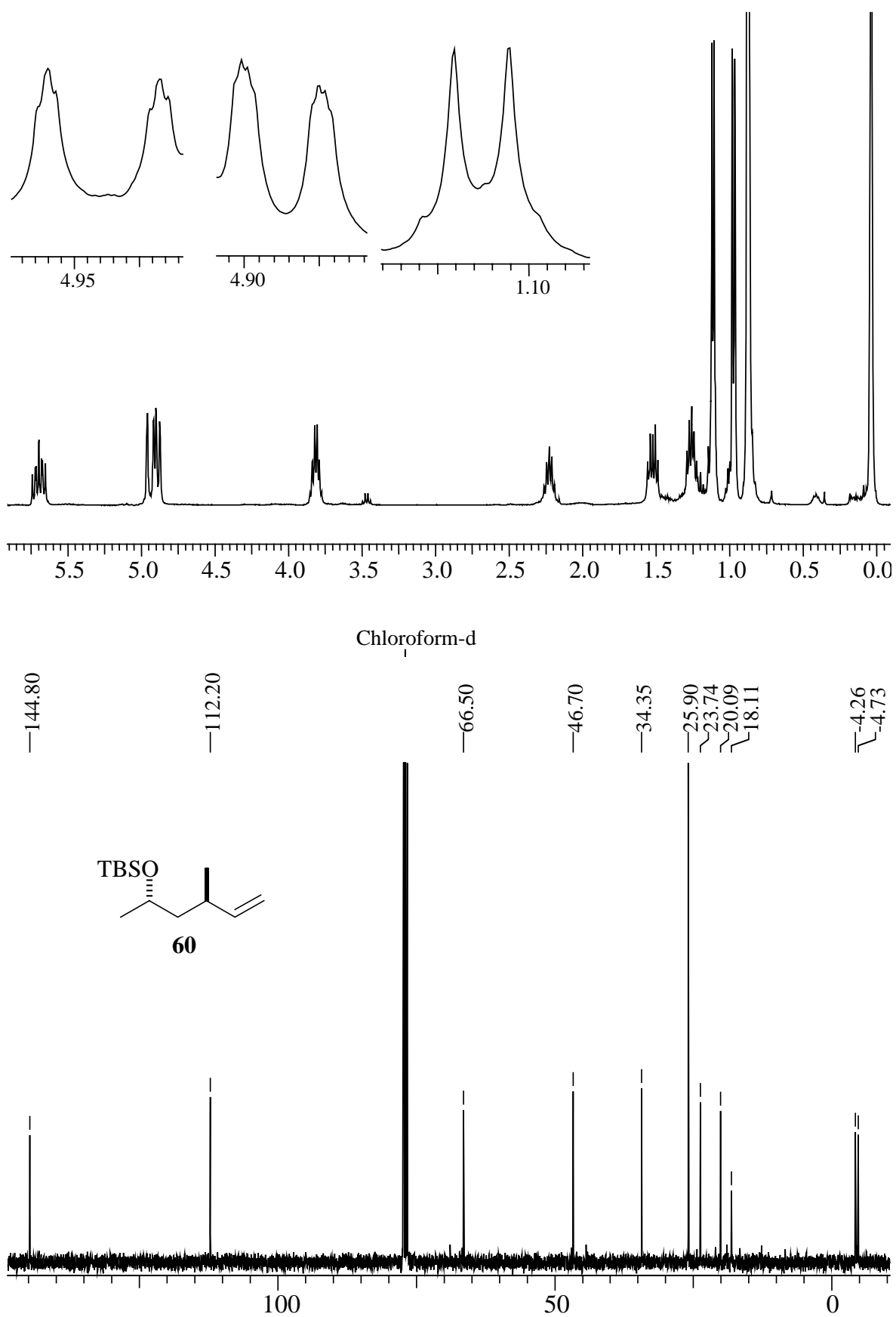

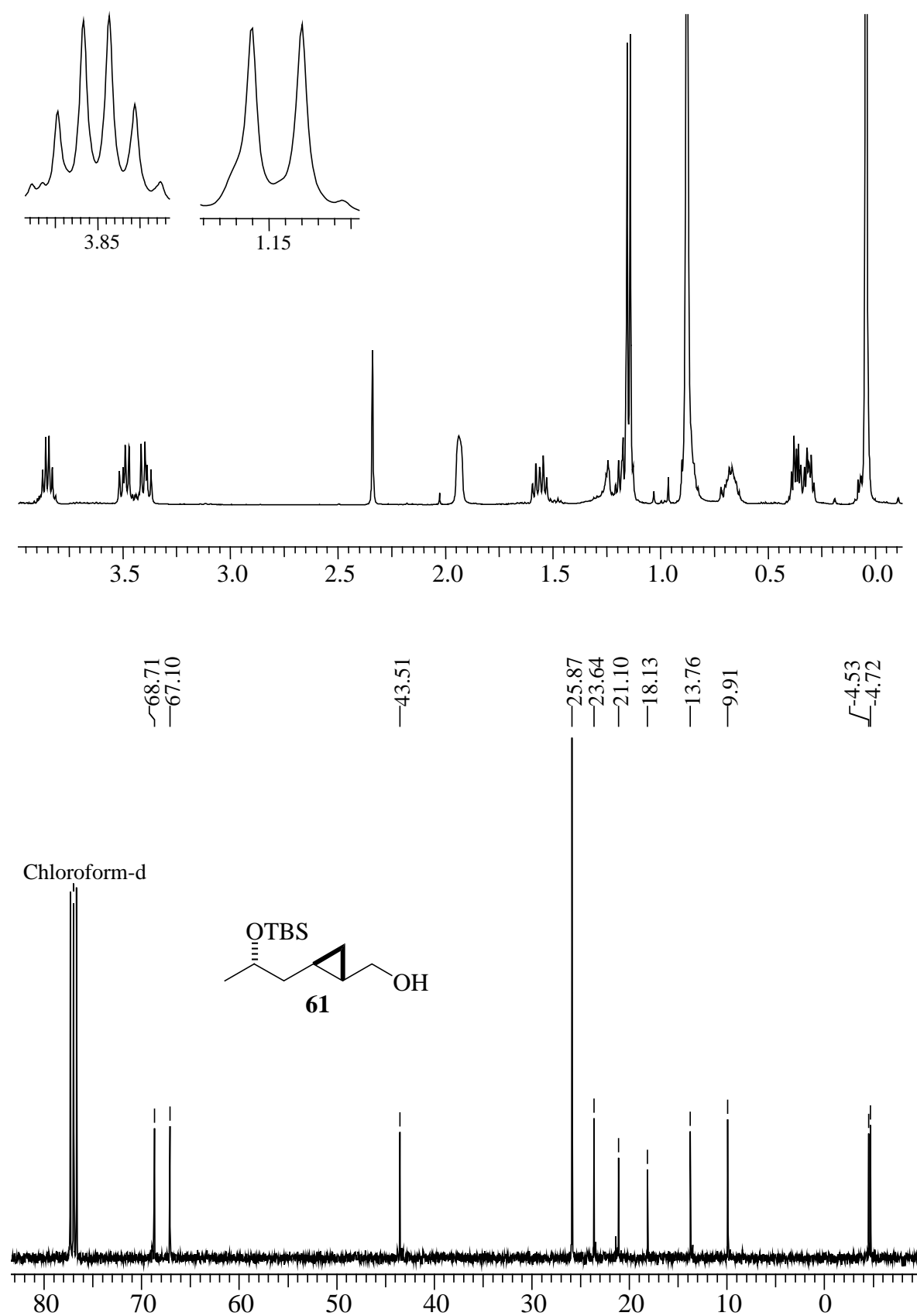

^1H - and ^{13}C -NMR spectra of compound **61**.

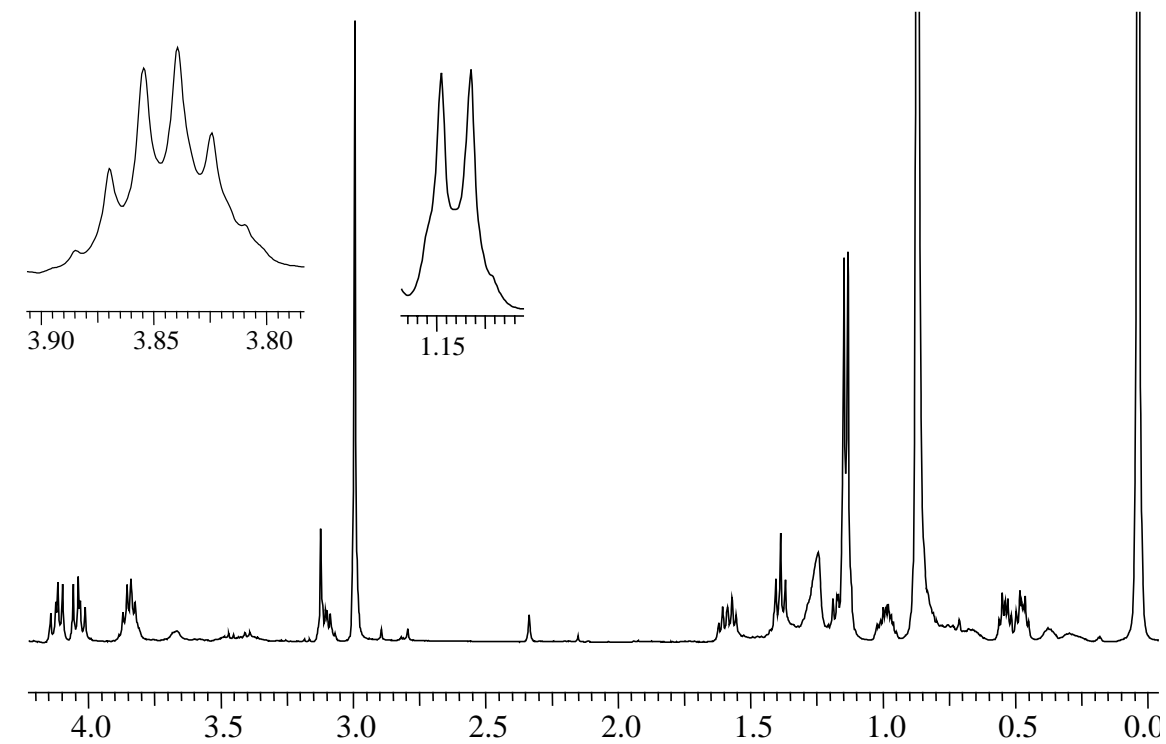

Chloroform-d

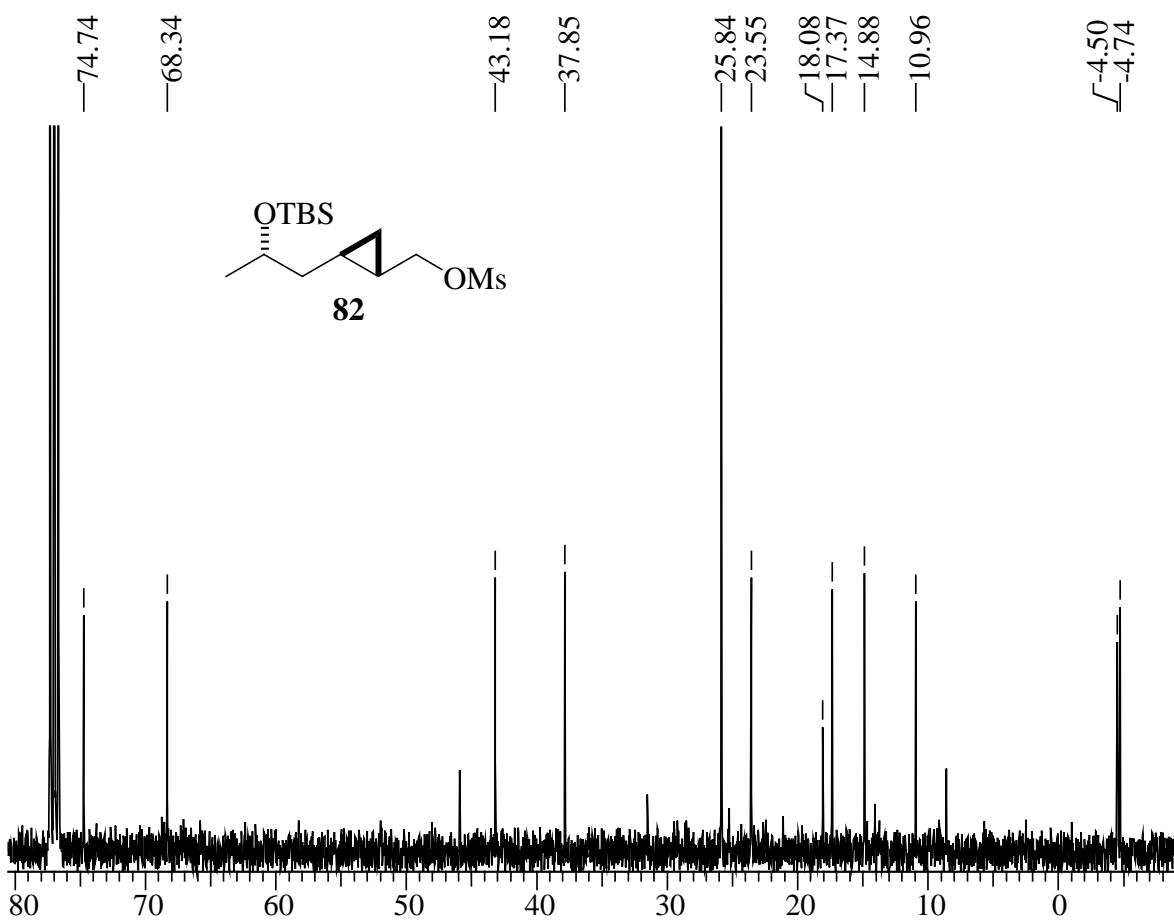
 ^1H - and ^{13}C -NMR spectra of compound **82**.

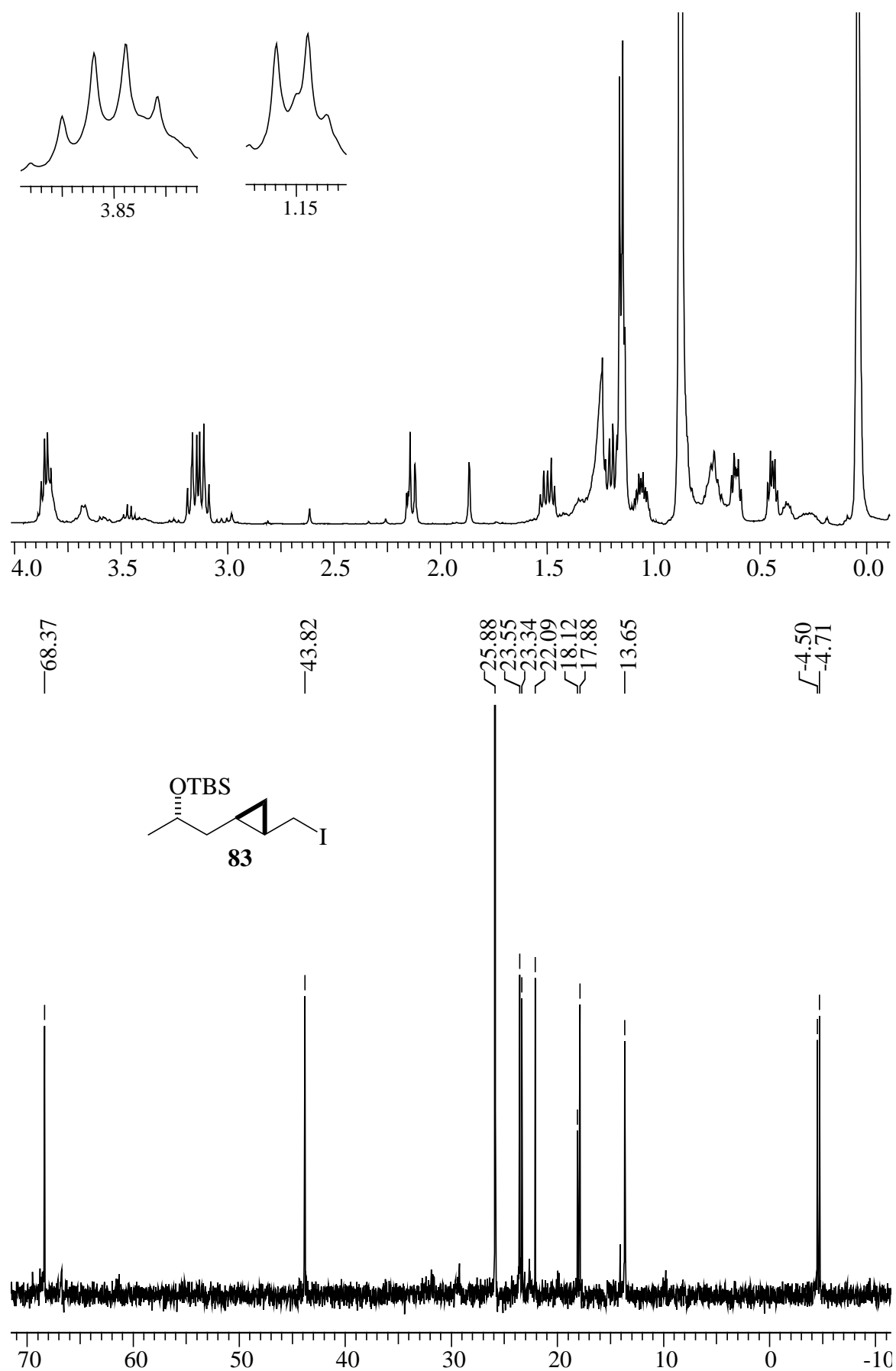

^1H - and ^{13}C -NMR spectra of compound **83**.

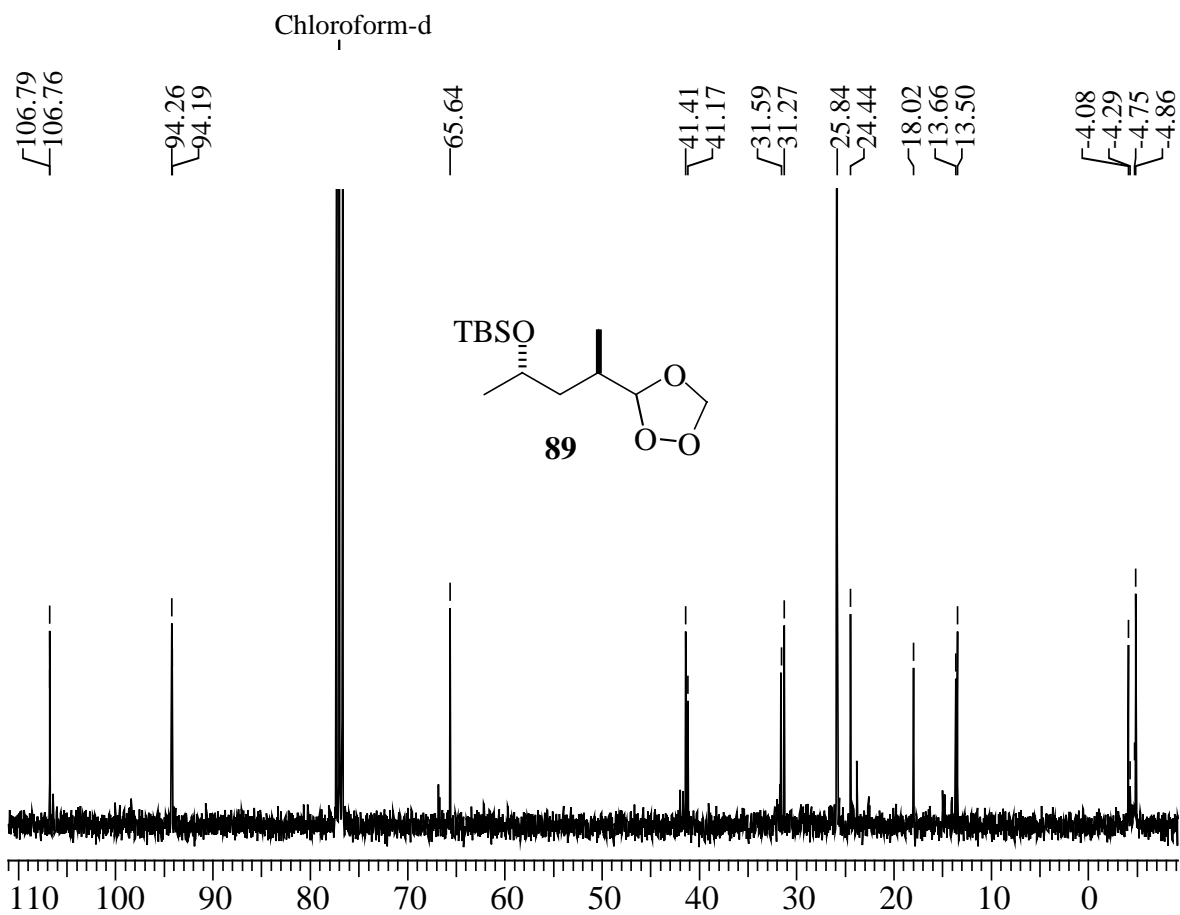
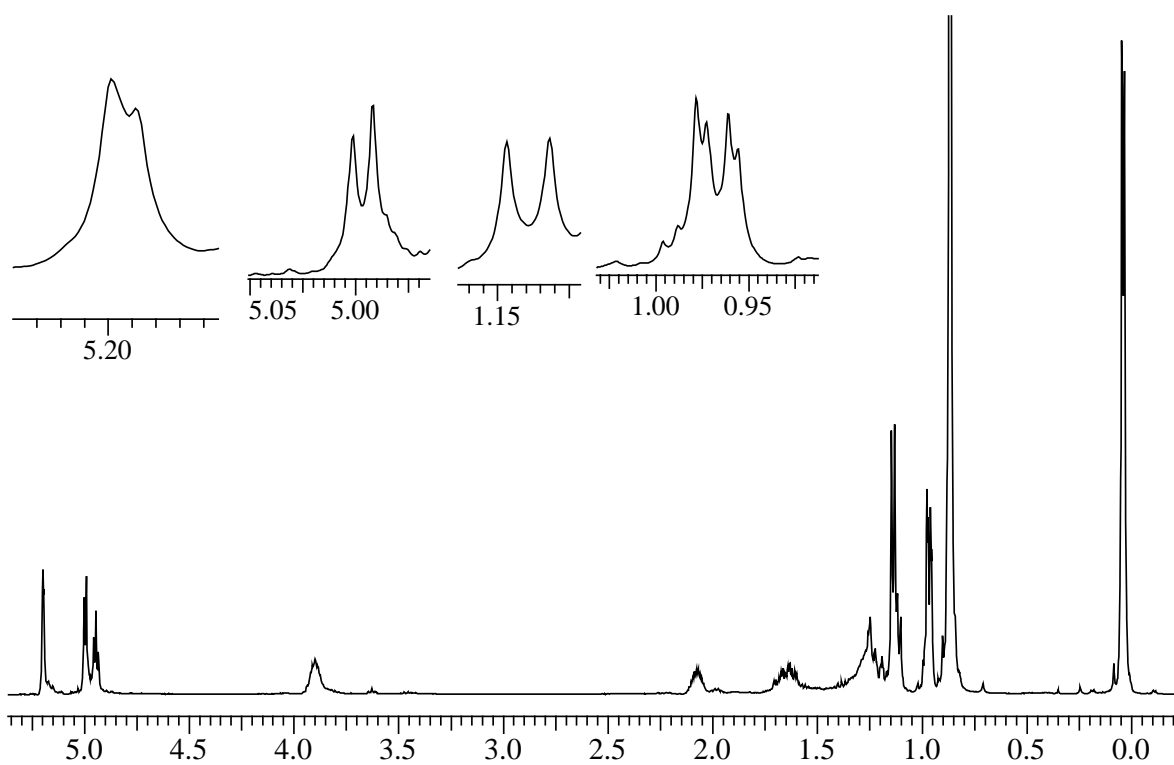

^1H - and ^{13}C -NMR spectra of compound **89**.

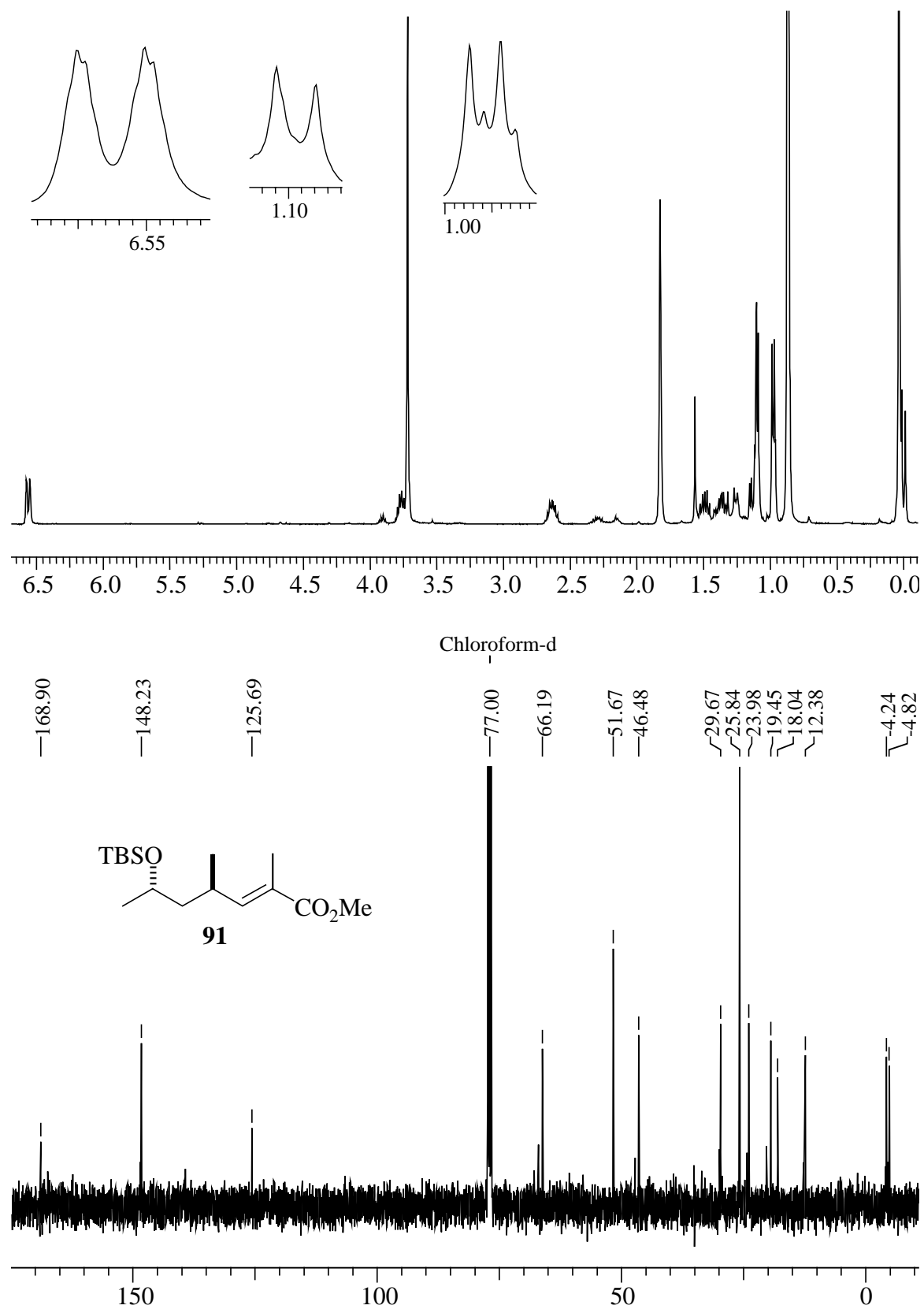

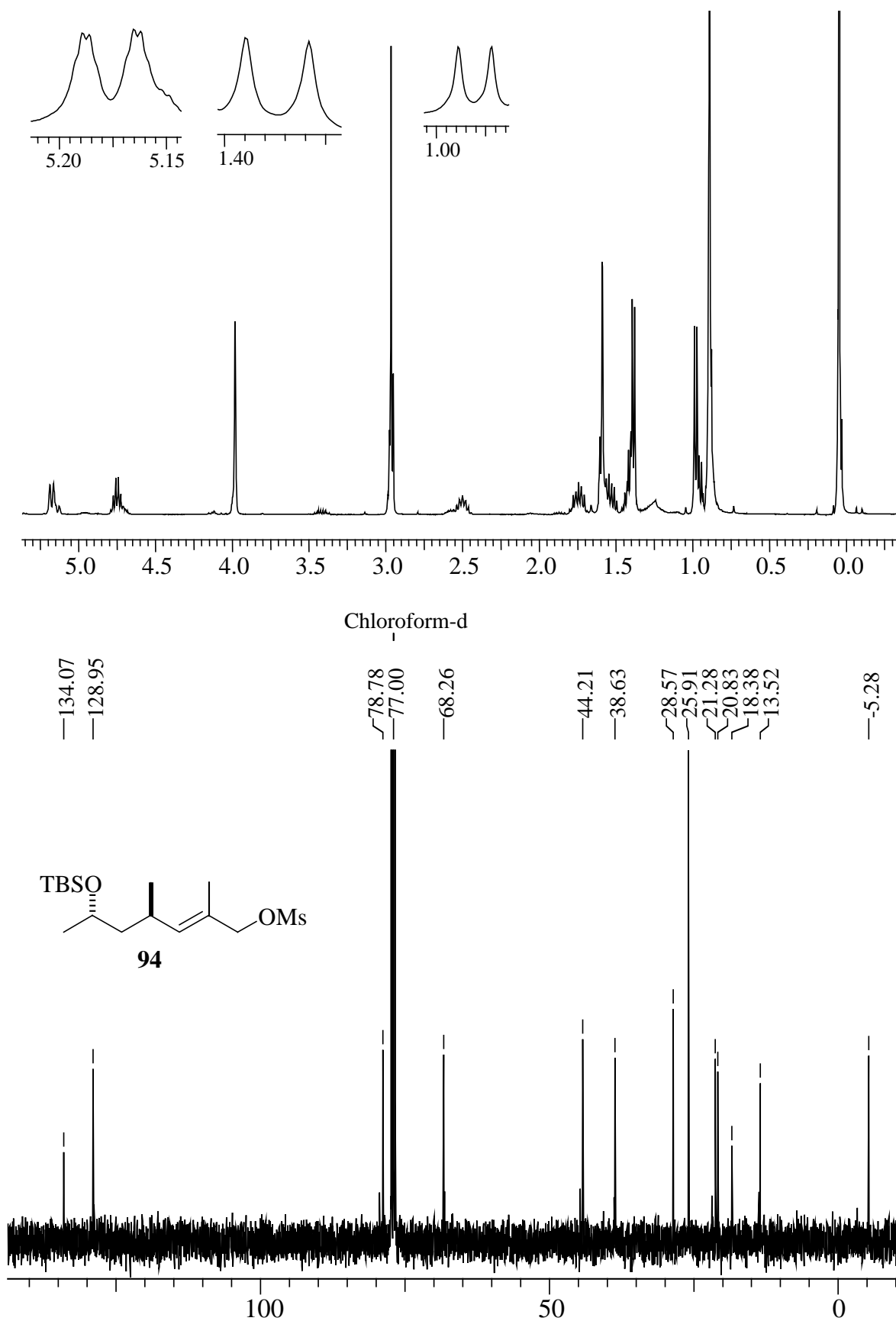

^1H - and ^{13}C -NMR spectra of compound **94**.

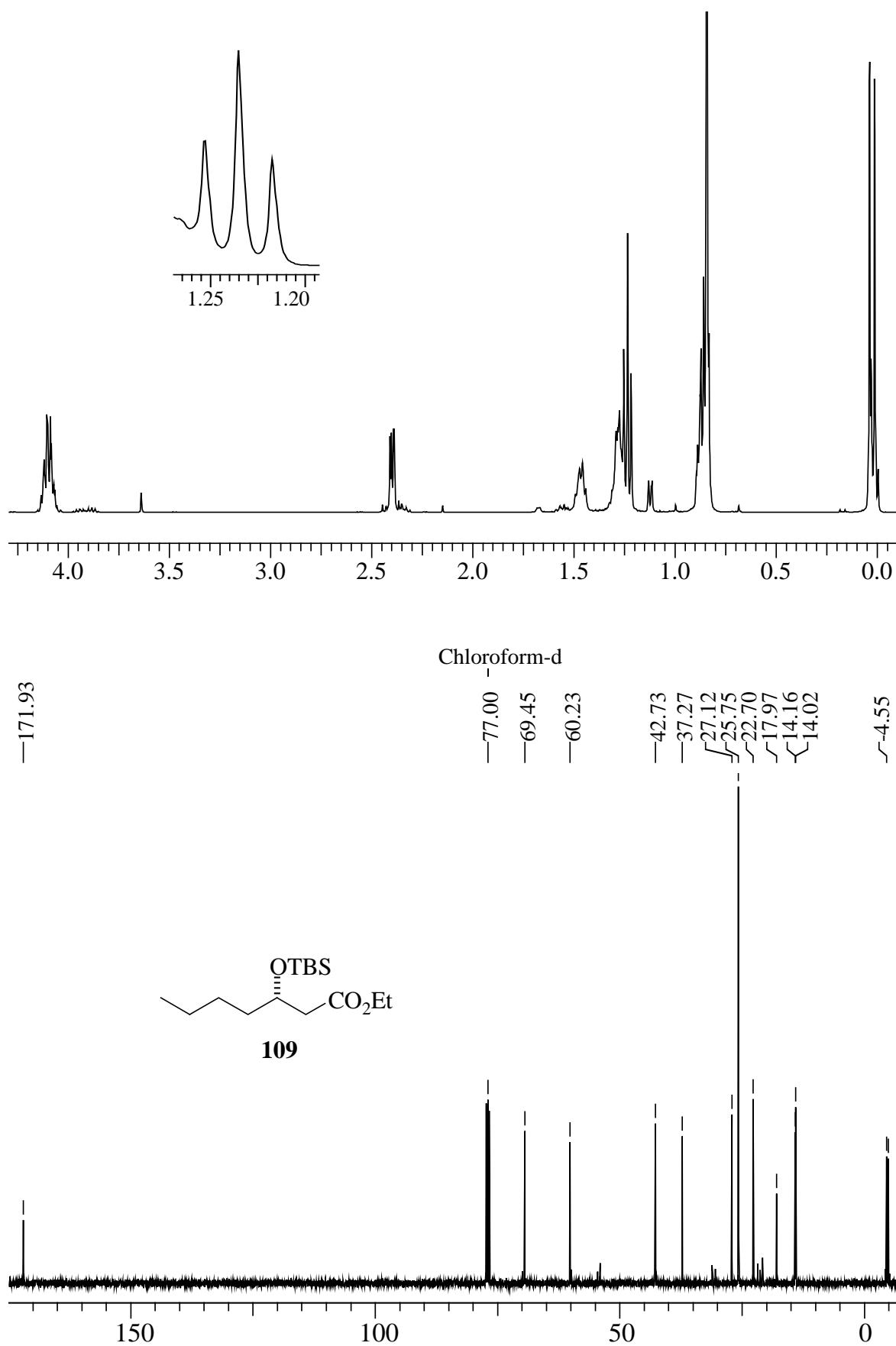

^1H - and ^{13}C -NMR spectra of compound **109**.

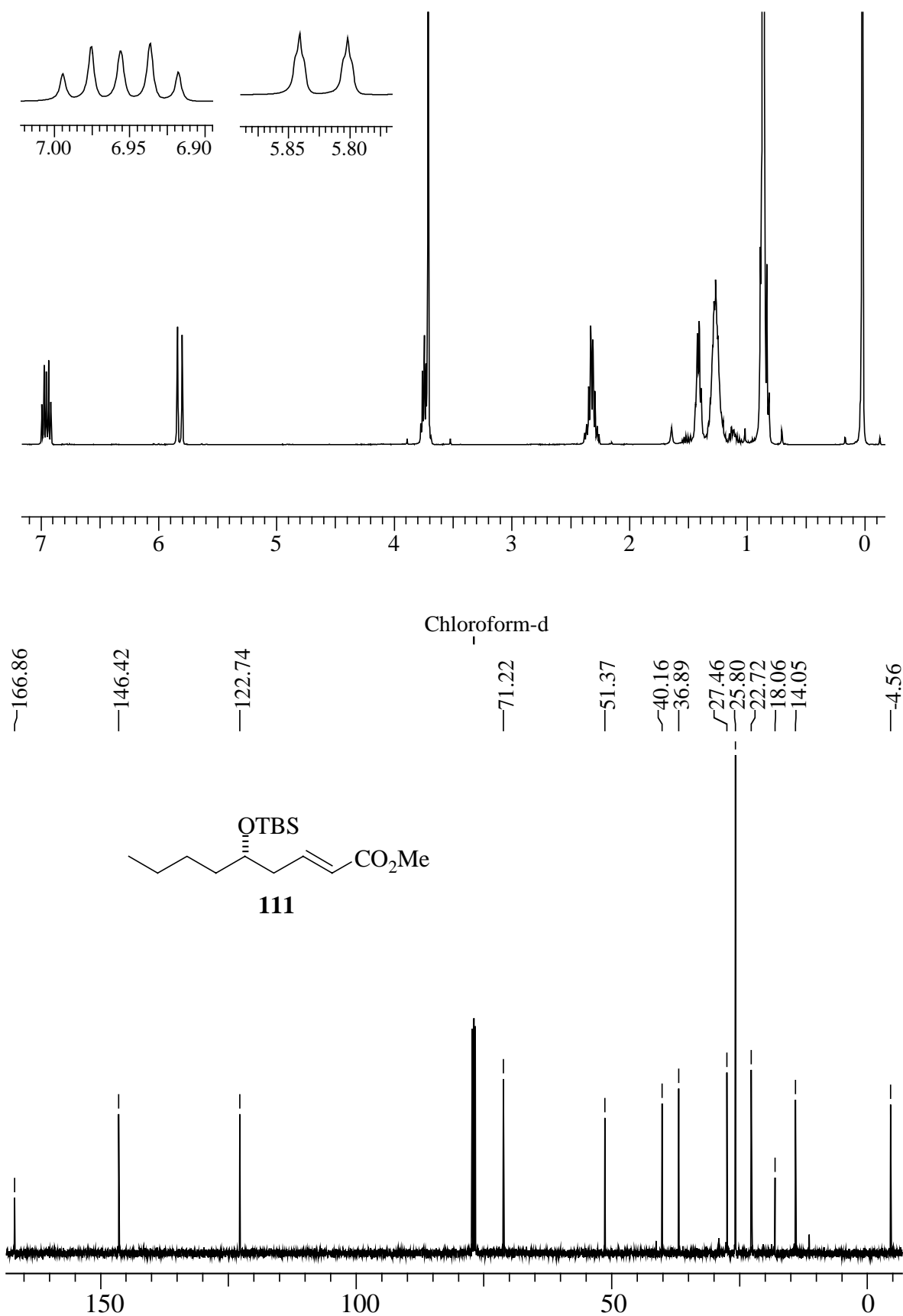

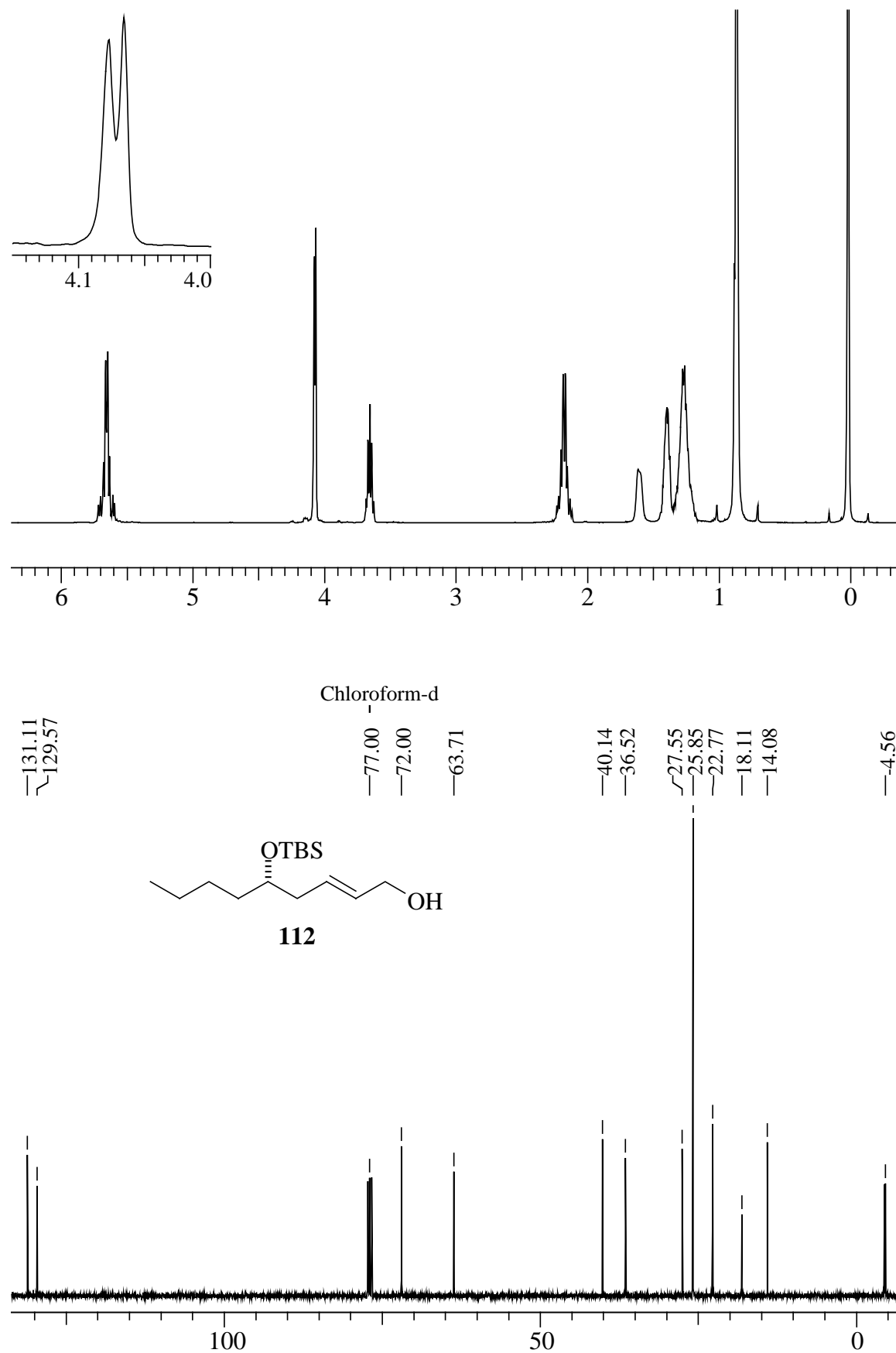

^1H - and ^{13}C -NMR spectra of compound **112**.

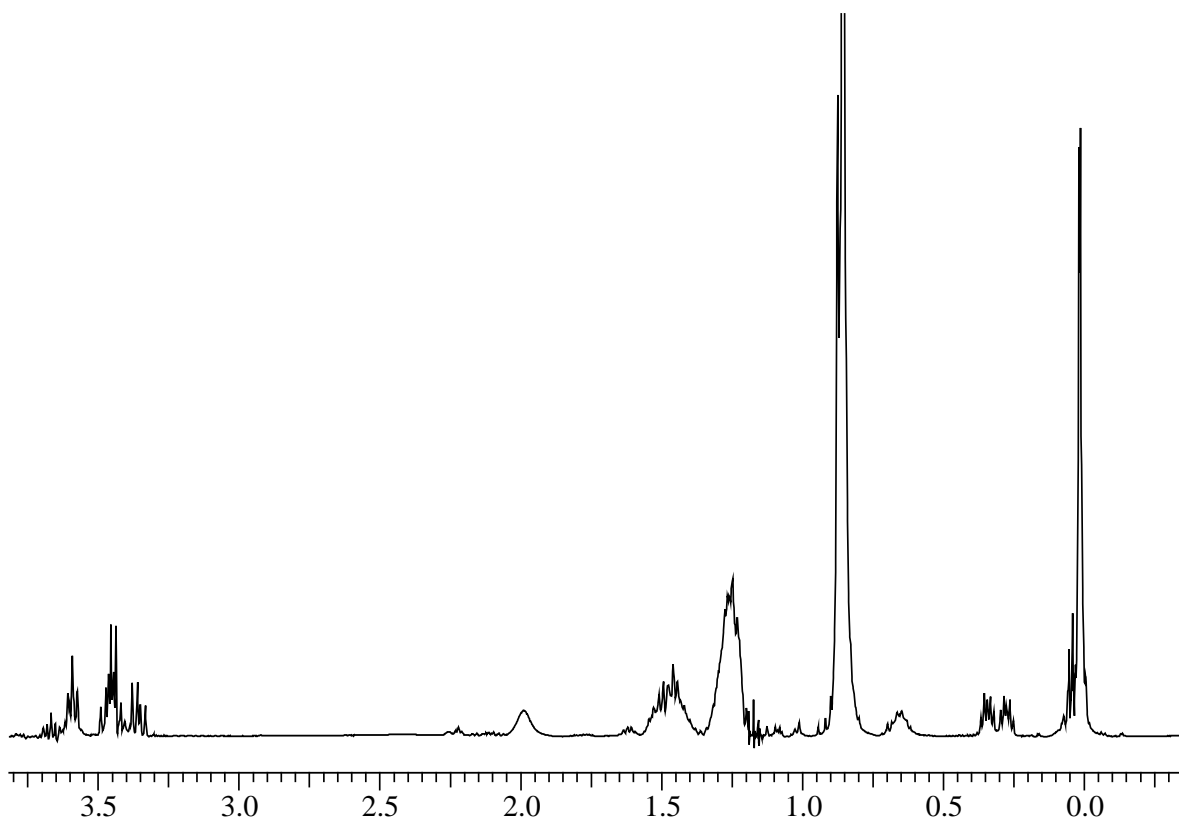

Chloroform-d

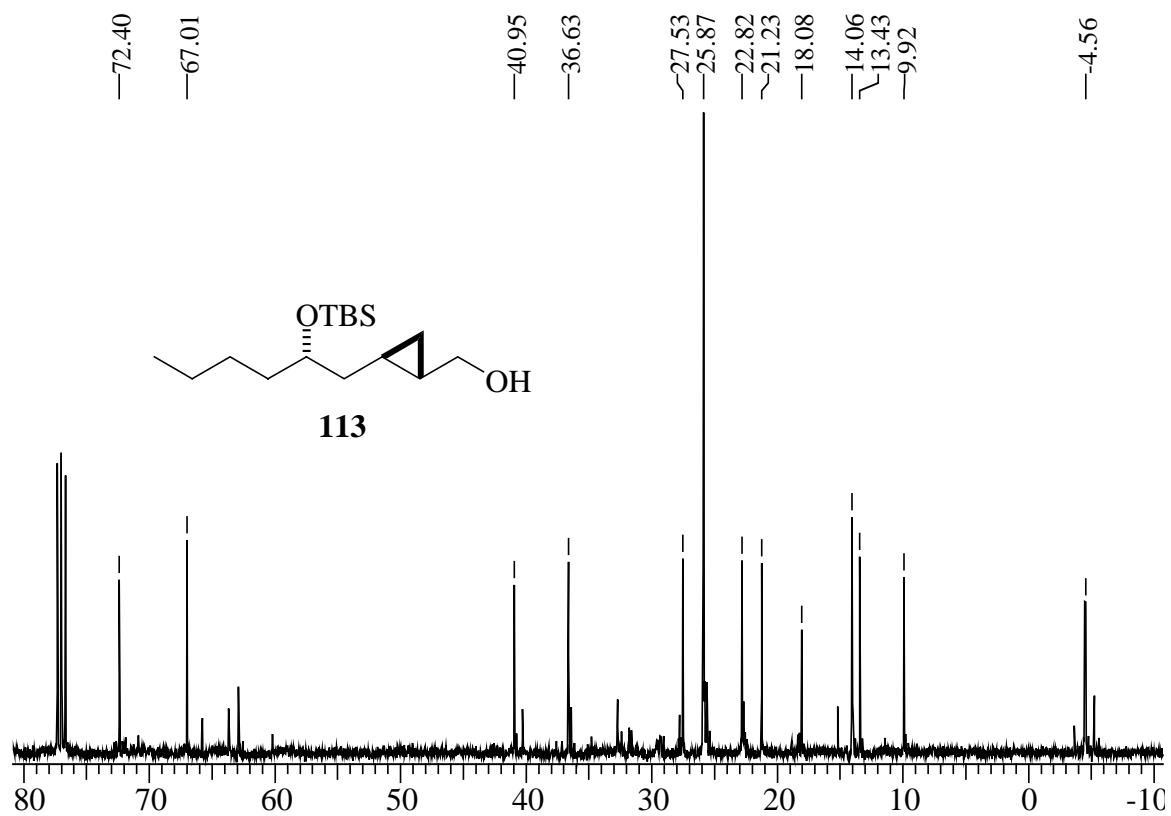

^1H - and ^{13}C -NMR spectra of compound **113**.

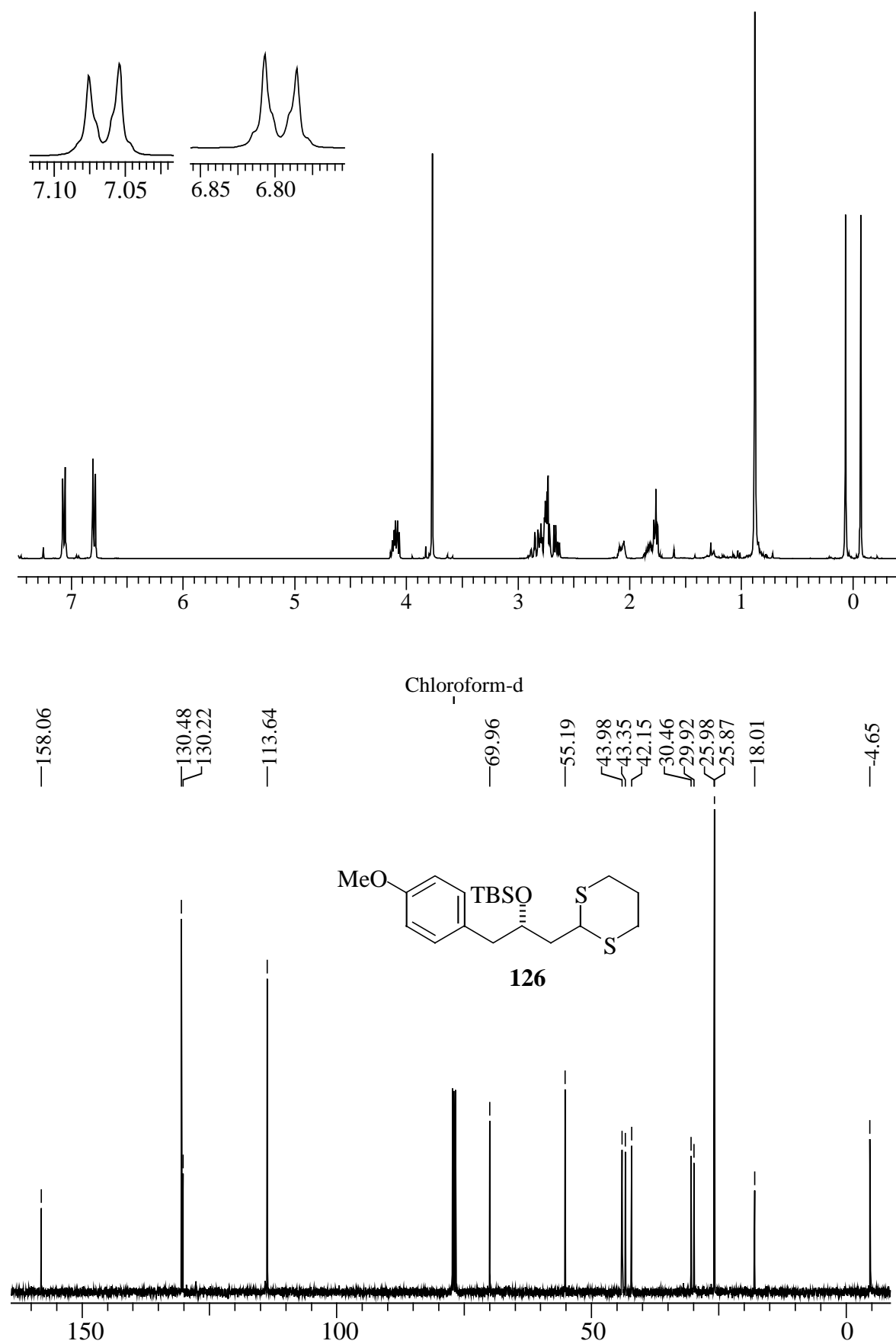

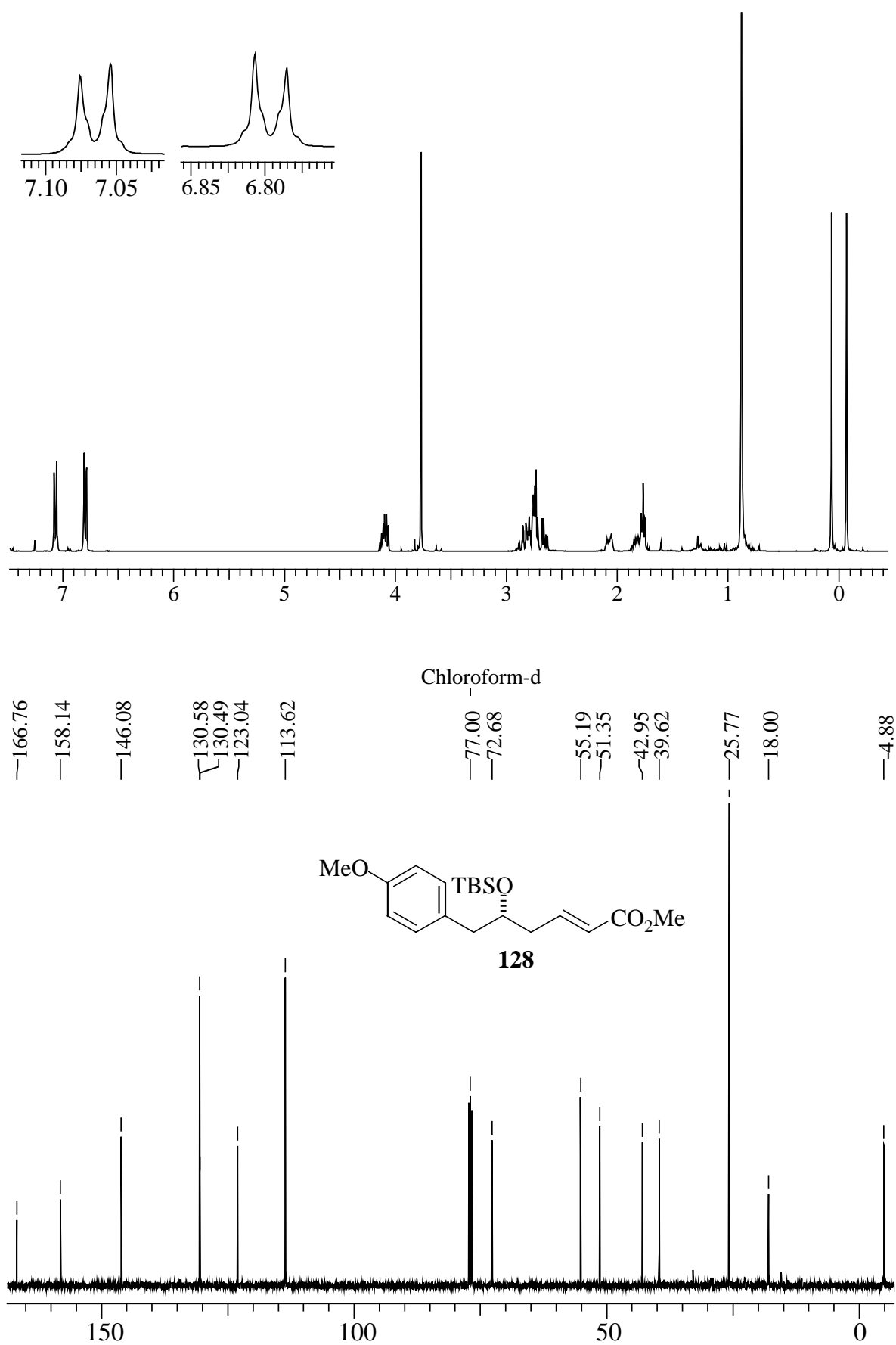

^1H - and ^{13}C -NMR spectra of compound **128**.

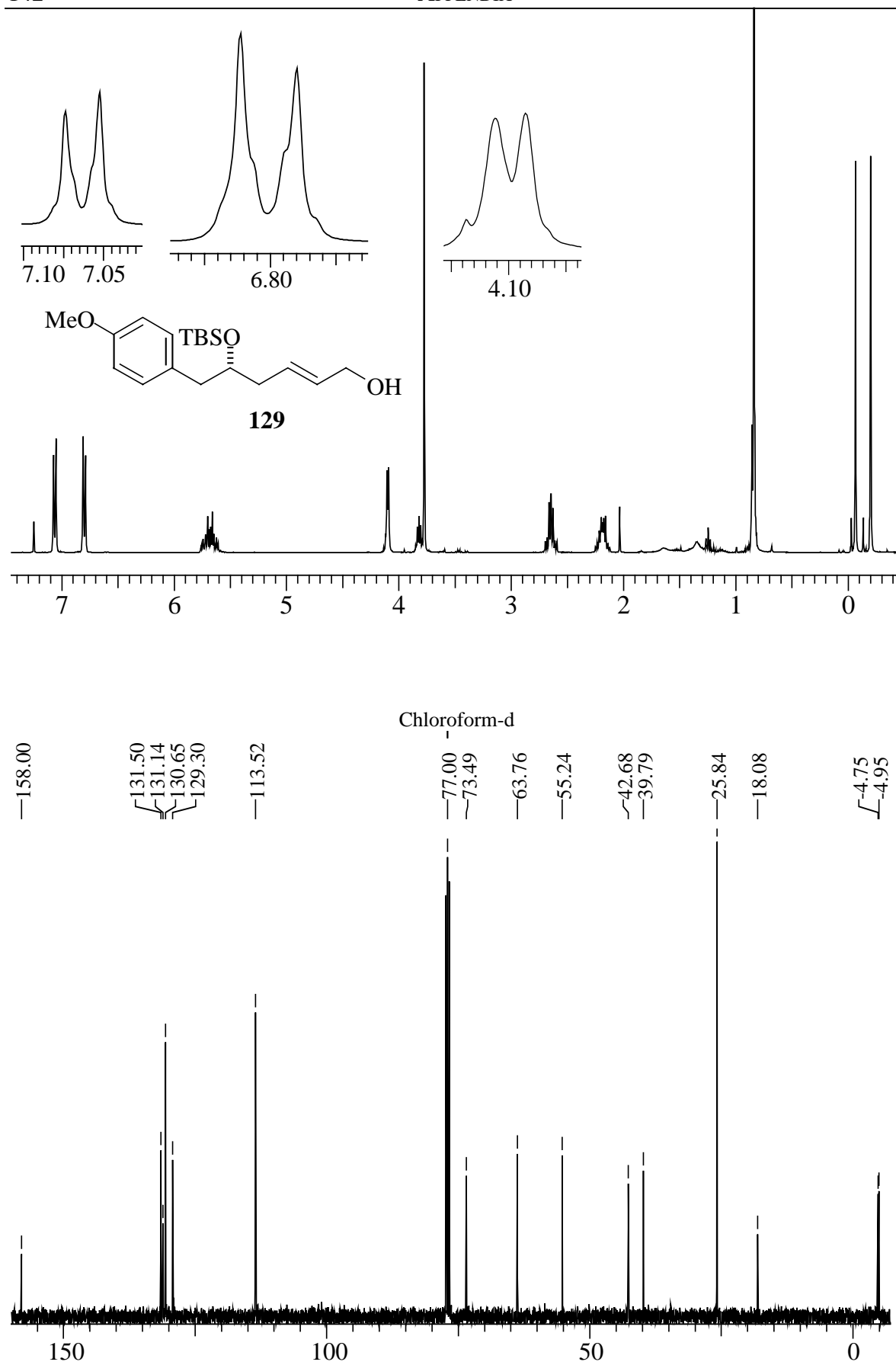

$^1\text{H-}$ and $^{13}\text{C-NMR}$ spectra of compound **129**.

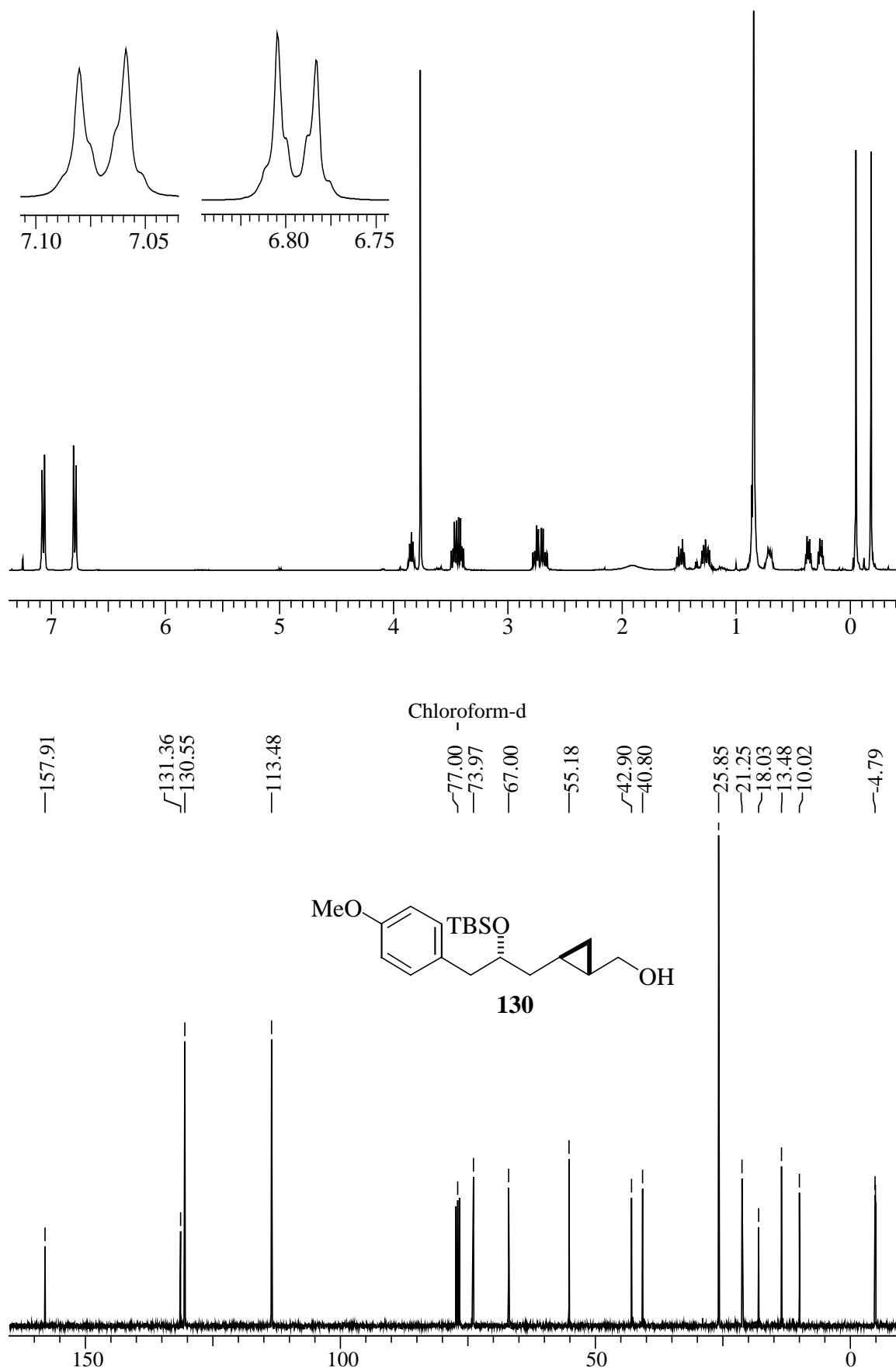

^1H - and ^{13}C -NMR spectra of compound **130**.

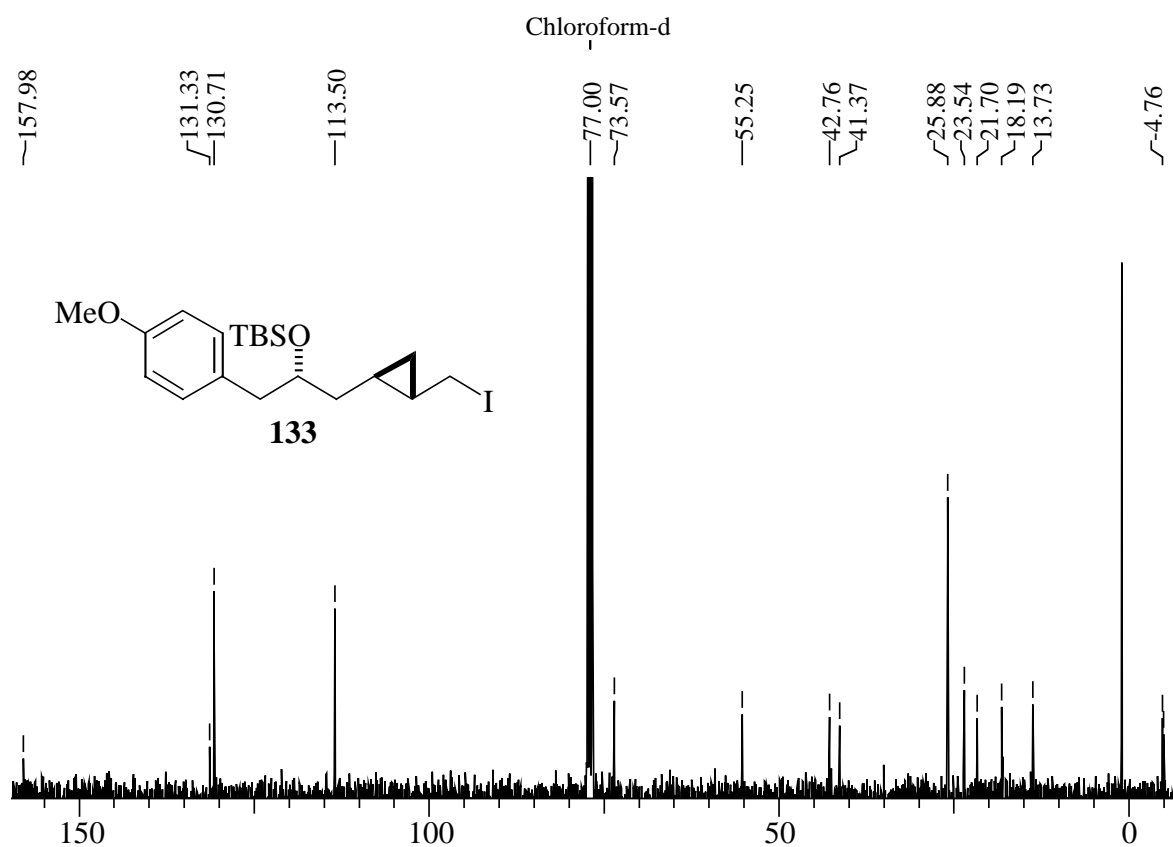
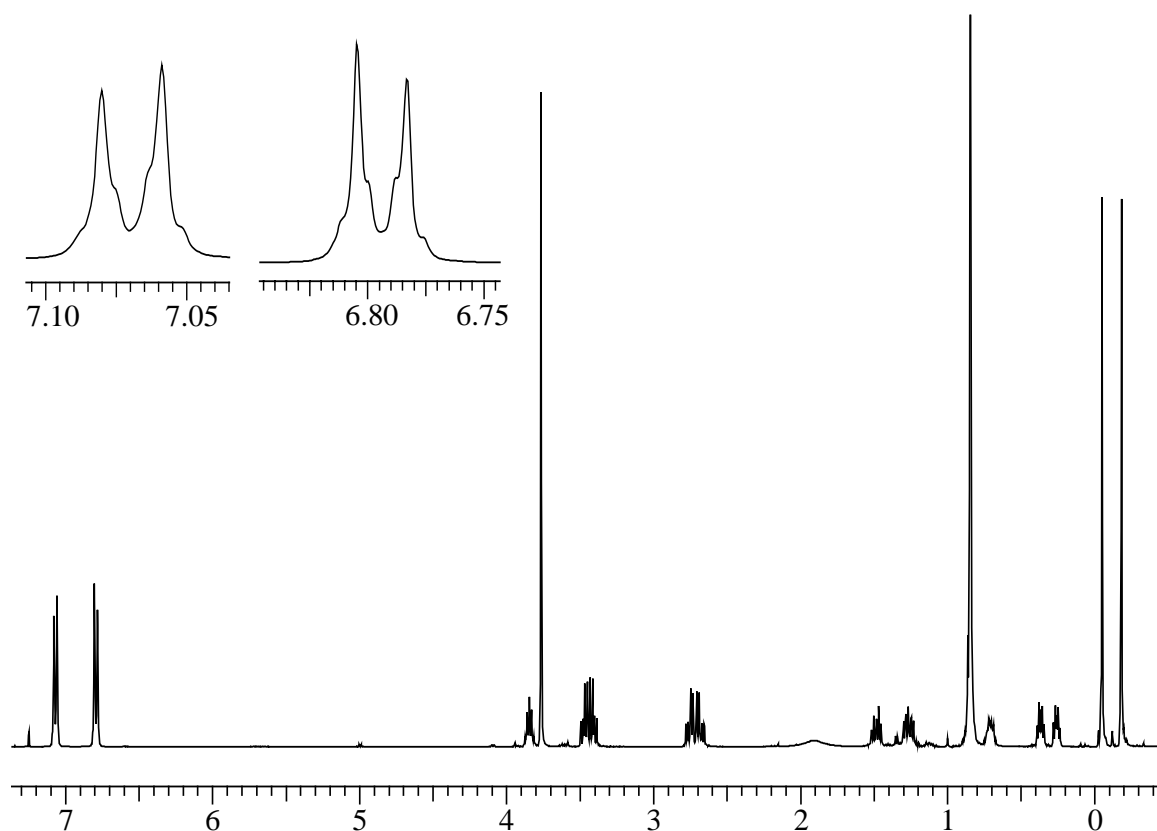

^1H - and ^{13}C -NMR spectra of compound **133**.

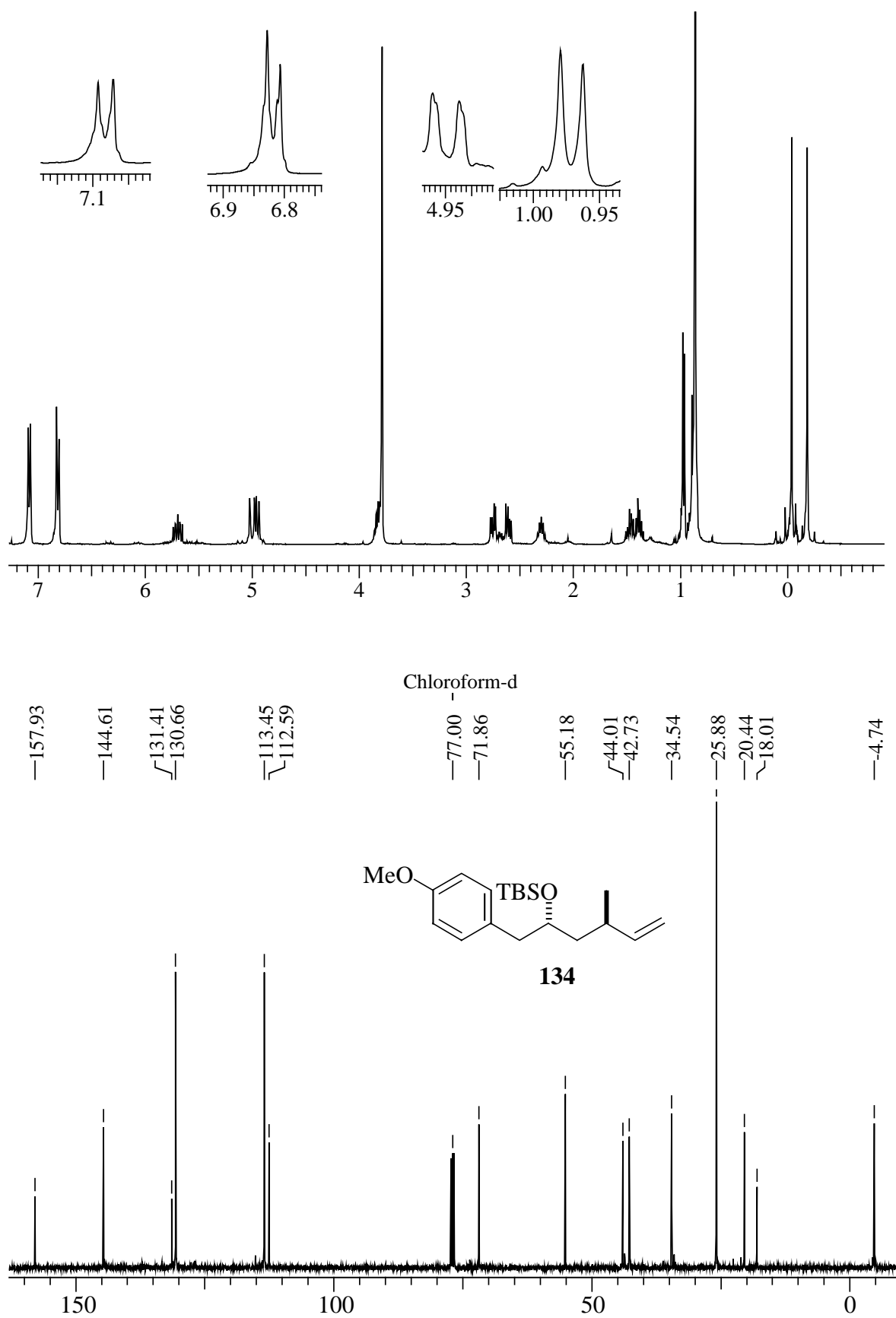

¹H- and ¹³C-NMR spectra of compound **134**.

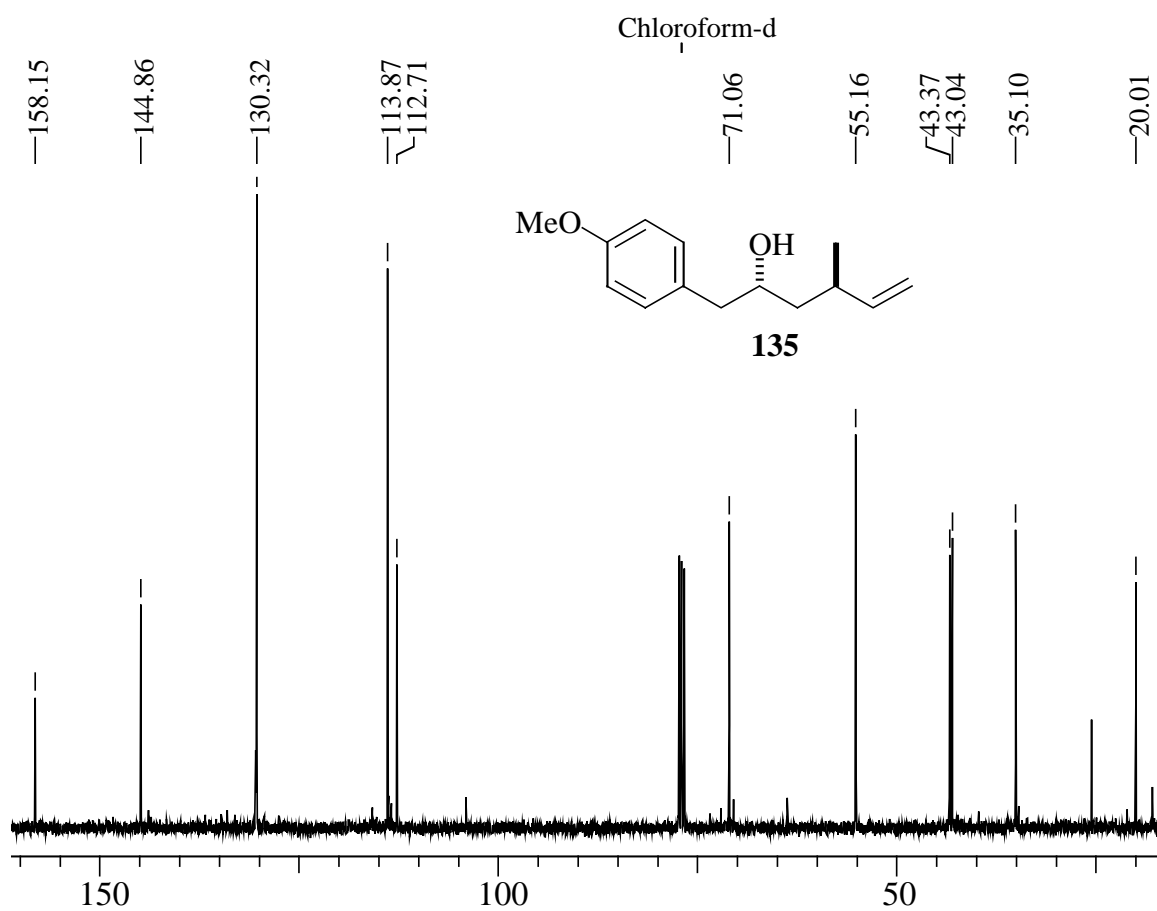
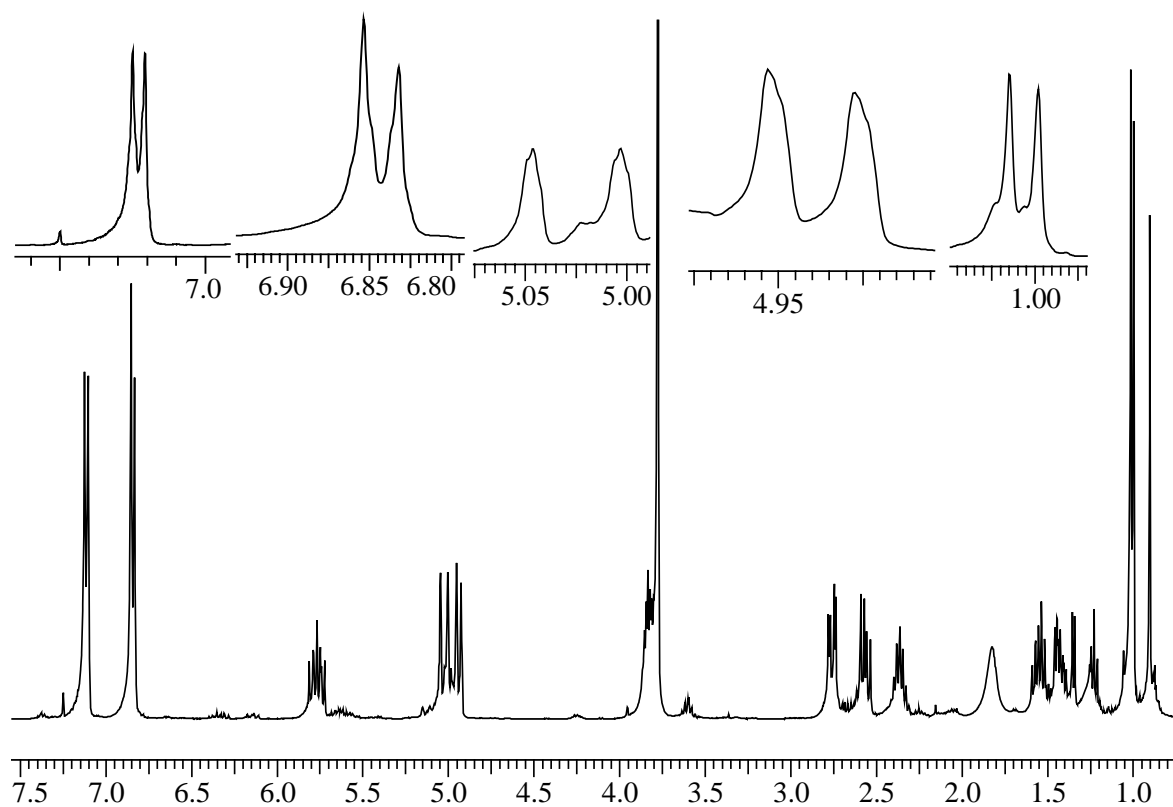

$^1\text{H-}$ and $^{13}\text{C-NMR}$ spectra of compound **135**.

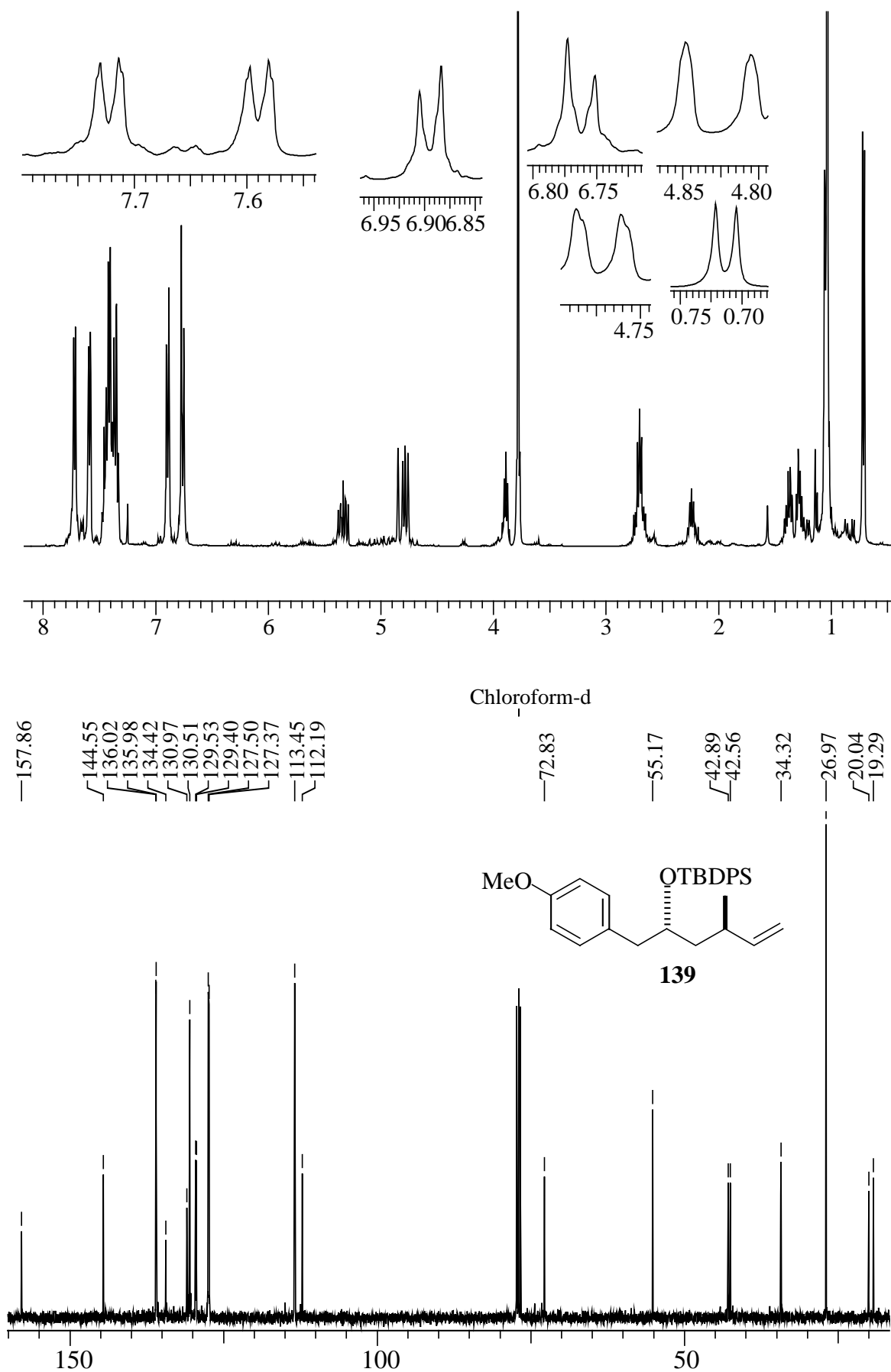

¹H- and ¹³C-NMR spectra of compound **139**.

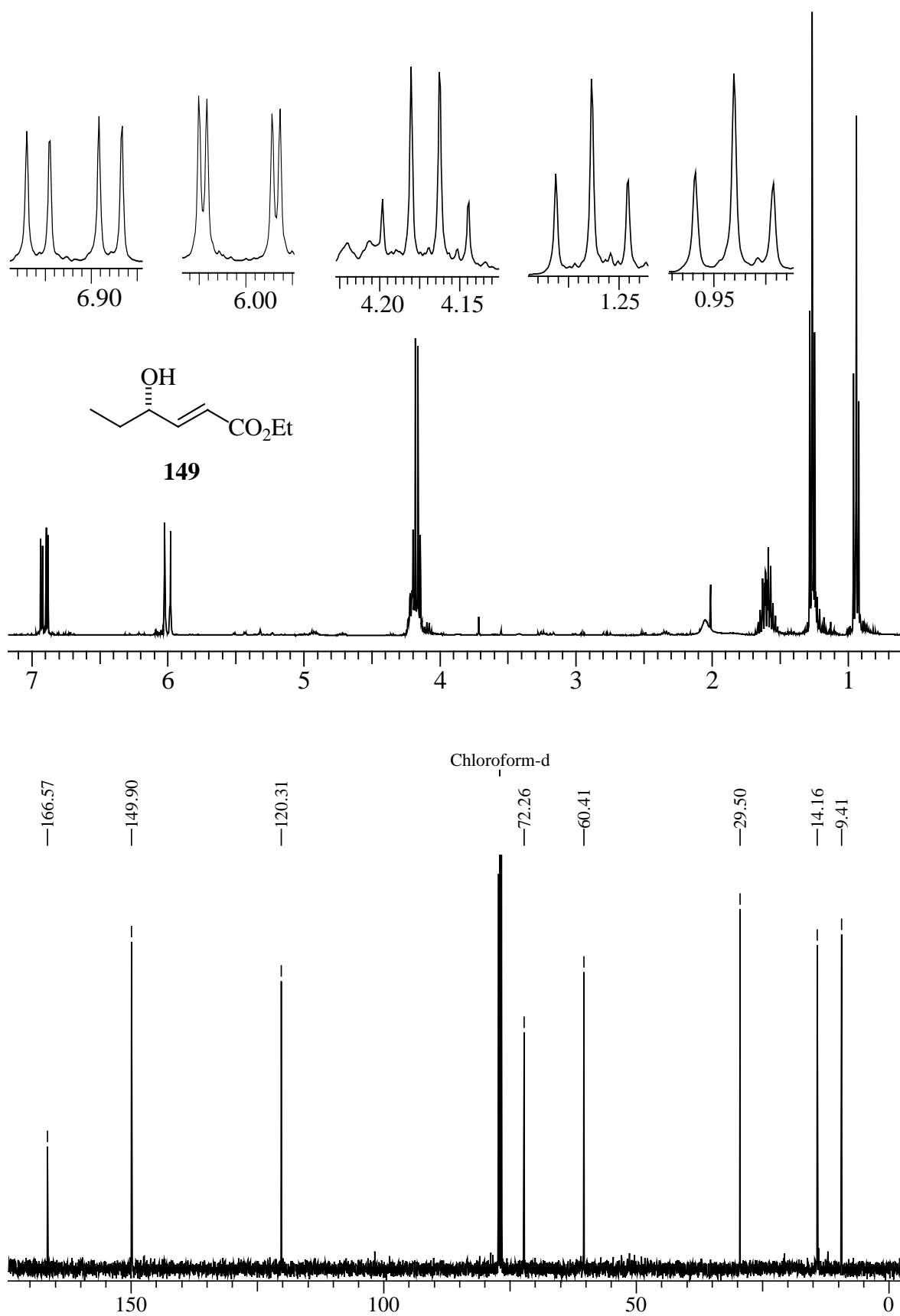

^1H - and ^{13}C -NMR spectra of compound **149**.

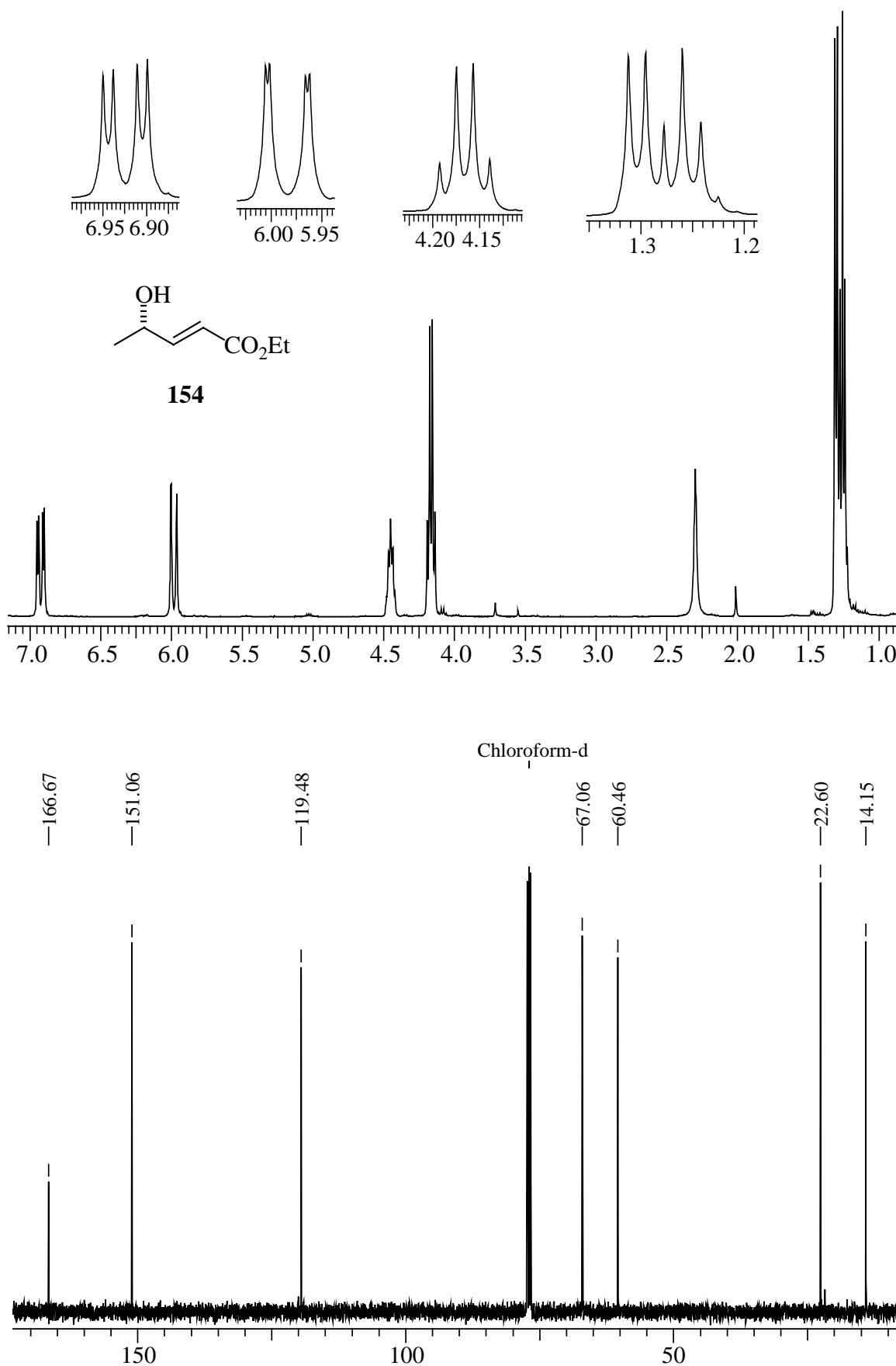

^1H - and ^{13}C -NMR spectra of compound **154**.

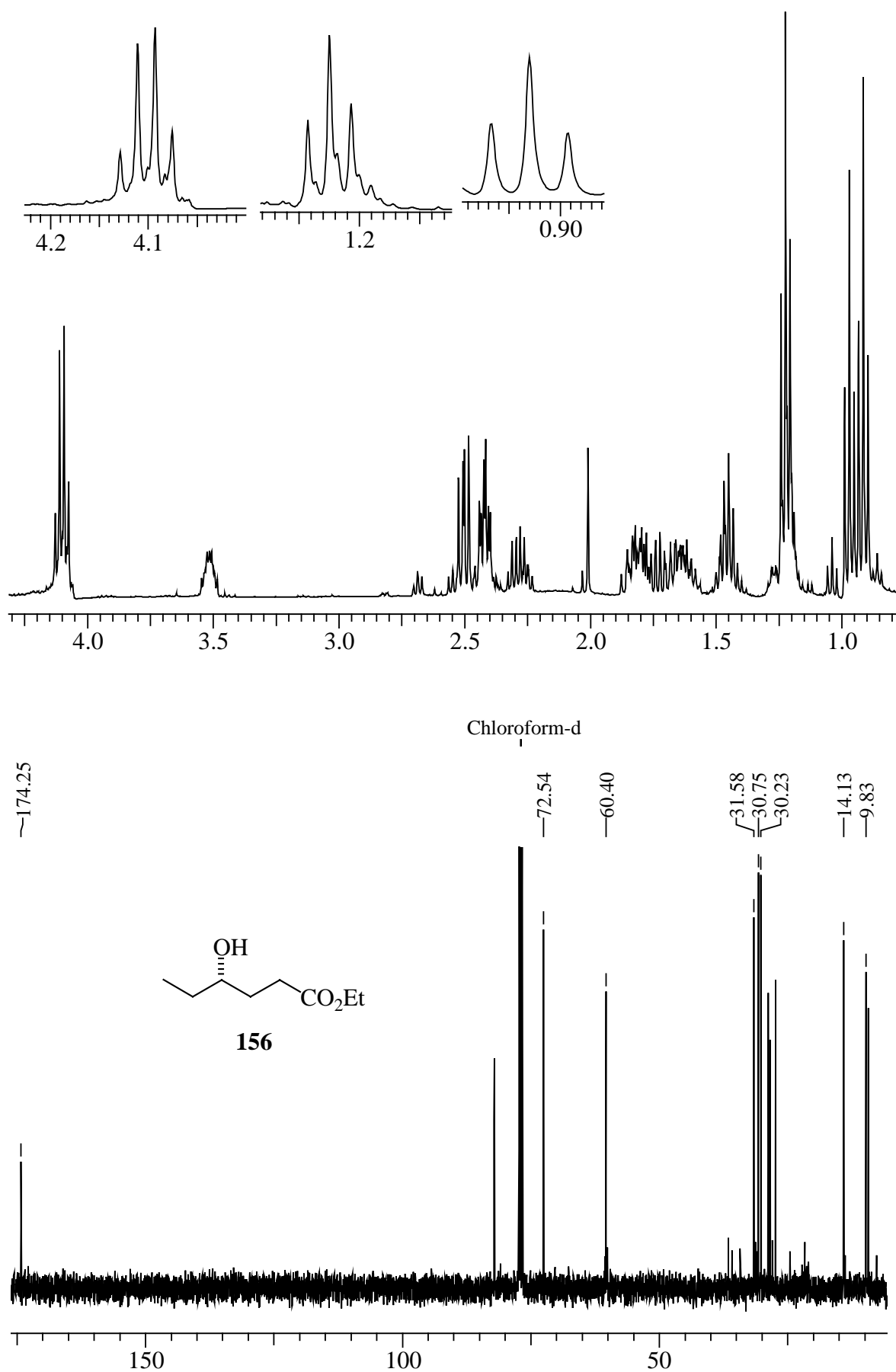

^1H - and ^{13}C -NMR spectra of compound **156**.

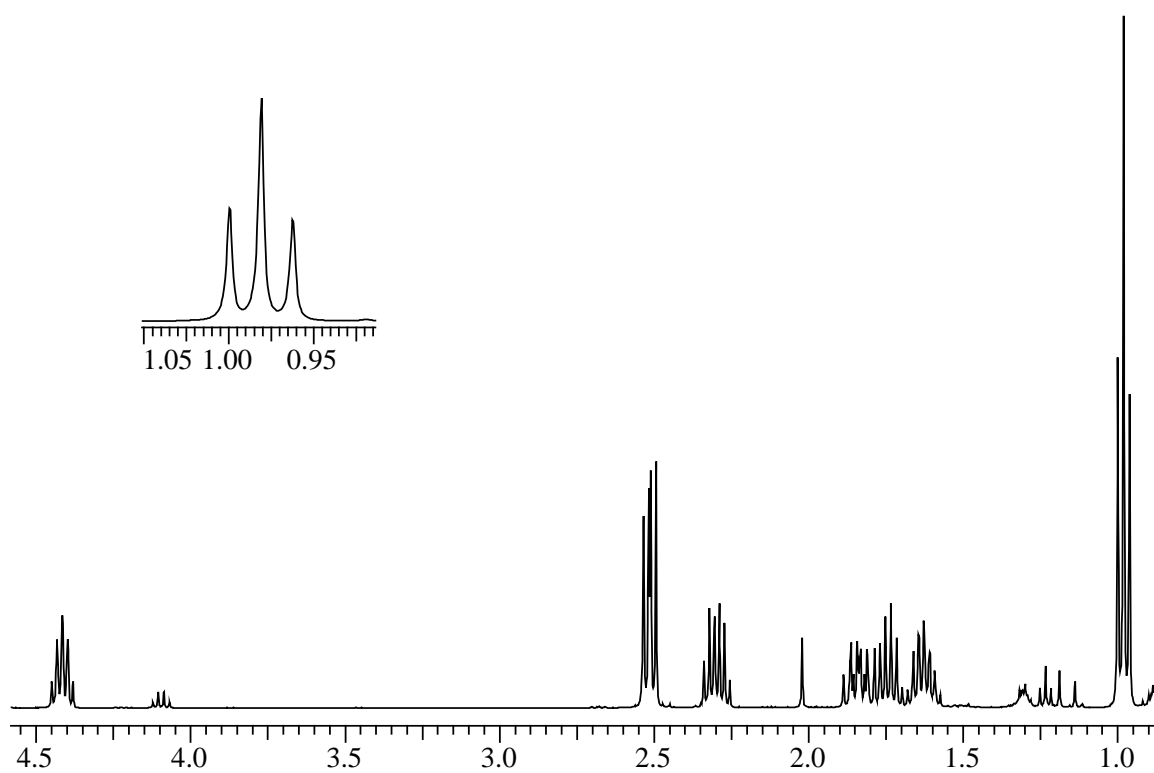

Chloroform-d

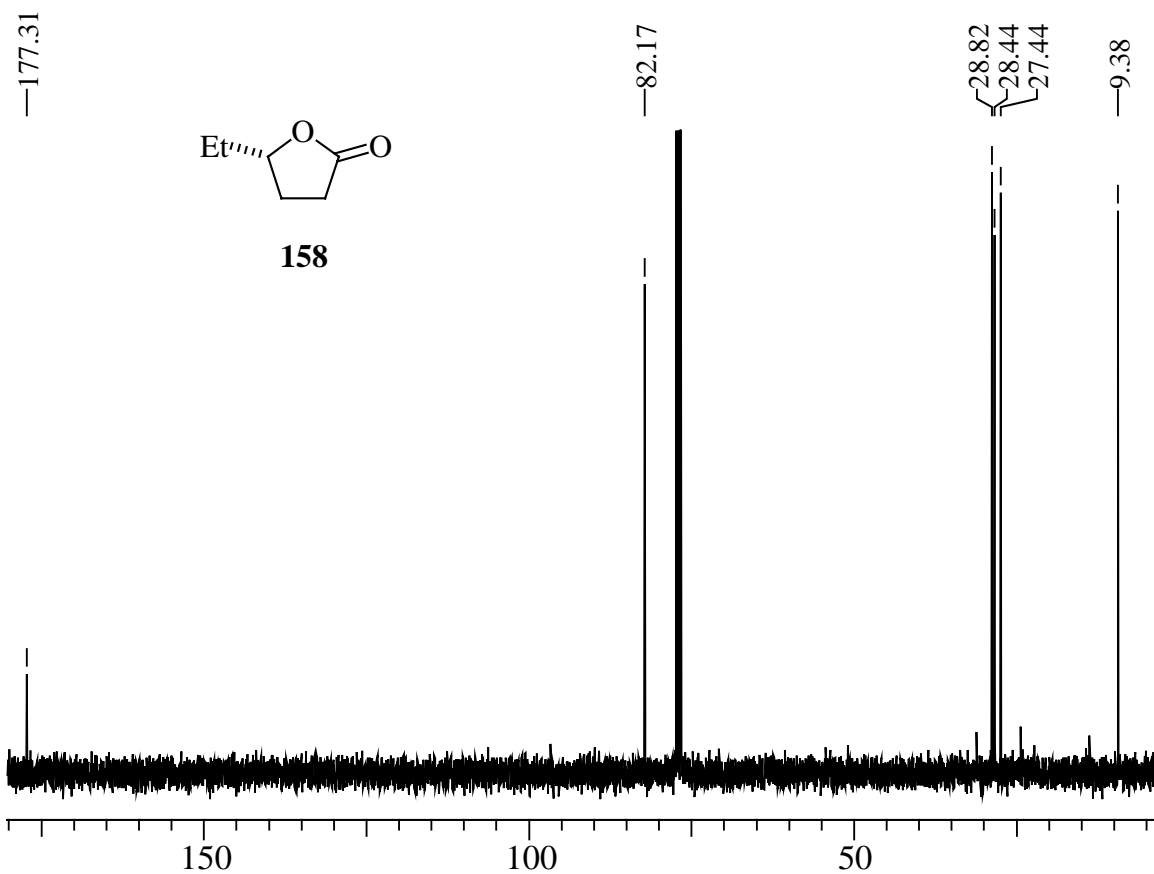
 ^1H - and ^{13}C -NMR spectra of compound **158**.

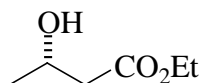
Ethyl (3*R*)-3-hydroxybutanoate (63)**GC:**

Device: HP 5890 Gas Chromatograph, Series II

Column: Chirasil Val (Glas Capillary), 20 m x 0.3 mm

Conditions: Pressure 48 kPa H₂

Temperatureprogram: From 60 °C (3 min) 3.5 °C/min to 175 °C

Derivative: Iso-propylurethane

Peak	Retention Time	Area	Area %	ee %
1	14.81	13724	5.282	89
2	14.99	246110	94.718	

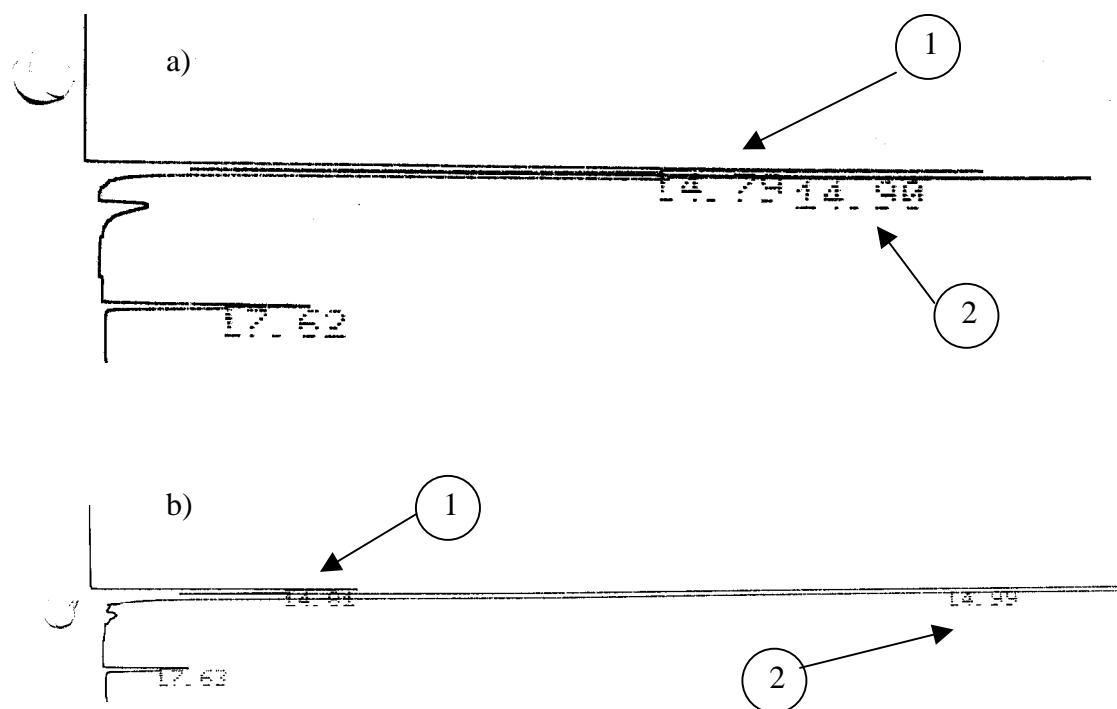
GC-Diagram: Derivatives of (a) racemic mixtures. (b) compound **63**.

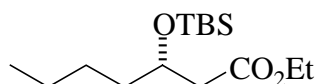
Ethyl (3S)-3-[[*tert*-butyl(dimethyl)silyl]oxy]heptanoate (109)**GC:**

Device: HP 5890 Gas Chromatograph, Series II

Column: Chirasil Val (Glas Capillary), 20 m x 0.3 mm

Conditions: Pressure 48 kPa H₂

Temperatureprogram: From 70 °C (3 min) 3.5 °C/min to 180 °C

Derivative: Iso-propylurethane

Peak	Retention Time	Area	Area %	ee %
1 ^a	20.40	753	3.871	92
2 ^a	20.62	18700	96.129	
3	20.97	564	3.406	93
4	21.13	15993	96.594	

Note: a) The derivatization were not completed.

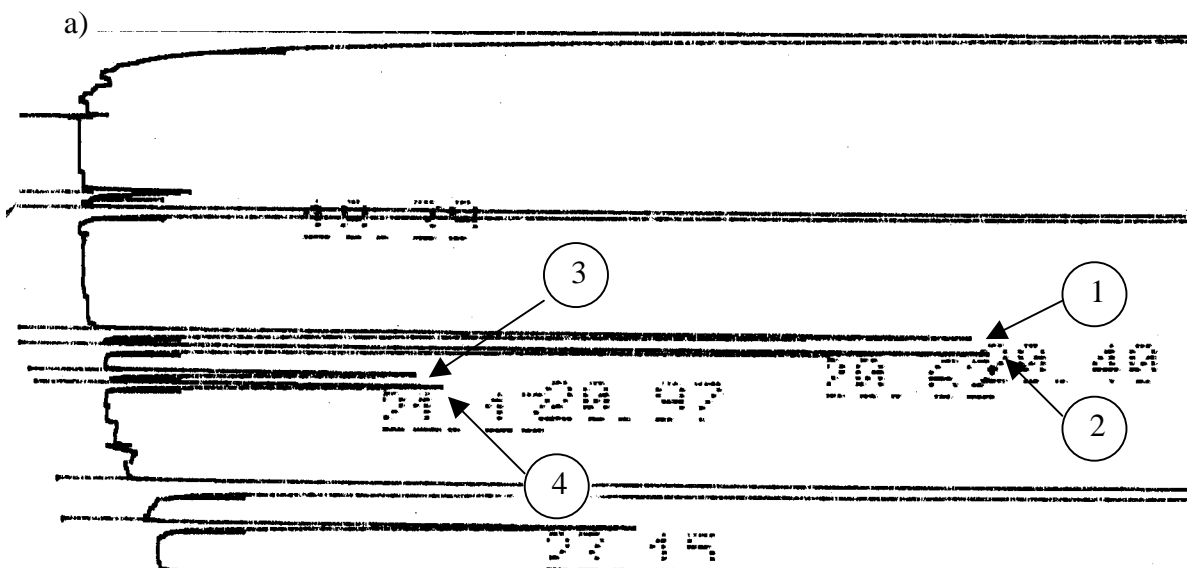

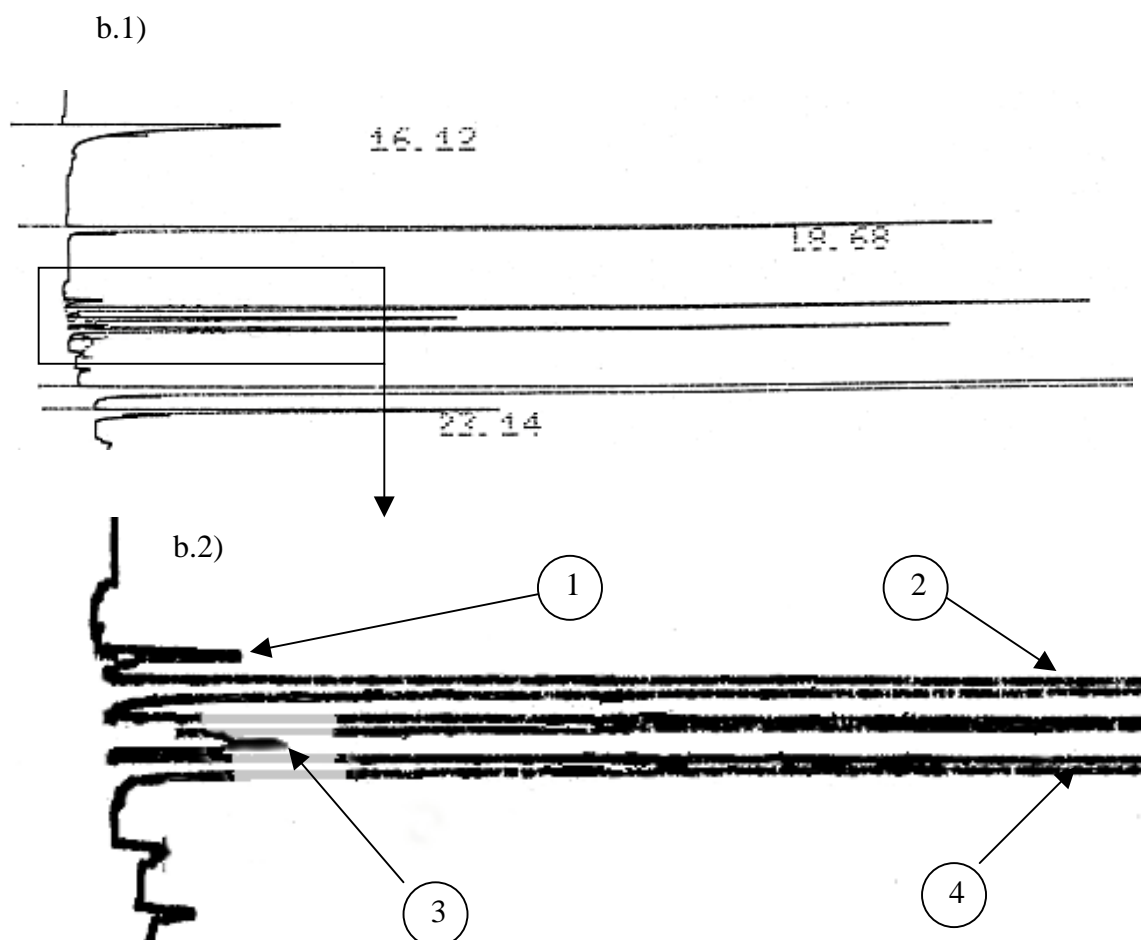

GC-Diagram: Derivatives of (a) racemic mixtures. (b) compound **109**.

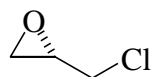
(S)-Epichlorohydrin ((S)-121)**GC:**

Device: HP 5890 Gas Chromatograph, Series II

Column: Chirasil-Nickel, 20 m x 0.25 mm

Conditions: Pressure 50 kPa H₂Temperatureprogram: From 50 °C (3 min) 4 °C/min to 65 °C for (±)-**121**50 °C isotherm for (S)-**121**

Compound	Peak	Retention Time	Area	Area %	ee %
(±)- 121	1	4.892	42678	49.968	-
	2	5.458	42732	50.032	-
(S)- 121	1	2.914	1171119	100.000	> 99
	2	-	-	-	-

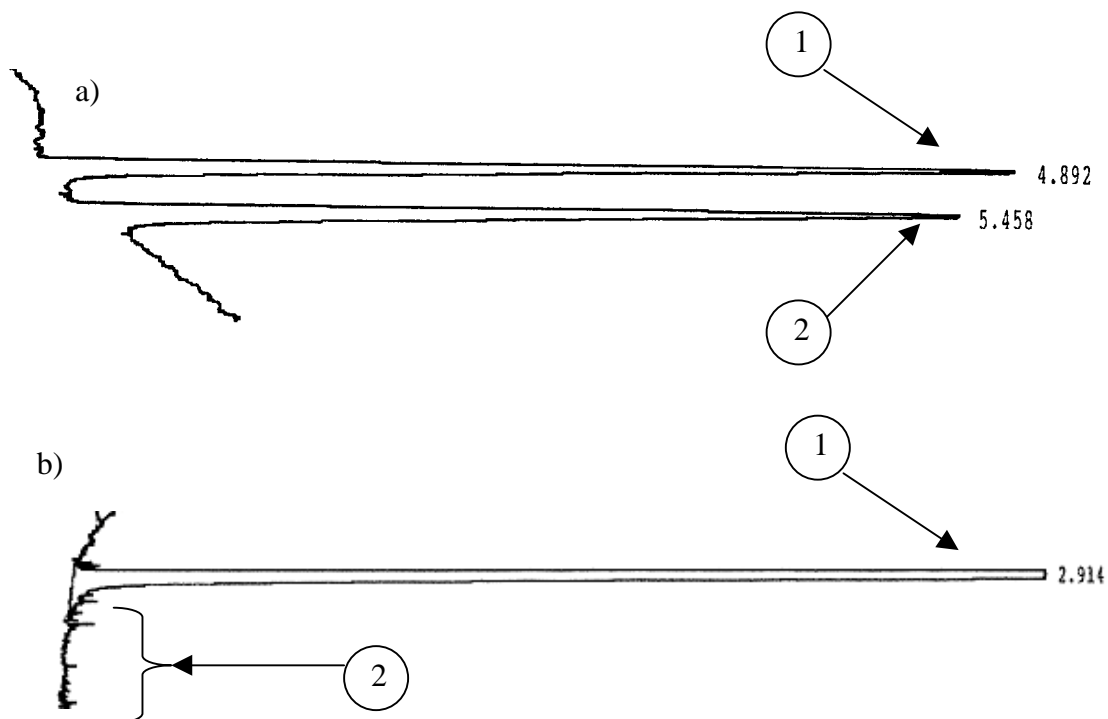
GC-Diagram: (a) racemic mixtures. (b) compound (S)-**121**.

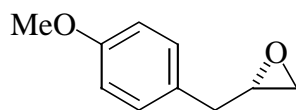
(2S)-2-(4-methoxybenzyl)oxirane ((S)-123)**GC:**

Device: HP 5890 Gas Chromatograph, Series II

Column: Chirasil β -Dex (Fused Silica), 20 m x 0.25 mmConditions: Pressure 35 kPa H₂

Temperatureprogram: From 70 °C (5 min) 3 °C/min to 140 °C

Peak	Retention Time	Area	Area %	ee %
1	28.882	48114	40.255	19
2	29.483	71410	59.745	

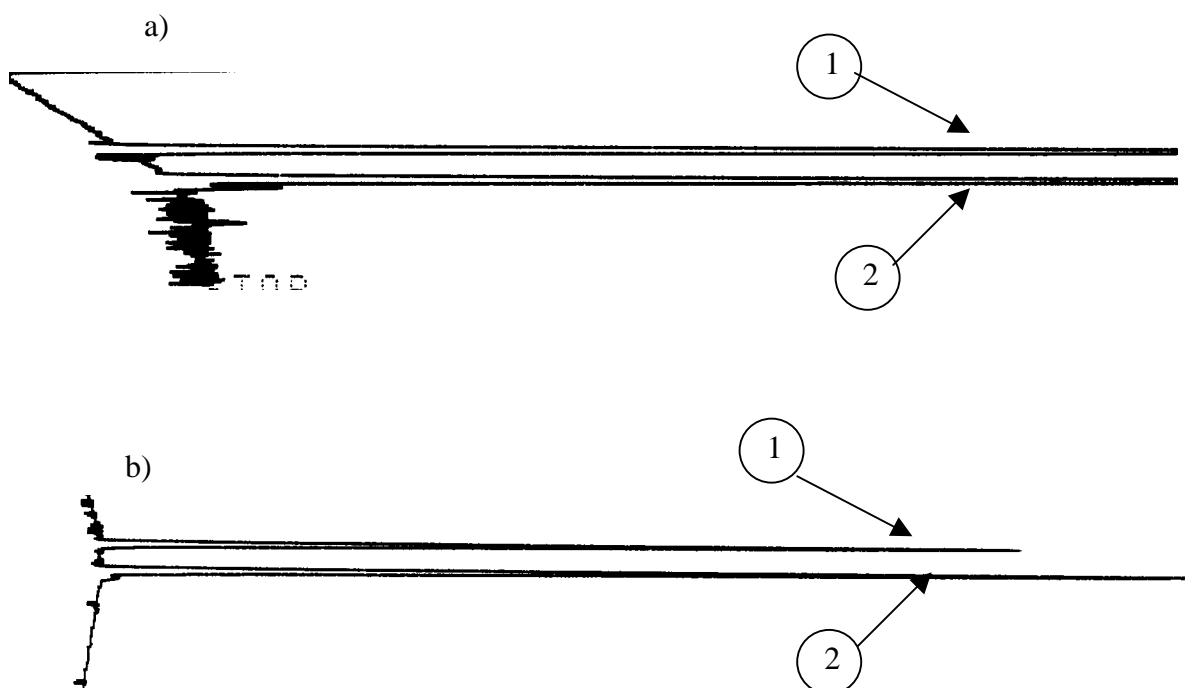
GC-Diagram: (a) racemic mixtures. (b) compound **123**.

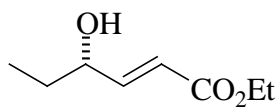
Ethyl (2*E*,4*S*)-4-hydroxyhex-2-enoate (149)**GC:**

Device: HP 5890 Gas Chromatograph, Series II
 Column: Chirasil β -Dex (Fused Silica), 18 m x 0.25 mm
 Conditions: Pressure 35 kPa H₂
 Temperature program: From 60 °C (2 min) 4 °C/min to 160 °C
 Derivative: Iso-propylurethane

Peak	Retention Time	Area	Area %	ee %
1	6.712	136246	1.017	98
2	6.915	13260275	98.983	

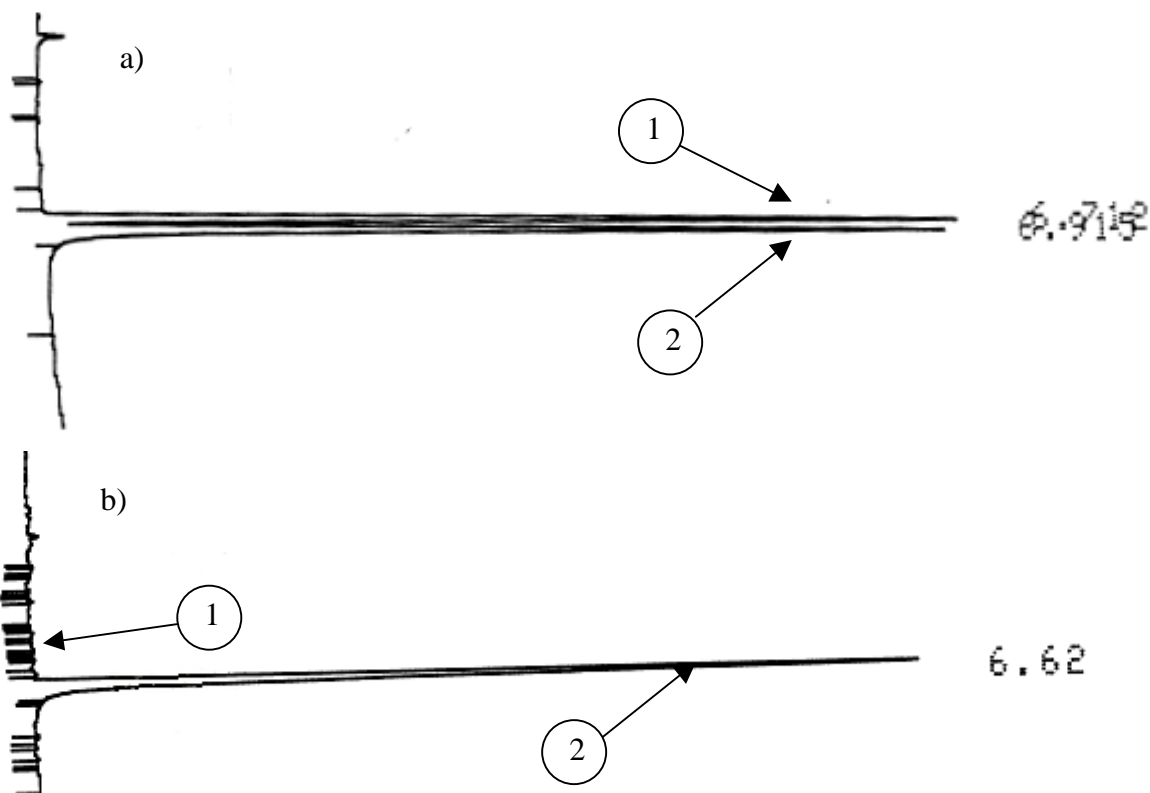

GC-Diagram: Derivatives of (a) racemic mixtures. (b) compound **149**.

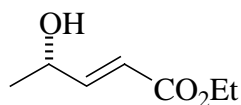
Ethyl (2*E*,4*S*)-4-hydroxypent-2-enoate (154)**GC/MSD 6890 / 5973:**

Device: HP (Agilent) 5871 Gas Chromatograph, Series II

Column: Chirasil Val (Glas Capillary), 20 m x 0.3 mm

Conditions: Pressure 35 kPa H₂

Temperatureprogram: From 60 °C (2 min) 4 °C/min to 160 °C

Derivative: Iso-propylurethane

Peak	Retention Time	Area	Area %	ee %
1	25.934	2096	0.129	99
2	26.062	1624031	99.871	

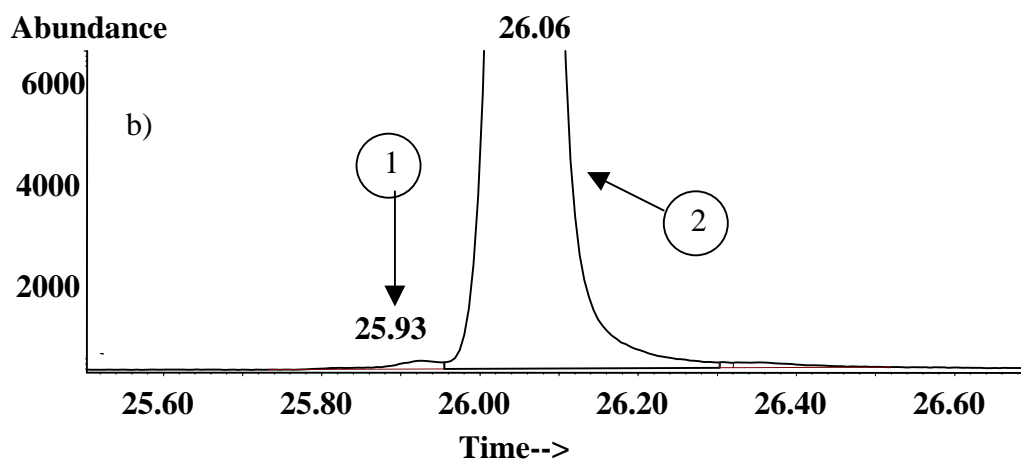
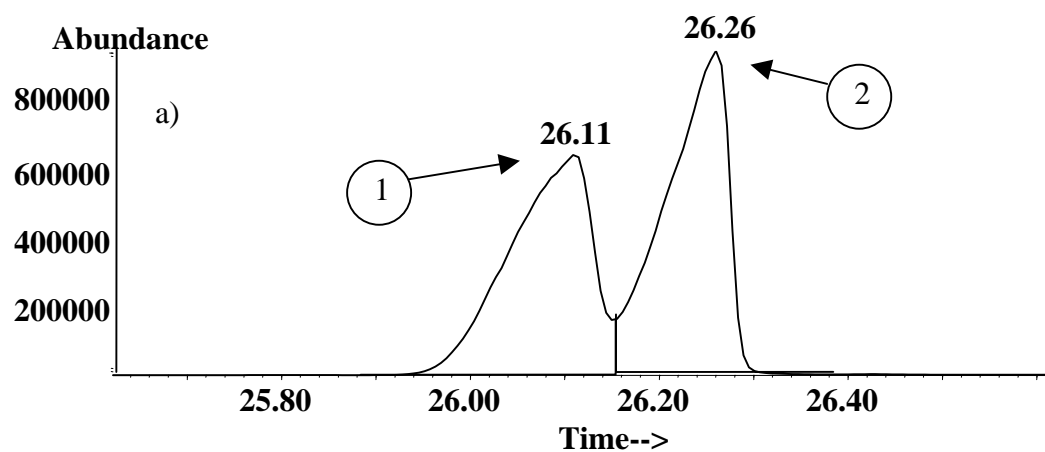
GC/MSD-Diagram: Derivatives of (a) racemic mixtures. (b) compound **15**.

My academic teachers were:

A. Karntiang, A. Petsom, G. Veerachato, M. E. Maier, P. Eamchan, P. Karntiang, S. Kokpol, S. Tip-pyang, T. Vilaivan, T. Ziegler, W. Bhanthumnavin, W. Chavasiri and U. Kokpol.

CURRICULUM VITAE

Name: Saengchai Wattanasereekul

Date of birth: March 27, 1974

Place of birth: Bangkok, Thailand

1989-1992 Wat Bowonniwet School, high school, Bangkok, Thailand.

1992-1996 Senior project with the title 'Structure and *Galleria mellonella*'s Antifeedant Activity Relationship Studies of Eugenol and Related Compounds' under guidance of Assist. Prof. Dr. Warinthorn Chavasiri, Chulalongkorn University, Bangkok, Thailand.

1996-1998 Master thesis with the title 'Structure – Activity Relationship of 4-Hydroxycoumarins and Related Compounds' under guidance of Assist. Prof. Dr. Warinthorn Chavasiri, Chulalongkorn University, Bangkok, Thailand.

1998-1999 Research Assistance, Environmental Research Institute of Chulalongkorn University (ERIC), Bangkok, Thailand.

1999-2001 Scientist (level 4), Faculty of Science, Chulalongkorn University, Bangkok, Thailand.

2001-2005 Doctoral thesis with the title 'A New Synthetic Pathway to 8-Hydroxy Acid as Precursor for the Total Synthesis of Jasplakinolide' under guidance Prof. Dr. Martin E. Maier, Eberhard-Karls-Universität, Tübingen, Germany.