

**Chronological and Cultural Framework of
Bronzes in Northern China during the 4th to the
3rd Millennium B. P.**

**Chronologischer und kultureller Rahmen der
Bronzen in Nordchina während des zweiten bis
ersten vorchristlichen Jahrtausends**

Dissertation
Zur Erlangung des akademischen Grades Doktor der
Philosophie
Der Fakultät für Kulturwissenschaften
der Eberhard-Karls-Universität Tübingen

Vorgelegt von
Junli Jin 金君利
aus Zhejiang
2009

**Gedruckt mit Genehmigung der Fakultät für Kulturwissenschaften
der Eberhard Karls Universität Tübingen**

Gutachter: Prof. Ernst Pernicka, Prof. Dr. Michael Tellenbach

Tag der mündliche Prüfung: 20.01.2009

Dekan: Prof. Dr. Jürgen Leonhardt

Verlag:

Contents

<i>Abstract</i>	<i>vii</i>
<i>Acknowledgements</i>	<i>viii</i>
<i>List of Tables</i>	<i>x</i>
<i>List of Maps</i>	<i>xiii</i>
List of Figures	xiv
Chapter 1 Introduction	1
1.1 The background to the rise of the archaeological research in northern China	1
1.2 Previous studies of the bronzes in northern China	1
1.2.1 From the 1920s to the 1950s	2
1.2.2 From the 1950s to the mid-1970s	4
1.2.3 From the middle 1970s	6
1.3 Scope of this study	9
1.3.1 The temporal scope	9
1.3.2 The spatial scope	12
1.3.3 Three Subregions and complexes	14
1.3.4 ‘Ordos bronzes’ and ‘Northern bronzes’	16
1.4. Aims of this study	17
Chapter 2 Discoveries of bronzes	20
2.1 Discoveries of bronzes in the Qinghai Province	20
2.1.1 Hualong county	21
2.1.2 Gangcha county	22
2.1.3 Ledu county	23
2.1.4 Ping’an county	23
2.1.5 Minhe county: Shanjiatou cemetery	23
2.1.6 Huzhu county	24
2.1.7 Tongren county	25
2.1.8 Xunhua county: Suhusa cemetery	26
2.1.9 Guide and Jianzha county: Shanjiaping cemetery	26
2.1.10 Datong county: Huangjiazhai cemetery	27
2.1.11 Huangyuan county	28
2.1.12 Huangzhong county: Panjialiang cemetery	29
2.1.13 Other sites	30
2.2 Discoveries of bronzes in Ningxia	31
2.2.1 Zhongwei county: Langwozikeng	32

2.2.2 Pengyang county	32
2.2.3 Xiji county	33
2.2.4 Longde county	33
2.2.5 Zhongning county: Niding	34
2.2.6 Guyuan county	34
2.3 Discoveries of Bronzes in the Gansu Province	36
2.3.1 Dongxiang county: Linjia	37
2.3.2 Minle county: Donghuishan	38
2.3.3 Wuwei county: Huangniangniangtai	41
2.3.4 Yongchang county	44
2.3.2 Linxia Hui Autonomous Prefecture and Yongjing county	45
2.3.6 Xihe county: Lanqiao	50
2.3.7 Lintao county: Siwashan	51
2.3.8 Zhuanglang county	51
2.3.9 Qingyang region	52
2.3.10 Gangu county: Maojiaping	53
2.3.11 Qingshui county: Liuping	53
2.3.12 Yumen: Huoshaogou	54
2.3.13 Others	57
2.3.14 The Central Plain bronzes found in the Gansu Province	59
2.4 Discoveries of bronzes in Inner Mongolia	60
2.4.1 Keshenketengqi: Longtoushan	61
2.4.2 Chifeng region	62
2.4.3 Linxi county	63
2.4.4 Ningcheng county	65
2.4.5 Wengniuteqi	67
2.4.6 Aohanqi	68
2.4.7 Liangcheng county	69
2.4.8 Hangjinqi	71
2.4.9 Zhungerqi	72
2.4.10 Yijinhuoluqi: Ming'anmudu and Shihuigou	73
2.4.11 Dongsheng city: Nianfangqu	74
2.4.12 Baotou: Xiyuan	74
2.4.13 Other sites	74
2.4.14 Summary	75
Chapter 3 The Northwest Complex	77
3.1 Qijia culture	78
3.1.1 Distribution	78
3.1.2 Chronology and periodization	78

3.1.3 Copper and bronze	79
3.1.4 Origin	84
3.2 Siba culture	85
3.2.1 Distribution	85
3.2.2 Chronology, periodization and origins	85
3.2.3 Metal objects	86
3.3 Xindian culture	88
3.3.1 Distribution	88
3.3.2 Classification, chronology, periodization, origins and trace	89
3.3.3 Comparing the Xindian culture between the Qinghai and Gansu regions	91
3.3.4 Bronze	92
3.4 Kayue culture	93
3.4.1 Distribution	93
3.4.2 Chronology, periodization and origin	93
3.4.3 Bronzes	95
3.5 Siwa culture	100
3.5.1 Distribution	100
3.5.2 Chronology, periodization and origin	101
3.5.3 Bronzes	101
3.6 Shajing culture	102
3.6.1 Distribution	102
3.6.2 Chronology and periodization	102
3.6.3 Metal objects	103
3.7 Nuomuhong culture	105
3.7.1 Distribution, periodization, chronology, and origin	105
3.7.2 Bronzes	106
3.8 Tangwang-style-pottery and others	106
3.9 Summary	108
3.9.1 Origin and development of the bronze cultures	108
3.9.2 Spatial distribution and interactions	110
Chapter 4 The North-central Complex	112
4.1 Zhukaigou culture	112
4.1.1 Definition and distribution	112
4.1.2 Periodization and chronology	113
4.1.3 Cultural elements	115
4.1.4 Metal objects	115
4.2 Lijiaya culture	126
4.2.1 Definition and distribution	126

4.2.2	Periodization and chronology	129
4.2.3	Metal objects	130
4.3	Xicha culture	132
4.3.1	Definition and relations between the Zhukaigou culture, Lijiaya culture and Xicha culture	132
4.3.2	Metal objects	133
4.4	Maoqinggou culture	133
4.4.1	Definition and distribution	133
4.4.2	Chronology, periodization, and characteristics	135
4.4.3	Metal objects	137
4.5	Taohongbala culture	137
4.5.1	Definition and distribution	137
4.5.2	Chronology and periodization	140
4.5.3	Metal objects	141
4.6	Yanglang culture	149
4.6.1	Definition and distribution	149
4.6.2	Chronology, periodization, and relations with the neighboring cultures and others	152
4.6.3	Metal objects	153
4.7	Summary	155
Chapter 5 The South of the Yanshan Complex.....		157
5.1	Datuotou culture	157
5.1.1	Definition and distribution	157
5.1.2	Chronology, periodization, and origin	159
5.2.3	Metal objects	161
5.2	Weifang III culture	161
5.2.1	Definition and distribution	161
5.2.2	Chronology, cultural elements, and origin	164
5.2.3	Metal objects	165
5.3	Upper Zhangjiayuan culture	165
5.3.1	Definition and distribution	165
5.3.2	Chronology, origin, and cultural attribution of some sites	167
5.3.3	Metal Objects	168
5.4	Yuhuangmiao culture	169
5.4.1	Definition and distribution	169
5.4.2	Chronology and some problems	172
5.4.3	Metal objects	172
5.5	Summary	175

Chapter 6 Chronological and cultural framework of bronzes in northern China 177

6.1 Northwest Complex 177

6.1.1 From the late Neolithic to the early Shang period (2300-1500 BCE): the continuity of agricultural economics and the rise of the earliest copper/bronze metallurgy 177

6.1.2 From the early Shang to the early Western Zhou Period (1500-1050 BCE): the rise of animal husbandry and the initial development of the bronze metallurgy 179

6.1.3 From the early Western Zhou period to the middle Spring and Autumn period (1050-400 BCE): the prevalence of a mixture of farming and animal husbandry, and the disparate development of bronze metallurgy 180

6.1.4 Summary 181

6.2 North-central Complex and south of the Yanshan Complex 183

6.2.1 From the early Xia period to the late Shang period (1900-1250 BCE): the continuity of the agricultural economics and the rise of copper/bronze metallurgy 183

6.2.2 From the late Shang period to the middle Western Zhou period (1250-900 BCE): the prevalence of a mixture of economics: farming, animal husbandry, and hunting, and the development of the northern-style bronzes 186

6.2.3 From the early Spring and Autumn period to the end of the Warring States (800-200 BCE): The prosperity of animal husbandry and flourishing of the northern-style metal objects 186

6.2.4 Summary 188

6.3 Interactive relations between complexes 189

Chapter 7 Relations with the neighboring cultures 190

7.1 Relations with the Central Plain 190

7.1.1 The rise of the dynasties in the Central Plain 190

7.1.2 Relations between North-central China and the Central Plain 191

7.1.3 Relations between the South of the Yanshan and the Central Plain 194

7.1.4 Political interaction 194

7.2 Relations with the Xinjing region 196

7.2.1 The Bronze Age and Iron Age cultures in Xinjiang 196

7.2.2 Relations between Xinjiang and northern China 199

7.3 Relations with the Eurasian Steppe 201

7.3.1 Early period: 3000-1800 BCE 202

7.3.2 Middle period: 1800-800 BCE 203

7.3.3 Late Period: 800-200 BCE 206

7.4 Origin of the Chinese bronzes	206
7.4.1 The earliest copper/bronze objects in China	208
7.4.2 The copper-arsenic alloy in northern China and lead-containing ore resources	214
Chapter 8 Conclusions.....	216
Maps	222
Figures	257
Appendix: List of Radiocarbon dates	475
Bibliography	483

Abstract

This thesis first collects and presents all the basic, objective, and complete information currently available on bronze objects, site by site in northern China during the 4th and 3rd millennium B. P. with particular attention being paid to the catalogue, figures, and related cultural ascription of the bronze objects.

It surveys archaeological complexes located in the northeast, north-central, and northwest of China. Their distribution, chronology, periodization, cultural features, origins, and the bronze assemblages and metallurgical techniques unique to each culture are the main focus. The cultural development of each complex, and the cultural connections between various archaeological complexes during different periods are also discussed. Apart from the internal connections within the northern bronze cultures, their external relations, namely their relations with the Central Plain, Xinjiang region and the Eurasian Steppe are also analyzed. The cultural and chronological framework of bronzes in northern China during the 4th and 3rd millennium B. P. is thus provided.

Finally, this study offers an insight into the origins of early metallurgy in northern China, on the basis of an analysis on all of the earliest copper/bronze objects available in northern China, providing an opportunity for a fresh understanding on the origin of the earliest metallurgy in the world.

Acknowledgement

I am indebted to Professor Korfmann, my first academic advisor at the University of Tübingen, whose expertise, enthusiasm and insight into archaeology encouraged me to persist with this work. His passing away is a great loss to us all.

I would like to express my extreme gratitude to Professor Pernicka, my principal advisor, for his guidance, support and continuous constructive advice throughout this study. Due to being influenced by Professor Pernicka, I chose to study the earliest metallurgy in China, which has opened a new perspective in my mind, and has broadened my views. Without his support and encouragement, I would never have been able to complete my dissertation. I am also very grateful to Dr. Wagner, who has helped me greatly, providing effective suggestions for the structure and style of this dissertation as well as stimulating me to make greater efforts. I would like to thank Professor Tellenbach very much for being my second supervisor, who gives me a great help in a hard situation.

This work was made possible by substantial financial support from the Sun Hung Kai Properties Foundation in Hongkong, to whom I would like to express my sincere and profound gratitude for their generous provision for a four-year scholarship, which enabled me to complete this work.

I would also like to take this opportunity to express my gratitude to my teachers at the Jilin University in China, where I spent my undergraduate and postgraduate years before coming to the Tübingen University in Germany. Professor Yang Jianhua has given me both her opinions and suggestions about this topic based on her solid knowledge in this area. Professor Lü Jun has also inspired me greatly.

Throughout this study, many people have provided me with their advice, support, encouragement and assistance. I wish especially to thank Utta Gabriel at the Tübingen University for her continuous help and encouragement. I am also thankful to Christel Bock for her kindness and helping me to lead a comfortable life during my time studying at the Tübingen University, Germany.

When I was collecting data for my dissertation in China, many scholars and friends also helped me. I owe a particular debt to them all at the Jilin University: Jiang Lu, Tang Miao, Jiang Gang, Shao Huiqiu, Han Jinqiu and so on.

I would also like to express my special gratitude to Edel Flynn, Barbara Black and

Kinkiong Lee for their kind help in polishing my English as well as Feng Wuyong for his help in Japanese. Furthermore, I am very grateful to Florian Zug, who provided me with much encouragement as well as technical supports for making some maps.

Last but by no means least, I owe an enormous debt of gratitude to my parents, who have always allowed me to pursue whatever I want, and have always been supportive and encouraging. I would like to thank my brother and sister-in-law very much, for not only supporting me throughout my study but also for taking care of my parents. I dedicate this dissertation to my parents for their love and commitment.

List of Tables

Table 1. Foreign expeditions to northern China between 1898 and 1924.....	2
Table 2. Different periodization of the Shang Dynasty	11
Table 3. The chronological framework of the Xia, Shang and Zhou dynasties.....	12
Table 4. Basic information on the 15 bronzes found at Donghuishan, Minle county, Gansu Province.	39
Table 5. Results of the Atomic Absorbing Spectrum Analysis on the Bronzes of the Siba culture found at Donghuishan in Minle, Gansu	39
Table 6. Metallographic structure of the bronzes from the Dongshuishan, Minle county, Gansu Province	41
Table 7. Results on the identification of the bronzes from Huangniangniangtai.....	43
Table 8. Compositional analysis on the samples from Wajiazhui and Heitouzu	46
Table 9. Compositional analysis on the samples from Zhangjiazui.....	47
Table 10. Results from the analysis of copper and bronze objects found in Huoshaogou, Qingquan, Yumen county, Gansu Province	55
Table 11. Results from the quantitative composition analysis of copper and bronze objects found at Huoshaogou, Qingquan, Yumen, Gansu Province	57
Table 12. Materials and artifacts of the Siba culture found at Ganguya in Fengle, Gansu	58
Table 13. Manufacturing techniques and types of Siba artifacts found at Ganguya in Fengle, Gansu	58
Table 14. Manufacturing techniques and types of Siba artifacts found at Ganguya in Fengle, Gansu	59
Table 15. Test results from copper and bronze artifacts found in the Qijia culture of Gansu	81
Table 16. Types, amount, archaeological contexts of the copper and bronze objects of the Qijia culture.....	82
Table 17. Comparison of three groups of copper and bronze objects from the Qijia culture.	83
Table 18. Chronology of the bronzes of the Qijia culture.....	84
Table 19. Metal objects of the Siba culture.....	87
Table 20. Bronze objects of the Xindian culture.....	92
Table 21. Periodization of the bronzes of the Kayue culture in the Huangshui valley	96
Table 22. Periodization of the bronzes of the Kayue culture in the Yellow River valley	96
Table 23. Copper and bronze objects of the Siwa culture.....	102
Table 24. Composition analysis of some bronzes in the Shajing culture	104
Table 25. Copper and bronze objects of the Nuomuhong culture.....	106
Table 26. Bronzes of the Zhukaigou site.....	117

Table 27. Bronzes of the Zhukaigou culture that have been analyzed.....	118
Table 28. Composition of the bronze artifacts from the third and fourth stage of the Zhukaigou site.....	118
Table 29. Composition of the bronzes from the fifth stage of the Zhukaigou site.....	119
Table 30. Comparing the bronzes between the third and fourth stage and the fifth stage of the Zhukaigou site.	121
Table 31. Mechanical properties of the bronzes discovered from the Zhukaigou site	121
Table 32. Results for the metallurgical structure of the bronzes from the third and fourth stage of the Zhukaigou site	123
Table 33. Results for the metallurgical structure of the bronzes from the fifth stage of the Zhukaigou site.....	125
Table 34. Discoveries of the bronzes of the Lijiaya culture.....	128
Table 35. Periodization of the Lijiaya culture proposed by Zou H.	130
Table 36. Periodization of the Lijiaya culture proposed by Zhang Changshou, Zheng Zhenxiang, and Chen Zhida.....	130
Table 37. Discoveries of the bronze objects of the Maoqinggou culture.....	135
Table 38. Discoveries of the metal objects from the Taohongbala culture.....	140
Table 39. Chemical component of the Ordos bronzes	144
Table 40. Results of the metallurgical analysis of the Ordos bronzes.....	146
Table 41. Results of the metallurgical analysis of the Ordos bronzes	148
Table 42. Discoveries of the metal objects from the Yanglang culture.....	151
Table 43. Bronzes of the Datuotou culture.....	158
Table 44. Stratigraphical evidence of the Datuotou culture.....	159
Table 45. Periodization of the Datuotou culture.....	160
Table 46. Bronze objects from the Weifang III culture.....	162
Table 47. Opinions regarding the Weifang III culture as an independent culture.....	163
Table 48. Opinions against the Weifang III culture as an independent culture.....	163
Table 49. Periodization of the Weifang III culture proposed by Wu En and Yang Jianhua.....	164
Table 50. Bronzes from the Upper Zhangjiayuan culture.....	166
Table 51. Discoveries of bronze objects from the Yuhuangmiao culture suggested by Wu En.....	171
Table 52. Composition of the bronze objects from Jundushan.....	175
Table 53. Population size during different periods at the Liuwan cemetery	183
Table 54. Amount of different animals found at the Zhukaigou site	184
Table 55. Animal percentage during different stages at the Zhukaigou site.....	184
Table 56. The cultural framework in Xinjiang proposed by Mei Jianjun.....	197
Table 57. The chronological sequence for the Bronze Age and Iron Age cultures in Xinjiang.....	198

Table 58. The earliest copper and bronze objects found in China.213

List of Maps

Map 1. The physical geography of northern China,	222
Map 2. Sub-regions of northern China in this study.	223
Map 3. Distribution of annual mean temperate (°C) in China.	224
Map 4. Distribution of annual precipitation (mm) in China	225
Map 5. Distribution of aridity indices in China.	226
Map 6. Distribution of major grassland types in China	226
Map 7 Distribution of the Qijia culture.....	227
Map 8. The Qijia culture sites that were discovered with bronze objects	228
Map 9. Distribution of the Xindian culture.....	229
Map 10. Distribution of the Kayue culture	230
Map 11. Distribution of the Siwa culture.....	231
Map 12. Distribution of the Siba culture.	232
Map 13. Distribution of the Shajing culture.	233
Map 14. Geography of northwest China.....	234
Map 15. Distribution of the Zhukaigou culture and the Xicha culture.....	235
Map 16. Distribution of the Lijiaya culture	236
Map 17. Distribution of the Maoqinggou culture.	237
Map 18. Distribution of the Taohongbala culture	238
Map 19. Distribution of the Yanglang culture.....	239
Map 20. Distribution of the Datuotou culture.....	240
Map 21. Distribution of the Weifang III culture	241
Map 22. Distribution of the Upper Zhangjiayuan culture.....	242
Map 1. Distribution of the Yuhuangmiao culture.....	243
Map 24. Bronze-using cultures in northern China during the 4th and 3rd millennium B. P.	244
Map 25. Territory of the Shang Dynasty.....	245
Map 26. Territory of the Western Zhou Dynasty	246
Map 27. Territory of the Eastern Zhou Dynasty	247
Map 28.	248
Map 29. Distribution of the Shang, Pre-Zhou and Zhou cultures.....	249
Map 30. Location of the Great Wall during the Warring States and northern culture sites.	250
Map 31. Cultural influence on prehistoric Xinjiang from the neighboring regions. .	251
Map 32. The locations of the Afanasievo, Andronovo and Machang cultures in Eurasia.....	252
Map 33. Distribution of the Andronovo-related sites found in Xinjiang.....	253
Map 34. Early sites yielding metal-by period and type	254
Map 35. Various metal resources in China.	255

Map 36. Silver and gold resources in China.	256
--	-----

List of Figures

Fig. 001. Shangbanzhuwa, bronze funeral objects	257
Fig. 002. Xiabanzhuwa, bronze funeral objects.....	257
Fig. 003. Gangcha, bronze funeral objects	257
Fig. 004. Hongshui, bronze arrowhead.....	258
Fig. 005. Shaka, bronze funeral objects.....	258
Fig. 006. Shanjiatou, Tomb M4, robe hook, L 7.8cm	258
Fig. 007a. Zongzhai, funeral objects.....	258
Fig. 007b. Zongzhai, tombs M38 and M39, burial goods.....	259
Fig. 008. Zong'an temple, stray finds of bronze artifacts.....	259
Fig. 009. Suhusa, bronze funeral objects	260
Fig. 010. Chengxi, collected bronze artifacts	260
Fig. 011. Shanpingtai, bronze funeral objects.....	260
Fig. 012. Liangjiao, collected bronze artifacts.....	261
Fig. 013. Huangjiazhai, bronze funeral objects	261
Fig. 014a. Dahuazhongzhuang, bronze funeral objects	262
Fig. 014b. Dahuazhongzhuang, graves	263
Fig. 014c. Dahuazhongzhuang, graves	264
Fig. 015a. Mobula, plan of house F1 and F2.	265
Fig. 015b. Mobula, House F3 and F4.	265
Fig. 015c. Mobula, house F1.	266
Fig. 016a. Huabiliang and Luanshan, bronze funeral objects.....	267
Fig. 016b. Huanyuan county, collected bronze objects.....	267
Fig. 017a. Panjialiang, distribution of the tombs.....	267
Fig. 017b. Panjialiang. bronze funeral objects.....	268
Fig. 017c. Panjiangliang, Tomb 117.	269
Fig. 017d. Panjialiang, Tomb M210	270
Fig. 017e Panjialiang, tomb M221.....	270
Fig. 017f. Panjialiang, 1 Tomb M144; 2 Tomb M52	271
Fig. 017g. Panjialiang, Tomb M150	272
Fig. 017h. Panjialiang, left, tomb M46; right tomb M47.....	272
Fig. 017i. Panjialiang, upper, tomb M43; right, tomb M50.....	273
Fig. 017j. Panjialiang, Tomb M202 and Tomb M201	274
Fig. 018. Collected bronzes, 1-3 found from Huangzhong county; 4 found from Xining	275
Fig. 019. Bronze objects, 1-3 from Gamatai; 4-9 from Zongri.....	275
Fig. 020a. Fengtai, trench TG1, West Profile.	276

Fig. 020b. Fengtai, trench TG1, East Profile	277
Fig. 020c. Fengtai, trench TG2, South Profile.....	278
Fig. 021. Langwozikeng, bronze funeral objects	279
Fig. 022a. Zhangjie, collected bronzes	280
Fig. 022b. Zhangjie, tombs and funeral objects.....	281
Fig. 023. Miyuan, bronze objects.....	282
Fig. 024. Xianma, bronze objects	282
Fig. 025. Guantai, bronze objects	283
Fig. 027. Baicha, bronze objects	284
Fig. 028. Dianwa, bronze objects.....	284
Fig. 029. Pengyang county, bronze objects.....	285
Fig. 030. Chenyangchuan, metal objects.	285
Fig. 031. Bronze objects, 1-2 from Danbei, 3-5 from Baizigou, 6 from Yuqiao, 7 from Maogou.	286
Fig. 032. Bronze objects, 1-8 from Wugou; 9-11 from Heshenlin; 12-17 from Shatang.	286
Fig. 033. Niding, bronze funeral objects.....	287
Fig. 034. Xijiao, collected metal objects.....	287
Fig. 035. Yangwa, bronze objects	288
Fig. 036. Dabeishan, bronze objects	288
Fig. 037. Wangjiaping, bronze objects.....	288
Fig. 038. Lüping, bronze objects	289
Fig. 039. Guyuan, collected bronze and gold objects.....	289
Fig. 040. Ningxia, metal objects	290
Fig. 041a. Guzhuang, 1 Tomb IIM1; 2 Tomb IIM3; Tomb IM4; Tomb IIM4	291
Fig. 041b. Mazhuang, bronze funeral objects.....	292
Fig. 041c. Mazhuang, bronze funeral objects	293
Fig. 041d. Mazhuang, bronze funeral objects.....	294
Fig. 041e. Mazhuang, metal objects	295
Fig. 042. Sunjiazhuang, funeral objects.....	295
Fig. 043a. Linjia, plan of excavation district	296
Fig. 043b. Linjia. 1 bronze knife found from F20:18, L 12.5cm; 2 metallurgical structure of the bronze knife	297
Fig. 044a. Donghuishan, bronze objects	298
Fig. 044c. Donghuishan, metallographic structure of the bronzes	299
Fig. 045a. Huangniangniangtai, bronze objects.....	300
Fig. 045b. Huangniangniangtai, plan of the fourth excavation.....	300
Fig. 045c. Huangniangniangtai, joint tombs,.....	301
Fig. 045d. Huangniangniangtai, plan of House F8.	302
Fig. 046a. Bronze objects, 1.2 from Sanjiaocheng; 3-8 from Hamadun.	302

Fig. 046b. Bronze objects, 1-7 from Sanjiaocheng; 8-41 from Hamadun.....	303
Fig. 046c. Hamadun, distribution of the tombs	303
Fig. 046d. Hamadun, Tombs M19 and M18.....	304
Fig. 047a. Lianhuatai, bronzes objects.....	304
Fig. 047b. Lianhuatai, 1 plan of tomb M10 and M11; 2-4 potteries from Tomb M10; 5-6 potteries from Tomb M11	305
Fig. 048. Zhangjiazui, bronze objects.....	305
Fig. 049a. Copper and bronze objects, 1 from Dahezhuang; 2-7 from Qinweijia.....	305
Fig. 049b. Dahezhuang, 1 plan of House F7; 2 recovery of House F7; 3 Plan of F1; 4 pit H10 and H7.....	306
Fig. 050a. Dahezhuang, the southern part of the cemetery.....	307
Fig. 050b. Qinweijia, the northern part of the cemetery	308
Fig. 051a. Lanqiao, tombs, 1 Tomb M4; 2 Tomb M6	309
Fig. 051b. Lanqiao, bronzes.....	309
Fig. 052. Siwashan, bronze bracelet.	309
Fig. 053. Shaoping, bronzes objects	310
Fig. 054. Xujianian, bronze objects.	310
Fig. 055a. Jiuzhan, bronzes objects.	311
Fig. 055b. Jiuzhai, tombs: A M3; B M17; C M28 and M78; D M36 and M63	312
Fig. 055c. Jiuzhan, tombs: A M11; B M19; C M32 and M33; D M40 and M71; E M47; F M1.....	313
Fig. 055d. Jiuzhan, tombs	314
Fig. 056. Bronze objects in the Western Zhou style, A from Yu; B from Jiao.....	315
Fig. 057. Yuanjia, bronze object.....	316
Fig. 058. Houzhuang, bronze objects.....	316
Fig. 059. Miaoqu, bronze objects.....	317
Fig. 060. Hongyan, bronzes objects.....	317
Fig. 061. Wujiagouquan, bronze objects.....	318
Fig. 062. Bronze objects, 1-13.20 from Qingyang region; 14.15 from Mazhai; 16.17 from Ligou; 18.19 from Tatou	318
Fig. 063a. Maojiaping, section plan of the east wall of Square T1 and T2, 1 soil; 2 disturbed soil; 3 gray soil; 4A yellowish gray soil; 4B dark gray soil; 5A gray brown soil; 5B yellow soil; 6 red soil	319
Fig. 063b. Maojiaping, potteries	320
Fig. 063c. Maojiaping, bronzes objects	321
Fig. 064a. Liuping, bronze objects.....	322
Fig. 064b. Liuping, gold objects	323
Fig. 065a. Xigang, tombs	324
Fig. 065b. Xigang, tombs.....	326
Fig. 065d. Xigang, tombs.....	326

Fig. 065e. Xigang, tombs	327
Fig. 065f. Xigang, metal objects	328
Fig. 065g. Xigang, metal objects	329
Fig. 065h, Xigang, metal objects.	330
Fig. 066. Yushugou, bronze objects	331
Fig. 067. Qin'an, bronze objects	331
Fig. 068. Bronze objects.	331
Fig. 069. Bronze objects in the the Central Plains style found in the Gansu Province.	332
Fig. 070. Bronze objects in the Central Plains style	332
Fig. 071a. Baicaopo, burial goods of Tomb M2	333
Fig. 071b. Baicaopo, tombs and burial goods, A Tomb M1; 2 Tomb M7; C chariot pit	334
Fig. 072. Longtoushan, bronzes objects.....	335
Fig. 073. Xiajiadian, bronze objects,	335
Fig. 074a. Zhizhushan, bronze objects.....	336
Fig. 074b. Zhizhushan, potteries of the four succeeding layers.....	336
Fig. 075. Metal objects, 1-3 from Susitai; 4 from Dayingzi	337
Fig. 076a. Jinggouzi, tomb excavated in 1996.....	337
Fig. 076b. Jinggouzi, bronzes objects.....	338
Fig. 077a. Nanshangen, collected bronzes in 1958.....	338
Fig. 077b. Nanshanben, Tomb M3 and M4, A Tomb M4; B Tomb M3.....	339
Fig. 077c. Nanshan'gen, Tomb M 101.....	340
Fig. 077d. Nanshangen, Tomb M102.....	341
Fig. 077e. Nanshangen, distribution of tombs.	344
Fig. 078b. Xiaoheishigou, funeral objects.	344
Fig. 079. Metal objects, A from Beishanzui, Tomb M7501; B from Xiaoheishigou, Tomb M8061	345
Fig. 080. Dapaozi, funeral objects	346
Fig. 082. Tiejiangou, burials goods.....	347
Fig. 083a. Zhoujiadi, funeral objects	349
Fig. 084a. Yinniugou, tombs: 1 97YM1; 2 97YM2; 3 97YM3; 4 97YM6; 5 97YM5; 6 97YM4; 7 97YM7; 8 97YM8; 9 97YM9	350
Fig. 084b. Yinniugou, tombs: 1 97YM10; 2 97YM11; 3 97YM12; 4 97YM13; 5 97YM14; 6 97YM16; 7 97YM17	351
Fig. 084c. Yinniugou, tombs: 1 97Y18; 2 97Y19; 3 97YM20; 4 97YM21; 5 97YM 22; 6 97YM 23	352
Fig. 084d. Yinniugou, funeral objects.....	354
Fig. 085a. Maoqinggou, tombs and funeral goods.....	355
Fig. 085b. Maoqinggou, tombs and funeral goods,	357

Fig. 085c. Maoqinggou, tombs and funeral goods.....	358
Fig. 085d. Maoqinggou, plan of cultural remains.....	360
Fig. 085e. Maoqinggou, distribution of the tombs.....	361
Fig. 086a. Guoxianyaozi, tombs and funeral goods.....	363
Fig. 086c. Guoxianyaozi cemetery, plan of tombs.....	364
Fig. 087. Taohongbala, tombs and funeral goods	365
Fig. 088. Aluchaideng, metal objects.....	366
Fig. 089. Xigoupan, tombs and funeral objects	367
Fig. 090. Baihaishe, bronze objects	367
Fig. 091. Yulongtai, funeral objects.	368
Fig. 092. Sujigou, bronze objects.....	369
Fig. 093. Funeral objects, 1-19 from Minganmudu; 20-31 from Shihuigou; 32-34 from Fanjiayaozi	370
Fig. 094. Nianfangqu, gold and silver objects from hoard,	370
Fig. 095. Xiyuan, tombs and funeral objects	371
Fig. 096. Hulusitai, funeral objects	371
Fig. 097. Metal objects, 1 from Salaqi; 2-8 from Shuijiangoumen; 9-12 from Goulitou; 13 from Nanpaoziya; 14-34 from Chenbaerhuqi	372
Fig. 098a. Chaiwangang, tombs and funeral objects	373
Fig. 098b. Chaiwangang, tombs and funeral objects	374
Fig. 098c. Chaiwangang, tombs and funeral objects.	375
Fig. 098d. Chaiwangang, metal objects	376
Fig. 098e. Chaiwangang, metal ornaments.....	377
Fig. 098f. Chaiwangang, metal objects.....	378
Fig. 099a. Qijia culture, relative periodization of sites: Liuwan, Huangniangniangtai, Qinweijia and Dahezhuang	379
Fig. 099b. Qijia culture, copper and bronze objects.	380
Fig. 099c. Qijia culture and Upper Changshan culture, potteries	381
Fig. 100a. Xindian culture, periodization of the sites: Shanjiatou, Lianhuatai, Yanchang, Xindian.....	382
Fig. 100b. Xindian culture, periodization of the sites: Jijiachuan, Zhangjiazui, Hetaozhuang, Tangwangchuan, Shangsunjiazhai, Liuwan	383
Fig. 100c. Xindian culture, Xiaohandi potteries	384
Fig. 100d. Xindian culture, potteries	385
Fig. 100e. Xindian culture, bronze objects	386
Fig. 101a. Kayue culture, periodization of the Huangshui valley sites: Panjialiang, Xinxihe, Huangjiazhai and Dahuazhongzhuang.....	387
Fig. 101b. Kayue culture, periodization of the Yellow River region sites: Ahatela, Shangbanzhuwa and Shanpingtai	388
Fig. 101c. Comparing the early Kayue culture with the late Qijia culture	389

Fig. 101d. Kayue culture, copper and bronze objects.....	395
Fig. 102. Bronze spears with tubular handle found in China and south Siberia.....	396
Fig. 103a. Siwa culture, periodization of the sites: Siwashan, Xujianian and Jiuzhan	397
Fig. 103b. Siwa culture, copper and bronze artifacts.....	398
Fig. 104a. Siba culture, periodization of the sites: Donghuishan and Huoshaogou ..	399
Fig. 104b. Siba culture, copper and bronze objects.	400
Fig. 105a. Shajing culture, periodization of the sites: Shajing, Hamadun and Sanjiaocheng	401
Fig. 105b. Shajing culture, periodization of the sites: Xigang and Chaiwangang....	402
Fig. 105c. Shajing culture, metal objects	403
Fig. 105d. Shajing culture, metal objects, Xigang	404
Fig. 105e. Shajing culture, metal objects, Chaiwangang	405
Fig. 106a. Nuomuhong culture, periodization of the Dalitaliha site.....	407
Fig. 106b. Comparing the Nuomuhong culture, Qijia culture and Kayue culture.....	408
Fig. 106c. Nuomuhong culture, copper and bronze artifacts	408
Fig. 107a. Tangwang-style-pottery, periodization of the sites at Suhusa, Ahatela, Gongbeitai, Shangsunjiazhai, and Zhangkashan	409
Fig. 108a. Zhukaigou culture, periodization of the potteries	410
Fig. 108b. Zhukaigou site, potteries.....	411
Fig. 108c. Zhukaigou culture, metal objects.....	412
Fig. 108d. Zhukaigou site, back reflected electron image of the bronze artifacts	413
Fig. 108e. Zhukaigou site, metallurgical structure of the bronze artifacts	414
Fig. 108f. Zhukaigou site, metallurgical structure of the bronze artifacts.	415
Fig. 108g. Zhukaigou site, metallurgical structure of the bronzes.....	416
Fig. 108h. Zhukaigou site, metallurgical structure of the bronzes.....	417
Fig. 108i. Trans-Baikal area, snake-motif potteries	418
Fig. 109a. Lijiaya culture, potteries	418
Fig. 109b. Lijiaya culture, metal objects.....	420
Fig. 111a. Datuotou culture, periodization of the sites	420
Fig. 111b. Xueshan II, potteries.	421
Fig. 111c. Datuotou culture, metal objects.....	422
Fig. 112b. Weifang III culture, metal objects.....	423
Fig. 112c. Northern bronzes found in central China during the Yinxu period.....	424
Fig. 113a. Baifu cemetery: A tomb M2, B tomb M3	425
Fig. 113b. Baifu cemetery, bronze objects	426
Fig. 113c. Baifu cemetery, bronze objects	427
Fig. 114. Xiaohenan, bronze objects.....	428
Fig. 115. Xibozi, bronze objects.	428
Fig. 116. Dongnangou cemetery, tombs and funeral goods.....	429

Fig. 117a. Upper Zhangjiayuan culture, potteries.....	429
Fig. 117b. Upper Zhangjiayuan culture, bronze objects and molds.....	430
Fig. 118. Beixinbao, metal objects.....	431
Fig. 119. Qingzigou, bronze objects	431
Fig. 120. Luotuoliang, bronze objects	432
Fig. 121. Paotaishan, bronze objects.....	433
Fig. 122a. Ganzibao, bronze ritual objects	434
Fig. 122b. Ganzibao, bronze objects.....	435
Fig. 122c. Ganzibao, metal objects	436
Fig. 123. Baimiao, bronze objects.	437
Fig. 124. Nihezi, bronze objects	437
Fig. 125. Xiaobaiyang, bronze objects	438
Fig. 126a. Lishugoumen, bronze objects	439
Fig. 126b. Lishugoumen, bronze objects	440
Fig. 126c. Lishugoumen, bronze objects	441
Fig. 127. Daolazui, metal objects.....	442
Fig. 128a. Longqingxia, metal objects.....	442
Fig. 128b. Longqingxia, bronze objects.....	443
Fig. 129a. Yuhuangmiao cemetery, bronze objects.....	444
Fig. 129b. Yuhuangmiao cemetery, bronze objects.....	445
Fig. 130a. Yuhuangmiao culture, potteries	445
Fig. 130b. Yuhuangmiao culture, bronze objects in the Central Plains style.....	446
Fig. 130c. Yuhuangmiao culture, metal objects.	447
Fig. 131a. Maoqinggou culture, potteries,	448
Fig. 131b. Maoqinggou culture, metal objects.	449
Fig. 131c. Maoqinggou culture, metal objects.....	450
Fig. 132. Metal objects, 1-15 Nalingaotu; 16-22 Lijiapan; 23 Laolongchi; 24 Majiagaigou	451
Fig. 134a. Taohongbala culture, metal objects.....	452
Fig. 134b. Taohongbala culture, gold belt ornaments, 1 Xigoupan; 2 Aluchaideng..	453
Fig. 134c. Taohongbala culture, gold ornaments.	454
Fig. 134d. Taohongbala culture, gold crown, 1-4 Aluchaideng; 5 Nalingaotu	455
Fig. 134e. Taohongbala culture, silver objects.....	456
Fig. 135a. Yanglang culture, potteries.....	456
Fig. 135b. Yanglang culture, bronze objects	458
Fig. 135d. Yanglang culture, metal objects	459
Fig. 136. Chronological and cultural framework of the bronzes in northern China..	460
Fig. 137. The bronze objects in the Central Plains style found in Ningxia and east Gansu from the Shang to the Western Zhou period.	461
Fig. 138. The metal objects in the Central Plains style found in northern China during	

the Spring and Autumn period to the late Warring States	462
Fig. 139a. Xinjiang, copper and bronze objects: A Tianshanbeilu; B Yanbulake	463
Fig. 140a. Similar metal objects found in Xinjiang and the Eurasian Steppes,	465
Fig. 140b. Similar metal objects found in Xinjiang, Eurasian Steppes, and northern China	466
Fig. 140c. Xinjiang, metal objects similar to those in northern China,	467
Fig. 140d. Xinjiang, metal objects in local style.....	467
Fig. 140e. Bronze cooking ware-Fu and square plate found in Xinjiang, Eurasian Steppes, and northern China	468
Fig. 141a. Similar metal objects found in the Eurasian steppes and northern China.	469
Fig. 141b. Similar metal objects found in the Eurasian Steppes and northern China.	470
Fig. 142. Funeral objects from Afanasieva graves in southern Siberia and the Afanasievo-related objects from Altai and Xinjiang.	471
Fig. 143. Andronovo culture, pottery, bronze and stone objects.....	472
Fig. 144. Aga'ergen, Gongliu, Xinjiang, copper and bronze artifacts.	472
Fig. 145a. Bronze implements of Andronovo-type recovered in the Tacheng region, Xinjiang.....	473
Fig. 145b. Copper and bronze objects of Andronovo-type recovered in the central part of Xinjiang	473
Fig. 146. Karasuk culture, metal and pottery objects	474

Chapter 1 Introduction

1.1 The background to the rise of the archaeological research in northern China

Western scholars became very interested in the onset of Chinese metallurgy at the beginning of the twentieth century, when a number of bronze artifacts characterized by animal or geometrical patterns were discovered or collected in northern China¹. These bronzes consisted of weapons, tools, horse and chariot fittings and various kinds of personal ornaments. The majority of them were personal ornaments, such as earrings, finger rings, necklaces, belt hooks, buckles, plates, plaques, beads and so on. The personal use and possession of bronzes in northern China displays a sharp contrast to those of the Central Plain, in which the most typical bronze objects such as bronze vessels were communal in the sense that they were used during various rituals attended by members of the ruling elites².

As more and more archaeological excavations and expeditions were conducted in northern China, more cultures during the 4th and 3rd millennia B. P. in this area were identified, which share common cultural characteristics and display distinctive traits to those of the Central Plain. Therefore, the statement that the exquisite and amazing bronze techniques shown in the Central Plain were developed independently and were much earlier than those in other areas of China³ is severely questioned. The interest in the origins of Chinese civilizations aroused a new argument amongst scholars around the world⁴. Furthermore, Eurasia as a whole has been attracting considerable attention⁵. It has been acknowledged, that northern China may have played a pivotal role in the early Eurasian cultural interaction.

In the following sections, I will first review the previous studies on the bronzes in northern China; finally, I will outline the methods, scope, and goals of this monograph.

¹ Salmony 1933; Andersson 1932; Andersson 1933; Egami Namio/Mizunari Seiichi 1935.

² Pak Y. J. 1996, 2.

³ Barnard 1961, 108.

⁴ That the Chinese civilization developed through, and in large part because of the influence from West Asia is generally assumed among western scholars represented by Keightley (1983, xix-xx) and so on. Several scholars notably Chang K. C. (1963), strongly argued for the indigenous origins of Chinese civilization on the basis of a large number of new archaeological finds in China. Especially after the 1980s, as more early finds were made in the region outside the Central Plain. The traditional assumption that the Central Plain is a nucleus origin has been severely questioned, consequently the 'multi-centered origins' and 'Chinese interaction sphere' was put forward (Chang 1986, 234-244; Lin Y. 1986, 268-271; Linduff 1998, 133-145). Considering that the regional cultures outside the Central Plain may have independent developments, which connect between the Central Plain and the cultures in the contiguous areas, or even areas as far away as southern Siberia and Central Asia.

⁵ Chernykh 1992; Jacobson 1993; Genito 1994; Bunker 1997.

1.2 Previous studies of the bronzes in northern China

The research on the bronzes in northern China has excited great interest amongst scholars since the 1920s, which can be roughly divided into three phases: from the 1920s to the 1950s, from the 1950s to the mid-1970s, and from the middle 1970s.

1.2.1 From the 1920s to the 1950s

Even before the early 1920s, many expeditions into Xinjiang, Gansu, Tibet and the neighboring regions were conducted. These earliest expeditions in northern China have been summed up by a Korean scholar Pak Y. J. (Table 1)⁶.

Country	Season	Leader	Expedition area
Russia	1898-1899	D.A. Klementz	Turfan, Xinjiang
Sweden	1899-1901	S. Hedin	Loulan, Lop Nor in Xinjiang
Britain	1900-1901	A. Stein	Niya, Dandanwulike in Xinjiang
Germany	1902-1903	A. Grunwedel	Turfan, Kuche in Xinjiang
Japan	1902-1903	Otani Kozui	Kezi'er, Kumutula Grottos in Xinjiang
Germany	1904-1907	A. Grunwedel, A. von Le Coq	Turfan, Kuche, Hami, Yanqi, Bozikelike Grotto in Xinjiang
Japan	1905, 1908	Torii Ryuzo	Inner Mongolia, Manchuria
Britain	1906-1909	A. Stein	Niya, Dandanwulike, Loulan, Milan in Xinjiang, Tunhuang in Gansu
France	1906-1909	P. Pelliot	Bachu, Kuche; Kezi'er, Kumutula Grottos in Xinjiang; Tunhuang in Gansu
Japan	1906-1909	Otani Kozui	Turfan, Loulan in Xinjiang
Russia	1906-1909	P.K. Kozloff	Heicheng, Inner Mongolia
Japan	1910-1912	K. Orani	Kuche in Xinjiang, Dunhuang in Gansu
Britain	1913-1915	A. Stein	Xinjiang; Tunhuang in Gansu
Russia	1914-1915	S.F. Oldenburg	Xinjiang; Tunhuang in Gansu
France	1919	E. Licent	Linxi, Chifeng in Inner Mongolia
France	1920	E. Licent	Qingyang, Gansu
France	1922-1923	E. Licent, T. de Chardin	Salawusu, Inner Mongolia; Shuitonggou, Ningxia
Sweden	1923-1924	J. G. Andersson	Gansu, Qinghai
U.S.	1923-1924	L. Warner, H. Jayne	Heicheng, Inner Mongolia; Dunhuang in Gansu

Table 1. Foreign expeditions to northern China between 1898 and 1924 (after Pak Y. J. 1996, 8 Table 1.1).

Many of these explorers excavated prehistoric as well as historic sites. While the

⁶ Pak Y. J. 1996, 8.

expeditions to Xinjiang were more concerned with historical sites and transportable relics, those to Inner Mongolia and Gansu resulted in the discovery of Paleolithic, Neolithic and Bronze Age sites⁷. However, this kind of foreign expedition was akin to pillaging the historical remains from China, which was interrupted after the outbreak of World War I. The results of these expeditions nevertheless laid the groundwork for later systematic studies of prehistoric archaeological cultures in northern China.⁸

From the 1920s to the 1950s, archaeological expeditions to northern China were mainly undertaken by foreign archaeologists who began to cooperate with the Chinese authorities. Pak Y. J. has a review on most of the expeditions, surveys and excavations during this period in detail⁹. In addition, a small quantity of research papers, monographs and books have been published, which mainly put an emphasis on describing the bronzes discovered or collected in northern China¹⁰.

Furthermore, some researchers began to discuss the relationships of the Bronze Age cultures between the Central Plain, northern China, and outside of China. There were two different dominating views. One view was generally assumed among western scholars, that the bronzes discovered in northern China originated from the western cultures that influenced also the Central Plain. Nevertheless, the original area as previously suggested by western scholars differs as well. For example, M. Rostovezeff¹¹ believed that the earliest animal-shaped bronzes in northern China share the same root as those in Mesopotamia. However, A. Salmony¹² suggested that some kind of bronze ornaments imitated the forms of the samples from the Minusinsk Plain. While Japanese researchers such as Egami Namio and Mizunari Seiichi¹³ put forward that northern bronzes could be traced back to 500 BCE or so and originated from the Scythian area around the Black Sea, then spread from west to east. The statement 'the main complex of Suiyuan bronzes is contemporary with the late period of the Karasuk culture' proposed by G. Ecke¹⁴ who also believed that the animal style of the Yin Dynasty in the Central Plain came from northern Eurasia, is in contrast with the opinion that Suiyuan bronzes originated from the Seima-Turbino culture, which is put forward by M. Loehr¹⁵. In addition to this, M. Loehr pointed out that the bow-shaped wares could have possibly been influenced by the Karasuk culture, and even that the bronze metallurgical techniques were spread from the west through Siberia or

⁷ Pak Y. J. 1996, 7.

⁸ Pak Y. J. 1996, 7.

⁹ Pak Y. J. 1996, 8-15.

¹⁰ Andersson 1925; Andersson 1933; Andersson 1943; Salmony 1933; Bergman 1939; Egami Namio/Mizunari Seiichi 1935.; Yawata Ichiro 1935; Yawata Ichiro 1940; Liang S. Y. 1933, 1-44.

¹¹ Rostovtzeff 1922; Rostovtzeff 1929.

¹² Salmony 1934.

¹³ Egami Namio/Mizunari Seiichi 1935.

¹⁴ Ecke 1943.

¹⁵ Loehr 1949, 126-144.

Xinjiang. Finally, on the basis of the comparison of the Ordos short swords and knives, he emphasized that many elements shown in the bronze cultures of northern China and the Central Plain were exported from outside¹⁶. Borodino¹⁷ puts forward that images of elk and waterfowl were prevalent in the Seima-Turbino culture, but images of horse and buck were absent which existed in the Yin culture. Furthermore, he raised the point that both of the animal-headed bronze knives in Europe and China come from Siberia.

On the other hand, a few scholars¹⁸ are inclined to claim that the bronzes found in northern China originated from the Shang culture. For instance, B. Karlgren points out that animal-headed and loop-headed knives, animal-headed swords, hollow-handled axes and bow-shaped wares were all influenced by the Yinshang culture, which also influenced the Karasuk culture and spread through Ordos, Suiyuan, Mongolia and the Yenisei regions, even reaching as far as Scythia in the south of Russia. Li Ji states that the bronzes discovered at Yinxu resemble those found in Siberia, and it was only after the Yinshang Dynasty that such kind of animal-shaped bronzes at Yinxu were becoming popular in northern China.

Only a small number of scientific excavations were carried out in northern China during the 1920s to the 1950s. The majority of the bronzes that were mainly collected from the surface, therefore lack information of a cultural nature and associated correlation. Thus, most of the western scholars analyzed them based on the chronological system of western cultures; as a result, the research was more or less limited in depth. In any case, the designation of *Suiyuan bronzes*¹⁹ and *Ordos bronzes*²⁰ indicate that the special individuality and traits of such bronzes were evidently recognized.

1.2.2 From the 1950s to the mid-1970s

Notably the establishment of the People's Republic of China in 1949 made a great push towards archaeological work in northern China, which led not only to stricter fieldwork, but also to further research. A significant number of sites were discovered and investigated, such as Xituanshan²¹, Chifeng²², Shiertaiyingzi²³, Zhizhushan²⁴, Nanshan'gen²⁵, Shuijiangoumen²⁶, Sujigou²⁷, Huangniangniangtai²⁸, Dahezhuang²⁹

¹⁶ Loehr 1951, 77-162.

¹⁷ Borodino 1957.

¹⁸ Yetts 1925; Yetts 1939; Karlgren 1949; Li J. 1929; Li J. 1933; Li J. 1949; Gao Q. X. 1945.

¹⁹ Andersson 1929, 149; Egami Namio/Mizunari Seiichi 1935.

²⁰ Andersson 1932, 224.

²¹ Tong Z. C. 1964, 29-49.

²² Lü Z. E 1958, 25-40.

²³ Zhu G. 1960, 63-71.

²⁴ ZSKKN 1979, 215-243.

²⁵ LNZ et al. 1973, 27-38.

²⁶ Zheng L. 1965, 50-51.

and so on. A few important bronze cultures were also identified in northern China. Most of the important archaeological fieldwork and their related contribution have been well summarized and reviewed by Pak Y. J. region by region³⁰, so it will not be repeated here.

With growing information available on the bronzes in northern China based on archaeological fieldwork, previous viewpoints about the origin of the bronzes in northern China were questioned and changed. For example, K. Jettmar³¹ stated that the animal-shaped bronze artifacts could have been imported from the Baikon region, and then returned to the northern area with the advanced metallurgical techniques. Soviet scholar, С. В. Киселёв³² who once supported the opinion of a western origin for the northern bronzes turns to believe that some bronzes of the Karasuk culture originated from China. However, it was not the Yinshang people but the people living in northern China that transferred to the Minusinsk Plain, then integrated with the indigenous people, consequently created the Karasuk culture. This is reflected in the close similarity of the bronzes, potteries and the decoration style between the Karasuk culture and cultures distributed around north of the Chinese Great wall, especially in the Ordos, Suiyuan and Rehe regions³³. In addition to the issue on origin, the relative chronology between western and eastern cultures also attracted significant attention among scholars.

It is worth mentioning that Chinese scholars began to do some research work during this period as well. In this respect, a leading Chinese archaeologist at that time, Gao Quxun³⁴ insisted that the animal-headed knives, bow-shaped artifacts, long hollow-handled axes and bronze daggers in the Karasuk culture were influenced by the Yinshang culture, and the bronze daggers were without doubt of Chinese style. Another scholar, Tang Lan³⁵ explained the function of the bow-shaped artifacts.

Conclusively, on one hand, many important sites as well as some vital bronze cultures were found and confirmed³⁶. On the other hand, the discussion on the distribution, chronology, and periodization of these bronze cultures has not been furthered. By contrast, the research work was much more scientific when compared to the previous studies undertaken. In addition, western scholars, especially soviet scholars still

²⁷ Gai. S. L. 1965, 44-46.

²⁸ GSB 1960c, 53-71; GSB 1978, 421-448.

²⁹ HHGS 1960, 9-12; ZKK 1974, 29-62.

³⁰ Pak Y. J. 1996, 16-22.

³¹ Jettmar 1950, 22.

³² Киселёв 1951.

³³ Киселёв 1959, 302-314.

³⁴ Gao Q. X. 1958, 658-719.

³⁵ Tang L. 1972, 178-184.

³⁶ Including the Lower Xiajiadian, Xindian, Siwa, Shajing cultures and so on.

carried out the majority of the research work with the exception of one part being undertaken by Chinese scholars.

1.2.3 From the middle 1970s

Despite the fact that the archaeological fieldwork was broken off abruptly by the Cultural Revolution (1966-1976), the continuous accumulation of new archaeological data in northern China³⁷ from the middle of the 1970s to this day is quite remarkable. The research entered a new flourishing phase accordingly, which can be reflected upon in the following aspects.

Firstly, during the 1960-1970s, with the birth and development of the New Archaeology³⁸, a contrasting tendency arose to stress the internal processes and independent origins of cultures rather than focusing on an outside influence³⁹. The shift in theoretical orientation was also seen in the studies of the bronzes in early China⁴⁰. The theories of multi-centered origins and indigenous origin came into being. The latter became characteristic of the mainstream thought amongst sinologists, represented by Wu En⁴¹, Tian Guangjin⁴², Lin Yun⁴³ and so on⁴⁴.

Secondly, some scholars turned their interest to certain types of bronze artifacts, especially the animal-shaped plaques or animal motifs⁴⁵. In addition, almost every type of bronze artifact was researched thoroughly and systemically, such as bronze cooking ware-Fu⁴⁶, bronze swords⁴⁷, bronze mirrors⁴⁸, bronze knives⁴⁹, bronze axes⁵⁰, horse gag bits⁵¹, bow-shaped artifacts⁵², bronze plaques⁵³ and so on. The

³⁷ Pak Y. J. (1996, 19-23) summarized the important archaeological discoveries in northern China from the middle 1970s until the middle 1990s.

³⁸ For a discussion on the development of the New Archaeology, see Tregger 1989, 289-328 and Binford 1968, 5-28.

³⁹ Renfrew/Bahn 1991, 34-35.

⁴⁰ MJJ 2000, 1-2.

⁴¹ Wu E. (1985, 135-155) put forward that the formation of the Karasuk culture is later than the Yinshang culture, so it is impossible that bronze cultures in northern China originated from the Karasuk culture.

⁴² Tian G. J. (1997b, 266-307) stated that the development of bronze cultures in northern China is in one continuous line. An abrupt change in the weather from warm and humid to dry and cold brought on the corresponding sharp economic shift from agriculture to pasturage and nomadism. Hence, the steppe bronze cultures are characterized by the Ordos bronzes.

⁴³ Lin Y. (1998a, 331-334) stated that the birth of the northern bronzes could be traced back to the Erlitou culture. Meanwhile, he seriously questioned the views either of a western origin or of a Central-Plains-centered origin.

⁴⁴ For a review about the "multi-centered" origins and indigenous origins, see MJJ 2000, 1-2.

⁴⁵ Wu E. 1981, 45-61; Tian G. J. 1986, 203-219; Du Z. S. 231-408; Guo S. X. 1993, 89-96.

⁴⁶ Gu Z. J. 1986, 19-22; Liu L. 1987, 60-65; Bunker 1992b; Feng E. X. 1993, 318-328; Takahama Shyu 1983; Bo Y. W. et al. 1995, 14-19; Li X. Q. 1998; Guo W. 2002; Zhu R. X. 2000, 10.

⁴⁷ Wu E. 1978, 324-333; Lin Y. 1998a, 331-334; Chi L. 1982, 54-59; Jin F. Y. 1982/1983; Takahama Shyu 1983; Zheng S. Z. 1984, 34-79; Zhai D. F. 1988, 277-300; Liu B. 1992, 21-25; Zhu Y. G. 1992, 65-72; Tao Z. Y. 1994; Song Z. M. 1997, 50-59; Han J. G. 1996, 154-176; Tong Z. C. 2001, 46-54.

⁴⁸ Zhang X. Y. 1986, 163-172; Song X. C. 1997, 147-169.

⁴⁹ Ordos 86; Yu Q. 1991, 12-18; Zheng S. Z. 1994, 24-48.

⁵⁰ Qi X. G. 1994; Yu J. H. 1996, 22-28.

⁵¹ Zhai D. F. 1984, 296-316.

⁵² Lin Y. 1998a, 331-334; Tang J. H. 1993; Wu E. 1994a, 27-30; Lin Y. 1998b, 251-261.

⁵³ Ordos 86; Zheng S. Z. 1991, 1-32.

related research included not only characters, chronology and the distribution of the artifacts but also their origins and spreading process. Nevertheless, such research on a single bronze artifact makes it difficult for the readers to tell how this bronze artifact is related to the other bronze artifacts. The lack of an archaeological context and assemblage information also makes it hard to judge its importance and function within an area or a culture.

Thirdly, the study of various regional cultures was carried out in order to emphasize the archaeological heritage of each region. For instance, Zhong Kan and Han Kongle did a study on the classification and characteristics of the bronzes found in the Guyuan region, Ningxia during the Spring and Autumn and the Warring States period. They suggest that the bronze cultures in south Ningxia may be indigenous cultures, though influenced by the Zhou and Qin cultures, and similar to the neighboring Ordos cultures⁵⁴. Besides, another Chinese scholar Luo Feng⁵⁵ furthered the above views that the Eastern Zhou period of bronzes found in the Guyuan region have not only the main characteristics of the northern bronzes but also strong local traits based on the number of bronzes found in this region. Some regions within northern China have been treated as different cultural units, including the Ordos region, Liaoxi region, south Shaanxi, west Shanxi, Dalinghe region, Gansu and Ningxia region, Chifeng region, north Hebei and so on⁵⁶. Such a study concentrates on the divisions between different stages within a whole period as well as on the relations, especially coexistence within the archaeological culture. While, rarely has any such study inspected the local culture from the point of view of either the entire northern China or the whole Eurasian Steppe, therefore it fails to see the cultures from a larger background⁵⁷.

Fourthly, the discussion about the relationship between northern bronze cultures, western cultures and the Central Plain cultures has been much more probed on the basis of the comparison of similar bronzes⁵⁸. This type of study combines the research about the Xiongnu people mentioned in written records with other forms of historic records, comparing it with related foreign artifacts. Nevertheless, the research still needs to understand the make up of the Xiongnu tribes—the central authority of the Confederation established by Modu (冒顿) and the differences between all those groups, which were once separated before they amalgamated. To do this, we need more research on the correlations between different archaeological cultures during the

⁵⁴ Zhong/Han 1985, 203-231.

⁵⁵ Luo F. 1990, 743-750.

⁵⁶ The review of the regional cultural research in northern China has been quite elaborated upon by Li Hairong (2003, 7-9).

⁵⁷ YJH 2004, 204.

⁵⁸ Wu E. 1978, 324-333; Wu E. 1984, 46-58; Wu E. 1985; Wu E. 1986, 135-155; Wu E. 1994a, 27-30; Tian G. J. 1983, 7-24; Tian G. J. 1986, 203-219; Lin M. C. 1998; Li H. R. 2003.

Spring and Autumn, and Warring States period in the northern cultural zone of China and in the Steppes cultures further north⁵⁹.

Fifthly, the scientific examination of the metallurgical technique as well as the availability of a wide range of chronometric dating techniques, including radiocarbon dating provided an opportunity for scholars to distinguish earlier archaeological data from the Central Plains and western cultures. Scholars used both the optical microscope and scanning electron microscope or energy-dispersive X-ray fluorescence analyzer to determine the microstructure of the artifacts, which provided a direct insight into the techniques used in their manufacture. This data provided significant evidence that allowed the comparison between the metallurgical technologies of the different culture⁶⁰. Most of these analyses focused on the chemical components and metallurgical structure.

Except for the aforementioned studies, much comprehensive and systematic research has also been carried out from archaeological findings since the early 1990s⁶¹. At the end of the 1990s, western scholars were starting an overall research of the entire cultural zone⁶². Chinese scholars started to look at the northern bronzes in China against the background of the entire Eurasian Steppe⁶³. However, due to a lack of research on the division of different stages within the Spring-Autumn period and Warring States period, these types of studies look upon all the remains of the Eastern Zhou culture in the whole area as a unit, thus depriving us of the possibility to understand the dynamic development and different cultures in this region.

In addition, some topics need to be further researched, such as the subsistence of the bronze-using cultures in northern China, and the social organization of societies in different parts of northern China. Nevertheless, some scholars have dealt with such topics. For instance, Pak Y. J. did a case study on the Yuhuangmiao cemetery in order to reconstruct the social organization and discuss the social stratification and subsistence of the economy⁶⁴.

It is worth mentioning here that the Chinese concept of archaeological culture is descriptive rather than explanatory. Any attempts to reconstruct human behavioral aspects of the past, to delineate the cultural process or to interpret the meaning of archaeological remains, are relatively rare. It seems that in addition to the conventional traditional 'normative' view, more diverse approaches to 'archaeological culture' are in great demand among archeologists in China, in order to broaden the

⁵⁹ YJH 2004, 204.

⁶⁰ For a review about the metallurgical research on the northern bronzes, see Li. H. R. 2003, 15-16.

⁶¹ Lin Y. 1998d, 368-387.

⁶² Miyake Toshihiko 1999.

⁶³ Wu E. 2002, 437-470.

⁶⁴ Pak Y. J. 1996, 415-466.

perspective on the prehistoric societies of China⁶⁵.

1.3 Scope of this study

1.3.1 The temporal scope

The time from the 4th to the 3rd millennia B. P. is approximately parallel to the period of the Xia⁶⁶, Shang and Zhou dynasties in the Central Plain. Whether the Xia Dynasty existed is not the issue here. However, most of the Chinese scholars are used to giving a relative dating, namely the corresponding period of the Xia, Shang and Zhou dynasties in central China to the cultures even though they are situated outside the Central Plain. Therefore, the term ‘Xia’ will still be used in this study, not only for the scholars who hold the traditional views on the earliest Dynasty in China but also for helping normal readers to better understand the northern bronze cultures within the resplendent background of the Central Plain. Therefore, it is necessary to make a brief introduction to the time range of the Xia, Shang, and Zhou Dynasties.

The relationship between the Xia Dynasty and the Erlitou culture has been long argued amongst scholars who believe that the Xia Dynasty existed. Whether the first stage of the Erlitou culture is parallel to the period of the earliest Xia Dynasty is still questioned⁶⁷, however, it is widely accepted that the Erlitou culture can be divided into four stages⁶⁸. Therefore, in this study, the radiocarbon dates of the beginning and end of the Erlitou culture⁶⁹ will be quoted to compare with the period of the Xia Dynasty despite that the very beginning of the Xia Dynasty was dated to 2070 BCE by the expert team of the project on dating the Xia, Shang, and Zhou dynasties⁷⁰. Accordingly, the Xia period is parallel to 1900-1600 BCE in this study (Table 3).

The chronology of the Shang period from 1600 to 1046 BCE is in no doubt. However, on the periodization of the Shang Dynasty, there are many different views. Zou H.⁷¹ divides the Shang cultures into three stages: Pre-Shang, Early Shang and Late Shang. Later, Li Boqian⁷² ascribes the Xiaqiyan culture to the Pre-Shang period, which was widely accepted. Some scholars put forward that the Shang cultures in the Shang Dynasty should be divided into three such phases: Early Shang, Middle Shang⁷³ and

⁶⁵ Pak Y. J. 1996, 24.

⁶⁶ Whether the Xia Dynasty existed or not is a hot topic amongst scholars.

⁶⁷ A: Zou H. (2001b, 89-170) stated that the Erlitou culture I stage represents the early Xia Dynasty or early Xia culture.

B: Li B. Q. (1986, 41-47; 2000, 11-14): the Erlitou culture I stage is not equal to the earliest Xia culture; the Erlitou culture I-IV stage represents the period from “Houyi (后羿)” to “Jie (桀)”.

C: ZSKK 2003.

⁶⁸ Erlitou 99, 28-33.

⁶⁹ Qiu S. H. et al. 1983, 923-928.

⁷⁰ Duandai 2000, 86-88.

⁷¹ Zou H. 2001c, 29-86.

⁷² Li B. Q. 1998a, 78-90.

⁷³ When “Middle Shang” ended is still in dispute.

Late Shang⁷⁴. However, the cultural content and chronological framework of the Middle Shang as stated by Tang Jigen⁷⁵ is equal with the IV, V, VI stages of the Early Shang put forward by Wang Lixin⁷⁶. Therefore, the new concept of the “Middle Shang” made no essential differences in cultural content with the previous periodization of Early Shang and Late Shang. Besides, the sub-division of Early Shang and Late Shang is still controversial⁷⁷ (Table 2). In short, this study prefers to use the two-phase chronology for the Shang period (Table 3).

Though Chinese scholars still argue for the periodization of some typical Western Zhou sites⁷⁸, dividing the Western Zhou Dynasty (1046-771 BCE) into early, middle and late three stages, has been largely accepted (Table 3). Besides, the Eastern Zhou period is marked as the Spring and Autumn period (770-475 BCE) and the Warring States (475-221 BCE).

As mentioned above, the period from the 4th to the 3rd millennia B. P. being regarded as the period of the Xia, Shang and Zhou dynasties in central China is in agreement. However, in terms of archaeology, whether northern China had entered the Iron Age after the fourth century BCE is still in dispute. Lin Yun suggests that northern China during the Warring States period (475-221 BCE) belonged to the Bronze Age because the bronze weapons which are regarded as the landmark of the Bronze Age were still utilized in great numbers at that time, though a considerable quantity of other iron objects were in use as well. According to his opinion, the Bronze Age lasted until the Qin period⁷⁹ or even the Han period⁸⁰. While some scholars represented by Wu En state that the appearance of lots of iron tools and weapons should signify the rise of the Iron Age, though bronze tools and weapons were still in use at the same time. Hence, he puts forward that the cultures in northern China entered the early Iron Age instead of the Bronze Age after the late Spring and Autumn period. This study prefers to agree with the opinion of Lin Yun because the bronze tools and weapons had not disappeared when the iron objects, which are similar in form to the bronze objects came into being. Accordingly, this study will discuss the ‘bronze’ cultures in northern China.

⁷⁴ Tang J. G. 1999, 393-420; ZSKK 2003; Wang Z. Z. 2006, 44-49.

⁷⁵ Tang J. G. 1999, 393-420.

⁷⁶ Wang Lixin, Cong Songshan nanbei de wenhua zhenghe kan Xia wangchao de chuxian 从嵩山南北的文化整合看夏王朝的出现 (Discussion on the birth of the Xia Dynasty from the cultural interaction in the south and north of Songshan). It is not yet published. Wang Lixin is a young scholar who works at Jilin University.

⁷⁷ The doctoral dissertation: Taihangshan liangyi beifang qingtong wenhua yu Xia Shang Xizhou wenhua de hudong guanxi 太行山两翼北方青铜文化与夏商西周文化的互动关系 (The interactive relations between the Northern bronze cultures along the Taihang Mountain and Xia, Shang and Western Zhou cultures) by Jiang Gang (2006) who studied in Jilin University is not yet published. He sent me the electronic version of his doctoral dissertation via the Email shortly before he printed it. Therefore, the pages I mentioned in this study may be a little different with the printed version. He made a review on the views about the periodization of the Shang Dynasty.

⁷⁸ Fengxi 62; Zhangjiapo 99; Liulihe 95.

⁷⁹ The Qin Dynasty is from 221 to 206 BCE.

⁸⁰ The Han Dynasty followed the Qin Dynasty, from 206 BCE to AD 220.

	Pre-Shang			Early Shang			Late Shang						
	1 stage			2 stage		3 stage		4 stage		5 stage		6 stage	
Zou H. 2001a, 2001b	I: Lower Jiagou	II: Erligang C1H9	III: Nanguan, Erligang C1H17	IV: Upper Erligang C1H2	V: Upper Erligang C1H1	VI: Upper Baijiazhang	VII: Taixi	VIII: Yinxu I	IX, X Yinxu II	XI, XII Yinxu III	XIII, XIV Yinxu IV		
ZFH 95.								YinXu I	YinXu II	YinXu III			
Zheng /Chen 1985								I	late				
Wang L. X.													
ZSKK 2003													
Jiang G. 2006													

Table 2. Different periodization of the Shang Dynasty (adapted from Jiang G. 2006, 3 Table 1.1)⁸¹.

⁸¹ Wang Lixin , Cong Songshan nanbei de wenhua zhenghe kan Xia wangchao de chuxian 从嵩山南北的文化整合看夏王朝的出现 (Discussion on the birth of the Xia Dynasty from the cultural interaction in the south and north of Songshan). It is not yet published. Wang Lixin is a young scholar who works at Jilin University

Xia Dynasty <i>Ca.1900-1600 BCE</i> ⁸²	Early period: Erlitou I, II	
	Late period: Erlitou III, IV	
Shang Dynasty <i>Ca.1600-1046 BCE</i>	Early Shang <i>Ca.1600-1251 BCE</i> ⁸³	I: <i>Ca. 1600-1500 BCE</i>
		II: <i>Ca. 1500-1400 BCE</i>
		III: <i>Ca. 1400-1251 BCE</i>
	Late Shang <i>Ca.1251-1046 BCE</i>	Early stage: Wuding---Zujia(武丁—甲组) Late stage: Bingxin---Dixin(癸辛—帝辛)
Zhou Dynasty <i>Ca.1046-221 BCE</i>	Western Zhou <i>Ca.1046-771 BCE</i>	Early stage: Wuwang—Zhaowang(武王—昭王)
		Middle stage: Muwang—Xiaowang(穆王—孝王)
		Late period: Yiwang----Youwang (夷王—幽王)
	Eastern Zhou <i>Ca.770-221 BCE</i>	The Spring and Autumn period <i>Ca.770-475 BCE</i> The Warring States <i>Ca.475-221 BCE</i>

Table 3. The chronological framework of the Xia, Shang and Zhou dynasties.

1.3.2 The spatial scope

Northern China is strategically located at the crossroads between the east and the west. It lies in the south-easternmost part of the Eurasian Steppe, bordered by the heartlands of the Central Plain to the south (Map 1). This area is where ancient central Chinese people could meet, contact and communicate with the northern nomadic people, namely the agricultural and pasturage interactive belt. The crucial importance of this region for the prehistoric period, and specifically for the Bronze Age has now come to be recognized.

1.3.2.1 The geographical range of northern China

The term ‘northern China’⁸⁴ indicates neither the whole area outside the Central Plain, nor all the regions in the north and east of the Central Plain in the general sense, but specially denotes the frontier belt along the Great Wall of China built mainly during the Qin and Han Dynasties, approximately between N 32°- 43°and E 95°-125°.

⁸² Qiu S. H. et al. 1983, 923-928; Duandai 2000.

⁸³ The dates from the early Shang to the Western Zhou are all quoted from the expert team of the project on dating the Xia, Shang and Zhou Dynasties.

⁸⁴ Many scholars prefer to use the term *northern zone*.

It is bounded on the east by the Xiliaohe and Xilamlunhe⁸⁵, through the Yanshan, on the west by the Helanshan, on the north by the Yinshan, and on the south by the Weihe (Map 1). It is at present divided into several administrative units, including the southeast and middle-south of Inner Mongolia, north Hebei, north Shanxi, north Shaanxi, Ningxia, Gansu and northeast Qinghai and west Liaoning.

1.3.2.2 The geographical environment of northern China

Geomorphological features are quite complicated in northern China, including mountains, plateaus, rivers and deserts. The direction of the mountains and position of the high plateaus construct the important geographical barriers and distinctive features in this region (Map 1). The Yinshan in middle Inner Mongolia stretches from the west to east, forming a natural barrier between the southern Gobi desert and the north Yellow River. The Yanshan is a major mountain range lying north of the North China Plain in the northern Hebei Province, and it is an important traffic gateway between the north and the south. The Helanshan is a mountain range, forming the border of Inner Mongolia and Ningxia, stretching from the north to the south. The Taihangshan is a mountain range running from the Northeast down the eastern edge of the Loess Plateau in the Henan, Shanxi and Hebei provinces. The range extends over 400 km from north to south and has an average elevation of 1,500 to 2,000 meters. The Qilianshan is a northern outlier of the Kunlun Mountains, forming the border between the Qinghai and Gansu provinces of northern China. The range stretches from the south of the Dunhuang some 800 km to the southeast, forming the western border of the Gansu Corridor.

The Inner-Mongolia Plateau, the Ordos Plateau, and the Loess Plateau are all 1000-2000 meters above sea level. On the borders of these plateaus are mountains with elevations of more than 3000 meters, such as the Taihangshan on the eastern margin of the Loess Plateau. Between these Plateaus are a numerous series of hills and mountains, generally with elevations of 500-1000 meters. Forests, grasslands, and deserts are scattered between these mountain ranges, plateaus, and rivers of northern China.

Northeast China is relatively better watered by large and small rivers. In addition to the Liaohe, Dalinghe, Luanhe rivers, small rivers are located in the northeast and the middle reaches of the Yellow River and its tributaries lie in north-central and northwest China. A few perennial inland rivers are fed by snow and ice melting from the high mountains during the warm seasons. All inland rivers flow into saline inland

⁸⁵ *He* as suffix means river; *Shan* as suffix means hill or mountain.

lakes or die away in Sandy deserts or salt marshes⁸⁶.

As for the climate concerned, northeast China is characterized by moderate and semiarid, the Inner Mongolian region by moderate and arid, and the northwest by arid and deserts. It is believed that the distinctive environmental conditions of northern China have played a vital role in setting apart this region culturally from its neighboring region to the south. It is highly probable that the climate which includes temperature, precipitation, latitude, topography, monsoon, wind, sand and geomorphological features affected human activities greatly. Pak Yangjin makes a comprehensive introduction to the climate in northern China (Map 3; Map 4; Map 5; Map 6)⁸⁷.

The unique physical and biological components of the environment in northern China may be conducive to the formation of the distinctive archaeological cultures in this region. However, the adaptation to its environment by each individual society in each ecological zone varies greatly from one to another⁸⁸.

1.3.3 Three Subregions and complexes

According to the differences of the geographical characteristics and cultural aspects, northern China is normally divided into different sub-regions. Of course, scholars have not agreed with each other about the spatial and cultural range of these sub-regions. Pak Yangjin divides northern China into three complexes: the Northwest Complex, North-central Complex and Northeast Complex. It is worth mentioning that the designation of 'complex' is heavily influenced by the culture-classificatory theory proposed by Su Bingqi, who is one of the leading figures in modern Chinese archaeology, and plays a significant role in the advancement of archaeological theories and methodologies regarding the typology and classification of archaeological cultures. It was in his article that he first put forward in written form the basic idea of the regional typology of archeological cultures. He writes: in order to conduct classification of the region (Qu 区), complex (Xi 系), and type (Leixing 类型) of archaeological cultures, colleagues in each area must rely on the local archaeological work, and make efforts to clarify cultural features and their relationship. By selecting a few representative sites and conducting a scientific excavation of them, one can acquire representative material remains for an analysis. Afterwards, on the basis of the classification of cultural types, and similarities and differences of cultural characteristics within a relatively large area, one can deduce systems of cultures. Here a region is a chunk, a complex is a stem, and a type is a branch. After certain amounts of effort, we will have important breakthroughs and

⁸⁶ Pak Y. J. 1996, 31-32.

⁸⁷ Pak Y. J. 1996, 35-47.

⁸⁸ Pak Y. J. 1996, 40.

results on the issue of the region, complex, and type⁸⁹. This paper follows the usage of 'complex' in his opinion.

This study also divides northern China into three sub-regional and cultural complexes: the Northwest Complex, North-central Complex, and south of the Yanshan Complex, which differs with Pak Yangjin in some spatial range and cultural ascription.

The North-central Complex is almost equal to the definition by Pak Yangjin in spatial range, centered itself in the south and middle of Inner Mongolia, Ningxia, and the Qingyang region in Gansu. It is represented by the bronzes with animal patterns, namely so called 'Ordos Bronzes' or 'Northern Bronzes' (Map 2)⁹⁰.

In terms of the cultural classification by Pak, the bronze cultures identified from northern Hebei and Beijing in the south, to the Heilongjiang province in the north, are ascribed to the Northeast Complex; administratively, it includes the Heilongjiang, Jilin and Liaoning provinces⁹¹. As we know, the Northeast Complex is famous for its widespread use of bronze daggers with curved blades that differ to the typical Ordos bronze daggers with straight blades. This type of bronze dagger has been discovered not only in the bronze cultures in northeast China⁹² but also in the Korean Peninsula and Japan⁹³. Therefore, this area characterized by bronze swords with curved blades is ruled out in this study.

South of the Yanshan Complex, centered in the south of the Yanshan region, includes the bronze-using cultures distributed mainly within the north Hebei region and the Beijing and Tianjin regions, almost corresponding to the south of the Northeast Complex which is defined by Pak. Its peculiarity has been long ignored in previous research and has attracted more interest amongst scholars in recent decades. Therefore, it will also be an emphasis in this paper.

Here the Northwest Complex is centered in the Hexi Corridor, administratively including the north and middle of Gansu, and the north of Qinghai, however, the Xinjiang region is excluded as it has its own special pottery assemblage, burial patterns, and bronze artifacts, which seem to have more connections with central Asia and south Siberia.

With increasing fieldwork, dozens of bronze cultures have been identified and

⁸⁹ Su/Yin 1981, 11. The translation is quoted from Pak Y. J. 1996, 49-50.

⁹⁰ The definition of 'Ordos Bronzes' and 'Northern Bronzes' will be explained in the following sections.

⁹¹ Pak Y. J. 1996, 54.

⁹² Such as the Upper Xiajiadian culture, Xituanshan culture, Lower Xiajiadian culture and so on.

⁹³ Jin F. Y. 1982/1983, 39-54.; Lin Y. 1998a, 311-334; Wu E. 1978, 324-333; Zhai D. F. 1988, 277-330; Zheng S. Z. 1984, 37-49.

researched in these sub-regions of northern China. Of them, the bronze cultures characterized by the ‘northern bronzes’ will be the main emphasis⁹⁴. The cultural aspects and bronze materials will also be an emphasis in this study.

1.3.4 ‘Ordos bronzes’ and ‘Northern bronzes’

The North-central Complex and south of the Yanshan Complex are characterized by the so-called ‘Ordos bronzes’. Originally, the term ‘Ordos’ was a geographical name given to the Steppe region, situated between the great loop of the Yellow River and the Great Wall in the Inner Mongolia-Shaanxi border. Bronze artifacts found from the Ordos Plateau drew much attention from Western, as well as Japanese and Chinese scholars. Here, it is necessary to have a brief introduction to the history surrounding, the so-called Ordos bronzes, which will help us to understand the following sections.

In the early 20th centuries, some special bronzes adorned with animal and geometrical motifs were discovered in Suiyuan and its neighboring area of Inner Mongolia. J. G. Andersson named them ‘Animal Style’ or ‘Suiyuan bronzes’.⁹⁵ In addition, Japanese scholars: Egami Namio and Mizunari Seiichi⁹⁶ continued to use the title ‘Suiyuan bronzes’. Furthermore, they put forward that these ‘Suiyuan bronzes’ were mainly found around the Suiyuan region, and had even arrived in areas along China’s Great Wall. However, Andersson reassigned them a new name ‘Ordos bronzes’ in 1932⁹⁷ because the majority of these bronzes were found in the Ordos region.

In fact, the greater amount of such bronze objects have been widely discovered not only in the Ordos or Suiyuan regions, but also in the broader area of northern China in recent decades. Consequently, Chinese archaeologist, Tian Guangjin named them ‘Ordos-style bronzes’⁹⁸ which enlarged its meaning to cover all the bronzes characterized by animal and geometric patterns discovered in China and Mongolia, and even including the northern Ural river district⁹⁹. His opinion is widely accepted, nevertheless, most scholars are accustomed to the old usage of ‘Ordos bronzes’, which in this case is equal to the ‘Ordos-style bronzes’.

Later, some archaeologists such as Wu En¹⁰⁰ and Lin Yun¹⁰¹ raised the titles “Northern Bronzes”, “Northern-style bronzes” and ‘Northern Complex’ to represent all bronzes characterized by animal motifs, which were distributed extensively in China,

⁹⁴ Some bronze cultures characterized by the Shang or Zhou style will be mentioned, but not as an emphasis.

⁹⁵ Andersson 1929, 149.

⁹⁶ Egami Namio/Mizunari Seiichi 1935.

⁹⁷ Andersson 1932, 224.

⁹⁸ Ordos 86.

⁹⁹ The new title ‘Ordos style bronzes’ is based on the original title ‘Ordos bronzes’ and the meaning of the former is much more elaborated upon by Tian G. J., which is mostly accepted. In spite of this, most scholars prefer to use ‘Ordos bronzes’

¹⁰⁰ Wu E. 1985, 135-155.

¹⁰¹ Lin Y. 1998c, 262-281.

Mongolia and the Ural region. These titles distinguish themselves from ‘the Central Plain style’ and ‘Northeast complex’ by literal meaning¹⁰². On the other hand, it emphasizes its differences in classification, forms, decoration, and artistic style with those of the Central Plain, as well as implying its close connection to similar bronzes in the whole Eurasian Steppe¹⁰³.

Actually, the earliest usage of ‘Northern Bronzes’ was put forward by Japanese scholars: Umehara Sueji¹⁰⁴ and Takashi Okazaki¹⁰⁵. It included the bronzes found not only in northern China but also in north Xinjiang, the Mongolia Plateau and Siberian region, which is approximately equal to the views stated by Lin Yun. However, if we consider the whole Eurasian Steppe as a unit, the title of ‘Northern bronzes’ does not seem to suit the larger background.

The term ‘Ordos culture’ or ‘Ordos bronzes’ used in this study is in accordance with the opinion by Pak, with a limited and narrow definition. ‘Ordos bronzes’ is applied to the late bronze age assemblages found in south central Inner Mongolia and its neighboring areas to the south. In contrast to the definition used by Tian Guangjin and other Chinese scholars, the ‘Ordos bronze cultures’ does not include the earlier ‘Northern-style bronzes’ during the late second millennia BCE. This is because the Northern-style bronzes have been found not only in south-central Inner Mongolia but also in northeastern and northwestern China during the late second millennia BCE, suggesting that the development of these bronzes was a pan-regional phenomenon and not limited to the Ordos Plateau¹⁰⁶.

The term ‘Northern bronzes’ or ‘Northern-style bronzes’ used in this study is equal to the definition by Lin Yun. In fact, the iron, gold, and silver objects characterized by this style are also included in this dissertation.

1.4. Aims of this study

The ultimate aim of this paper is to try and create a chronological and cultural framework of bronzes in northern China during the 4th and 3rd millennia B. P., so special attention is paid to the bronze information and cultural aspects in each complex.

Therefore, this study will first try to collect and present all the basic, objective, and complete information available on bronze objects site by site in northern China. The

¹⁰² Lin Y. 1998c, 262-281.

¹⁰³ Lin Y. 1998e, 289-295.

¹⁰⁴ Umehara Sueji 1938.

¹⁰⁵ Takashi Okazaki 1954, 12.

¹⁰⁶ Pak Y. J. 1996, 237.

catalogue, figures, and related cultural ascription of the bronze objects will be included. So far, no scholars have arranged these materials in this way, though they may have researched them. This is a basic work for a further study. In addition, all of the bronze information available on northern China will be mentioned in terms of the published archeological reports before 2008. Thus, the first aim of this study is to build a data bank for bronzes in northern China, which will help the scholars, especially western scholars who do not understand any Chinese, to better and more quickly grasp the relevant bronze information they need.

Secondly, most of the bronze cultures that have been identified and classified in northern China will be discussed; their distribution, chronology, periodization, cultural features, and origins, especially the bronze assemblage and metallurgical techniques of each culture will be analyzed.¹⁰⁷ Normally the metallurgical analysis is taken little account of by Chinese scholars. Therefore, the second aim is to outline the overall situation of bronze cultures in northern China, thus providing a full-scale and comprehensive background for western scholars to research the bronze cultures in the Eurasian Steppe as an entire unit. In addition, it is visible that the cultural framework of bronzes in northern China is dynamic and continuous in view of aforementioned research.

Thirdly, this study will try to describe how the bronze cultures developed in each complex, and how cultural complexes influenced or connected with each other at the different stages. This work will be based on the research of the bronze and pottery assemblages, burial practices and so on. An abundance of archaeological discoveries achieved in the past decades provides us with clues and evidence to commence new research. Compared with similar research by Pak in 1996, some improvements will be presented in this study. Firstly, some new bronze cultures will be added. Secondly, the cultural ascription of some sites and the definition of some cultures by Pak will be questioned and improved. Thirdly, more evidence based on pottery and bronze assemblages for periodization and cultural aspects of each culture will be supported. Fourthly, except for the traditional typological research, the archaeological context of bronze artifacts and available bronze metallurgical information will be used to analyze the development of the bronze metallurgy. Local economy models and society context will be briefly discussed as well.

In short, the third aim is to clarify the internal connections within the northern bronze cultures, and then the fourth is to explore the external relations, namely how northern China in this study was related to the Central Plain, Xinjiang region, and the Eurasian Steppe. Therefore, what kind of role northern China played during the 4th and 3rd

¹⁰⁷ Based on the articles available regarding the metallurgical analysis.

millennia B. P. in the progress of ancient cultural spreading and interaction will be revealed.

This monograph is also trying to outline the origins of the bronzes in northern China, which is quite a hot topic at present. Therefore, the earliest copper and bronze artifacts found in China, related metallurgical techniques, and cultural relations will be included.

Conclusively, this study intends to offer an insight into five specific problems based on the archaeological and archaeometallurgical materials available at present from northern China: 1) Where, when and what kind of bronzes began to be used in northern China? 2) What was the cultural context like for northern China during the 4th and 3rd millennia B. P.? 3) What kind of internal cultural connections existed in northern China? 4) What kind of external cultural connections and technological interactions existed between northern China and its neighboring regions during the 4th and 3rd millennia B. P.? 5) What is the origin of the bronzes in Northern China?

In order to answer these questions, a chronological and cultural framework of bronzes in northern China will be presented vividly. I hope it will not only enrich our knowledge of bronzes in northern China, but also contribute to a new perspective in understanding the early development of Chinese civilization within the whole Eurasian Steppe as a background.

Chapter 2 Discoveries of bronzes

In this chapter, I would like to present all of the information available on the bronzes site by site, on the basis of recent archaeological finds and research. Some ancient sites belonging to the Bronze Age however lack bronze artifacts, are temporarily not included.

2.1 Discoveries of bronzes in the Qinghai Province

Located at the northeastern edge of the Qinghai-Tibetan Plateau between ca 32° and 39° N and ca 90° and 103° E, the Qinghai Province is named after the biggest inland lake-Qinghai Lake. This is a region with a complex topography and hydrology. Mountain ridges and high plateaus elevating from about 2500 to 4500 meters above sea level dominate the region. The Kunlun and Bayanhar Mountains lie in the middle of the Qinghai Province; in the north lies the Altai and Qilian ranges; and in the south the Tanggula Mountain is situated. These mountains divide the whole region into three areas: the Qilian range, Qaidam Basin and the Qinghai-Nanshan (Qingnan) Plateau.

The Qilian range lies in the northeast of the Qinghai Province. The west Qilian, with an average altitude of 3500-meters is higher than the east. The Huangshui, Yellow River, and Datonghe rise in the east. The Qaidam Basin, lying to the northwest of the Qinghai Province, is the deepest part of the Qinghai-Tibetan Plateau with an average altitude of 2600-3100-meters. It was once an ideal place for expeditions because the ancient prosperous Silk Road stretched across it. Lying to the south of the Qinghai Province is the Qingan Plateau, which is rich in glaciers and mountains. The Yangzi River and Yellow river rise in these mountains.

The present climate is transitional from sub-humid to semi-arid, with the mean annual precipitation fluctuating between 250 and 600mm per year, resulting in a large water deficit. The main part of precipitation comes during May-September and is associated with the Pacific Monsoon. Up to 40% of the annual precipitation has been known to fall in a single storm. This, together with a spread of loess sediment and intensive land use has led to strong erosive activity in the region¹⁰⁸.

Due to its strategic location in the northwest of China, the research on the Bronze Age cultures in the Qinghai Province plays an important role for understanding the connections and interactive influences between the northwest, the Central Plain and the Eurasian Steppe. In the following section, the archaeological information available on the copper and bronzes found will be provided site by site.

¹⁰⁸ Xu X. G. et al. 2003, 85.

2.1.1 Hualong county

The Hualong county is located southeast of the Qinghai Province, 130 km north of Xining. Two important cemeteries belonging to the Kayue culture; Shangbanzhuwa and Xiabanzhuwa, have been excavated in the Hualong county.

2.1.1.1 Shangbanzhuwa cemetery

The Shangbanzhuwa cemetery, located in the north of the Xiongqian township, and west of Hualong county, was first excavated in 1988. Eighty-five graves of the Kayue culture, three bronze items, including one chisel and two knives as well as several hundred bronze bulbs were found together with 141 potteries and 98 stone wares¹⁰⁹.

One bronze knife and one bronze awl were found together in tomb M159 (Fig. 001, 1.9). Most of the bronze bulbs have a triangle section (Fig. 001, 2-7). The excavators thought the whole cemetery should be ascribed to the Kayue culture, which can be divided into two subtypes: Yellow River and the Huangshui Valley. In 1990, the second excavation of the Shangbanzhuwa cemetery was conducted. Sixty-two burials were found together with 98 complete copper and bronze artifacts out of 749 quite distinctive funerary goods¹¹⁰, consisting of 3 bells, 79 bulbs, 1 awl, 12 joined beads, 1 knife, 2 battle axes (Fig. 001, 10-17) and small fragments of bronze tubes, strips and plaques.

These 79 bronze bulbs, of different shapes and sizes, were laid diversely in the tombs, sometimes they were placed on the head of the skeleton, on the breast, between two legs, or near the feet. The two-shouldered battle-axe (Fig. 001, 17) seems to have been formed by cold forging because there are two mostly separated pages of bronze pieces. Another socketed battle-axe (Fig. 001, 16) was discovered with the remains of wood shaft in the socket.

The Yellow River type of the Kayue culture, represented by the Ahatela site, was traditionally considered to be characterized by an abundance of painted potteries dominated by two-eared pots with big mouths and ball-shaped pots. The two-eared pots with smaller mouths and abdomen-eared pots were used exclusively as funerary objects.¹¹¹

The Huangshui type of the Kayue culture, represented by the Shangsunjiazhai site, is characterized by pots without ear in the early period; the Tangwang-style-potteries¹¹² and a small quantity of single-eared bowls in the late period; and coarse pots existed continuously from start to finish. In addition, the deceased was normally placed in a

¹⁰⁹ QHY 1996, 27-44.

¹¹⁰ QHY 1998, 51-66.

¹¹¹ Xu/Ge 1988, 35-44.

¹¹² Tangwang-style-pottery represents one independent culture in the Hehuang valley, parallel to the Kayue culture, which was put forward by An Z. M. (1957, 23-51) according to one pottery group collected from the Chuanshan, Tangwang, and Dongxiang sites of the Gansu Province.

supine position, with a wood coffin in a one-sided shaft earth pit.

While the Shangbanzhuwa cemetery is characterized by single-eared bowls, and red coarse pots with raised strips or an incising decoration in the two ears, which are hardly seen in the Ahatela site. The deceased placed in a supine position were often buried in shaft-pit graves without a wood coffin, which is rarely seen in either the Shangbanzhuwa site or the Ahatela site. The pots without an ear in the Shangbanzhuwa cemetery appeared also in the early stage, while the red pots existed only in the beginning period, later replaced by a single-eared bowl. Besides, some potteries unearthed from the Shangsunjiazhai site show some similarities in how the ears were decorated, especially the raised strips and incising patterns.

By contrast, the Shangbanzhuwa cemetery shows not only similarities but also differences with the Yellow River type and the Huangshui type of the Kayue culture. It is hard to determine which subtype of the Kayue culture it should belong to.

2.1.1.2 Xiabanzhuwa cemetery

The Xiabanzhuwa cemetery lies south of the Xiongqian township. A total of 17 graves and about 300 funeral objects were found in two excavations during 1990 and 1994¹¹³, including over 10 bronze artifacts, consisting of 2 knives, 2 earrings, 11 bulbs, 2 joined beads, and one fragment (Fig. 002.). It is interesting to note that sixty bodies of the deceased were laid in the same direction, with all of the heads facing westwards. Accordingly, these graves may well be a cemetery of one group of people.

The excavators suggested that the cemetery should be assigned to the early Kayue culture in light of the funeral objects, which are inclined to show more similarities to the Ahatela type than the Shangsunjiazhai type.

Besides, in 1986, two bronze bulbs were found in the survey of the Suolatai cemetery in the Hualong county¹¹⁴. The pictures of them are not yet published

2.1.2 Gangcha county

One cemetery located 10km north of the Qinghai Lake and west of the Gangcha county, was excavated in 1989 and 1990¹¹⁵. In light of the funeral objects and burial convention, the excavators ascribed all of the 42 graves to the Kayue culture. Over 10 bronze artifacts were found, including one knife, one awl that had a bone shaft tube with six bone needles inside (Fig. 003, 1-3), buttons, and joined beads and so on.

Not only the funeral objects, such as the two-eared potteries, bronze wares and bone needles, but also the mortuary practice, especially animal sacrifice and the secondary burials, show similarities with those in the Kayue culture. The excavators ascribed the

¹¹³ Liu/Dou 1998, 3-11.

¹¹⁴ QHY 1991, 319.

¹¹⁵ Wang W. 1990, 15-21.

bronze knife (Fig. 003, 1) to the Kayue culture, although to which period of the Kayue culture is still uncertain.

In 1971, one tomb near the Buhuhe site was discovered together with one bronze tube (Fig. 003, 4). It is difficult to tell which culture it belongs to because too few accompanied potteries were found¹¹⁶.

2.1.3 Ledu county

The Ledu county lies east of Xining and the north bank of Huangshui. It was surveyed in 1982 and 1986¹¹⁷. About 29 ancient culture sites ascribed to the Majiayao, Qijia, Kayue and Xindian cultures were identified in the Hongshui village. In addition, one bronze arrowhead with a tubular handle was collected, and ascribed to the Xindian culture by the excavators (Fig. 004).

2.1.4 Ping'an county

The Ping'an county is situated northeast of Xining. Four tombs of the Bronze Age were excavated in 1998 at the Shaka village, the Gucheng township in the south bank of Huangshui, which is situated south of the Ping'an county¹¹⁸. Based on the potteries and bronze artifacts, the two-eared and long-necked potteries, bronze bulb (Fig. 005, 3) and other bronze ornaments found, the excavators suggested that these graves belonged to the Kayue culture.

Except for one secondary burial, the other three graves were all buried with animal bones, so it is possible to infer that animal husbandry perhaps prevailed during that period. In addition, one bronze bulb was also collected from the Xinzhuang site¹¹⁹.

2.1.5 Minhe county: Shanjiatou cemetery

The Minhe county is situated on the south bank of the Huangshui. The Shanjiatou¹²⁰ cemetery, lying east of the Hetaozhuang village, is one important Bronze Age site in the Minhe county. A total of 33 shaft-pit graves were found together with 69 potteries, 1 bronze hook (Fig. 006.), a few bronze bulbs, and some stones and bone wares.

The excavation of the Shanjiatou cemetery made a breakthrough in the archaeology of northwestern China, filling in the missing gap between the ancient cultures in the Gansu and Qinghai regions and providing valuable information for researching the mutual relations between them.

As for the mortuary practice presented in the Shanjiatou cemetery, the deceased were normally buried singularly, in rectangular-shaft-pit graves, in an extended and supine

¹¹⁶ Gu W. H. 1978, 69-70.

¹¹⁷ Wu H. X. 1994, 7-10.

¹¹⁸ QHY 2002a, 29-37.

¹¹⁹ DTJQH 1996, 13.

¹²⁰ Ge/Hong 1990, 10-15.

position as well as several secondary burials.

When comparing it to the other sites of the Xindian culture¹²¹, such as the Lianhuatai site in the Yongjing, Gansu Province¹²², the Liuwan site in the Yuedu county¹²³ and the Boji site in the Minhe county of the Qinghai province¹²⁴ and so on, the excavators viewed it as a special subtype of the Xindian culture.

2.1.6 Huzhu county

2.1.6.1 Zongzhai

Zongzhai¹²⁵ is the most important cemetery of the Bronze Age discovered in the Huzhu county, because 6 tombs of the Machang type, 10 of the Qijia culture and 1 of the Xindian culture were found, providing vital stratigraphical evidence. It is worthwhile mentioning that the Machang type tomb M38 was broken by the Qijia culture tomb M39, proving the supposition that the Qijia culture is later than the Machang type culture (Fig. 007b, 9). Furthermore, the difference resulted from gender or class in the Qijia culture has been reflected not only in the varieties of the funeral objects but also in the quantities. Besides, some forms and patterns of the potteries found at the Shangsunjiazhai cemetery and the Ahatela site of the Kayue culture are also seen in the Zongzhai site. Six bronze artifacts, identified as the Kayue culture, include two knives (Fig. 007a, 1.2) and four bronze wares compounded with a bone shaft (Fig. 007a, 3.4).

Conclusively, the tombs at the Zongzhai cemetery are vital for us to clarify the particular traits of the Qijia culture and the relations between the Qijia, Kayue, and Xindian cultures. In addition, some bronze bulbs were found at the Chengjiatai site in the Huzhu county¹²⁶, however the pictures are not yet available.

2.1.6.2 Fengtai

The Bronze Age settlement near the Fengtai village, 45km north of the provincial capital, Xining, was discovered by members of the Archaeological Institute of the Qinghai Province, during the course of systematic archaeological surveys in the early 1980s. It was declared a cultural heritage zone in 1986. Based on red grit tempered potsherds collected from the surface, the site was attributed to the Kayue culture.¹²⁷

In July 2000, the Archaeological Institute of the Qinghai Province guided an archaeological field excursion, for colleagues from the Archaeological Institute of the Chinese Academy of Social Science, and the Department of Eurasian Archaeology of

¹²¹ Xindian culture, one bronze culture in the Qinghai region, will be discussed in the following sections.

¹²² GSG et al. 1988, 7-20.

¹²³ Liuwan 84.

¹²⁴ Gao/Wu 1984, 30-33.

¹²⁵ QHWD 1986c, 309-317.

¹²⁶ DTJQH 1996, 95.

¹²⁷ Xu X. G. et al.2003, 87.

the German Archaeological Institute. The joint research team collected a large number of various artifacts attributed to the Kayue culture. The stratigraphical observations and richness of the stray finds led to the assumption that the Fengtai site is a well-preserved long-term dwelling place, providing sufficient archaeological substance to merit close examination¹²⁸.

Firstly, one important result from the excavation at Fengtai, suggests that the excavated part of the Bronze Age settlement existed for approximately 400 years, the last 200 years of the second millennia BCE and 200 years of the first millennia BCE (e.g. 1000±200 cal BCE). The radiocarbon dates obtained (Appendix) based on the East Profile (Fig. 020b) and West Profile (Fig. 020a) of Trench TG1, and the South Profile of Trench TG2 (Fig. 020c) helped to narrow down the time interval in which the Kayue culture is usually placed (Appendix). Both the sedimentary and chronology records correspond with each other, helping to divide the history of the opened settlement into two periods. The pottery complex supported this conclusion.

Secondly, three modes of house construction were found in Fengtai. The first mode is characterized by a steep slope with a large amount of ash, burned wood and pieces of mud-plaster as well as the absence of dwelling floors. This indicates a distinct mode of house constructed against the slope, which was laid out on two or more levels with timber being used as the main construction material (Fig. 020b). The second construction is quite different. The profiles show horizontal house floors with multi-layered mud and lime plastering (Fig. 020b, columns E.F; 020a, columns C-E about 2.7-2.9meters in depth). No postholes or any other traces of wall construction materials were found. The third architectural feature of the settlement was found in the uppermost part of the ancient cultural layers at a depth of about one meter (Fig. 020b, columns A.B) with a collapsed mud brick wall. The excavators thought the wall was not a fortification enclosing the entire settlement, but more likely the wall of a single building or yard.¹²⁹

In addition, the excavators attributed the Early Period of wood house construction to the Kayue culture. The construction of mud floor houses and a mud brick wall are synchronous to the spread of the Xindian culture.

Besides, the excavation of Fengtai provides the assumption that the period between 1500 and 900 cal BCE experienced slightly wetter conditions than at present, which is in agreement with the archaeological results.

2.1.7 Tongren county

The Tongren county lies in the Longwuhe Valley. Many sites of the Qijia and Kayue

¹²⁸ Xu X. G. et al. 2003, 88.

¹²⁹ Xu X. G. et al. 2003, 106.

cultures were identified in the surveys conducted in 1983 and 1987¹³⁰. One dagger axe and two knives (Fig. 008) were collected from one grave of the Zong'an temple in the Tongren county¹³¹. The excavators suggested that they were related to the Scythian bronzes. However, the two-eared potteries coexisting with these bronzes were very common in the Kayue culture.

2.1.8 Xunhua county: Suhusa cemetery

The Suhusa cemetery lies southeast of the Xunhua county and the south bank of the Yellow River. It was excavated twice, whereby 116 graves¹³² were discovered. Of them, 65 belonged to the Banshan culture, 1 to the Neolithic, 22 to the Kayue culture, and 28 are unclear.

The tombs of the Banshan culture are mainly distributed in the northern half part of the cemetery. Apart from an earth catacomb, others are built in earth shaft pits; 39 of them are furnished with wooden coffins. As for the burial manners, there were primary, secondary, and crematory burials; most of the dead were buried singularly and secondarily; by contrast, double-person or multi-person burials occurred rarely, only in three cases. Among the funeral objects, pottery vessels were the most commonly found.

The tombs of the Kayue culture lie principally in the southern half part of the cemetery. As for the type of tomb concerned, the earth shaft pit, mostly furnished with coffins of birch planks, is the dominating form. Three urn burials and one catacomb were found as well. The urn coffin was made of two jars, which were jointed mouth to mouth. Regarding the burial manners, the secondary burial with single disordered dead is the most popular. Among them, are two double-person burials; and a few single tombs, where the dead lie in an extended supine position. Besides, 16 bronze artifacts were found, including 15 bulbs, and one joined beads (Fig. 009).

The excavators temporarily assigned these 22 graves to the Kayue culture according to the pottery complex. The complicated elements shown in the Suhusa cemetery should be noted. Some bronze artifacts were also discovered at Ahatela¹³³ and Duojiangaga¹³⁴, but unfortunately, the information is not yet published.

2.1.9 Guide and Jianzha county: Shanjiaping cemetery

Over 190 sites belonging to the Neolithic and the Bronze Ages were found in the surveys of the Guinan and Tongde counties conducted in 1980, 1983 and 1987¹³⁵. One bronze bulb and bell were collected from the Chengxi village (Fig.010, 1-2).

¹³⁰ QHY 1990a, 36-47.

¹³¹ Gao D. L. 1985b, 48-49.

¹³² QHK 1994, 425-469.

¹³³ Xu/Ge 1981, 24-29.

¹³⁴ QHY 1991, 320.

¹³⁵ QHY 1990c, 16-23.

The Shanpingtai cemetery¹³⁶ lies west of the Guide county, which was excavated in 1981. A total of 90 burials were found, together with 629 funeral objects, including 2 bronze bells and 1 bronze knife (Fig. 011). According to the potteries and mortuary practice, the excavator assigned the Shanpingtai cemetery to the Kayue culture.

Thirteen sites of the Qijia culture, and 90 sites of the Kayue culture were identified in the survey of 1987 in the Jianzha county, and no remains of the Xindian culture were found¹³⁷. Some bronze artifacts ascribed to the Kayue culture were also found, including 1 ring, 1 arrowhead, some ornaments and tubes¹³⁸.

2.1.10 Datong county: Huangjiazhai cemetery

A total of six sites of the Majiayao type culture, six sites of the Qijia culture, and a few sites of the Kayue culture that resemble more with the Shangsunjiazhai type, and eight sites of the Han Dynasty were identified in the archaeological survey of 1986 in the Datong county¹³⁹.

In 1990, one dagger axe with a sheep on the guard and two axes (Fig. 012) were collected from the Liangjiao township in Datong county¹⁴⁰. The blades of all three bronze artifacts show evidence of being used. However, due to the lack of an archaeological context, it is difficult to tell whether they belonged to the Kayue culture.

Lying 27km north of Xining, the Huangjiazhai cemetery is an important Kayue culture site in the Datong county found together with 26 graves of the Bronze Age in 1985¹⁴¹. A total of 16 bronze artifacts were found, including 1 bronze bird ornament with a long beak and convex abdomen, 5 bells, 6 tubes, 2 bulbs, 1 spear and 1 scraper (Fig. 013). The excavators put forward that gender and social class differences were reflected in the burial manners. Bronze spears, bone daggers and bone arrowheads were always found in the male burials, implying that men were mainly engaged in war and hunting; however knives, awls, chisels and spinning whorls accompanied the female burials, showing that perhaps women undertook the daily productive labour. A total of 8 seashells were found, and 7 of them were in tomb M5. The excavators proposed that the seashells should be regarded as primitive money, proving that a small number of people owed more wealth than the majority of people at that time. Furthermore, the potteries found at the Huangjiazhai cemetery show the characteristics of the Qijia and of Kayue cultures, which seems more like a transitional type between the Qijia and Kayue cultures.

¹³⁶ QHWD et al. 1987, 255-273.

¹³⁷ QHY 1990d, 47-56.

¹³⁸ Figures are not yet published.

¹³⁹ QHY 1994a, 320-329.

¹⁴⁰ Liu/Chen 1990, 83.

¹⁴¹ QHY et al. 1994, 193-205.

2.1.11 Huangyuan county

The Huangyuan county, lying in the upper reaches of the Huangshui River, is one of the important Kayue culture counties.

2.1.11.1 Dahuazhongzhuang cemetery

The Dahuazhongzhuang cemetery was excavated in 1983, found together with 118 graves and over 1000 funeral objects, including about 425 bronze artifacts.¹⁴²

Without containers, these bronze artifacts consist of implements of production, daily wares, and ornaments, made by a mould pouring practice, including 6 spears, 1 arrowhead, 1 awl, 3 knives, 34 mirrors, 4 tubes, 2 sticks, 43 bells, 7 earrings, 5 rings, 204 bulbs (Fig. 014a), 65 plaques and 61 beads¹⁴³ as well as 2 pole tops. It is worth mentioning that one pole-top was discovered from tomb M87 in the form of a dog lying on the end of the long beak, of a long-necked bird head, barking against a cow with erected shoulders and upwards tail, standing on the bead-circled round eyes of the bird. It is interesting that one calf stands under the cow drinking milk (Fig. 014, 5). Certainly true to life, this artifact was skillfully constructed. Another one was also discovered but broken and incomplete in tomb M87.

Both the burial manners and funeral objects of the Dahuazhongzhuang cemetery have their own attributes, providing important new materials for research on the Kayue culture and its development. Firstly, the oval and triangular shaped tombs were bigger than the rectangular shaped ones and normally had a racking platform. Secondly, most of the dead had been dug out and disturbed after being buried for some time, then reburied into the original tomb. Quite a few of these tombs were disturbed at the same time so that the mix up of the skeletons was unavoidable, causing some of the dead to have less bones and others to have more. The ash and gravel in front of the tombs implies that one sacrifice ceremony was probably held after the secondary burial (Fig. 014b; Fig. 014c). This phenomenon is perhaps owing to the religious tradition at that time. Thirdly, ornaments made by bronze, stone, jade, bone, shell and so on were the main funeral objects. This custom still prevails nowadays in *Zang* (藏) people. We can also infer the flourish of animal husbandry at that time in light of the abundant bones of horse, sheep and bull buried in the tombs. Fourthly, there are 6 groups of 14 tombs with superimposing relations: M98→M90; M97→M95; M94, M93→M96; M107→M101; M104→M105, M106→M105; M103→M102, these relations provide important proof to date the relative chronology of the potteries. The excavators considered that if the Shangsunjiashai type belonged to the late Kayue culture, the Dahuazhongzhuang cemetery should be later than the Shangsunjiashai type.

¹⁴² QHHYB et al. 1985, 11-34.

¹⁴³ The figures are not yet published.

2.1.11.2 Mobula site

Although thousands of graves belonging to the Kayue culture have been found in the Qinghai Province, it was the first time in 1987 that 4 houses, together with 1 grave (M7) of the Kayue culture were discovered and formally excavated at Mobula¹⁴⁴ in the Huangyuan county.

Houses F1 and F2 were supported by wood pillars and neither the walls or roof were discovered. So it is thought that they were used as a kitchen or corral (Fig.015a). This kind of house, still exists today. Neither wood pillars nor traces of walls or roofs were found in F3 and F4 (Fig. 015b). Furthermore, the floor was slanted so that it helped to drain water, which resembles that of the present tent. Besides, more ashes than objects were discovered inside the house. It was proposed that the feces of bulls and sheep found were used as fuel, implying that the people in Mobula probably made a living from animal husbandry during the time of the Kayue culture. On the basis of the potteries and other objects (Fig.015c; Fig. 015d) found, the excavators assigned the Mobula site to the late Kayue culture, thus these 4 houses provided important information about the economic situation of the late Kayue culture.

2.1.11.3 Huabiliang and Luanshan

In total, 13 graves of the Kayue culture were excavated at Huabiliang in the Tawan township, and 5 graves were found at Luanshan in the Shenzhong township in 1982¹⁴⁵. Most of them were secondary burials. Some of them were buried with animal bones, especially those of horses, cattle, dogs, and sheep. Several bronze artifacts were found, including 1 spear, 1 knife, a few bulbs, bells and plaques (Fig. 016a). 1 bronze bird and 1 human figure were also collected (Fig. 016b).

Some of the potteries found in the tombs show great similarities to the Tangwang style pottery. On the other hand, they differ with the typical Tangwang style pottery. On observing the manufacturing technique of the potteries, the excavators attributed them to the late Kayue culture.

2.1.12 Huangzhong county: Panjialiang cemetery

The Huangzhong county lies in the middle branches of the Huangshui and south end of the Qilian Mountains. The Panjialiang cemetery is one of the important Bronze Age sites¹⁴⁶ in the Huangzhong county.

A total of 244 tombs of the Kayue culture (Fig 017a) were discovered at Panjialiang, together with over 7000 funeral objects in 1981 and 1982¹⁴⁷. Among them: 25 knives, 12 tubes, 2 arrowheads, 15 axes, 1 battle axe, and many ornaments including bells,

¹⁴⁴ Gao/Xu 1990, 1012-1011.

¹⁴⁵ QHWD 1986b, 882-886.

¹⁴⁶ HHWWZ 1991.

¹⁴⁷ QHY 1994b, 28-98.

bulbs, joined beads all of which were made by bronze (Fig.017b) were found. No evidence has proven that the bronze axes were used; accordingly, these axes were perhaps exclusively manufactured as funeral objects.

The mortuary practice of the Panjialiang cemetery is very characteristic. The deceased were first placed in an extended and supine position. After a certain period of time, most of tombs were consciously dug up and the bodies were dragged out of the tombs and torn into pieces, normally the head was smashed and broken. Then they were taken back to the tombs and buried again (Fig. 017f). The excavators considered that all of the 84 potteries (most of them are complete) found in front of the tombs (Fig. 017g) were used as articles of tribute for the secondary burials, which did not belong to certain tombs but the whole cemetery. These burial manners could be one of the religious ceremonies.

The quantity and variety of the funeral objects differ in gender and status. In addition, some of the dead were supposed to be buried alive as articles of tribute. They were laid down against the walls (Fig. 017c) or corners (Fig. 017d; Fig. 017e) of the tombs and seemed to be bound, and kneeling down towards the main dead, normally without being disturbed after the second conscious disturbing of the main dead (Fig. 017g). The excavators therefore concluded that they could have been the slaves of the main dead. In total, 32 cases of the dead were found buried alive in 26 of the 244 tombs.

Besides, 14 groups, namely 25 tombs with the superimposing relations were found (Fig. 017h; Fig.017i; Fig. 017j). Accordingly, the excavators divided most of the tombs into three periods based on the pottery complex¹⁴⁸. In addition, the human bones found from tomb M78 were dated to B. P. 2838±145.

Named after the Kayue village, the Kayue culture is one important bronze culture in the Qinghai and Gansu regions. The Panjialiang cemetery is situated only 1.5km north of the Kayue village. The potteries found in Panjialiang are almost the same as those found in the Kayue culture, nearly without any trace of elements from other cultures, as stated by the excavators.

Many other sites in the Huangzhong county, such as the Zhujiashai¹⁴⁹, Nancun cemetery, Zhaodongkou cemetery, Huanggaotai cemetery, Zhadongkou cemetery, Huangjiatai, Dongjiawan, Xiatai, Baiya, and Kayue village¹⁵⁰ were found with bronze artifacts as well (Fig. 018, 1-3). However, most of the related figures have not been published. One bronze axe and two mirrors were collected from the Qianyang village.

2.1.13 Other sites

The Guinan and Tongde counties are situated in the south bank of the upper Yellow

¹⁴⁸ QHY 1994b, 63.

¹⁴⁹ An Z. M. 1959a, 376.

¹⁵⁰ DTJQH 96.

River. In total, 73 sites of the Bronze Age were identified in the survey of 1982 and 1987¹⁵¹. A total of 49 pieces of bronze artifacts, including mirrors, hoops and bulbs (Fig. 019, 1-3) were found at Gamatai, Guinan county¹⁵². Some bronze hoops (Fig. 019, 4-6) and dagger axes were unearthed from the Zongri and Tongde counties¹⁵³. In 1957 and 1959, Dulan county was surveyed and excavated¹⁵⁴, found together with 9 adobe walls, 11 houses, 9 adobe pits and 3 urn burials. Some slag and 14 bronzes were collected as well, including 3 axes, 7 bronzes, 1 Yue and 3 arrowheads (Fig. 101d, 1-18).

Some other copper and bronze artifacts were found at Dalitaliha¹⁵⁵, Tawentaliha and Baishuihe¹⁵⁶ as well. It is worth mentioning that the big spear (Fig. 018, 4) found from Shenna¹⁵⁷ aroused great interest and argument amongst archaeologists¹⁵⁸.

2.2 Discoveries of bronzes in Ningxia

The Ningxia Hui Autonomous Region, one of the five autonomous regions of minority ethnic groups in China, situated in the eastern part of northwestern China is between 104.17° E and 107.38° E, and 35.14° N and 39.23° N. The Shanxi Province lies to its east, the Gansu Province lies to its south, and Inner Mongolia adjoins it in the north. The region covers 800 square km. Its topography is mainly composed of mountains and highlands. The whole region is 2000 meters above sea level, although generally the southern part is higher than the northern part. Rivers that flow through Ningxia include the Yellow River.

Ningxia is a relatively dry and desert-like region. The region is 1,200km from the sea and has a continental climate with average summer temperatures rising to between 17 and 24°C in July, and average winter temperatures dropping to between -7 and -10°C in January. Seasonal extreme temperatures can reach 39°C in the summer and -30°C in the winter. The average temperature variation in summer is 17°C. Annual rainfall averages from 190 to 700 millimeters, with more rain falling in the south of the Ningxia region.

A number of Bronze Age sites were identified and excavated in Ningxia. The related copper and bronze information will be introduced as follows.

¹⁵¹ Wang G. S. 1990, 17-44.

¹⁵² Shinian 91.

¹⁵³ QHW et al. 1998, 1-14. 35.

¹⁵⁴ QHW et al. 1963, 17-43.

¹⁵⁵ QHW et al. 1963, 17-43.

¹⁵⁶ DTJQH 1996.

¹⁵⁷ Nianjian 93.

¹⁵⁸ It will be discussed later.

2.2.1 Zhongwei county: Langwozikeng

The Zhongwei county borders the Ordos Plateau along its northeast and the Hexi Corridor along its northwest. In 1987, a total of 11 burials were unearthed at Langwozikeng, Zhongwei county¹⁵⁹ found together with about 400 bronzes, including short swords, daggers, knives, axes, awls plaques, figures and horse and chariot fittings (Fig. 021).

As stated by the excavators, the short swords (Fig 021, 11-14), crane hook (Fig. 021, 17), axes (Fig. 021, 22-25), chisel (Fig. 021, 26), and buckles (Fig. 021, 37-38) show great similarities to those found from the Taohongbala¹⁶⁰ and the Hulusitai cemeteries¹⁶¹. While the turbine shaped plaque (Fig. 021, 36), the spade shaped plaque (Fig. 021, 39), horse figure (Fig. 021, 42) and bell resembled those found from Yushugou in the Yongdeng county¹⁶².

In addition to the absence of iron knives and gold earrings, when compared to the Taohongbala Cemetery, the bronzes found at Langwozikeng are much simpler in form and manufacturing technique. The Taohongbala Cemetery was generally dated to the late Spring and Autumn period, so the iron sword with a bronze handle found in Langwozikeng (Fig. 021, 10) is dated to the early Spring and Autumn period. Furthermore, the bronze sword, crane hook, arrowhead, and dragon-patterned plaque possess the typical traits that dominated the Western Zhou period. Accordingly, the whole cemetery was later than the Spring and Autumn period.

2.2.2 Pengyang county

The Guyuan region lies in the south of Ningxia, bordered by the northern nomadic zone and the central agricultural region, synchronously impacted by the Ordos bronzes and the Central Plain. The Pengyang county is situated inside the Guyuan region. Quite a number of bronzes were found there.

Since 1974 a large quantity of bronzes have been discovered or collected from different sites in the Pengyang county¹⁶³, including the Zhangjie village in the Caomiao township (Fig. 022a; Fig. 022b), Baiyanglin village in the Xinji township¹⁶⁴(Fig. 029, 4.19.22), Miyuan village in the Liuyuan township (Fig. 023; Fig. 029, 5), the Xianma village (Fig. 024) and Guantai village (Fig. 025) in the Jiaocha township, the Baicaowa village in the Goukou township (Fig. 026), the Baicha village in the Yaoxian township (Fig. 027), the Dianwa village in the Gucheng township (Fig. 028), and the Mengyuan village and so on (Fig. 029).¹⁶⁵

¹⁵⁹ Zhou X. H. 1989, 971-980.

¹⁶⁰ Tian G. J. 1976, 131-141.

¹⁶¹ Ta L. etc. 1988, 11-18.

¹⁶² GSBG 1981a, 34-36.

¹⁶³ Yang/Qi 1999, 28-37; NXY et al. 2002, 14-24.

¹⁶⁴ Luo/Yan 1993, 17-21

¹⁶⁵ Luo/Han 1990, 403-418.

The Zhangjie Cemetery lies to the north of the Zhangjie village, Caomiao township, Pengyang county. It was officially excavated again in 1998.¹⁶⁶ The work resulted in the revelation of 6 tombs and 1 burial pit, which yielded 72 animal victims and 84 pieces of grave goods, including 72 bronzes and pottery vessels, iron wares, bone and stone artifacts. The tombs were put into earth caves with shaft passages and earth shafts. Only tombs M2 and M3 were well preserved (Fig. 022b, A.20,B.18.). The bronzes largely consisted of swords, knives, chisels, tubular ornaments, plaques, buckles, and button-shaped ornaments (Fig. 022b). The cemetery was assigned by the excavators to a burial ground of the Western Rong (西戎) ethnic group, from the late Spring and Autumn period to the early Warring States period.

The other bronze sites found in the Pengyang county resemble them in not only burial manners but also grave goods. Most of the bronzes were unearthed from the graves. The earth pit graves were very common. Some of the graves included animal victims, such as cattle, sheep and horses. Normally the deceased were placed in an extended and supine position. The burial manners show typical traits of the northern people. Most of the bronzes can be dated between the late Spring and Autumn period and the late Warring States.

2.2.3 Xiji county

The Xijie county also lies inside the Guyuan region, south of Ningxia. During 1985-1991, a total 7 of burials were found together with bronzes at the Chenyangchuan village, Xinying township¹⁶⁷ (Fig. 030). Some bronzes were collected from the Baiya township and Xinglong township as well(Fig. 031).¹⁶⁸ Unfortunately, only a few of the materials have been officially published. The excavation in 1988 conducted at the Chenyangchuan village yielded a total of 62 bronzes (Fig. 030, 1-16) and 15 sets of animal victims. It is worth mentioning that two iron swords (Fig. 030, 21) were found, thus the excavators ascribed it to the late Warring States period.

2.2.4 Longde county

The Longde county lies south of Ningxia. In the middle of the 1980s, some graves of the early and middle Warring States period were discovered in the Longde county¹⁶⁹. The tombs at the Wugou village in the Wenbao township, Jizhuanchan in the Shatang township, and in the Heshenlin township were partly or heavily disturbed and destroyed. The accompanying bronzes (Fig. 032) and animal victims show great characteristics of the Northern Bronzes, which were attributed to the Xiongnu people by the excavators.

¹⁶⁶ NXY et al 2002, 14-24.

¹⁶⁷ Luo F. 1993, 31; Yan/Li 1992, 573-575; Luo/Han 1990, 403-418.

¹⁶⁸ Luo/Han 1990, 403-418.

¹⁶⁹ Wang J. Q. 1990, 5-7; Luo/Han 1990, 404.

2.2.5 Zhongning county: Niding

The Zhongning county is bordered by the Tenggel Desert. One group of bronzes were discovered from the Niding village¹⁷⁰. These bronzes contained a short sword, knife, arrowhead, mirror, awl, axe, buckle, and many horse and chariot fittings, such as horse bit, gag bit, Danglu, Dun and tubular ornaments (Fig. 033).

Though one grave was partly destroyed, the excavators attributed these two graves to the same culture based on the grave goods assemblage. The antenna-headed short sword was quite common in the Spring and Autumn period, however it was largely replaced by loop-headed short swords in the Warring States period. One bronze sword found at Niding has an antenna head and the other three have loop heads (Fig. 033, 1-4). Besides, the motifs on the mirror (Fig. 033, 20) show great differences to those from the Central Plain, not only in content, but also in their varying pattern. Consequently, the two graves were dated by the excavators to the early Warring States period.

Besides, most of the grave goods are constituted of horse fittings and weapons. With the exception of the geometrical designs, tigers and hawks were the favorite designs, implying the nomadic life of the deceased. Bronze short swords, crane hacks, socket axes and various kinds of ornaments are the main characteristics of the northern bronze cultures. The ethnic ascription of these two graves is still in argument.

2.2.6 Guyuan county

The Guyuan county lies south of Ningxia. Quite a lot of Bronze Age sites have been identified and found in the Guyuan county.

2.2.6.1 Mazhuang

From September to November in 1989, a total of 49 tombs of the Eastern Zhou period near the Mazhuang village in the Yanglang township were excavated with 891 various objects and 2011 beads¹⁷¹.

Twenty tombs were heavily destroyed and the other 29 tombs displayed rather strong local and ethnic features. The catacomb was popular and the deceased was placed with the head lower than the feet (Fig. 041a). Normally the deceased were buried singularly in an extended and supine position. No joint burials as well as coffins have been found. Both the inside of the caves and passages were scattered with sacrificial animals, such as cattle, horses, and sheep.

The funeral inventory includes objects made of gold, silver, bronze, iron, bone, horn, stone, agate, turquoise and so on. Of them, the bronzes are the largest in quantity and bone wares and iron wares come next. Bronzes, chariot trappings and clothing

¹⁷⁰ Zhong K. 1987a, 773-777.

¹⁷¹ NXY et al. 1993, 13-56.

ornaments with local features were the most common, though a few articles show similarities to their counterparts in the Central Plain. All objects were originally made for daily use (Fig. 041b).

According to the stratigraphical evidence and assemblage of funeral goods, the tombs can be divided into an earlier phase and a later phase: the former corresponds to the time from the end of the Spring and Autumn period to the early Warring States period; the latter, to the late Warring States period. All the graves were probably remains of the same ethnic group.

In light of written records and previous studies, it can be inferred that the Mazhuang cemetery belonged to the Rong tribes, as stated by the excavators. Its discovery provides new knowledge regarding the content of the Northern Bronzes cultural system and its creators. Zhong Kan and Han Kongle¹⁷² pointed out that the bronze cultures in south Ningxia were well developed in the middle Spring and Autumn period, forming special local traits, though influenced partly by the Qin culture from the east. The excavators ascribed these bronze cultures in south Ningxia to the Xiongnu People.

2.2.6.2 Others

In 1973, one group of bronzes were accidentally found at the Xijiao Commune¹⁷³, including pickaxes, adzes and ornaments, which were considered to have belonged to the Xiongnu People (Fig. 034), dated to the Warring States. In addition, 3 silver objects were also found.

More graves were found with a considerable number of bronzes, including Yangwa in the Hechuan township (Fig. 035), Dabeishan in the Yanglang commune (Fig. 036) Wangjiaping in the Touying commune¹⁷⁴ (Fig. 037) and Lüjiaping village in the Hechuan township¹⁷⁵(Fig. 038). There are also some stray finds(Fig. 039). These graves are similar not only in mortuary practice but also in the bronze objects. Firstly, the animal victim was very common, as the 20 horse skulls found at Dabeishan and 14 at Yangwa demonstrate. Secondly, apart from a small quantity of spears and daggers, the bronzes consisted mainly of horse and chariot fittings and ornaments. Moreover, animal motifs, such as deer, tigers, donkeys, horses and the head of hawk dominate as well as some geometrical designs. All of them fully reflect the natural environment, animal husbandry, and hunting life at that time. Zhong Kan and Han Kongle date the Dabeishan cemetery in the Yanglang Commune and the Yangwa cemetery in the Hechuan Commune to the Late Spring and Autumn period and date the Wangjiaping village in the Touying Commune to the late Warring States on the basis of comparing

¹⁷² Zhong/Han 1985, 211-212.

¹⁷³ Zhong K. 1978, 86-90.

¹⁷⁴ Zhong/Han 1985, 203-213.

¹⁷⁵ GYB 1992, 469-470.

the bronzes to those found at the Taohongbala Cemetery in Inner Mongolia. As for the collected bronzes concerned, they are also dated to between the Spring and Autumn and the Warring States period¹⁷⁶.

Besides, quite a considerable quantity of bronzes were found at the Samen village and Houmo village in the Pengbao township as well as in the Hechuan township and Nanjiao township and so on¹⁷⁷ (Fig. 040). It is notable that the cowrie and cuniform gold found in the Houmo village, were probably used as a primitive kind of money at that time.

It was the first time in 1981 that one pit with horse and chariot fittings and one tomb ascribed to the Central Plain style were found in Sunjiazhuang¹⁷⁸. This pit lies 7.5km northeast of the Guyuan county and 2km south of the Qin Great Wall. There were two sets of horse skeletons. The typical Central Plain style bronze wares such as vessel-Gui and Ding were also found in this tomb (Fig. 042). In addition, the excavators dated them to the Western Zhou period. Whether this tomb belonged to the northern people or the Zhou people is still in dispute.

2.3 Discoveries of Bronzes in the Gansu Province

The Gansu Province is situated at the geographical center of China, lying on the upper reaches of the Yellow River, and is a vast area. The Gansu Province is located between 32°11' - 42°57' N and 92°13' - 108°46' E. It meets Shanxi in the east, near Sichuan in the south, joins Qinghai and Xinjiang in the west, leans on Inner Mongolia and Ningxia, and borders Mongolia in the north. The total land area of the Gansu Province is 425,800 square km and ranks seventh place in China. The Gansu Province is a mountainous province and the major mountains are Qilianshan, Wushaoling, Liupanshan, Aerjinshan, Mazongshan, Helishan, Longshoushan, Xiqinshan and Ziulin and so forth. Most of them orientate from northwest to southeast. The forest resources are centralized in these mountainous areas, and most rivers form their main streams from these mountains. The landforms are complicated, the mountainous regions, plateaus, plains, river valleys, deserts and the Gobi are in staggered distribution. The topography shapes long and narrow areas with a length of 1,655km from east to west and a width of 530km from north to south, which can be divided into 6 large regions with different features: the Longnan region, Longzhong loess plateau, Gannan plateau, Hexi corridor, Qilianshan area, and north area of the Hexi corridor.

At the intersection of the three plateaus: the Loess Plateau, Qinghai-Tibetan Plateau and Mongolian Plateau, the climate of the Gansu Province is dry, the daily difference

¹⁷⁶ Zhong/Han 1985, 209.

¹⁷⁷ Luo/Han 1990, 403-418.

¹⁷⁸ GYG 1983, 982-984.

in air temperature is large, the sunlight is sufficient, and sun radiation is strong. The annual average air temperature is between 0-14 °C and reduces from the southeast to the northwest; the annual average air temperature in the Hexi Corridor is 4-9°C and the annual average precipitation is about 300mm. The precipitation varies greatly from 42 to 760mm and reduces from the southeast to the northwest.¹⁷⁹

Situated along the Silk Road, Gansu was an important province economically and a cultural transmission path as well. The related archaeological bronze information will be provided as follows.

2.3.1 Dongxiang county: Linjia

The Dongxiangzuo Autonomous county lies in the middle of the Gansu Province and borders the Linxia county to the west. The Linjia site is situated on the east bank of the Daxiahe. It was excavated in 1977, found together with 27 houses, 3 kilns and 98 pits of the Majiayao period, as well as 3 houses and 1 burial of the Qijia culture. Over 3000 pieces of artifacts belonging to the Majiayao period were discovered, including stones, bones, potteries, and bronzes¹⁸⁰.

It is worth noting that the earliest metal artifact-one bronze knife (Fig. 043b, 1) was found near the north wall of House F20 in Square T42 (Fig. 043a), which was attributed to the Majiayao period by the excavators. The Archaeometallurgy Laboratory of Beijing University of Iron and Steel Technology made an assay, showing that it consists of copper and tin. From the metallographic observation (Fig. 043b, 2), α solid solution dendritic crystals and a small amount of $\alpha+\beta$ eutectoid structure are visible on the blade and handle of the knife. The estimated tin content of the artifact is between 6% -10%. α dendrites are arranged along the blade, 1-2mm in width. We can also observe that this bronze knife was probably cast by two molds, one is a curved shape; the other is flat¹⁸¹.

Slag was discovered from H54 (trash pit), also dated to the Majiayao period. A petrology test indicated that the small slag pieces were constituted from malachite, and the large pieces contained 30% malachite, 40% limonite, 10% quartz, 5% hematite, 5% copper and a bit of olivine. Metallic copper is distributed irregularly in the central part of the slag, malachite is found in the outer shell and between cracks; and the quartz looks like a globular pellet. All of these indicators suggest that the slag comes from the remains of incomplete smelting copper-iron ore. Two pieces of such slag were also discovered in the 4th stratum of Square T57.

Apart from the evidence of the slag, the Gansu Province is provided with abundant copper ore, including cassiterite and jewellers putty, implying from another viewpoint

¹⁷⁹ After <http://preview.english.mofcom.gov.cn/aarticle/subject/business/lanmub/200704/20070404618945.html>.

¹⁸⁰ GSG et al. 1984, 111-116.

¹⁸¹ GSG et al. 1984, 116; Sun/Han 1997, 38.





that the bronze knife may have been accidentally made by the local people instead of being consciously produced, or introduced from the outside.

There are three radiocarbon dates. The two dates from H19 and F21 are much closer, nearly 4700 B.P.(ca.). The third one from F20 is dated to 5200 B.P. (ca), almost 300 years earlier than the other two. While houses F20 and F21 are both in the upper layer (the later period), therefore both of them should stay in the same period, namely the date from F20 is probably not advisable. Consequently, both F20 and H54 at Linjia belonged to the late Majiayao culture remains, which can be dated to 2740 BCE (after tree-ring correction), or equivalent to the late Yangshao culture in the Central Plain.

Unfortunately, the earlier dates of the Linjia site have not been appraised. In the excavators' opinion, the earlier Linjia site is parallel to the Caojiazui site in Lanzhou and the Jiangjiaping site in the Yongdeng county¹⁸². The knife (75.X.D.T473) found at Jiangjiaping was determined to be a tin-bronze product. A Machang copper block and awl were found at Gaomuxudi and Zhaotitan in Jiuquan county respectively. The former is a cast copper, and the latter was shaped by hot forging. The date of the Machang culture ranges from 2300 to 2000 BCE.¹⁸³

2.3.2 Minle county: Donghuishan

The Minle county lies at the foot of the Qilianshan and the middle of the Hexi Corridor. Situated northwest of the Minle county, the Donghuishan site was surveyed and excavated in 1987 and 1988¹⁸⁴. A total of 249 Siba culture tombs were discovered, found together with 15 bronzes and 1 gold earring (Fig. 044a). Among them, 15 pieces were appraised (Table 4)¹⁸⁵.

Lab No.	Original No.	Variety	Situation of rust	Assay item
1650	T7③:4	Earring 	Surface is covered with green rust	①③
1651	M21:1	Earring 	Surface is covered with green rust	①③
1652	M205:3	Knife 	Surface and interior are entirely corroded	②
1653	M127:12	Knife 	Surface is covered with green rust	①③
1654	M4:2	Knife	Surface and interior are entirely corroded	②

¹⁸² GSG et al 1984, 159.

¹⁸³ Xia N. 1977, 217-232.

¹⁸⁴ Donghuishan 98.

¹⁸⁵ Donghuishan 98, 191-195.








1655	0155	Knife 	Surface and interior are entirely corroded	②
1666	M218:2	Knifepoint 	Surface is covered with green rust	①③
1667	M78:3	Knife	Surface and interior are entirely corroded	②
1668	M51:1	Earring 	Surface is covered with green rust	①③
1669	T12②:3	Earring 	Surface is covered with green rust	①③
1670	M79:1	Earring 	Surface is covered with green rust	①③
1671	M26:10	Awl 	Surface is covered with heavy green rust	③
1672	M23:6	Loop 	Both surfaces are covered with green rust	②③
1673	M36	Knifepoint	Heavy rust	③
1674	M34	Earring	Surface is covered with green rust	①③

Table 4. Basic information on the 15 bronzes found at Donghuishan, Minle county, Gansu Province. Remark: ① Atomic absorption spectrometry by the center laboratory of the University of Science and Technology Beijing. ② Scanning electron microscope by the Material Department of the University of Science and Technology Beijing. ③ Metallographic structure analysis by the Archaeometallurgy Laboratory of the University of Science and Technology Beijing.

Lab No.	Element (weight %)					
	Cu	Sn	Pb	Fe	As	Total
1650	93.2	0.5	0.1	<0.005	4.9	99.0
1651	94.1	<0.05	<0.005	<0.005	2.9	97.5
1653	92.4	<0.05	<0.005	0.02	3.9	96.4
1666	91.9	0.7	0.04	0.057	5.1	97.9
1668	93.1	1.7	0.2	0.038	4.6	99.8
1669	93.8	0.4	0.4	0.007	5.1	99.9
1670	94.3	0.1	0.02	0.005	5.4	99.9
1674	88.2	7.9	0.1	0.01	2.6	98.9

Table 5. Results of the Atomic Absorption spectrometry on the Bronzes of the Siba culture found at Donghuishan in Minle, Gansu (adapted from Donghuishan 98, 192 Table 2).

Sample 1672 and 4 knives (1652, 1654, 1655, and 1667) were observed by Energy Dispersive X-ray Analysis. A secondary electron image of 1672 shows that many white granules are distributed in solid solution grains that contains 95.5% copper, 2.1% arsenic, and 1.4% tin. The white granules are lead (Fig. 044b, 1). The four knives are heavily corroded. Their secondary electron image shows that there are laps between three layers of rust. Meanwhile the Energy Dispersive X-ray Analysis shows that the four knives are made of Cu-As alloy.

In addition, 11 pieces of samples have been appraised by metallographic structure identification. Many grey-blue copper and iron sulphide granules are distributed in the surface; all samples exhibit a forging structure, solid solution re-crystallized grains, and compound twins after etching. Some hot forged samples have signs of further cold working (Table 6; Fig. 044b, 3-5; Fig. 044c).

Sample	Metallographic structure
1650 earring	The microstructure consists of solid solution re-crystallized grains and twinned structure with numerous black porosity and grey-blue sulphide.
1651 earring	Solid solution re-crystallized grains and twins are relatively bigger than the numerous black holes that are distributed along the grain boundaries.
1653 knife	As the same as 1650
1666 knifepoint	Solid solution re-crystallized grains extend along the processing direction as well as the grey-blue sulphide.
1668 earring	Solid solution re-crystallized grains are a little deformed with slip lines, and deformed sulphide inclusions are distributed along the boundary of grains.
1669 earring	Solid solution re-crystallized grains distort slightly with slip lines. It consists of numerous black porosity and grey-blue sulphide inclusions.
1670 earring	The microstructure consists of solid solution re-crystallized grains, twinned structure, porosity, and grey-blue sulphide inclusions. Some parts of the borders distort.
1671 awl	The microstructure consists of solid solution re-crystallized grains and slip lines. In the boundaries are distributed black porosity and sulphide inclusions.
1672 loop	The microstructure consists of solid solution and twinned structure.
1673 knifepoint	The sample is corroded. Solid solution re-crystallized grains are elongated after etching.

1674 earring	The microstructure consists of solid solution re-crystallized grains and twinned structure. In the boundaries, many sulphide inclusions and porosity are distributed.
--------------	---

Table 6. Metallographic structure of the bronzes from the Dongshuishan, Minle county, Gansu Province (adapted from Donghuishan 98, 193 Table 3).

All of the results are concluded as follows:

1) The forms of the 15 artifacts are very simple. There are twelve arsenical coppers containing 2-6% arsenic. According to the results of the atomic absorption spectrometry, three artifacts are shaped by hot forging, containing 1.4%, 1.7% and 8% tin respectively.

2) 11 artifacts show a forged structure by metallographic identification. In the process of hot forging, the solid solution takes shape into the deformed re-crystallized grains and slipperly. Six hot forged artifacts have signs of further cold working. Forging techniques and the content of arsenic are typical traits in the early period of the Siba culture alloys.

The slag found from the mining site of Dajing in Linxi county that was dated to the Spring and Autumn period¹⁸⁶ contain 3.4-6.0% arsenic, with an average of 4.5%. It is remarkable that the average amount of arsenic contained in the bronzes from the Donghuishan site is 4.3%. In addition, the Qilianshan is provided with nonferrous metal ore. Therefore, it is possible that the ancient people used condurrites such as panabase and arsenopyrite at that time.

As we know, in the fourth millennia BCE, arsenic-copper artifacts were very common in West Asia, south Europe, and North Africa, so the evidence of arsenic-copper in Donghuishan provides some more evidence in understanding the connections between the east and the west.

The Huoshaogou cemetery in Yumen was excavated in the middle of the 1970s, found together with over 300 tombs and 200 bronzes¹⁸⁷. There are four radiocarbon dates from the Huoshaogou Cemetery: 3250±100 B. P., 3300±85 B. P., 3490±100 B. P., 3350±100 B. P. (see Appendix). So far, only two radiocarbon dates of the Donghuishan site¹⁸⁸ are available: 3490±100 B. P. and 4230±250 B. P. (Appendix) The former is very close to the radiocarbon dates from the Huoshaogou Cemetery.

2.3.3 Wuwei county: Huangniangniangtai

The Wuwei county is situated in the central part of the Gansu province, on the east end of the Hexi Corridor. The Huangniangniangtai site has been excavated three times

¹⁸⁶ Li/Han 1990, 151-160.

¹⁸⁷ GSB 1979, 139-151.

¹⁸⁸ One charcoal sample is collected from Square TG②; another sample is carbonized wheat.

from August 1957 to 1959¹⁸⁹, which opened up a total area of 750 square meters, including 5 dwellings in the form of a square with a plastered floor, 42 ash pits and 24 tombs, found together with 23 pieces of copper and bronzes (Fig. 045a, 1-11).

The deposits of the site were relatively well preserved. The discovery of copper implements and oracle bones in the remains of the Qijia culture is a matter of great interest. Most of the oracle bones uncovered come from pig and cattle. Moreover, their preparation is also of a rather primitive nature in comparison to that of the Yin oracle bones unearthed at Anyang¹⁹⁰. The copper implements found at this site consisted only of a few small items such as the knives and awls, showing that the use of metal was still in its infancy. The excavators are, therefore, of the opinion that the Qijia culture or at least its later stage already belonged to the Chalcolithic period. The finds also indicate that there already existed well-established burial customs at that time. For instance, flexed burials appear to have been very common in the early stage of the Qijia culture, while on the other hand, extended burials are usually found in tombs with a neatly shaped rectangular pit. Sometimes the latter may also be found in the deposits of the later stage or else superimposed on the flexed burials. The absence of any tomb furniture in the early stage as well as its increasing presence in the latter tombs is testament to the increased productivity towards the end of the Qijia culture.

The fourth excavation at the Huangniangniangtai site in 1975¹⁹¹ yielded a total of 62 graves, 4 house remains and 23 pits of the Qijia culture (Fig. 045b), found together with stone implements, bone objects, copper tools, ornaments and oracle bones. The bulk of the implements are made of stone. It is worth noting that the hoes, adzes, and chisels are in fact made of jade or some jade-like stones, which are largely hand-made and decorated with either a basket or cord design.

Seven pieces of copper artifacts were discovered in tombs, including 2 knives, 3 awls and 2 drills (Fig. 045a, 12-15). In addition, the painted pottery was rather small and their decorations were dominated by rhomboid zigzags. The large number of animal remains consisted of pigs, goats, cattle, horses, chickens, and deer.

The tombs contain either one single burial, a joint burial or a triple burial. There were 12 joint burials. Except for one tomb with an adult and a child, the others consisted of one man and one woman. The man is buried in an extended position at the middle of the tomb facing upwards, while the woman lies in a flexed position on her side, mainly facing towards the man (Fig. 045c). It could be inferred that the men might have had a higher social status than the women at that time.

Out of the total number of single tombs, 52 were found to contain tomb furniture, which ranges in number from an average of about ten pieces to as many as well over

¹⁸⁹ GSB 1960c, 57-71.

¹⁹⁰ GSB 1960c, 71.

¹⁹¹ GSB 1978, 421-447.

ninety pieces. Besides, the dead were sometimes interred in a very haphazard manner. One house remain was also found, it was probably used by a single family because not only were many kinds of potteries found in the house but also a number of stone and bone implements (Fig. 045d). As suggested by the excavators, the Huangniangniangtai site is a pure and classical Qijia culture site. In addition, one part of the bronzes found from the Huangniangniangtai site has been examined¹⁹² (Table 7). Most of them are identified as copper.

Sample No.	Material and identification method	Manufacturing technique and identification method
H9 (3)	Copper (A)	Mold (observation)
T13:1	Copper (C)	
AT5:249	Copper (C)	
T18(2)		Coined copper (observation)
collected		Single mold (observation)
F3		Hammer (observation)
T6:3		Hammer (observation)
T10:3		Hammer (observation)
BT2(2)		Hammer (observation)
H9(3)		Hammer (observation)
T19(2)		Hammer (observation)
19948	Copper (D)	
2281	Copper (D)	
267	Copper (A)	
19946 75.W. X. T17	Copper (A. B)	Forge (metallographic examination)
19947 75.W. X.T18③	Copper (A. B)	Forge (metallographic examination)
19968(long) 75.W.X. T5	Copper (D)	Forge (metallographic examination)
19968(short) 75.W.X. T5	Copper (D)	
75.W.X.T17②	Copper (A)	
19951 75.W.X.T14③	Copper (B)	
19950 75.W.X.collected	Copper (A. B)	

Table 7. Results on the identification of the bronzes from Huangniangniangtai. (A) isotope portable X-ray fluorescence analysis; (B) quantitative atomic emission spectrometry analysis; (C) semi-quantitative spectrometric analysis by the Geology

¹⁹² Sun/Han 1997, 79.

Bureau of Gansu; (D) Atomic Absorption Spectrometry. Sample 19948 is now identified as copper instead of bronze (adapted from Sun/Han 1997, 79 Table 1).

2.3.4 Yongchang county

The Yongchang county lies in the middle of the Gansu Province, to the east of the Hexi Corridor and at the foot of the north Qilianshan.

2.3.4.1 Sanjiaocheng and Hamadun

In the survey of 1979 at Yongchang county¹⁹³, one city wall and four houses were found at Sanjiaocheng. Twenty-two tombs were found at Hamadun, which lies west of Sanjiaocheng (Fig. 046c) as well as a few bronze artifacts (Fig. 046a; Fig. 047b). The excavators attributed both sites to the Shajing culture¹⁹⁴ in light of one accompanying cylindrical pottery cups which show typical characteristics of the Shajing culture although the bronze artifacts exhibit the northern style.

The dwelling remains found from Sanjiaocheng may well have been a settlement for the nomadic people at that time because only an oven was found, no pillar hole was discovered and the boundaries of the house are unclear, implying that it may have been used as a tent. In total, 12 tombs were in the form of a one sided shaft pit. Most of the deceased were laid in an extended and supine position, and animal victims were very common (Fig. 046d). Till now, seven radiocarbon dates: 2530±90 B. P., 2650±95 B. P., 2600±125 B. P., 2500±90 B. P., 2870±160 B. P., 2770±90 B. P., and 2600±100 B. P., resulted from the charcoal samples taken from Sanjiaocheng (Appendix). All of them are in the time span of the early Spring and Autumn period¹⁹⁵.

2.3.4.2 Xigang and Chaiwangang

Xigang lies 310 meters east of Sanjiaocheng, and Chaiwangang is situated about 800 meters east of Sanjiaocheng. After the excavation at Sanjiaocheng and Hamadun during 1976 and 1979, Xigang and Chaiwangang were excavated from 1979 to 1981¹⁹⁶.

A total of 452 tombs at Xigang and 113 tombs at Chaiwangang were excavated, found together with about 2000 items of funeral goods, including potteries, bronze objects, iron and gold objects, stone wares, bone wares, leather, and textiles. In addition, the bronze objects were the most common funeral goods found (Fig. 065f; Fig. 065g; Fig. 065h; Fig. 098d; Fig. 098e; Fig. 098f), including swords, knives, beads, loops, plaques, buckles, bulbs, bells, tubes, mirrors and other ornaments. As stated by the excavators, all of the bronze objects show great similarity to the Ordos bronzes, however they differ in types and quantity. Among them, small personal ornaments

¹⁹³ GSBG et al. 1984, 598-601; GSY 1990, 205-236.

¹⁹⁴ In 1924, some bronzes were found from Shajing in Minqin county, Gansu Province. Therefore, Andersson put forward the title of Shajiang culture.

¹⁹⁵ ZSKKY 1981, 366.

¹⁹⁶ Xigangchaiwangang 2001.

were larger in quantity than weapons and implements. For example, personal ornaments such as various plaques, buckles, and beads were the chief components. While the Ordos bronzes (Fig. 098a, A 1; 2) were only unearthed in two cases from 565 tombs.

All of the tombs at Xigang and Chaiwangang were built in earth pit, which consisted of three forms: lateral-shaft pit (Fig. 065a; Fig. 065b; Fig. 065c; Fig. 098a; Fig. 098b), vertical shaft pit (Fig. 065d; Fig. 098c, A.B.C), and double-shaft pit (Fig. 065e; Fig. 098c, D). The lateral-shaft pit is the dominating form among them, with 281 tombs at Xigang and 45 tombs at Chaiwangang in quantity. Normally some logs, which were covered by mats or dry grasses, leaned against the lateral pit, where the deceased were buried (Fig. 065a, A.B.C). In addition, most of the vertical shaft pits were one meter in depth, with subsoil platforms on both sides, on which was sometimes blocked with some logs similar to a coffin cover (Fig. 065b, A). Dozens of tombs were built in double-shaft pits. Normally the deeper pit had a subsoil platform (Fig. 065e, A; B).

The mortuary practice of the Xigang and Chaiwangang cemeteries are quite coincidental. The body of the deceased, sometimes wrapped up in grass mats, textile or leather, was usually laid in an extended supine position on the grass mats; some were laid in a flexed side position. Besides, animal sacrifices of sheep, horses, and cattle and even human beings were also found in some tombs, indicating that polarization of the rich and poor may have existed at that time. The excavators ascribe these two cemeteries to the Shajing culture.

2.3.2 Linxia Hui Autonomous Prefecture and Yongjing county

The Linxia Hui Autonomous Prefecture and Yongjing county lie in the west of the Gansu Province. Some Bronze Age sites were once administratively attributed to the Yongjing county, and later to the Linxia Hui Autonomous Prefecture. All of the sites found from both counties will be discussed together.

2.3.2.1 Lianhuatai

The Lianhuatai village¹⁹⁷ lies in the north of Linxia county, which is separated by the Daxiahe into two parts: Wazhazui and Heitouzui. A total area of 889.5 square meters was unearthed in 1959¹⁹⁸. The excavators thought that the characteristics of Wazhazui resembled the Zhajiazui type of the Xindian culture¹⁹⁹, however the characteristics of Heitouzui is similar to the Jijiachuan type of the Xindian culture, according to the differences shown in the potteries. Altogether 9 pieces of bronze artifacts were found

¹⁹⁷ Lianhuatai once belonged to the Yongjing county, now it belongs to the Linxia county.

¹⁹⁸ Xie R. J. 1980a, 296-310.

¹⁹⁹ Xindian culture is one Bronze Age culture in the Gansu and Qinghai regions. Zhangjiazui and Jijiachuan represent two subtypes of the Xindian culture, which will be discussed later.

from both sites in the Lianhuatai village, including 3 knives, 2 awls, 3 buckles and 1 dagger (Fig. 047, 1-6). Among them, the dagger and one awl were identified as bronze, containing 81.2% and 81.7% copper (Table 8).

(%)	Cu	Sn	Pb	Zn	Fe	Others
KGI H119:1 awl	81.2	9.5	3.3	1.3		4.6
KGI H193:2 dagger	81.7	12.6		0.36	0.76	4.5

Table 8. Compositional analysis on the samples from Wajiazhui and Heitouzui (adapted from Xie R. J. 1980a, 304; 308).

The Lianhuatai site was excavated again in 1984²⁰⁰, found together with 18 burials as well as 16 bronze artifacts including 2 buckles, and 14 tubes (Fig. 047, 7-11). The excavators divided the 18 tombs into three periods, according to the potteries from tomb M10 and M11, the former overlying the latter (Fig. 047b). The Lianhuatai site provides critical information on the Xindian culture.

2.3.2.2 Zhangjiazui and Jijiachuan

The Zhangjiazui and Jijiachuan sites²⁰¹, located in the southern part of the Yongjing county and excavated in 1959²⁰² and 1960²⁰³, contain both remains from the Qijia and Xindian cultures, providing stratigraphical evidence that the Xindian culture is later than the Qijia culture. The cultural relics of the Xindian type found at Zhangjiazui constitute a new type of culture that embraces both the pottery of Tangwang-style pottery²⁰⁴ and the remains of group B of the Xindian culture. In order to differentiate this one site from the other, the excavators designated one site to the Zhangjiazui type and the other to the Jijiachuan type.

A total area of 995 square meters was excavated at Zhangjiazui, bringing to light 13 storage-pits from the Qijia culture, 165 storage-pits from the Xindian culture as well as artifacts of stone, bone, pottery, and bronze. Among the pottery objects from the Xindian culture, flat-bottomed vessels were the most common, next came tripods and vessels with ring-foot, while very few were round-bottomed vessels. Many of them are of unique shapes, such as the angular-contoured basins with their handles taller than their mouth, single-handled cups with a bulging body, painted Dou-vessels with a pedestal, painted Li-tripods, and double-handled jars with three short feet. The patterns of painted decorations on the pottery vessels differ from those of other cultures. Fragments of bronze vessels, spearheads, and slag were also discovered. The presence of the bronze slag here indicates that these bronze objects were made locally rather than exchanged from other places.

²⁰⁰ GSG et al. 1988, 7-19.

²⁰¹ The Jijiachuan site once belonged to the Yongjing county, so it was attributed to the Yongjing county in some previous reports.

²⁰² HHGS 1959, 181-184; Xie R. J. 1980b, 187-220.

²⁰³ HHGS 1962, 69-71.

²⁰⁴ The Tangwang-style pottery is mainly considered to be one Bronze Age culture in the Gansu and Qinghai region.

The Jijiachuan site yielded one house and one storage-pit of the Qijia culture, another house, forty-one storage-pits, and one tomb of the Xindian culture, and plenty of stone, bone and pottery objects. The houses were of a semi-subterranean oblong structure and had a hole in the roof over a cauldron-shaped cooking stove. This kind of building has never been found in the Xindian culture before.

The potteries of the Jijiachuan type have their own style. Among them, concave bottomed vessels are the most common. Tripods occupy second place. Flat-bottomed vessels were few and those with ring-foot were not found. Very typical are single-handled cups, double-handled long-necked jars and double-handled Li-tripods. The painted designs on pottery objects included bands, zigzag patterns, rectangular spirals, linked-lozenge patterns and vertical line designs.

It should be pointed out that the double-handled Li-tripods found at Jijiachuan were extremely similar to those unearthed from the Western Zhou sites in the Central Plains. The patterns of rectangular spirals on the Li-tripods also resemble that on the bronze vessels of the Western Zhou Dynasty, indicating close relations between the Xindian and Western Zhou culture, and the fact that the ancient cultures in northwest China cannot be separated from the splendid culture in the Central Plain.

A few slag and bronze fragments were found at the Zhangjiazui site (Fig. 048). One piece of slag and spear were examined by spectrum qualitative general analysis (Table 9) and metallographic analysis.

Number	Cu	Sn	Pb	As	Sb
KG5T65:2 bronze fragment	√	√ (trace)	√ (trace)	—	—
KG5T56:9 bronze spear	√	√	√	√	√

Table 9. Compositional analysis on the samples from Zhangjiazui (adapted from Xie R. J. 1980b, 204 Table1).

The microstructure of sample KG5Y65:2 shows signs of cast and consists of solid solution dendrite-like grains and a minimum of grey particles. At the edge of the dendrite-like grains is distributed lead and a small quantity of $\alpha + \beta$ eutectoid structure. The microstructure of sample KG5Y56:9 shows signs of cast as well, consisting of α solid solution dendrite-like grains and a minimum of grey particles, and a small quantity of penniform $\alpha + \beta$ eutectoid structure.

2.3.2.3 Dahezhuang

The Dahezhuang site lies on the first terrace of the south bank of the Yellow River and about 2km to the southwest of Lianhuachun in Yongjing county. In 1959 and 1960 two excavations were conducted within an area of 1589 square meters²⁰⁵, bringing to

²⁰⁵ HHGS 1960, 9-12; ZKKG 1974, 29-61.

light the remains of 7 dwellings (1 house and 6 dwelling floors), 15 storage pits, 5 stone circles (cromlechs), and 82 tombs. Numerous stones, bones, pottery tools and articles of daily use in the Qijia culture, including one bronze knife (Fig. 049a, 1) and one bronze fragment were found. This knife is 12 cm long and is attached by some scorched millet when it was excavated inside House F7²⁰⁶.

House F7 is a square subterranean structure with an area of 36 square meters and a door opening to the southwest. At the centre of the house lies a 30cm-deep depression, in which the floor and the walls were both coated with whitewash. A circular hearth is located close to the door with pottery vessels that were still filled up to one third of their capacity with scorched millet (Fig. 049b, 1-2). The remains of the dwelling floors are all square in shape and hardened on the surface, with an average area of about 4 by 2 meters, which is surrounded by postholes. On one side of the floor is a circular hearth. The excavators believe that they probably represent the remains of small huts. The storage pits were usually circular in shape except for a few square ones (Fig. 049b, 4). Some of the pits were rather peculiar in structure, indicating that they might have served a particular purpose.

The cemetery yielding 82 tombs is adjacent to the dwelling area, indicating that they may belong to the same clan. The tombs were arranged in a very orderly manner and normally built with rectangular shaft pit. None of them yielded any trace of a coffin and the dead usually faced towards northwest. About 60% tombs belonged to children. Of particular interest is the presence of some pig mandibles in these tombs, implying that the distinction between the poor and the rich perhaps already existed. In a few cases, traces of textile impressions have been found on either the skeleton or the funerary pottery. The presence of ochre on some of the skeletons might be related to religious beliefs.

Near the cemetery, stone circles were usually found, built by flat natural gravels that were arranged in a very neat order (Fig. 049b, 3). In this area, oracle bones and the carcasses of cattle and sheep were found, highlighting the fact that they might have been connected with some primitive religious beliefs.

Among the objects unearthed are all kinds of vessels of fine red wares and sandy red-dish-brown wares. The amphora and double-looped vases with a flaring mouth, high neck and deep belly are both very characteristic of the Qijia culture. There were also many vases with a contracting mouth. The fact that their belly often has traces of smoke suggests that apart from serving as containers, they were probably used as cooking utensils. On the other hand, there are very few Zeng-steamers, Li-tripods and Ding- tripods. Among the numerous stone implements found, the most common are the knives, axes and shouldered spades. In addition, there were many bone spades

²⁰⁶ This knife (TF:7) is made of 96,96% copper, 0,02% of tin and trace other elements.

made of animal mandible or scapula. Other finds include the bone spoon, ornaments, and toys.

Radiocarbon dates²⁰⁷ resulting from two charcoal remains unearthed from F7 are 3690±95 B. P. (1725±95 BCE) and 3660 ±95 B. P. (1695±95 BCE), close to the Early Shang period.

2.3.2.4 *Qinweijia*

The Qinweijia and Dahezhuang sites were separated by one small river, Kushuigou. Several copper and bronze objects were found (Fig. 049a, 2-7) at the Qinweijia site, which was excavated in 1959 and 1960²⁰⁸. One sample (M99:6) consists of 95% copper and 5% lead, identified with an electron probe analysis²⁰⁹. Furthermore, the bronze axe (Fig. 049a, 3) and awl (Fig. 049a, 2) were identified as Cu-Pb-Sn alloy, made by casting and forging respectively.²¹⁰ The metallurgical technique seems to have been improved when compared to copper techniques.

The whole cemetery with 138 tombs is divided into two groups, one in the north (Fig. 050b) and the other in the south (Fig. 050a). The tombs of the southern group, which occupy a much larger area than those of the northern group, are distributed in two layers. The upper layer contains 99 tombs arranged in 6 rows, in which the heads of the deceased all point towards the northwest. The 8 tombs found in the lower layer are dispersed in a rather haphazard manner with the heads of the deceased all pointing to the west. Judging from the stratigraphical evidence, the tombs of the northern group were contemporaneous with those of the upper layer in the southern group while those in the lower layer of the southern group were slightly earlier in date. Of the 138 tombs, 114 dead were placed singularly, in an extended position. The other 24 were joint burials containing either two adults or one adult and one child. In the most common joint burials, the man lay in an extended position while the woman was interred in a flexed position to his left, indicating that they probably represent man and wife. The joint burials with an adult and child could very possibly be that of a parent and their child.

The appearance of the joint burials with a man and a woman suggests that the marriage system had developed from pairing to monogamy. At the same time, it implies that the man held the dominating position while the woman was subjected to a life of slavery. Archaeological evidence shows that the man and the woman were often interred at the same time, indicating that the woman was probably immolated at her husband's burial.

Most of the dead were found with tomb furniture that usually consisted of 4 or 5

²⁰⁷ ZK 1972, 55.

²⁰⁸ HHGS 1960, 9-12; Xie R. J. 1975, 57-96.

²⁰⁹ Xie R. J. 1976, 353.

²¹⁰ Appraised by the Spectrum Laboratory of Beijing University of Iron and Steel Technology.

potteries (bowl, stemmed Dou-cup, double-looped vase, vase with flaring mouth, and high necked vase with two loops) and some bone implements. About one third of the tombs have further yielded the pig's mandible, which ranges in number from a single piece in one case to as many as 68 in another. The number of pig mandibles present is a good indication of the tomb owner's wealth; therefore, this evidence suggests that the distinction between the poor and the rich had already appeared.

In addition, 73 storage pits were found, which contained potteries, stones, bones and even coppers. Among the copper objects found, awls, axes, finger rings and perforated ornaments were very common, attesting to the outstanding technological breakthrough achieved by the Qijia people.

2.3.2.5 Xinzhuangping

The Xinzhuangping site lies in the Yinchuang township, Jishishan county, Linxia Hui Autonomous Prefecture and borders the Yellow River to the north. It is about 10km from the Dahezhuang and Qinweijia sites. It was surveyed in 1989²¹¹ and one large area and a cemetery were identified as belonging to the Qijia culture. A number of stone wares, potteries and a total of 12 bronze artifacts including 5 bracelets, 6 bulbs and 1 knife were collected (Fig. 068, 1-3). The stonewares found in the Xinzhuangping site are more advanced than those found from the Dahezhuang site, however similar to those from the Qinweijia site. The excavators attributed the potteries found in the Xinzhuangping site to the Qijia culture.

2.3.6 Xihe county: Lanqiao

The Xihe county lies in the south of the Gansu Province and on the east bank of the Xihanshui. The Lanqiao site was excavated in 1982, found together with 9 graves. Over 200 potteries and a few bronzes were discovered²¹². Dou-cups and pots with a double-saddle shaped ring were very common, showing typical characteristics of the Siwa culture.²¹³ It is noticeable that some parts of the dead were broken up before they were buried in the shaft earth pit without coffins, namely they are partially broken burials (Fig. 051a). Only 3 bronzes were found, including 1 dagger and 2 bulbs (Fig. 051b).

As stated by the excavators, the 9 graves should belong to one group because the funeral object assemblage is very similar. In addition, two bone samples from Tomb M4 were dated to 3010±120 (Appendix), close to the middle and late Shang period. The excavators speculated that the Lanqiao site lasted from the late Shang period to the early Western Zhou period.

²¹¹ GSB 1996, 46-52.

²¹² GSG et al. 1987, 678-691.

²¹³ The Siwa culture is one of the Bronze Age cultures in the Gansu and Qinghai regions, characterized by pots with double saddle shaped ring, which will be discussed later.

2.3.7 Lintao county: Siwashan

The Lintao county lies in the south of the Gansu Province. Siwashan is located in the south of the Lintao county and west bank of the Taohe. In 1924, it was first excavated by J. D. Andersson²¹⁴. In the excavation of 1933, Anderson discovered 8 burials as well as 1 bronze bracelet (Fig. 052). The Siwa culture was named after the Siwashan site. The potteries found at the Siwashan site were attributed to the Siwa culture while the attribution of this bronze bracelet is still in argument.

In 1945, Siwashan was surveyed and excavated again by Xia Nai.²¹⁵ Six tombs were excavated, and no bronzes were found. Regarding the absolute date of the Siwa culture, Liang Siyong put forward that the Siwa culture existed during 1400-1100 BCE and developed from the Shajing culture²¹⁶. However, Xia Nai stated that the Siwa culture is parallel to the Shajing culture²¹⁷.

2.3.8 Zhuanglang county

The Zhuanglang county lies on the east bank of the Huluhe, found together with a few Bronze Age sites.

2.3.8.1 Shaoping village

One earth pit grave was discovered at the Shaoping village in 2000²¹⁸. A total of 86 funeral objects were found, including 85 bronze artifacts (Fig. 053) and 1 turquoise artifact. One bronze dagger and Dun (斝)-vessel were distributed respectively near the head and the feet. On both sides of the waist lie short swords. A horse skeleton lies under the feet as well as many bronze ornaments and chariot and horse fittings.

Not only the burial manners but also the bronze artifacts show the typical style of the Northern Bronzes. In light of the bronze dagger and short swords, the excavators dated the grave from the Spring and Autumn period to the Warring States period.

2.3.8.2 Xujianian village

A total of 104 graves were excavated at Xujianian in 1980²¹⁹. It is worth mentioning that few graves were buried with bronze objects (Fig. 054), the number ranges from one to five or six pieces, implying that bronze was quite precious at that time.

As we know, the Siwa culture has close relations with the Zhou culture. The Xujianian site provides such related evidence. Most of the graves were built in a rectangular earth pit. There were 7 cases of human sacrifices that lie in the niche of the tomb. Horse and chariot victims, and human being sacrifices were very common in the

²¹⁴ J. D. Andersson 1943, 179-185.

²¹⁵ Xia N. 2000, 269-310.

²¹⁶ Liang S. Y. 1935, 546.

²¹⁷ Xia N. 2000, 305.

²¹⁸ ZLB 2005, 43-46.65.

²¹⁹ ZSKKJ 1982, 584-590.

burials of the Yin and Western Zhou cultures.

2.3.9 Qingyang region

The Qingyang region lies in the most eastern part of the Gansu Province. It is in the lower middle part of the Yellow River on the Loess Plateau. Elevation ranges from 885 to 2082 meters above sea level. There are five major rivers in the Qingyang region including the Malianhe, Puhe, Honghe, Xilang, and Huluhe. Their combined annual flow is more than 800 million cubic meters. This region administratively includes the Xifeng urban district, Qingcheng county, Zhenyuan county, Heshui county, Huachi county, Ning county and Zhengning county.

2.3.9.1 Heshui county: Jiuzhan

Jiuzhan was officially excavated in 1984, found together with 75 square meters of dwelling remains, 80 burials and over 900 objects²²⁰. A total of 52 bronze artifacts were discovered in burials, including 1 dagger, 1 short sword, 1 knife, 5 armlets, 1 bell and 43 bulbs (Fig. 055a)

As stated by the excavators, the whole cemetery can be divided into two groups (Fig. 055b; Fig. 055c; Fig. 055d): one group is represented by M26 and M48, including 5 tombs in an east-west direction; the other group is represented by M1 and M17, including 72 tombs, which are all facing in a north-south direction. Furthermore, 4 tombs in an east-west direction overlies or destroys the tombs in a south-north direction, implying that the former are later than the latter.

The excavators speculated that the Jiuzhan cemetery started from the Spring and Autumn period to the end of the Warring States, or even until the Han Period based on the potteries and iron hooks found in the burials. The excavators attributed the Jiuzhan cemetery to the Siwa culture.

Both the burial manners and tomb forms discovered in the Jiuzhan cemetery have their own characteristics. A shaft pit grave with a niche was the main burial form, which is different to the shaft pit that dominated the Zhou culture. In addition, the haphazard burial is striking in the Jiuzhan cemetery while it is absent in the Zhou or Pre-Zhou culture. Therefore, the Jiuzhan cemetery provides evidence that the Siwa culture had its own characteristics though related to the Zhou culture as well.

2.3.9.2 Ning county, Zhengning county, Zhengyuan county

Since 1984, many archaeological surveys have been carried out in the Qingyang region²²¹. A considerable number of bronzes were discovered at Yuanjia village in Ning county (Fig. 057), Houzhuang village in Zhengning county (Fig. 058), Miaoqu village (Fig. 059), Hongyan village (Fig. 060), and Wujiagou village (Fig. 061) in

²²⁰ Wang/Shui 1997, 300-460.

²²¹ Liu/De 1988, 413-424.

Zhengyuan county. Comparing the bronzes to those found in the neighboring regions, Some bronzes which were collected in the Qingyang region (Fig. 062), were dated from the Spring and Autumn period to the middle Warring States. These bronzes reflect nomadic life in the steppes and were possibly related to the Xiongnu people.

2.3.10 Gangu county: Maojiaping

The Gangu county lies on the south bank of the Weihe. The Maojiaping site, situated 25km west of the Gansu county, was firstly surveyed by Pei Wenzhong in 1947²²². A few potsherds were collected from the surface in 1956²²³. In 1982 and 1983, it was officially excavated, found together with 45 graves, 29 pits and 4 houses²²⁴.

The excavators divided the remains found at the Maojiaping site into three types: 1) Shilingxia type, which is characterized by painted pottery (Fig. 063a, 5A.5B); 2) Group A; (Fig. 063a, 3.4A.4B); 3) Group B; (Fig. 063a, 3.2). The earlier period of Group A had some features of the Western Zhou culture as well as some features of the Qin culture in the Eastern Zhou period. From beginning to end, Group A (Fig. 063b, A) seems to be related and continuous, therefore providing vital clues on the formation of the Qin culture. Some remains of Group A coexisted with Group B (Fig. 063b, B) in the third layer (Fig. 063a). However, the special potteries found in Group B are absent in Group A (in Layer 4A and 4B). Meanwhile, the potteries of Group B are hardly seen in the Qin culture sites, and some similar potteries were found at Wanggong and Hezigou in the Zhuanglang county²²⁵. Therefore, Group B potteries in the Maojiaping site probably represent one new culture, namely, the Siwa culture.

2.3.11 Qingshui county: Liuping

The Qingshui county lies on the south bank of the Weihe. The Liuping village lies 25km northwest of the Qingshui county. A number of bronze daggers, knives, dagger axes, Jue-drinking wares, and cups were discovered by local peasants during 1960-1975. One big earth shaft grave and a few heavily disturbed small graves were unearthed when it was excavated in 2000²²⁶. All of the bronzes found in the graves including the stray finds, have come to a total of over 600 pieces (Fig. 064a). In addition, a considerable number of bronze horse and chariot fittings as well as a few gold wares (Fig. 064b) were found in the big graves.

The bronzes found at the Liuping site resemble those found in the Guyuan region²²⁷, in Ningxia. However, gold ornaments were rarely seen in the Guyuan region and the Central Plain. The bronzes decorated with animal motifs and patterns are closely

²²² Pei W. Z. 1987b, 208-254.

²²³ GSB 1960a, 11-51.

²²⁴ GSG 1987b, 359-395.

²²⁵ Ding G. X. 1981, 11-16.

²²⁶ Li/Nan, 2003, 4-17.

²²⁷ NXY et al. 1993, 13-56.

related to the northern people.

2.3.12 Yumen: Huoshaogou

312 tombs were excavated at Huoshaogou in Qingquan, Yumen county, Gansu in 1976, and 106 tombs were found together with copper and bronze objects. The second excavation in 1990 revealed 17 tombs, and 4 of them yielded copper and bronze metal objects²²⁸. They included implements, weapons, and ornaments, such as axes, knives, spears, awls, needles, chisels, tubes, plaques, earrings and so on. The majority was small artifacts, and big-scale vessels are scary. In the end of the 1970s, a qualitative study was carried out on 65 samples.²²⁹ In recent decades, 37 of the 65 samples have been re-examined by metallographic determination and quantitative component analysis of Energy Dispersive X-ray analysis²³⁰.

The results of the first metallurgical analysis are as follows. Half are copper artifacts, while the other half are bronzes (Table 10). Most of the bronzes are tin-bronzes; lead-bronzes come next. Only six lead-tin-bronze artifacts have been found. 60% ornaments and 40% implements are made of bronze. Of the 29 samples tested for arsenic content, only 5 were determined to contain arsenic in a small amount. Among the cast artifacts, there is a so called ‘staff of authority’ (mace head or pole top) with four goat heads decorating it (Fig. 104b, 34). Parts protrude from a hollow, suggesting that the goat heads and the base were cast separately. If so, this would be the earliest composite cast bronze product ever found in China. In addition, a stone mold for casting two arrowheads was found at Huoshaogou. The mold was made from sandstone of a moderate hardness and possessed good fire resistant properties. The surface of sandstone is easy to carve and can be used repeatedly. All data indicates that the arrowheads were probably local products²³¹.

Type/Name		Serial No.	Elements						Material and methods of testing
			Cu	Sn	Pb	As	Fe	Ag	
Ornament	Pao (dome-shaped object)	76.Y.H.M83: 3	L	N	N	-	S	T	Copper (note 4)
		M11:19	Y	N	Y	-	-	-	Lead-bronze (note1)
		M88:10	Y	N	Y	-	-	-	Lead-bronze (note1)
		M215	Y	N	Y	-	-	-	Lead-bronze (note1)
		M48:8	L	Y	Y	N	-	-	Lead-tin-bronze (note 2)
		M254:10	L	N	N	N	-	-	Copper (note 2)
	Nose ring	M206:8	L	S	N	N	-	-	Copper (note 2)
		M84	L	M	S	-	S	T	Tin-bronze (note 4)
		M47:26	L	Y	S	N	-	-	Tin-bronze (note 2)
	Earring	M47:13	L	Y	S	N	-	-	Tin-bronze (note 2), forged
		M266:1	L	Y	N	N	-	-	Tin-bronze (note 2), forged
		M127:26	L	Y	S	N	-	-	Tin-bronze (note 2)

²²⁸ BJGY 2003, 86.

²²⁹ Sun/Han 1997, 75-84.

²³⁰ BJGY 2003, 86-96.

²³¹ Sun/Han 1997, 77-78, translated in Linduff et al. 2000, 177-178.

	Bracelet	M259:13	L	N	N	N	-	-	Copper* (note 2)	
	Tube	M215	L	S	N	-	S	N	Copper (note 4), forged	
	Bar	M239:2 M266:13	Y Y	Y N	Y N	- -	- -	-	Tin-lead bronze (note 1) Copper (note 1)	
	Round object	M300 ?	L L	N M	N N	N -	- S	- N	Copper (note 2) Tin-copper (note 4)	
	Mirror Handle, Staff of authority	? M310	L L	N S	N S	N -	- -	-	Copper (note 2) Copper* (note 4)	
Utility tool	Utensil	M100:4 M254:4 M153:15	L L L	Y S Y	N S Y	N N N	- - -	- - -	Tin-bronze (note 2) Copper (note 2) Tin-lead bronze (note 2)	
Implement	Awl	M215:4	L	S	N	-	S	N	Copper (note 4)	
		M11:8	L	N	N	-	S	N	Copper (note 4)	
		M176	L	N	N	N	-	-	Copper (note 2)	
	Chisel	M84:19	L	S	N	N	-	-	Copper (note 2)	
	Sickle	M100:15	L	S	N	-	S	N	Copper (note 4)	
	Shovel	collected	Y	Y	N	-	-	-	Tin-bronze	
	Ax	M79:1	Y	N	Y	-	-	-	-	Lead-bronze (note 1)
		M299	Y	N	N	-	-	-	-	Copper (note 1)
		M64:9	Y	N	N	-	-	-	-	Copper (note 1)
		M234	Y	N	N	-	-	-	-	Copper (note 1)
M50:2		Y	N	Y	-	-	-	-	Lead-bronze (note 1)	
Knife	M219:6	Y	N	Y	-	-	-	-	Lead-bronze (note 1)	
	M244:2	L	N	N	S	-	-	-	Copper (note 2)	
	M97	Y	Y	N	-	-	-	-	Tin-bronze (note 1)	
	M127:2	Y	Y	N	-	-	-	-	Tin-bronze (note 1)	
	M84	Y	N	N	-	-	-	-	Copper (note 1)	
	M127:29	Y	N	N	-	-	-	-	Copper (note 1)	
	M278:6	L	S	N	N	-	-	-	Copper (note 2)	
	M244:2	L	N	N	S	-	-	-	Copper (note 2)	
	M252:11	L	Y	S	N	-	-	-	Tin-bronze (note 2)	
	M64:8	L	S	N	N	-	-	-	Copper (note 2)	
	M79:22	L	Y	Y	S	-	-	-	Lead-tin-bronze (note 2)	
	M19:5	L	S	N	S	-	-	-	Copper (note 2)	
	M304:15	L	Y	N	N	-	-	-	Tin-bronze (note 2)	
	M64:11	L	S	S	S	-	-	-	Copper (note 2)	
M206:20	L	Y	N	N	-	-	-	Tin-bronze (note 2)		
M103:2	L	S	N	N	-	-	-	Copper (note 2)		
M196:11	L	Y	N	N	-	-	-	Copper (note 2)		
Weapon & Hunting tool	Arrowhead	M234	Y	N	Y	-	-	-	Lead-bronze (note 1)	
		M103	Y	N	Y	-	-	-	Lead-bronze (note 1)	
		M310:9	Y	Y	Y	-	-	-	Lead-tin-bronze (note 1)	
		M79:23	Y	N	Y	-	-	-	Lead-bronze (note 1)	
		M176:8	Y	N	Y	-	-	-	Lead-bronze (note 1)	
		M219:7	Y	N	N	-	-	-	Copper (note 1)	
		M284:2	Y	N	N	-	-	-	Copper (note 1)	
		M88:7	L	N	N	-	S	N	Copper* (note 4)	
		M278:11	L	L	S	-	S	S	Tin-bronze (note 4)	
	M 299:11	L	L	S	-	S	S	Tin-bronze (note 4)		
M254:2	L	N	N	-	S	-	Copper (note 4)			
Spear	A045	L	S	N	N	-	-	Copper (note 4)		

Table 10. Results from the analysis of copper and bronze objects found in Huoshaogou, Qingquan, Yumen county, Gansu Province. Method of testing: note 1, portable radioisotope X-ray fluorescence instrument qualitative analysis; note 2,

atomic emission spectrometry qualitative analysis; note 3, spectral semi-quantitative analysis by the Gansu Geology Bureau; note 4, atomic absorption spectrometry; note 5; electron probe micro analysis; * indicates a corrected identification of materials from Sun/Han 1981, 287-301. T=Trace element; S=Small amount; M=Medium amount; L=Large amount; Y=Yes; N=No; Na=not available (adapted from Linduff et al. 2000, 182-183 Table 2)²³².

Most results of the second metallurgical analysis are in accordance with the first metallurgical analysis. However, the second one shows that there is also Cu-As-Sn, and Cu-As-Pb alloys in addition to Cu-Sn-Pb alloys. For example, only 5 of the 29 samples contained a small quantity of arsenic in the first analysis. In contrast, the second analysis shows that there are not only a few Cu-As alloys but also a number of Cu-Pb alloys (Table 11).

Lab. No.	Original No.	Average Composition (%)						Material
		Cu	Sn	Pb	As	Sb	others	
883	76YHM6:6	93.3		1.5	3.8			Cu-As (Pb)
		95.2			2.5		Fe	
887	76YHM18:1	92.1	3.4				S, Fe	Cu-Sn
		94.8	3.5					
@888	76YHM20:2	90.4	7.9				Bi, S	Cu-Sn
886	76YHM28:6	94.2						Cu-As
		93.2						
907	76YHM47:28	95.6	1.8					Cu (Sn)
		94.4	1.7					
900	76YHM50:2	98.0						Cu (As)
		96.0			1.1			
894	76YHM56:8	97.3						CU
		98.7						
898	76YHM64:9	96.1						Cu (As)
		98.4			1.2			
911	76YHM90:6	89.3	3.9		2.8			Cu-Sn-As
		91.1	3.6		2.7			
909	76YHM120:4	92.1	2.8	2.0				Cu-Sn (As, Pb, S)
		88.0	3.5	1.4	0.9	1.3	S	
884	76YHM128:8	97.4						Cu (Sn)
		96.6	1.3					
903	76YHM136:10	96.8			1.6			Cu (As)
		97.2			1.0			

²³² Sun/Han 1997, 80 Table 2; translated in Linduff et al. 2000, 182-183.

@916	76YHM170:12	93.1			1.2	4.2	Ag:1.4	CuSb(Ag, As)
		91.1			1.1	5.4	Ag:2.3	
889	76YHM176:9	95.6				1.4	S	Cu (Pb)
		96.3				1.0		
905	76YHM185:4	92.8			2.3		S	Cu-As
906	76YHM185:12	93.3			4.0			Cu-As
890	76YHM196:11	94.7					Fe:1.3	Cu (Fe)
		95.6					Fe:0.9	
896	76YHM201:4	92.0	1.9		3.6		Fe	Cu-As (Fe)
904	76YHM215:4	95.2			1.5		Fe	Cu (As)
		96.9						
@892	76YHM252:11	89.3	10.7				S	Cu-Sn
		89.9	10.1		4.3		S	
913	76YHM255:9	94.6			3.9		Ag	Cu-As
		95.3						
901	76YHM276:11	94.7					Sn, Pb	Cu
		97.3					As, Sn, Ag	
@910	76YHM299:21	84.2	15.8					Cu-Sn
@882	76YHM304:5	61.7	33.4		3.1	1.6		Cu-Sn-As (Sb)
891	76YHM304:15	91.4	5.1				S	Cu-Sn
		90.2	4.5				S	
@899	A045stray find	84.7	15.3					Cu-Sn

Table 11. Results from the quantitative composition analysis of copper and bronze objects found at Huoshaogou, Qingquan, Yumen, Gansu Province (adapted from BJGY 2003, 89 Table 2).

2.3.13 Others

A number of Bronze Age sites have been identified in the Gansu Province, found together with metal objects. In 1980, one grave was excavated at Yushugou, Yongdeng county²³³. A total of 146 bronze artifacts (Fig. 066), including a few iron objects and potsherd were found. The excavators ascribed this tomb to the Shajing culture²³⁴. However, the bronze deer figures show strong northern style. Therefore, it is debatable whether or not the grave belonged to the Shajing culture.

The Yinwoshu site, which is ascribed to the Siba culture, produced seven metal objects, including one awl, knife, arrowhead, and some bulbs²³⁵. All of them are bronzes and four of them have been analyzed metallographically. Two indicate a cast

²³³ GSBG 1981, 34-36.

²³⁴ One Bronze Age culture in the Gansu and Qinghai regions, is named after Shajing, the first representative site. It will be discussed later.

²³⁵ Sun/Han 1997, 79.

structure, another two show a hot forged structure. This site is dated slightly later than the Donghuishan and Ganguya sites.

The Ganguya in Fenglexiang, Jiuquan is a Siba culture site, dated between 1900-1600 BCE. A total of 105 tombs have been excavated at the site yielding 48 copper and bronze artifacts²³⁶. Forty-six of them have been tested by method of scanning electron microscope. They are identified as copper, arsenic, tin-bronze, tin-arsenic-bronze, tin-lead-bronze and tin-arsenic-lead-bronze. The content of arsenic is less than 6%; the content of tin is around 2%-10%; and only three samples contain over 10% tin. Three tin-bronzes contain 2% iron. The metallographic tests carried out on 30 artifacts indicate that most samples were hot forged or cast. Two tools and an arrowhead had been cold worked after casting. The types, compositions, and the technology used in the manufacturing of the artifacts found at the Ganguya site are listed in Table 12-Table 14.

Material/ artifact	Tools			Weapon	Ornament/other			Total
	Awl	Knife	Others	Arrowhead	Earring	Bulb	others	
Cu	1						2	3
Cu-Sn	2	4		3	9	3	1	22
Cu-As	2	1			3	3	1	10
Cu-Sn-As	1	2			1	1		5
Cu-Sn-Fe	1		1	1				3
Cu-Sn-Pb		2						2
Cu-Sn-As-Pb							1	1

Table 12. Materials and artifacts of the Siba culture found at Ganguya in Fengle, Gansu (adapted from Sun/Han 1997, 8 Table 4).

Material/ artifact	Tools		Weapon	Ornament/other			Total
	Awl	Knife	Arrowhead	Earring	Bulb	others	
Forging	3	3		6		2	14
Casting	3	2	2	1	2	3	13
Casting then cold working	1	1	1				3

Table 13. Manufacturing techniques and types of Siba artifacts found at Ganguya in Fengle, Gansu (adapted from Sun/Han 1997, 81 Table 5).

Material/artifact	Casting	Forging	Casting then cold working	Total

²³⁶ Sun/Han 1997, 75-84.

Cu	1	2		3
Cu-Sn	4	8	1	13
Cu-As	5		2	7
Cu-Sn-As	2	2		4
Cu-Sn-Fe		1		1
Cu-Sn-Pb		1		1
Cu-Sn-As-Pb	1			1

Table 14. Manufacturing techniques and types of Siba artifacts found at Ganguya in Fengle, Gansu (adapted from Sun/Han 1997, 81 Table 6).

The bronzes discovered from the Qin'an county before 1986 were mostly stored in the House of Culture in Qin'an county²³⁷, including swords, knives, crane hacks, ornaments, and Fu-cooking wares (Fig. 067). The antenna pommel swords, crane hacks, images of sheep, and Fu-cooking wares are all typical northern bronzes, dating from the Spring-Autumn period to the Warring States period.

Xinglin, lying 1km east of Taohe in the Min county, was surveyed in 1982²³⁸ and a few potsherds, bone wares, stone objects and two copper objects (Fig. 068, 4.5) were collected from the survey. According to the pots with double-loop ears, the Xinglin site is ascribed to the Qijia culture. In 1983 and 1984, four sites: Hongya, Baitashan, Wangtiezui and Yaozhuang in Min county²³⁹ were surveyed. Many pots with double-saddle shaped rings were found, suggesting that they belonged to the Siwa culture.

2.3.14 The Central Plain bronzes found in the Gansu Province

In addition to the above-mentioned bronzes, a small quantity of bronzes are attributed to the typical Central Plain style as well.

In 1983, one Western Zhou culture grave was discovered at Yu village in Ning county²⁴⁰, where 22 bronzes were found (Fig. 056, A). Another one was discovered at Jiao village²⁴¹, found together with some bronzes (Fig. 056, B).

A total of 16 burials and 3 horse and chariot pits were excavated at Yujiawan in Chongxin county²⁴², found together with a few bronzes, which show great similarity to those found from the Central Plain, including Ding-cooking wares, Gui-cooking wares, daggers and bulbs (Fig. 069, 1-3). The excavators assigned them to the Western Zhou period. Only a part of the bronzes have been published. One Western Zhou

²³⁷ Xu/Guo 1986, 40-42.

²³⁸ Yang Y. M. 1985, 977-979.

²³⁹ Yang Y. M. 1991, 80-81.

²⁴⁰ Xu/Liu 1985, 349-352.

²⁴¹ QYB 1989, 24-27.

²⁴² GSG 1986, 1-7.

culture grave was discovered respectively at Tianshui county in 1993²⁴³ (Fig. 069, 4) and at Miaozui and Hanjiatan of Qingyang county²⁴⁴ (Fig. 069, 5-9).

It is worth mentioning that quite a number of the Central Plain bronzes were found in the Lingtai county, which lies between Jinhe and Weihe and borders Longyuan to the north, Qifeng to the south and Guanzhong to the east. It is a region impacted by both the northern nomadic people and the Zhou culture. In 1972-1973, some Zhou culture tombs were discovered in Yaojiahe, Dongxishan, and Xiling²⁴⁵. Over one hundred bronzes were found, including Ding-tripods, Gui-round baskets, daggers, spears, bells, bulbs and even some horse and chariot fittings (Fig. 070). In addition, one Zhou culture tomb was discovered in Dongzhuang, Yawadadui, and Xinji Commune in 1983²⁴⁶, found together with a few of the classic Central Plain bronzes.

The Baicaopo cemetery, located 15km to the northwest of the seat of the Lingtai county, was excavated in 1967 and 1972²⁴⁷, yielding a total of nine Western Zhou tombs and a chariot pit. Apart from Tombs M2 and M9 that were rather well preserved, the rest had either been looted or destroyed. However, a considerable amount of tomb furniture was retained.

Tombs were mostly in the form of an oblong earth shaft. Seven tombs were medium-sized, while Tombs M6 and M9 are both small. The former were provided with a waste pit at the bottom, which sometimes contained dog skeletons. Though the wood structures have been poorly preserved, their vestiges indicate that some of the tombs were provided with outer and inner coffins, while others only had a single coffin. The tombs were all single burials. The chariot pit (Fig. 071b, C), situated between Tomb M1 (Fig. 071a) and M2 (Fig. 071b, C), consisted of a single chariot with four horses. Judging by the fact of its orientation towards Tomb M2, and the similarity between the decoration of its chariot fittings and those unearthed from Tomb M2, the chariot pit may have belonged to Tomb M2. The bulk of the tomb furniture was found in Tomb M1 and M2. The furniture consisted mostly of bronzes, including ritual vessels such as the Ding, Gui, Zeng, Zun, Yu etc., and weapons like Ge-halberds, swords, arrowheads and helmets, and tools such as axes, chisels and knives. In addition, there were all sorts of jade ornaments as well as cowries. Among the bronzes unearthed from Tomb M1 and M2, twenty-four articles were inscribed.

2.4 Discoveries of bronzes in Inner Mongolia

The Inner Mongolia Autonomous Region extends across the northern frontier of China, covering 1.183 million square km, adjoining the Heilongjiang, Jilin, and

²⁴³ Wang B. Q. 1998, 82.83.

²⁴⁴ Xu J. C. et al. 1985, 853-854, 809.

²⁴⁵ GSB 1976, 39-46.

²⁴⁶ Shi K. H. 1987, 100-101.

²⁴⁷ Chu S. B. 1977, 99-130.

Liaoning provinces in the east, and the Hebei, Shanxi and Shaanxi provinces in the south, Ningxia and Gansu to its west and bordering the Republic of Mongolia and the Federation of Russia to the north.

The bordering line extends 4221km in length. The topography of Inner Mongolia is mainly composed of plateaus, extending 3000km from the northeast to the southwest, and most of them are more than 1000meters above sea level. In this region, the area of grassland is 880,000 square km, accounting for 21.7 percent of the nation's total, the largest of China's five grasslands. From east to west, are scattered grassy marshland, typical grassland, wilderness grassland, grassy wilderness, and desert as well as hilly grassy marshlands, low wet and grassy marshland, and marshy grassland, distributed randomly anywhere.

In the east, there are many primitive forests in the Greater Xinggan Mountain Range, and in the west, there is a large area of desert centering on the Ordos Plateau. The extended areas from the plateaus are plains mainly formed by the reaches of the Yellow River and the Liaohe, known as the Hetao area and Liao-Nen area. Inner Mongolia is the distribution center of the so-called 'Ordos Bronzes' and 'Northern Bronzes'.

2.4.1 Keshenketengqi: Longtoushan

Keshentengqi lies northwest of Chifeng City. In the excavation of 1986 and 1977 at the Longtoushan site in Keshenketengqi, a total of 300 square meters were uncovered, revealing some houses, pits, ditch and one grave²⁴⁸. About 200 funeral goods were found in the graves, including bronzes, bone wares and so on. These bronzes included swords, axes, knives, chisels, awls, bulbs, etc. (Fig. 072). As stated by the excavators, the swords with a tubular handle and straight blade found at the Longtoushan site (Fig. 072, 6) are perhaps the original form of the swords with a tubular handle. In addition, these swords with a tubular handle and straight blade are the local traits of the Upper Xiajiadian culture²⁴⁹, and it developed into the curve bladed sword with tubular handle. The square bronze axes with a fan blade and inverse-triangle designs on the ring (Fig. 072, 7) are similar to the typical axes from the Shang culture. This grave is therefore dated from the late Shang to the Early Zhou period.

In light of the other objects found in the houses and pits, and especially the potteries, the whole site is attributed to the Upper Xiajiadian culture, namely ranging from before the Western Zhou to the Spring and Autumn period.

²⁴⁸ NMGY et al. 1991, 704-712.

²⁴⁹ The Upper Xiajiadian culture (about 1000-600 BCE) is a Bronze Age culture in Northeast China, roughly contemporaneous to the Western Zhou period. The culture was found mainly in southeastern Inner Mongolia, northern Hebei and western Liaoning. It will be discussed in Chapter 3.

2.4.2 Chifeng region

The Chifeng City²⁵⁰ lies southeast of Inner Mongolia. Quite a lot of archaeological expeditions were conducted in this area.

2.4.2.1 Yaowangmiao and Xiajiadian

The Yaowangmiao and Xiajiadian sites are located in the outskirts of Chifeng City. In 1960, both sites were excavated; some house remains and pits, as well as some tombs were uncovered²⁵¹.

At Yaowangmiao, 70 square meters were excavated. The cultural remains have a striking resemblance to the Shang culture of the Yellow River Valley. At Xiajiadian, 250 square meters were excavated. The cultural remains of the Xiajiadian site can be divided into two types. The remains from the lower layer are similar to those uncovered at Yaowangmiao, while the remains and tombs found in the upper layer belong to a different culture, as stated by the excavators. Apart from the shape of the potteries and stone implements, the manufacturing process and the decorations on the pottery also show that the two layers represent two distinctive cultural remains. In the report on the excavations conducted in 1935²⁵², some Japanese scholars lump these two types together and refer to them as 'Chifeng II culture'. Such a view is clearly contradicted by the stratigraphical evidence and other cultural remains found from the excavations in 1960. Furthermore, the excavators believe that the lower layer of the Lower Chifeng culture predated the Western Zhou Period (about 1100-1000 BCE) while the upper layer of the Upper Chifeng culture was not later than the Spring and Autumn period (800-700 BCE). In addition, the lower layer of the Upper Chifeng culture should not be later than the Warring States period when the cultural influence of the Yan and Qin States reached this region (400-300 BCE).

It is worth mentioning that some slag was discovered in the lower layer of the Xiajiadian site, found together with a few of the bronzes (Fig. 073).

2.4.2.2 Zhizhushan

Located near the northern fringe of the modern city of Chifeng, the Zhizhushan site is covered by layers of cultural deposits that range from 2-6.5 meters in thickness. Their stratigraphical sequence from the bottom to up is as follows: Hongshan culture, Lower Xiajiadian culture, Upper Xiajiadian culture, and the Warring States-early Han culture²⁵³.

The earliest layer is the Hongshan culture, very characteristic of the Neolithic cultures in the region. The pottery differs greatly from that of the other cultures in shape,

²⁵⁰ The Chifeng city once belonged to the Liaoning Province, now to the Inner Mongolia.

²⁵¹ ZKKN 1961, 77-81; ZKKN 1974, 111-144.

²⁵² Hongshanhou 1938, 8-24.

²⁵³ ZSKKN 1979, 215-243.

decoration, and techniques of manufacture. For instance, a sandy brown pottery vase with a large mouth is decorated near the mouth and on the belly with either an impressed zigzag design or incised lines, while the bottom has an impressed mat design. There are also some fine red potteries, Bo-vases (the so-called red-topped bowl) of the Hongshan culture and their painted decorations resemble the painted Bo-vases found in the Hougang type of the Yangshao culture. Moreover, the two are also roughly contemporaneous in date.

The Lower Xiajiadian culture is later than the Hongshan culture, and dates from the Bronze Age. It is intimately connected with the Bronze Age cultures of the Yellow River and corresponds in date to the Xia and Shang cultures. Radiocarbon tests conducted on some specimens of charcoal unearthed from ash pit H42 gives a date of 3965 ± 90 B. P. (Appendix). A study on the development of pottery shapes in light of the stratigraphical evidence has provided some clues regarding the periodization of the Xiajiadian culture (Fig. 074b). The discovery of a unique type of painted pottery is something new and rather unexpected.

The Upper Xiajiadian culture represents a much later Bronze Age culture in the region. Stratigraphical evidence shows that its lower layer is later than the Warring States-early Han remains found at the site. Judging by the date and geographical location, this culture might have something to do with the Shanrong and Donghu tribes of ancient China²⁵⁴.

The last and latest cultural remains found at the Zhizhushan site are dated from the Warring States and early Han period. The artifacts unearthed from this layer are practically identical to those of the same period found in the Central Plain, indicating that the power of the State of Yan (燕) had reached this region during the Warring States period. A few bronzes (Fig. 074a) and iron objects were found, dated to the Warring States and Han period. In addition, the discovery of a Qin Dynasty pottery measure is proof that the region subsequently came under the control of the succeeding Qin Dynasty.

2.4.3 Linxi county

The Linxi county lies in the north of Chifeng City and borders Keshenketengqi to the west.

2.4.3.1 Susitai

One tomb buried with bronze and gold objects (Fig. 075, 1-3), potteries, and turquoise was uncovered at Susitai village, Shiertu township, Linxi county in 1981²⁵⁵. The excavators attributed the tomb to the Xianbei people and dated it to the end of the

²⁵⁴ ZSKKN 1979, 242.

²⁵⁵ Wang G. 1997, 461-462.

Eastern Han dynasty. The bronze Fu-cooking ware, comprised of two straight ears and a round base collected from the Dayingzi township²⁵⁶(Fig. 075, 4) and another one from Susitai (Fig. 075, 1) are typical cooking wares used by the ancient northern people.

2.4.3.2 *Jinggouzi*

The Jinggouzi village lies 40km northwest of the Linxi county. One tomb with a stone structure was unearthed in 1996²⁵⁷, found together with a few potteries, bronzes, and stonewares (Fig. 076a). The excavators first ascribed this tomb to the Upper Xiajiadian culture.

31 tombs were found at the excavation in the west district of the Jinggouzi village in 2002²⁵⁸. Apart from the case that tomb M21 destroys pit H2 of the Upper Xiajiadian culture, that one tomb overlies or destroys the other has not been found. Furthermore, the structure, burial manners, and funeral objects of these tombs are quite similar so they may well have existed at the same time. The charcoal sample from tomb M17 is dated to 2115±65 B. P., thus it is inferred by the excavators that these tombs were later than the Upper Xiajiadian culture.

As we know, the Upper Xiajiadian culture is characterized by the tombs with stone structure and the dead were normally buried in an extended position lying on their stomach. However, the Jinggouzi cemetery is remarked by joint burials, animal victims and potteries that were absent in the Upper Xiajiadian culture. No stone structured tombs were found at the Jinggouzi cemetery. Besides, the Li-tripods of the Upper Xiajiadian culture and the Jinggouzi cemetery are quite different. Despite some similarities in the potteries, such as the straight high neck and layered ring-Li with handle on the abdomen as well as some bronze wares, the characteristics of the Jinggouzi cemetery display a different style. The majority of the bronzes found in the Jinggouzi cemetery consist mainly of small ornaments as well as a few weapons and implements (Fig. 076b).

Wang Lixin etc.²⁵⁹ put forward that the Jinggouzi cemetery may represent one new culture. Among 28 tombs, 25 tombs were buried with animal victims, including horses, oxen, sheep, donkeys, mules and so on. Dog is only in one case. Neither pig bones nor any agricultural implements were found. It implies that animal husbandry played a big role at that time. Some other animals were also identified, including deer, foxes, roes, whorls and mussels as well as a great quantity of bone arrowheads, which implies that fishing, might have been very significant at that time.

²⁵⁶ Wang G. 1994, 133.

²⁵⁷ Wang G. 1998, 1-3.

²⁵⁸ Wang L. X. et al. 2004, 6-18.

²⁵⁹ Wang L. X. et al. 2004, 16.

Wang Lixin²⁶⁰ suggests that the Jinggouzi cemetery had quite a close connection with the Donghu (东胡) people in view of its location, time and industry.

Apart from three tombs being heavily destroyed and only one being well preserved, the other 27 tombs were very or partially disturbed. They seem to have been disturbed at the same time, which was very common in the Kayue culture. The second disturbance should be looked upon as some kind of special burial custom.

It is worth noting that the heavily destroyed tomb built with stone walls and a stone cover and unearthed in 1996 at the middle of the Jinggouzi village was attributed to the Upper Xiajiadian culture by Wang Gang²⁶¹. The sand-inclusioned pots with a wide flared mouth and ball-shaped abdomen (Fig. 076a, 2-4) are quite different to those found in the west region of the Jinggouzi cemetery. Furthermore, some scholars questioned whether the tomb found in 1996 belongs to the Upper Xiajiadian culture²⁶².

2.4.4 Ningcheng county

The Ningcheng county lies east of Inner Mongolia and south of Chifeng City. It is situated near the Kundu River, which is the upper section of the Laohahe.

2.4.4.1 Nanshan'gen

Nanshan'gen is located on the south bank of the Kundu River. In the survey of 1958 at Nanshan'gen²⁶³, a total of 71 bronzes were found, including 1 helmet, 3 daggers, 1 spear, 2 Zun (罇), 1 scabbard, 2 swords, 4 knives, 4 axes, 3 arrowheads, 1 nail, 28 plaques bulbs and so on (Fig. 077a). The excavators ascribed them to one grave and dated them to the Eastern Zhou period.

In 1961, Nanshan'gen was surveyed and excavated again, yielding a total of 236 square meters, including 14 pits and 9 tombs²⁶⁴. The excavators believed that this site contains two different cultural remains, similar to those found at Xiajiadian in Chifeng city²⁶⁵. Many potteries and bronzes (Fig. 077b) found from the Upper Xiajiadian layer were marked by distinctive local characteristics. In the case of some large tombs, these potteries and bronzes were found side by side with typical bronze ritual vessels of the Spring and Autumn period (Ding-tripods, Fu-vessels, and Gui-vessels) often encountered in the Central Plain. This fact suggests that the tombs probably date from the Spring and Autumn period.

In 1963, stone structured Tomb M101 was uncovered²⁶⁶, found together with over 500 pieces of bronzes and a few gold, bone and stone wares (Fig. 077c). The bronzes

²⁶⁰ Wang L. X. et al. 2004, 17.

²⁶¹ Wang G. 1998, 3.

²⁶² Guo Z. Z. 2002; Jin F. Y. 1987, 177-208.

²⁶³ Li Y. Y. 1959, 276-277.

²⁶⁴ ZKKN 1975, 117-140.

²⁶⁵ ZKKN 1974, 111-114.

²⁶⁶ LNZ et al. 1973, 27-38.

included vessels, weapons, implements, and chariot and horse fittings. The cultural elements of the funeral objects are quite complicated. The bronze vessels, such as Ding, Li and Bu (Fig. 077c, 7.8.11) are considerably similar to the pottery-Ding, pottery-Li and two-eared pots that were found at Hongshan, in Chifeng city²⁶⁷. These potteries carried local traits in addition to some kinds of knives (Fig. 077c, 77-79; 81-85), swords (Fig. 077c, 56-69), axes (Fig. 077c, 16-22), scabbards (Fig. 077c, 73-76), plaques and horse and chariot fittings. Furthermore, some objects are similar to those found in the neighboring region, such as the curve bladed swords with a curved ridge (Fig. 077c, 56), knives with protruding teeth on the handle (Fig. 077c, 80), axes (Fig. 077c, 23) and arrowheads with three ridges (Fig. 077c, 67). In addition, some typical Central Plain bronzes also occupied a small quantity, including Ding-tripods (Fig. 077c, 5.6), Fu-cooking wares (Fig. 075c, 3), Gui-vessels (Fig.077c, 2), daggers (Fig. 077c, 70-72), and spears (Fig. 077c, 68.69), which existed from the end of the Western Zhou period to the early Eastern Zhou period. The excavators attributed Tomb M101 to the Upper Xiajiadian culture because it displays not only the sharp local traits but also connections with the Central Plain. Compared to the other tombs of the Upper Xiajiadian culture, Tomb M101 is bigger in size and more in quantity of funeral furniture in addition to some gold wares. Therefore, Tomb M101 probably belonged to a rich person with a higher social status at that time.

About 120 meters west of Tomb M101 (Fig. 077e), another stone-chambered Tomb M102 was uncovered²⁶⁸, found together with a few bronzes and bone wares (Fig. 077d). Around the skull, 25 pieces of bronze cluster ornaments are distributed; bronze knives and a mirror lie near the waist; one bone board incised with patterns is situated under the right arm; horse and chariot fittings lie to the upper right of the body; and dozens of bronze bulbs are scattered around the upper part of the body. It is worth noting that the incised bone board (Fig. 077d, 22) which describes a hunting scene and horse and chariot in vivid detail, is quite precious as it provides evidence about how the ancient life was and how the chariot functioned. The excavators also ascribed this smaller Tomb M102 the Upper Xiajiadian culture.

2.4.4.2 Xiaheishigou

The tomb located at Xiaheishigou, Dianzi township, Ningcheng county was found in 1985²⁶⁹, which was heavily destroyed and built with stones. It has a rectangular plan and measures 3.1x2.3x2.1m, yielding over 400 pieces or sets of funeral objects, including 21 ritual bronzes, 46 tools, over 70 chariot and horse fittings, 28 weapons, nearly 200 ornaments, over 20 gold articles and 34 utensils (Fig. 078). Among the bronze vessels, a Gui (簋) inscribed “许季姜簋” shows a quite Central Plain style,

²⁶⁷ Hongshanhou 1938.

²⁶⁸ ZSKKD 1981, 304-306.

²⁶⁹ Xiang/Li 1995, 4-22.

while the round-bottomed vessels and quaternary jars present a northern frontier style. The excavator ascribed this tomb to the Upper Xiajiadian culture and dated it between the mid-late Zhou Dynasty and the Spring and Autumn period.

2.4.4.3 Other sites

Since 1958, a small quantity of burials with bronzes were found or collected successively in Ningcheng city, including Beishanzui, Wafangzhong, Xiaoheishigou, Tianjuquan, Liangjiayingzi, and Sunjiagou²⁷⁰(Map 2.03). They were attributed to the Upper Xiajiadian culture, mostly dating from the late Western Zhou period to the early Spring and Autumn period. It is worth noting that the short swords with curved blades (Fig. 079A, 4; B,1; F, 9-12) were very common. Some swords characterized by a handle with naked figure (Fig. 079F, 12) are very interesting, providing the evidence about the ancient people and their religions.

The tentative digging in 1960 at Xiaoyushulinzi which lies on the south bank of the Laoha River in Ningcheng City, revealed the remains of two houses and two pits²⁷¹, found together with a few potteries, stone and bone wares, and one bronze knife (Fig. 079F, 13). The excavators attributed this site to the Lower Xiajiadian culture, parallel from the Yinshang to the Western Zhou period.

2.4.5 Wengniuteqi

2.4.5.1 Dapaozi

Wengniuteqi lies on the south bank of the Xilamulunhe. One tomb was excavated at Dapaozi village, Wulanaodu Commune, in Wengniuteqi in 1981²⁷², found together with bronze swords and potteries (Fig. 080). The potteries, such as red sand-inclusioned Dou (Fig. 080, 10), Li-cooking tripods (Fig. 080, 12) and curve-bladed knives (Fig. 080, 3-4, 8-19) were very common in the Upper-Xiajiadian culture, mostly parallel to the Middle Western Zhou period. However, the curve-bladed swords with a tubular handle (Fig. 080, 1-2) are simple and primitive.

2.4.5.2 Toupaizi

Three big bronze cooking wares were found in 1981 at Toupaizi village, Jiefangyingzi Commune²⁷³, including one Yan-tripod, one Li-tripod with a raised line, and another Li with a glutton motif (Fig. 081). According to the metallographic structure, these three bronzes are made of tin-lead-copper alloy. Most scholars ascribe them to the Middle Shang culture while Su He²⁷⁴ put forward that they may well have belonged to the Lower Xiajiadian culture, because the carapace-bone-script on the bronze Yan-

²⁷⁰ Jin F. Y. 1985, 23-59.

²⁷¹ NMGG 1965a, 619-621.

²⁷² Jia H. E. 1984, 50-54.

²⁷³ Su H. 1982, 1-4.

²⁷⁴ Su H. 1982, 4.

tripods may represent the title of one ancient clan, which existed during the Shang period and had a close relationship with the Shang culture.

2.4.6 Aohanqi

2.4.6.1 Tiejianggou cemetery

Aohanqi is situated east of Inner Mongolia. Tiejianggou village is located 6km southwest of the Xinhui township. In the excavation of 1991, a few tombs belonging to the Warring States were found²⁷⁵. Three tombs were heavily destroyed with many funeral objects (Fig. 082). Another two tombs were excavated without funeral objects. These objects provide new clues about the cultural visage in the west Inner Mongolia region during the Spring-Autumn period and the Warring States period.

The bronze bird-like figures and loop-headed knives are very common in the Tiejianggou cemetery. Wild pig motifs are frequently used to decorate on the bronze. Not any tri-feet pottery vessel is found. All these characteristics differ to those of the Upper Xiajiadian culture. Nevertheless, both of them have some similarities, such as the spring-shaped earrings, ball-shaped ornaments, and the hand-made techniques used in the pottery.

2.4.6.2 Zhoujiadi cemetery

The Zhoujiadi cemetery lies 800 meters west of the Gulubanhao Commune, in Aohan Banner. A total of 54 tombs were excavated in 1981²⁷⁶, which were situated under the second layer-Upper Xiajiadian culture, or under the surface and even part exposed themselves to the surface. All of the tombs were built in earth shaft pits in the direction of north-west to southeast. Most of the dead lie in an extended position facing upwards; a few of the dead lie in an extended position on their sides; a small quantity consist of secondary burials and joint burials (Fig. 083a, A).

Tomb M45 was well preserved with a considerable number of funeral objects (Fig. 083b), providing evidence on what the ancient people looked like, which tribe they belonged to and how the leather belt worked and so on. For example, the discovery of the braid is in accordance with the description in ancient documents²⁷⁷ or wall paintings about the Donghu people, thus it is the first time we can prove that the creators of the Upper Xiajiadian culture, namely the Donghu people had braid. The well-preserved leather belt with scabbards, which was also seen at Nanshan'gen²⁷⁸, is the earliest complete set that has been found, showing how they functioned together. It

²⁷⁵ Shao G. T. 1992, 84-90.

²⁷⁶ ZSKKN 1984, 417-426.

²⁷⁷ See <后汉书·乌桓鲜卑列传 (Hou Han Shu · Wuhuan Xianbei liezhuan)>中描述东胡后裔乌桓: 以髡头为轻便。妇人至嫁时乃养发, 分为髻。<The history of the Latter Han · Biographies of Wuhuan and Xianbei> says: it is a great convenience to shave their heads. The women begin to keep hairs before getting married for making a bob.

²⁷⁸ LNY et al. 1973, 27-38; ZKKN 1975, 117-140.

is worth mentioning that it differs from those found at the Maoqinggou site.²⁷⁹ The excavators inferred that the different ways in how the bronze belt buckles and buttons work shown in the Zhoujiadi and Maoqinggou sites may represent two different people in northern China.

As stated by the excavators, the Zhoujiadi cemetery belonged to the Upper Xiajiadian culture, parallel to the Spring and Autumn period on the basis that the object assemblage (Fig. 083b, 1-14) resembled those from the other typical Upper Xiajiadian culture sites, such as Nanshan'gen in Ningcheng city²⁸⁰, Zhizhushan in Chifeng city²⁸¹ and so on.

2.4.7 Liangcheng county

The Liangcheng county lies in central Inner Mongolia.

2.4.7.1 Yinniugou cemetery

The Yinniugou cemetery lies 2km northeast of Maoqinggou, and 70km northeast of Huhehaote city. In the excavation of 1982²⁸² and 1997²⁸³, 15 and 23 burials were found respectively (Fig. 084e). All of the 15 tombs excavated in 1982 were a rectangular shaft earth pit; 9 tombs were in the direction of west and east; 6 in the direction of north and south. The former were normally buried with animal victims and iron objects without a coffin and outer coffin, and the dead lay in an extended position facing upwards; however, animal bones were absent in the latter and only 8 funeral objects were found together from the 6 tombs, although 2 of them had no funeral objects. It was therefore inferred that the tombs facing in a north-south direction belonged to the Han people, while the tombs facing in an east-west direction belonged to the Xiongnu people. This cemetery provides good evidence regarding the integration of the ancient northern people and Central Plain people.

The 23 tombs discovered in 1997 can also be divided into two groups: 16 tombs in a north-south direction and 7 tombs in an east-west direction. Four of the tombs facing in an east-west direction had wood coffins and some animal bones (Fig. 084a-c). The excavators suggested, that the differences between the north-south and east-west direction tombs are less than when compared to the tombs excavated in 1982, and that the cemetery was parallel to the late Warring States period in light of the comparison of the belt hooks (Fig 084d), which were partly influenced by the Central Plain. Furthermore, the Yinniugou cemetery and the neighboring cemetery of Maoqinggou²⁸⁴ were probably continuously built by the same people.

²⁷⁹ Tian G. J. 1983, 7-24.

²⁸⁰ ZKKN 1975, 117-140.

²⁸¹ ZSKKN 1979, 215-243.

²⁸² NMGG 1984, 26-32.

²⁸³ NMGY et al. 2001, 278-327.

²⁸⁴ It will be discussed in the next section.

2.4.7.2 Maoqinggou cemetery

The Maoqinggou cemetery lies southwest of the Liangcheng county (Fig. 085d). A total of 79 Bronze Age and early Iron Age tombs were found together with weapons, tools, ornaments and implements for daily use and animal bones (Fig. 085a-c) in the excavation of 1979²⁸⁵.

All of the tombs were distributed densely with rectangular earth shaft pits. A few of them had coffins or outer coffins. Most of them were built in an east-west direction and a small quantity lying the south of the cemetery were built in the north-south direction (Fig. 085e). A set of assemblages were characterized by different kinds of bead necklaces, northern bronzes, and potteries. The bronze objects included belt buckles, bird shaped plaques with double birds, belt ornaments, swords, daggers, spears, three-ridged arrowheads with wings and three-winged arrowheads with a tubular handle, crane hacks and horse fittings. The potteries included round abdomen shaped pots with small mouth and brown pots with ears (Fig. 085a-c). Some objects, like swords, and plaques with double birds, or rectangular tiger-shaped plaques were made of iron instead of bronze.

As stated by the excavators, the Maoqinggou cemetery is one typical cemetery, which belonged to the ancient northern nomadic people during the late Spring and Autumn period to the late Warring States period, similar to the Gongsuhao, Taohongbala, Hulusitai, Yulongtai and Xigoupan cemeteries²⁸⁶. The quantity of animal victims is quite less in comparison to the number of the Gongsuhao and Taohongbala cemeteries.

It is worth mentioning that a special kiln was discovered near the cemetery though only a small number of coarse and simple potteries were found. In addition, the excavators pointed out that the tombs facing in a south-north and east-west direction may have belonged to two different ethnic groups. The burial manners and funeral objects of the tombs facing in a south-north direction show great similarities to those from the Central Plain, indicating that the people in the Maoqinggou region were probably engaged in agriculture.

2.4.7.3 Guoxianyaozi

The Guoxianyaozi cemetery is located 1km northeast of the Guoxianyaozi township, about 400km northwest of the Liangcheng county and in the Manhanshan region. The Maoqinggou cemetery lies 40 km southeast of Manhanshan. A total of 19 undisturbed graves and 6 damaged graves were excavated, and 6 grave funeral objects were collected in 1983²⁸⁷ (Fig. 086c).

All of the graves were narrow rectangular earth shaft pits, which is sometimes

²⁸⁵ NMGG 1986, 227-315.

²⁸⁶ These five cemeteries will be discussed later.

²⁸⁷ NMGY 1989, 57-81.

furnished with a niche and a subsoil platform. Normally, the dead were buried singularly in an extended supine position, with the head pointing to the east. Not any kind of coffin is discovered. Animal sacrifices were very common in burials, including horned cattle, pigs, dogs, and red deer. Funeral objects consisted mainly of bronzes such as plaques, buttons, rings and tubular ornaments, along with various stone beads and a small number of bone ornaments (Fig. 086a-b). Each grave generally had one pottery. As for weapons and tools, there were only bronze knives, bone arrowheads and bone bow-ends found.

In terms of the distribution and forms of these graves and the evolutionary relations of their funeral objects, the excavators divided the Guoxianyaozi cemetery into two phases. The first phase is roughly parallel to the late stage of the Spring and Autumn period; the second phase is approximately equal to the late Spring and Autumn period to the early Warring States period.

Many of the bronze ornaments were typical Ordos objects. In contrast, neither the bronze weapons and harness which were very common in the Taohongbala cemetery nor the large belt ornaments which are often seen in the Maoqinggou cemetery were found in the Guoxianyaozi cemetery. On the other hand, the Guoxianyaozi and Maoqinggou cemeteries yielded more potteries than the other graves in the Ordos region.

2.4.8 Hangjinqi

2.4.8.1 Taohongbala cemetery

Hangjinqi lies in the northwest of the Ordos Plateau. Taohongbala village lies 45km southeast of Hangjinqi. A total of 7 graves were unearthed in 1973.²⁸⁸ All of the tombs were built in a rectangular shaft pit. Both the burial manners and funeral objects are quite similar, so they may well have existed at the same time. Only grave TaoM1 and TaoM2 were in a good state of preservation. Animal victims, bronze weapons, implements, ornaments, and horse fittings were very common (Fig. 087). According to the antenna-pommel bronze short swords (Fig. 087, 41), the excavators dated them to the late Spring and Autumn period, which corresponds to the radiocarbon date cal. 848-400 BCE (Appendix) from the wood of grave TaoM1.

2.4.8.2 Aluchaideng

Aluchaideng is situated in the Ordos Plateau, 40km southeast of Hangjinqi and 4km northeast of the Taohongbala village. One group of gold and silver objects were accidentally found in the winter of 1972. According to the remaining human bones and animal victims, they may have belonged to two barely destroyed tombs²⁸⁹. This

²⁸⁸ Tian G. J. 1986, 203-219.

²⁸⁹ Tian/Guo 1986, 342-350; Tian/Guo 1980, 333-338.

group included 282 pieces of gold objects with over 4kg of weight, 5 pieces of silver objects and a few stone beads (Fig. 088).

It is possible that the people of a high status rather than the common people in the Xiongnu society would have owned these delicate gold objects²⁹⁰. The model of the gold crown (Fig. 088, 1-3) is quite lifelike: an eagle with spreading wings and stretching claws stands on the motif of a wolf biting a sheep; and a crown band with animal designs lies underneath the crown. This is the unique Hu-crown (胡冠).²⁹¹ All of these gold and silver objects were largely decorated with animal motifs, showing strong Ordos's characteristics. In addition, the gold necklace found in Aluchaideng was also discovered in Xigoupan²⁹²; a similar silver necklace was unearthed at Yulongtai²⁹³ and Waertugou²⁹⁴ (Fig. 133). Furthermore, in light of the incised Chinese characters on the gold plaque, this group of objects were dated to the late Warring States period.

2.4.9 Zhungerqi

2.4.9.1 Xigoupan

Zhungerqi lies in the west of Inner Mongolia and most eastern part of the Ordos plateau. Xigoupan lies in the north of Zhungerqi. Three tombs were unearthed in 1979²⁹⁵ and only tomb M2 was well preserved, found together with animal victims and a number of gold, silver, and bronze objects (Fig.089). Several iron objects were found from tomb M1, however the funeral objects of tomb M3 largely consisted of bronzes. The excavators regarded the antenna pommel sword (Fig. 089, 14) as the transitional type between the antenna-headed and ring-headed sword. Accordingly, they dated M2 to the early Warring States period. Furthermore, in light of the incised Chinese character²⁹⁶ on the silver Jieyue-horse masks (see Fig. 089, 35), Tomb M2 is probably related to the Zhao (赵) State (ca. 300-200 BCE).

2.4.9.2 Baohaishe

A total of 22 bronzes were collected from Baohaishe in 1984²⁹⁷, including Dou-vessels, covers, buckles, axes, chisels, knives, loops, bulbs, beads, tubes, plaques and so on (Fig. 090). It is more than likely that they belonged to one grave. The shape and design of the two Dou-vessels shows a typical Central Plain style. By contrast, most

²⁹⁰ Tian/Guo 1986, 348.349.

²⁹¹ See <后汉书, 輿服志>: 武冠, 一曰武? 大冠, 诸武官冠之。侍中, 中常侍加黄金珥, 附禅为文, 貂尾为饰, 谓之赵惠文冠。This gold crown was probably used by the military attaché of the Xiongnu people in light of the ancient document.

²⁹² YKW et al. 1980, 1-11.

²⁹³ NMGB et al. 1977, 111-114

²⁹⁴ NMGXJ 63, Plate 80-93.

²⁹⁵ YKW et al. 1986, 351-365; YKW 1980, 1-10.

²⁹⁶ 兩.

²⁹⁷ YKW 1987, 81-83.

of the other bronzes display the typical style of northern bronzes, dating to the Spring and Autumn periods, as suggested by the excavators.

2.4.9.3 Yulongtai

The Yulongtai village lies north of Zhungeerqi. In 1974, a group of bronzes were collected from the Yulongtai village and one grave was excavated in 1975²⁹⁸, found together with animal victims, bronzes, iron and bone objects and so on (Fig. 091). The shape of the bronze buckles, buttons and knives as well as iron crane hacks, and gag bits are similar to those found at the Taohongbala and Xigoupan sites. They are accordingly dated back to the late Warring States period.

2.4.9.4 Sujigou

A group of bronzes in typical Ordos style were collected from the Sujigou village in Zhungerqi in 1962²⁹⁹, including figures of deer, horses, beaks of bird, animal heads and so on (Fig. 092). They may have come from the same storage pit.

2.4.10 Yijinhualuoqi: Ming'anmudu and Shihuigou

Yijinhualuoqi lies south of the Ordos Plateau. The Ming'anmudu village is located 5km southeast of the Buertaige township, Yijinhualuoqi. One tomb was found from the Ming'anmudu village in 1988³⁰⁰, found together with disturbed horse bones, 80 pieces of bronzes, and 2 potteries (Fig. 093, 1-19). Since the bronzes are similar to those from the neighboring areas, this tomb was dated from the end of the Spring and Autumn period to the early Warring States period.

A total of 16 silver objects and 15 bronzes were collected from one grave at Shihuigou in 1984³⁰¹. It was the first time that such silver objects with a tiger biting a deer were found in the Ordos region (Fig. 093, 20-25). Similar bronze objects were found at Fanjiayaozi³⁰² (Fig. 093, 32-34) and Guoxianyaozi in Inner Mongolia and the Chenyangchuan village in Xijie, Guyuan County, Ningxia. Similar gold objects were also stored in Inner Mongolia and discovered in Nianfangqu³⁰³. Furthermore, the motif characterized by two tigers biting each other is seen on a silver plaque, which is very similar to the gold plaque found at the Aluchaideng site.

The silver hedgehogs, goat shaped buttons, insoles and tortoise-shaped ornament present a highly developed metallurgical technique. Comparing the silver and bronze objects to those found from the neighboring regions, this grave is dated back to the late Warring States period.

²⁹⁸ NMGB et al. 1986, 366-371; NMGB 1977, 111-114.

²⁹⁹ Gai S. L. 1965, 44-46.

³⁰⁰ YKW et al. 1992, 79-81.

³⁰¹ YKW 1992, 91-96.

³⁰² Li Y. Y. 1959b, cover 3.

³⁰³ YKW 1991, 405-408.

2.4.11 Dongsheng city: Nianfangqu

The Dongsheng city lies south of the Ordos Plateau and borders Yijinhuoluqi to the north. In 1988³⁰⁴, a group of gold and silver objects as well as many agate and turquoise beads were found from the Nianfangqu hoard at the Tala township, which lies 15km northeast of the Dongsheng city. The gold plaques decorated with a tiger and wolf biting and fighting each other (Fig. 094, 1) and gold ornaments with two dragons (Fig.094, 4) are very similar to those found from the Aluchaideng (Fig. 088) and Xigoupan (Fig. 089) sites. It is worthwhile mentioning that the form of the tiger closely resembles the bronze ones, which were found at Guoxianyaozi (Fig. 086).

All of the objects found from the hoard consisted mainly of belts and necklace ornaments. They may have belonged to one noble person instead of one normal civilian. According to the ancient documented record³⁰⁵ on the objects, this gold and silver hoard found in Nianfangqu was dated to the late Warring States period.

2.4.12 Baotou: Xiyuan

The Xiyuan cemetery lies 20km east of Baotou city. A total of 7 tombs and 2 altar pits of the Spring and Autumn period were excavated³⁰⁶, found together with over 160 bronzes, 42 bone objects and quite a lot of stone ornaments (Fig. 095). It is worth mentioning that no pottery was unearthed at the Xiyuan cemetery and no dwelling remains were found in the neighborhood.

These seven tombs were all earth shaft pits with a side pit and a subsoil platform, without coffins. Animal victims were very common. For example, 11 sets of animal victims were found from altar pit J1 and one round pit of pebbles on the right subsoil platform (Fig. 095, 10). In addition, the dead were placed in a supine and extended position. The funeral objects were composed mainly of small belts and necklace ornaments. However, horse and chariot fittings, weapons, and implements were very rarely seen in the Xiyuan cemetery.

The Xiyuan cemetery differs to the Taohongbala and Xigoupan sites in both burial patterns and the type of bronze objects. It resembles the Guoxianyaozi cemetery in bronze assemblages but differs in tomb forms. Therefore, it is difficult to tell the cultural ascription of the Xiyuan cemetery. Based on the comparison of the bronzes, the excavators dated the cemetery from the late Spring and Autumn period to the early Warring States period.

2.4.13 Other sites

Apart from the above-mentioned sites, quite a number of bronzes were also collected

³⁰⁴ YKW 1991, 405-408.

³⁰⁵ <史记, 六国年表>: 赵武灵王二十年 (前 306 年)“西略湖地, 至榆中, 林胡王献马”; <史记匈奴列传>: 而赵武灵王亦变俗胡服, 习骑射, 北破林胡楼烦。

³⁰⁶ Liu. H. Z. 1991, 13-23.

or excavated from other places in Inner Mongolia.

Three graves were unearthed at the Hulusitai village, in Wulatezhonghoulianheqi³⁰⁷, found together with a group of bronzes (Fig. 096). The excavators dated them to the early Warring States period by comparing the burial manners and funeral objects to those found from the Taolongbala, Yulongtai, Maoqinggou, Sujigou, Xigoupan sites and so on. One bronze knife (Fig. 097, 1) collected from the northwest of the Salaqi Town³⁰⁸ resembles one found from a grave at Shuijiangoumen in Tuyouteqi³⁰⁹ (Fig. 097, 3), dated back to the Warring States period.

In the survey of 1988 at the Nanpaoziya village of Kulunqi, a number of potteries and stone implements were collected from the surface³¹⁰. One broken bronze knife was also found (Fig. 097, 13). The excavators ascribed them to the Lower Xiajiadian culture. An animal headed sword, some belt hooks and buckles were found in one tomb at Goulitou, Xinghe county in 1988³¹¹ (Fig. 097, 9-12); some horse and sheep bones were also buried in the tomb; the sword (Fig. 097, 12) is similar to the one found at the Xigoupan site. Some ancient bronze or iron objects were also found in the tombs at Chenbaerqi³¹², Hulunbeiermeng, northeast of Inner Mongolia (Fig. 097, 14-34); tomb M1B was buried with 25 sets of skeletons and animal bones; the cultural elements of this tomb is complicated.

2.4.14 Summary

As mentioned in Chapter 1, the Northeast Complex as defined by Pak³¹³ will not be an emphasis in this study because this complex is characterized by the bronze swords with curved blades which highlights a different system compared to the typical northern bronze system. However, many remains in the South of the Yanshan Complex were traditionally attributed to the Upper Xiajiadian culture, which was one typical bronze-using culture in the Northeast Complex, distributed mainly to the north of the Yanshan region.

In order to clarify the differences between the Upper Xiajiadian culture and the cultures in the South of the Yanshan complex, the copper and bronze artifacts of the Upper Xiajiadian culture distributed in Inner Mongolia have been also provided, including Longtoushan, Yaowangdian, Xiajiadian, Zhizhushan, Jinggouzi, Nanshan'gen, Xiaoheishigou, Beishanzui, Wafangzhong, Tianjuquan, Liangjiayingzi, Xiaoyushulinzi, Dapaozi, Tiejianggou, Zhoujiadi sites. It is hoped that this will not only help the readers to distinguish the south of the Yanshan Complex from the Upper

³⁰⁷ Ta/Liang, 1986, 223-226; 1980, 11-18.

³⁰⁸ Shi Y. T. et al. 1997, 18.

³⁰⁹ Zheng L. 1965, 51.

³¹⁰ Hao W. B. 1996, 11-14.

³¹¹ Cui L. M. 1994, 473.

³¹² NMGG 1986b, 273-283.

³¹³ Pak Y. J. 1996, 54-207.

Xiajiadian culture but also to have a comprehensive grasp on the metallurgical and cultural development in different parts of the long and narrow Inner Mongolia region.

Chapter 3 The Northwest Complex

It is well known that the northwest of China was the most significant passageway for cultural interaction and exchange, between China and Central Asia during the prehistoric and early historic periods. The Gansu and Qinghai provinces are administratively the main components of this region.

The Gansu and Qinghai provinces are located along the upper reaches of the Yellow River, which passes through the southern part of this region. Arable land is located in the river valleys of many tributaries of the Yellow River, including the Taohe, Weihe, Daxiahe, Jinghe, Zulihe, Huluhe, Bailongjiang, Shiyanghe, Shulehe, Danghe and so on (Map 7). The landscape of the Gansu Province is very mountainous in the south and flat in the north. The mountains in the south are part of the Qilianshan range where many archaeological sites have been discovered in a belt that changes from a sub humid to a semiarid climate. The Qinghai Province is located on the northeastern part of the Tibetan Plateau. The Yellow River originates in the middle of the province, while the Yangzi and Mekong rivers have their sources in the southwestern part. The average elevation of the Qinghai Province is over 3000 meters above sea level. Mountain ranges include the Tanggula and Kunlun Mountains.

Archaeological sites are located in the river valleys and the Hexi Corridor. In general, the Corridor plain has abundant arable land resources, but the climate is dry with only scanty and sporadic rainfall that decreases from the southeast to the northwest. Hence, the distribution of any oasis farming is largely determined by the availability of irrigation water, which is generally most plentiful in the middle reaches of the inland rivers³¹⁴.

With the steadily gained discoveries and research conducted in the last half of the century, many bronze cultures have been confirmed in this area, dating from the 4th to 3rd millennia B. P. . In addition to the Qijia culture, Xindian culture, Kayue culture, Siba culture, Siwa culture, and Shajing culture that have been mentioned by Pak Y. J.³¹⁵, the Nuomuhong culture and Tangwang-style pottery will be discussed in particular. The relations between these cultures are intricate and complicated.

³¹⁴ Pak Y. J. 1996, 259.

³¹⁵ Pak Y. J. 1996, 258-326.

3.1 Qijia culture

3.1.1 Distribution

The Qijia culture is widely distributed in the Qinghai and Gansu Provinces. It reached the upper section of the Jinghe in the east³¹⁶, the Bailongjiang valley in the south³¹⁷, Alashanzuoqi in Inner Mongolia in the north³¹⁸, the Huangshui valley in the northeast of Qinghai and the Shulehe valley in the Gansu Corridor (Hexi Corridor) in the west³¹⁹. About 430 sites of the Qijia culture³²⁰ were confirmed, located mainly in the west of the Hehuang valley and its tributaries (Map 7). Among them, Huangniangniangtai³²¹, Dahezhuang³²², Qinwenjia³²³, Zhangjiazui³²⁴, Jijiachuan³²⁵, Qijiaping³²⁶ in Guanghe, Xiping³²⁷, Xinglin³²⁸, Qiao³²⁹ and Fujiamen³³⁰ in the Gansu Province, Liuwan³³¹, Gamatai³³², Zongzhai³³³, Huangjiashai³³⁴, Shenna³³⁵ and Zongri³³⁶ in the Qinghai Province, and Xinglong³³⁷ town at Xijie, and the Haijiawan town³³⁸ at Guyuan in Ningxia were officially excavated.

3.1.2 Chronology and periodization

The Qijia culture is characterized by pots with flat bottom, constricted neck, flared mouth, and two large vertical loop handles running from the rim to the shoulder. Similar pots with single or double small handles were also found in large numbers. Basket motifs, cord marks, and incised designs were very common. In contrast, the painted potteries were seen occasionally. According to the research on the archaeological remains, especially the potteries, scholars have different opinions about the classification and periodization of the Qijia culture. Xie Ruiju puts forward that the eastern Qijia culture is earlier than the western Qijia culture³³⁹. In addition, he

³¹⁶ PLB 1982.

³¹⁷ CJ 1978, 26-34.

³¹⁸ Qi Y. H. 1962, 22-30.

³¹⁹ Zhang X. Z. 1960.

³²⁰ DTJQH 1996.

³²¹ GSB 1978, 421-447.

³²² ZKKG 1974, 29-62.

³²³ Xie R. J. 1975, 57-96.

³²⁴ Xie R. J. 1980b, 187-220.

³²⁵ Xie R. J. 1980b, 187-220.

³²⁶ GSB 1979, 139-153.

³²⁷ GSB 1979, 139-153.

³²⁸ Yang Y. M. 1985, 977-979.

³²⁹ GSB 1980, 22-24.

³³⁰ Zhao X. 1995, 289-297.

³³¹ Liuwan 84.

³³² QHWK 1979, 160-167.

³³³ QHWD 1986c, 306-317.

³³⁴ QHY et al. 1994, 193-205.

³³⁵ Wang G. D. 1995, 260-261.

³³⁶ Ge/Chen 1999; QHW et al. 1998, 1-14.

³³⁷ Zhong/Zhang 1964, 232-233.

³³⁸ NXZ 1973, 290-291.

³³⁹ Xie R. J. 1979, 60-67.

divides the Qijia culture into four stages³⁴⁰. However, Hu Qianying holds the view that the Qijia culture should be divided into two types: the first type is represented by the Qinweijia and Dahezhuang sites; the second is represented by the Huangniangniangtai and Liuwan sites; the former is earlier than the latter³⁴¹. Other scholars such as Zhang Zhongpei propose a detailed chronology with three periods and eight stages for the Qijia culture, based on his study of stratigraphical data and typological analysis of pottery vessels from the Huangniangniangtai, Qinwenjia and Dahezhuang sites.³⁴² Shui Tao establishes an internal periodization of the various Qijia sites in light of the research on the typology of the potteries and stratigraphical evidence and divides the Qijia culture into four periods and six stages³⁴³(Fig. 099a). This opinion has been largely accepted so far. Another young scholar, Zhang Wenli divided the Qijia culture into three stages and considered that a Post-Qijia culture also existed, accordingly the Qijia culture should end much later than previously expected³⁴⁴.

It is worth mentioning that one French scholar, Debaine-Francfort has undertaken a systematic research on the Qijia culture³⁴⁵. She collected most of the available radiocarbon dates of the Qijia culture (Appendix). The majority of the radiocarbon dates fall into the late third and the first half of the second millennia BCE. Furthermore, it is largely agreed that the relative placement of the Qijia culture is later than the Majiayao culture and earlier than the Xindian, Kayue and Siwa cultures. Both of the chronologies are reconcilable. Accordingly, the Qijia culture falls approximately between 2300-1800 BCE (Appendix).

3.1.3 Copper and bronze

The emergence of copper and bronze objects marks a significant cultural achievement for the Qijia culture. So far, over 130 metal items have been identified. In this respect, previous research has mainly focused on the constituents and metallurgical technology used, in order to find out the metallurgical stage of the Qijia culture against the background of the whole Chinese Bronze Age. Few scholars noted the bronze assemblages, archaeological contexts, manufacturing techniques, and distribution of the Qijia culture.

The Qijia culture is famous for its copper objects, not only pieces (forged), but also large implements (cast). Only a few of them are determined as Cu-Sn alloys. For example, all thirteen artifacts from Huangniangniangtai in Wuwei county were made

³⁴⁰ Xie R. J. 1980c, 248-254.

³⁴¹ Hu Q. Y. 1980, 77-82.

³⁴² Zhang Z. P. 1987a, 1-18; 1987b, 153-176.

³⁴³ Shui T. 2001a, 193-327.

³⁴⁴ ZWL 2003.

³⁴⁵ Debaine-Francfort 1995.

of copper. The bronzes found from Qinweijia in Yongjing county and Qijiaping in Guanghe county were made of alloys including lead-bronze, lead-tin-bronze, and tin-bronze. Both casting and forging methods were used in the Qijia culture. Knives and awls were usually made by forging (Table 15. Test results from copper and bronze artifacts found in the Qijia culture of Gansu,)³⁴⁶. These features indicate that copper metallurgy was mature during the Qijia period though the Qijia people had a limited knowledge of alloying.

Site/number of artifacts	Tested artifacts and number	Material and means of testing	Method of manufacture and means of test
Huangniangniangtai Site, 30 artifacts	Bar, H9 (3)	Copper (note 4)	Mold (archaeological observation)
	Awl, style II T13:1	Copper (note 3)	
23 artifacts and slag unearthed from the first three excavations	Knife, style I AT5:249	Copper (note 3)	
	Ring T18 (2)		Piece rolled up (archaeological observation)
7 artifacts found in the fourth excavation	Knife, style I (collected)		Single mold cast (archaeological observation)
	Knife, style II F3		Hammered (archaeological observation)
	Awl, style I T6:3		Hammered (archaeological observation)
	Awl, style I T10:3		Hammered (archaeological observation)
	Awl, style I BT2(2)		Hammered (archaeological observation)
	Awl, style II H9 (3)		Hammered (archaeological observation)
	Chisel T19 (2)		Hammered (archaeological observation)
	Awl 19948	Copper* (note 4)	
	Awl 2281	Copper (note 4)	
	Awl, Gan267	Copper (note 1)	
	Knife, 19946 75.W.X.T.17	Copper (note 1, 2)	Cast (metallographic examination)
	Knife, 19947 75.W.X.T18(3)	Copper (note 1, 2)	
	Awl, (long) 19668	Copper (note 4)	Forged

³⁴⁶ Sun/Han 1977, 75-84.

	75.W.X.T5		(metallographic examination)
	Awl, (short) 19668	Copper (note 4)	
	Awl, 75.W.X.T17 (2)	Copper (note 1)	
	Awl, 19951 75.W.X.T14(3)	Copper (note 2)	
	Awl, 19950 75.W.X. collected	Copper (note 1, 2)	
Qinweijia site, Yongjing County	Awl, T6:2	Lead-tin-bronze (note 2)	Forged (metallographic examination)
8 artifacts	Ax, T72:1	Copper (note 2)	Cast (metallographic examination)
	Ring M99:6	Lead-bronze	Hammered (archaeological observation)
	Ring, M70:2		Hammered (archaeological observation)
	Ornament H4:1	Copper (archaeological observation)	
	Ornament H19:6	Copper (archaeological observation)	
	Bone handle bronze knife, Linxiazhoubo 187	Tin-bronze (note 1, 2)	
	Point, KG3 732 (2):27	Copper* (note 2)	
Dahezhuang site 2 artifacts, Dagger (TF:7) did not test	Copper piece T30:27	Copper (chemical quantitative analysis)	
Qijiaping site, Guanghe county, 2 artifacts	Mirror 75.G.T1 (g.g.p.) M91	Tin-bronze (note 1, 4)	Curvature radius 214±7mm., convex mirror
	AX 75.G.T1.AF1:1	Copper (note 1, 4)	
Xiping site, Guanghe County, 2 artifacts	Sickle, Linxiazhoubo 137	Copper (note 1, 2, 4)	Cast (metallographic examination)
Xinlin site, Minxian County, 2 artifacts	knife	Copper (archaeological report)	Cast (archaeological report)
	Ax	Copper (archaeological report)	Copper (archaeological report)

Table 15. Test results from copper and bronze artifacts found in the Qijia culture of Gansu, Method of testing: note 1, portable radioisotope X-ray fluorescence instrument qualitative analysis; note 2, atomic emission spectrometry qualitative analysis; note 3, spectral semi-quantitative analysis by the Gansu Geology Bureau; note 4, Atomic Absorption Spectrometry; note 5, electron probe micro analysis; *based on the results of the atomic spectrum qualitative analysis and metallographic analysis, the major elements in large or medium amounts in the qualitative analysis were found to be artificially added elements, so the awl (19948) and point (KG3732(2):27) are copper products, not bronze, as indicated in our earlier tests

(adapted from Linduff et al. 2000, 179-181 Table 1)³⁴⁷.

3.1.3.1 Types

The majority of copper and bronze objects from the Qijia culture were obtained by excavation, and a small amount were collected. Some of the objects have been published in detail; others were only mentioned briefly in related reports (Table 16). In total, these bronzes consist of small implements and ornaments (Fig. 099b). So far, no bronze containers have been found.

3.1.3.2 Assemblage, context, metallurgical technique, and social function

In light of Table 17, the Qijia culture bronzes differ in archaeological contexts, types, composition, and metallurgical techniques owing to regional differences (Table 16; Map 8)³⁴⁸.

	Sites	Context (amount)	Implements							Ornaments				Others			
			a	b	c	d	e	f	g	h	i	J	K	J	l	m	n
A	Huangniangnia ngtai (30)	S (18)	6	4	1	2				1						1	
		T (1)		1													
	Zongzhai	T (6)	4	2													
	Dahezhuang	S (2)						1							1		
	Qinweijia	S (3)		1			1						1				
T (3)									2			1					
B	Shenna	U (1)								1							
	Zongri	T (4)								3						1	
	Gamatai	T (49)								*		*		1			
	Xinzhuangping	C (12)	1								5	6					
C	Weijiataizi	C (1)	1														
	Qijiaping	T (1)												1			
		C (2)					1		1								
	Xiping	C (1)	1														
	Xinglin	C (2)	1				1										
	Shangguandi	C (1)	1														

Table 16. Types, amount, archaeological contexts of the copper and bronze objects of the Qijia culture, S-settlement; T- tombs; C-collected; U-unknown; a-knife; b-awl; c-chisel; d-drill; e-axe; f-dagger; g- dagger head; h-loop; i-bracelet; j-bulb; l-ornament; m-strip shaped object; n-dagger-shaped object; * means that the amount of this type is unclear.

<i>Groups</i>	<i>Main</i>	<i>Assemblage</i>	<i>Types</i>	<i>Compisition</i>	Technique
---------------	-------------	-------------------	--------------	--------------------	-----------

³⁴⁷ Sun/Han 1997, 79 Table 1; translated in Linduff et al. 2000, 170-181.

³⁴⁸ Wang Z. 2006, 9-16.

	<i>context</i>				
A	Dwelling place	Implements	Knives, awls, chisels, drills	Cu	Forging, crudely
B	Tomb	Ornaments	Rings, bulbs, mirrors	Cu-Sn, Cu-Pb	Casting
C	Collected	Implements	Knives, axes, sickles, aggers	Cu; Cu-Sn	Casting, advanced.

Table 17. Comparison of three groups of copper and bronze objects from the Qijia culture.

Group A is mainly distributed in the Wuwei region, upper reaches of the Huangshui, and upper reaches of the Taohe, including the Huangniangniangtai, Zongzhai, and Dahezhuang sites. It is worth mentioning that most of the copper and bronze objects were found from dwelling places, including small implements such as knives, awls, drills, and axes as well as a small quantity of ornaments. In contrast, of the 88 tombs in Huangniangniangtai, 82 tombs in Dahezhuang and 10 tombs in Zongzhai, only a total of 4 tombs were found together with copper and bronze objects, which consisted mainly of small implements such as awls and knives. In addition, the tombs buried with copper and bronze objects were almost the same as the other tombs without metal objects in burial furniture and manners. This phenomenon implies that copper and bronze objects were probably buried as daily implements in the same way as the potteries and stone wares, namely, the appearance of metal objects in burials didn't indicate the more personal wealth or higher social status of the owners. Seventeen samples of Group A have been metallurgically examined for their chemical composition. Sixteen are determined as copper, and one is determined as copper-tin-lead alloy. Most of them were very simple and crudely forged. A few of them were cast by using joint molds.

Group B was mainly discovered in the upper reaches of the Yellow River and eastern plateaus of the Qinghai Province, including the Gamatai, Zongri, Shenna, and Qinweijia cemeteries. In contrast to Group A, most of the copper and bronze objects of Group B were found in the burials. They consisted mainly of ornaments such as rings and bulbs as well as a few mirrors and daggers. Nevertheless, the Gamatai cemetery yielded 46 metal objects in 43 tombs. In addition, only 7 tombs in the Qinweijia and Zongri cemeteries were found together with bronzes. It is worth noting that these tombs neither seem to be richer in funeral objects nor higher in rank than the other tombs without metal objects, implying that copper and bronze ornaments were not treated as the symbol of wealth and status. So far, four samples have been metallurgically examined, showing that three artifacts were made of alloy and one was made of copper. The bronze mirror with delicate decorations, found at the

Gamatai site shows cast techniques.

Group C is mainly collected from Daxiahe, in the middle and lower reaches of the Taohe region. Most of these bronzes are small implements, which are more complicated in forms and manufacturing techniques than those in Group A. Some kind of loop-handled knives, socket axes, and mirrors were very common in the Huoshaogou cemetery. According to the periodization of the Qijia culture sites and the corresponding coexisting relations between the potteries and bronzes, Group B and Group C bronzes should have emerged later than Group A (Table 18).

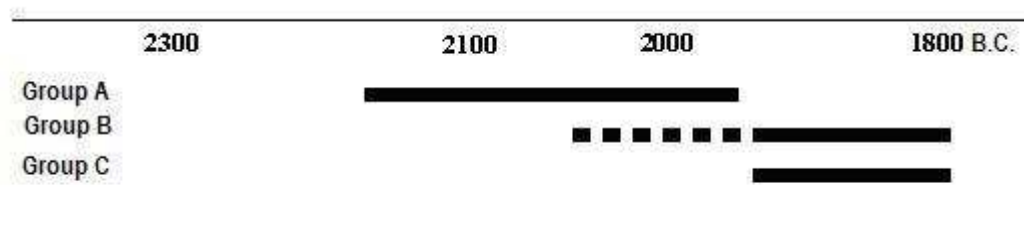


Table 18. Chronology of the bronzes of the Qijia culture.

3.1.4 Origin

There are many diverse opinions regarding the origin of the Qijia culture. Some scholars seek the origin of the Qijia culture in the remains distributed in the eastern region during the Longshan period such as the Lower Changshan culture, Caiyuan culture or Keshengzhuang II culture (Fig. 099c)³⁴⁹. Zhang Zhongpei states that the Qijia culture may have developed from the Xinglongzhen-Xiaqijia complex in the Xiji county of Ningxia³⁵⁰. Other scholars tend to emphasize the indigenous development and highlight the strong cultural continuity in pottery from earlier Neolithic cultures in the same region, especially the Majiayao culture (including the Majiayao, Banshan, and Machang types)³⁵¹. In addition, Zhang Xuezheng suggests that the Machang type lasted much longer than previously thought and was contemporaneous for quite some time with the Qijia culture.³⁵² On the basis of the previously held views, Shui Tao concluded that the main body of the Qijia culture had possibly developed from the Majiayao culture; however, the early Qijia culture absorbed many elements from the Lower Changshan culture and Keshengzhuang culture in the east (Fig. 099c). Most of the hypotheses regarding the origin of the Qijia culture are largely based on the pottery traditions and complexes. Therefore, this study will explore its origin from the copper and bronze artifacts, which will be mentioned in Chapter 6 and Chapter 7.

³⁴⁹ Hu Q. Y. 1980, 77-82; Liang X. P. 1984, 32-40; Zhang Z. P. 1987a, 1987b.

³⁵⁰ Zhang Z. P. 1987a, 1-18; 1987b, 153-176.

³⁵¹ An Z. M. 1992, 319-396; Yan W. M. 1978, 62-76.

³⁵² Zhang X. Z. 1993, 143.

3.2 Siba culture

3.2.1 Distribution

The Siba culture was first recognized at Sibantan, Shandan in 1953 when it was called ‘Siba-style pottery’³⁵³. It was once regarded as a new late Neolithic culture, contemporary with the Qijia culture. After a number of archaeological excavations and surveys were conducted in the western Gansu region, it was finally reconsidered to be one of the early Bronze Age cultures in northwest China³⁵⁴.

The Siba culture was mainly distributed in the middle of the Hexi Corridor, extending to the Wuwei county in the east³⁵⁵, touching the lower reaches of the Heihe Valley in the north³⁵⁶, the middle and upper reaches of the Shulehe valley in the south³⁵⁷, and the Hami basin in the west³⁵⁸. Important sites of the Siba culture include: Huoshaogou³⁵⁹ and Shaguoliang³⁶⁰ in Yumen town, Ganguya³⁶¹ in Jiuquan county, Donghuishan³⁶² in Minle county, Xihuishan and Sibatan in Shandan, Yingwoshu in Anxi county, and so on (Map 12).

3.2.2 Chronology, periodization and origins

As for the periodization of the Siba culture, Li Shuicheng divides it into five stages based mainly on the typological analysis of the Ganguya and Huoshaogou potteries, suggesting that the Huoshaogou cemetery in the western region of the Hexi Corridor is, as a whole, earlier than the Ganguya cemetery in the middle region of the Hexi Corridor. Furthermore, the first Stage is represented by the Sibatan site; the fourth stage is marked by the Shaguoliang site; the fifth stage is represented by the Yingwoshu site³⁶³.

In terms of the reanalysis of the potteries from Huoshaogou, Ganguya, Sibashan, Donghuishan, and Yingwoshu (Fig. 104a), Shui Tao proposes another relative chronology with 3 periods and 7 stages for the major sites of the Siba culture. He suggests that Donghuishan should represent the first period of the Siba culture; Huoshaolao lasts from the first to fifth stage of the Siba culture, earlier than Ganguya; Sibatan and Shaguoliang fall in the middle period; and Yingguoshu was in the late

³⁵³ An Z. M. 1956, 9-11.

³⁵⁴ An Z. M. 1993, 1110-1119; Li S. C. 1993, 80-101; Yan W. M. 36-44.

³⁵⁵ As stated by Shui Tao (2001a, 321), some potteries found at Huangniangniangtai in Wuwei county belonged to the Siba culture.

³⁵⁶ Some painted potteries of the Siba culture were collected from the Heihe valley.

³⁵⁷ A number of sites were recognized as the Siba culture at Yumen town in the Shulehe valley.

³⁵⁸ Some typical elements of the Siba culture have been confirmed at the Hami basin.

³⁵⁹ The materials are yet to be published. Some of them have been mentioned in GSB 1979, 139-153.

³⁶⁰ The materials are yet to be published.

³⁶¹ The materials are yet to be published.

³⁶² Donghuishan 98.

³⁶³ Li S. C. 1993, 80-101.

period³⁶⁴.

Regarding the origin of the Siba culture, both Li Shuicheng and Shui Tao recognize the similarity and continuity in pottery styles from the Machang type, and the Qijia culture to the Siba culture. According to the stratigraphical evidence and pottery comparison, it is acceptable that the Siba culture is relatively later than the early Qijia culture. In addition, Li Shuicheng suggests that the middle and late period of the Siba culture was approximately parallel to the early Kayue culture in view of several potteries found in the Kayue style at Huoshaogou.

So far, only a few radiocarbon dates of the Siba culture are available (Appendix). The four radiocarbon dates from the Huoshaogou site and another four from the Ganguya site are approximately within the same time range, which supports the opinion, held by most Chinese archaeologists that the Siba culture may be dated to 1900-1500 BCE, parallel to the Xia period and early Shang period in the Central Plain³⁶⁵.

3.2.3 Metal objects

As with many other Bronze Age cultures in northern China, most of the information available on the Siba culture is from burials, and metal objects are no exception (Table 3.13). About 300 metal objects have been found, including tools, weapons, and personal ornaments, which are made of copper, bronze, gold, and silver. They include several small copper/bronze knives and earrings unearthed from Sibatan, over 200 pieces of metal objects discovered from Huoshaogou, over 10 metal objects found from Yingshuwo, 2 bronze fragments found from Xihuishan, 16 pieces found from Donghuishan and 48 pieces found from Ganguya. In total, over 270 pieces of metal objects were recognized as belonging to the Siba culture³⁶⁶ (Table 19).

Site	Archaeological context	Copper, bronze, gold and silver objects
Sibatan	Burial, settlement	Bronze/copper knives; gold earring ³⁶⁷
Huoshaogou	Burials (200 pieces) ³⁶⁸	Bronze/copper, gold and silver objects ³⁶⁹
Yingguoshu	Burials ³⁷⁰	Bronze/copper and gold earring, pea-shaped ornaments ³⁷¹

³⁶⁴ Shui T. 2001a, 243-250.

³⁶⁵ Li S. C. 1993, 80-101; Shui T. 2001a, 250.

³⁶⁶ Li/Shui 2000, 36.

³⁶⁷ An Z. M. 1959b, 7-16.

³⁶⁸ A total of 312 tombs were excavated at Huoshaogou. Among them 106 tombs were buried with over 200 pieces of copper and bronze objects.

³⁶⁹ GSB 1979, 139-153.

³⁷⁰ A total of 3 tombs of the Siba culture were excavated, found together with 7 pieces of copper and bronze objects. Furthermore, several bronze objects were collected from the surface.

³⁷¹ Not yet published. According to the research by Li Shuicheng and Shui Tao (2000, 36-44).

Xihuishan	Settlement ³⁷²	Bronze/copper knife, scraper ³⁷³
Donghuishan	Burials, settlement ³⁷⁴	Bronze/copper knife, awl, earring ³⁷⁵
Ganguya	Burials ³⁷⁶	Bronze/copper objects ³⁷⁷

Table 19. Metal objects of the Siba culture.

3.2.3.1 Types

The metal objects of the Siba culture can be divided into three types: tools, weapons and personal ornaments (Fig. 104b), showing close relations with other cultures. Such a straight-handled knife (Fig. 104b, 13.14) is also seen in the Machang type and Qijia culture (Fig. 099b, 2.23). Compared to the metal objects found in the earlier Qijia culture, more compound tools appeared in the Siba culture, such as axes and awls (Fig. 104b, 9-12).

It should be noted that the metal ornaments were not only made of copper and bronze but also of gold and silver, especially earrings and rings. It has been mentioned earlier that one copper pole-top (or mace head) with four projecting ram-heads (Fig. 104b, 34) is very striking in the Siba culture. It is 8cm in height and the ring-base is 2.8cm in diameter. There are four string patterns at the end and four goat heads with coiled horns. This object implies highly developed metallurgical techniques at that time.

Overall, the metal objects display a nomadic style. So far, no bronze vessel have been found in the Siba culture, it is probably because they were not used as funeral goods³⁷⁸.

3.2.3.2 Metallurgical technique

Sixty-six out of over two hundred items found at the Huoshaogou site have been analyzed, showing that 30 are made of copper and the others are made of tin-copper or tin-lead bronze. Except for four samples made by forging, the others are made by casting. The pole-top with four-goat heads displays a complicated metallurgical technique, including the method of using composite molds and a separate mold. In the second metallurgical analysis, a few Cu-As alloys were also identified (Table 10; Table 11).

³⁷² Only two pieces of bronze fragments were found.

³⁷³ Li/Shui 2000, 36-44.

³⁷⁴ A total of 249 tombs were excavated at Donghuishan, found together with 16 pieces of copper and bronze objects.

³⁷⁵ Donghuishan 98.

³⁷⁶ A total of 105 tombs of the Siba culture were discovered at Ganguya, found together with 48 pieces of copper and bronze objects.

³⁷⁷ Li/Shui 1988, 271.

³⁷⁸ Li/Shui 2000, 38.

Sixty-eight items of the bronze objects found at the Donghuishan³⁷⁹ (Table 4; Table 5; Table 6) and Ganguya sites (Table 12; Table 13; Table 14) have been examined by atomic absorption spectrum analysis, scanning electron microscope, and metallurgical structure analysis. The metallurgical analysis of the bronzes found at the Donghuishan site has been discussed in Chapter 2.3.2, so it will not be repeated. As we know, 13 artifacts from the Donghuishan site contain 2%-6% arsenic. Among them, 3 artifacts contain respectively 1.4%, 1.7%, and 8% of tin as well. From Table 12, Table 13 and Table 14, we can see that the arsenic-copper alloys as well as the tin-copper alloys are very popular. In addition, the bronzes at the Yingguoshu site are mostly determined as Cu-Sn alloys³⁸⁰.

Not all of the related bronze information about the Siba culture has been published. Based on the aforementioned research on the periodization of the major sites, the metallurgical development in the Siba culture can be roughly divided into two periods. During the early period of the Siba culture, copper was dominant, especially in the Huoshaogou site where copper occupies 50% of the analyzed samples. It is quite interesting that tools and weapons were made of copper more than of bronze, while ornaments were normally made of bronze. This is hard to explain. Arsenic copper alloy is popular at another early Siba culture site Donghuishan, however, tin copper alloy increases over time at Ganguya. During the late period, tin copper alloy takes the lead at Yingwoshu. The metallurgy of the Siba culture seems to have started from copper, then to arsenic copper alloy, and finally to tin copper alloy, in accordance with that in the Eurasian Steppe. This process differs greatly with the Central Plain, which is characterized by copper-zinc alloy in the early period and copper-tin alloy in the late period. In addition, an anthropology study has suggested that the Gansu-Hexi Corridor area was full of East Asian Mongoloids. No typical Caucasians have been identified in the region at that time³⁸¹.

The Gansu Province was and is one of the major sources of nonferrous deposits in China. The minerals are always distributed around archaeological sites, and ores of copper, tin, lead, and arsenic have been identified. All of the essential materials necessary for the emergence of metallurgy can be found in this region³⁸².

3.3 Xindian culture

3.3.1 Distribution

The Xindian culture, one of the bronze-using cultures in the Qinghai and Gansu

³⁷⁹ The metallurgical technique of the bronzes found from the Donghuishan site has been discussed in Chapter 2.3.2 in detail.

³⁸⁰ Sun/Han 1997, 75-84.

³⁸¹ Han/Pan, 1984, 245-263.

³⁸² Sun/Han 1997, 84.

regions, is distributed mainly along the banks of the Yellow River and its tributaries in middle Gansu, and the Huangshui region in Qinghai (Map 9) and includes nearly a hundred sites³⁸³. It has reached Gangu³⁸⁴ and Zhuanglang³⁸⁵ in the upper reaches of the Weihe in the east, Datong³⁸⁶ and Huzhu³⁸⁷ in the west, Kangle³⁸⁸ in the middle reaches of the Taohe in the south, and Yongdeng³⁸⁹ and Yuzhong³⁹⁰ in the north.

So far, Shanjiatou³⁹¹, Xiaohandi³⁹², Liuwan³⁹³, Jijiachuan and Zhangjiazui³⁹⁴, and Lianhuatai³⁹⁵ have been formally excavated and published. Sporadic finds have been discovered at Bojizhang³⁹⁶, Bianqiang³⁹⁷, Dongdapo, Shanghantai, Erfang³⁹⁸, Zhongchuanshiguala³⁹⁹, Zhuandao⁴⁰⁰, Zongzhai⁴⁰¹, Hetaozhang⁴⁰², Xindian, Sishiding, Huizui⁴⁰³, Heitouzui⁴⁰⁴, Yanchang⁴⁰⁵, Yatou⁴⁰⁶ in Qinghai and Gansu provinces in the survey.

3.3.2 Classification, chronology, periodization, origins and trace

The classification, chronology, periodization, and origin of the Xindian culture are still in dispute. Before the 1980s, the research mostly focused on the classification and the chronological relations between them. There are two main opinions. One opinion divides the Xindian culture into two types: A and B⁴⁰⁷ or Jijiachuan and Zhangjiatui⁴⁰⁸ though the chronology of the two types is still in argument. Another opinion, divides

³⁸³ DTJQH 1996.

³⁸⁴ Shui T. (2001a, 205) put forward that the remains of TM7 from Gansu should be ascribed to the Shanjiatou type of the Xindian culture.

³⁸⁵ Three potteries found from the Zhuanglang county were ascribed to the Jijiachuan type of the Xindian culture; see Nan Y. Q. 1989, 73-109.

³⁸⁶ As noted by Shui T. (2001a, 319), some potteries of the Zhangjiazui type of the Xindian culture were confirmed in the survey at the lower Datonghe region.

³⁸⁷ Zhao/Xie 85.

³⁸⁸ According to the survey report.

³⁸⁹ In the survey at Yongdeng, some potteries of the Zhangjiazui type of the Xindian culture were discovered, however, are not yet published (Shui T. 2001a, 319).

³⁹⁰ Some potteries of the Shanjiatou type of the Xindian culture were identified in Yuzhong, however the related materials is not yet published (Shui T. 2001a, 319).

³⁹¹ QHW 1992, 10-15.

³⁹² QHW 1995, 1-12.

³⁹³ Liuwan 84.

³⁹⁴ Xie R. J. 1980b, 187-220.

³⁹⁵ Xie R. J. 1980a, 296-310.

³⁹⁶ Gao/Wu 1984, 30-33.

³⁹⁷ Hong/Ge 1990, 25-34.

³⁹⁸ QHY 1993, 193-211.

³⁹⁹ Liu X. H. et al. 1982, 18-22.

⁴⁰⁰ He/Gao 1982.

⁴⁰¹ QHWD 1986b, 882-886.

⁴⁰² Over 360 tombs were excavated in Hetaozhuang which is the biggest Xindian culture cemetery so far, while most of the materials have not been published. Chen H. H. (1990) mentioned that the Hetaozhuang cemetery includes the potteries of the second, third and fourth stages of the Lianhuatai cemetery and the first, second and third stages of the Zhangjiazui site.

⁴⁰³ Andersson 1925.

⁴⁰⁴ HHGS 1959, 181-184.

⁴⁰⁵ GSY et al. 1994, 1-15.

⁴⁰⁶ GSBG 1981b, 16-21.

⁴⁰⁷ An Z. M. 1957, 23-31.

⁴⁰⁸ HHGS 1959, 181-184.

the Xindian culture into four successive groups; Tangwang, Zhangjiazui, Sishiding and Xindian.⁴⁰⁹

With more excavation of the Xindian culture sites, scholars tend to emphasize the developing process and origins of the Xindian culture. There are three main ideas. Nan Yuquan divides the Xindian culture into 7 periods and 10 stages according to the materials of the Hetaozhuang and Lianhuatai sites. Furthermore, he insists that the Xindian culture should have originated from the Shanjiatou type of the Qijia culture, as the decoration on earlier potteries resembles those of the Machang type. It was also suggested that the Xindian culture lasted between 1500-600 BCE, approximately, from the Middle Shang to the Early Spring and Autumn Period⁴¹⁰. Zhang Xuezheng states that the Xindian culture which was heavily influenced by the Qijia culture, was developed mainly from the late-Qijia culture, with elements of the Machang type which is especially reflected in painted potteries. In addition, it experienced three stages: Shanjiatou, Jijiachuan, and Zhangjiazui. Furthermore, the Xindian culture was dated from the late Xia period to the late Western Zhou period. The two-eared pots and bowls, ring-based pots and ring-based pots with a single ear can also be seen in the late Qijia culture. Based upon the research on the Shanjiatou cemetery and Xiaohandi cemeteries⁴¹¹, Xu Yongjie divides the Xindian culture of the Qinghai Province into 6 stages and puts forward that the monochromic and polychromic potteries with round base may have respective origins though they coexisted from the beginning to the end of the Xindian culture.⁴¹²

It is worth mentioning that Shui Tao⁴¹³ divides the Xindian culture into 3 periods and 7 stages in light of the analysis of the potteries from different sites and related stratigraphical evidence (Fig. 100a; Fig. 100b). The first stage of Shanjiatou is parallel to the late Qijia culture; accordingly, the second and third stage of Shanjiatou cannot be earlier than the Qijia culture. The Tangwang-style potteries, parallel to the seventh stage of the third period of the Xindian culture, is speculated to have coexisted with the Zhangjiazui type potteries that are ascribed to the fifth and sixth stages of the third period of the Xindian culture. It implies that the former is not so close to the first and second stages of the Shanjiatou type, and the third and fourth stages of the Jijiachuan type. Some Tangwang-style potteries coexisted with the late Kayue culture remains in the Shangsunjiazhai site, Qinghai province, suggesting that the Tangwang-style potteries were relatively later than the other Xindian culture types. Therefore, as far as the relative chronology of the Xindian culture is concerned, it is later than the late

⁴⁰⁹ Yan W. M. 1978, 62-76.

⁴¹⁰ Nan Y. Q. 1989, 73-109.

⁴¹¹ Zhang X. Z. 1993, 122-152.

⁴¹² Xu Y. J. 1993, 166-203.

⁴¹³ Shui T. 2001a, 207-220.

Qijia culture, earlier than the Eastern Zhou culture in the middle Gansu region, and contemporaneous to the late Kayue culture in the east of the Qinghai region⁴¹⁴.

Zhang Wenli divides the Xindian culture in the Qinghai Province into three periods and eight stages⁴¹⁵. His opinion improves Shui Tao's periodization and adds the materials of the Xiaohandi cemetery, Bojizhang, and Shiguala sites (Fig. 100c; Fig. 100d). In light of the potteries, he put the Bojizhang, Bianqiang, and Shiguala into the second period of the Xindian culture, and the first to the fourth stages of the Xiaohandi cemetery into the third period. His periodization will be used in this study.

In addition to the relative chronology of the Xindian culture sites, several radiocarbon dates provide us with a basis for absolute dating (Appendix). Shui Tao ascribes the Maluyuan site to the third stage of the second period of the Xindian culture⁴¹⁶. Considering that the Tangwang-style pottery coexisted with the Kayue culture for a long time, the radiocarbon dates from some Tangwang-style potteries can also be used as a cross reference for the date of the Xindian culture⁴¹⁷. Conclusively, the Xindian culture falls roughly between 1600-600 BCE, parallel from the early Shang to the Spring and Autumn period.

As for the origin of the Xindian culture, the relations between the late or Post-Qijia culture and the early Xindian culture is an unavoidable issue. It has been largely accepted amongst scholars that the Xindian culture probably originated from the Qijia culture, also adopting some elements of the Machang type⁴¹⁸.

As far as the offspring of the Xindian culture is concerned, Yu Weichao⁴¹⁹ and Nan Yuquan⁴²⁰ observe some similarities between the late Xindian culture and the early Shajing culture. While Zhang Xuezheng points out that the decline of the Xindian culture is probably related to the rise of the Kayue culture⁴²¹.

3.3.3 Comparing the Xindian culture between the Qinghai and Gansu regions

In light of Yu Weichao's opinion, the Xindian culture can be divided into Taohe and Huangshui types⁴²². There are no big differences between the pottery assemblage of the Xindian culture in the Qinghai and Gansu Provinces, but minor differences in the quantity of different kinds of potteries. For example, the painted bowls with a handle,

⁴¹⁴ Shui T. 2001a, 219-220.

⁴¹⁵ ZW L 2003, 17-23.

⁴¹⁶ Shui T. 2001a, 220.

⁴¹⁷ It will be discussed later.

⁴¹⁸ Yu. W. C. 1985a, 193-210.

⁴¹⁹ Yu W. C. 1985a, 193-210.

⁴²⁰ Nan Y. Q. 1989, 73-109.

⁴²¹ Zhang X. Z. 1993, 122-152.

⁴²² Yu W. C. 1985a, 193-210.

painted pots with two ears and tripods-Li are rarely seen in the Qinghai Province but are commonly found in the Gansu Province.

However, greater differences can be observed in the burial manners between the two provinces. In the Qinghai Province, the deceased were mostly laid out in an extended position in a coffin, or a coffin with an outer coffin; a few of them were buried in an earth pit as well as in a one-sided shaft pit and sarcophagus. The secondary burial was also particularly popular⁴²³ and may have been passed over from the previous ancient cultures in the Qinghai Province. By contrast, the burial manners of the Xindian culture in the Gansu Province were much simpler. The deceased were normally placed in an extended position in an earth pit without a coffin. Nevertheless, in contrast to the differences between the Qinghai and Gansu Provinces, the differences in the Xindian culture are less.

3.3.4 Bronze

Only a small quantity of bronze objects from the Xindian culture were discovered, including awls, axes, arrowheads, bulbs, tubes, buttons and so on (Fig. 100e). One bronze Guan-vessel discovered at Lianhuatai, was quite similar to the most common pottery of the Xindian culture. Few of the bronze objects of the Xindian culture have been metallurgically analyzed, so it is hard to tell how the metallurgical techniques developed in the Xindian culture. However, based on the available analysis and archaeological observation, all of them have been determined as bronze with varying degrees of tin and other metallic components. The bronze objects found at the settlement consisted mainly of weapons and implements. In contrast, the bronzes found in the burials are mainly personal ornaments.

Site	Context	Bronze items
Zhangjiazui	Settlement	1 spear head, 1 fragment, 2 pieces of slag
Lianhuatai	Settlement	1 knife, 2 awls, 3 buttons, 1 spatula
Lianhuatai	Burials	1 Guan pot, 2 buttons, 14 tubes
Yatou	Burials	Rust
Shanjiatou	Burials	1 belt hook
Tuyangtou	Collected	1 axe; 1 awl
Shuangerdongping	Collected	1 arrowhead

Table 20. Bronze objects of the Xindian culture.

⁴²³ Secondary burials were very common in the Shangsunjiazhai cemetery.

3.4 Kayue culture

3.4.1 Distribution

The Kayue⁴²⁴ culture is one significant Bronze Age culture in northwest China, mainly distributed in the Qinghai Province⁴²⁵. It reached the borders of the Gansu and Qinghai provinces in the east, the Xinhai and Tongde counties in the west, the Datonghe valley in the north, and Zeku in the Huangnanzhou county in the south. The regions along the Yellow River and the Huangshui valley are the central areas of the Kayue culture (Map 10).

So far, over 1700 sites have been identified as belonging to the Kayue culture⁴²⁶. Of them, the Shangsunjiashai cemetery⁴²⁷ and Huangjiashai cemetery⁴²⁸ in Datong county, Panjialiang cemetery in Huangzhong county⁴²⁹, Dahuazhongzhuang cemetery⁴³⁰, Luanshan and Huabiliang villages⁴³¹, Gangcha cemetery⁴³², Momula cemetery⁴³³, Ahatela cemetery⁴³⁴, Suhusa cemetery⁴³⁵, Shangbanzhuwa cemetery⁴³⁶, Xiabanzhuwa cemetery⁴³⁷ and Shanpingtai cemetery⁴³⁸ have been formally excavated.

J. G. Andersson first identified its unique pottery assemblage at the Kayue site in Huangyuan county, Qinghai Province in 1923-1924⁴³⁹. It was until the 1950s that the Kayue culture was finally distinguished from the Siwa culture. After the 1970s, more research on the Kayue culture was carried out.

3.4.2 Chronology, periodization and origin

There are different opinions on the chronology, periodization, and origin of the Kayue culture since the designation was put forward in the 1950s.

Yu Weichao states that the Kayue culture originated from the Qijia culture, and then developed into two subtypes: Ahatela and Shangsunjiashai. Furthermore, he divides

⁴²⁴ It was once translated as Kayao where the remains of this culture were firstly discovered.

⁴²⁵ An Zhimn states that some sites along the Yellow River in Yongjing county, Gansu Province have been confirmed as the Kayue culture (An Z. M. 1956, 9-19). Shui Tao once pointed out that some typical Kayue culture potteries-long necked pots with ears in their abdomen were found in the Huoshaogou site, Yumen county, Gansu Province, however, the related pictures have not been published.

⁴²⁶ DTJQH 1996.

⁴²⁷ Xu/Ge 1988, 35-44.

⁴²⁸ QHY et al. 1994, 193-205.

⁴²⁹ QHY 1994b, 28-97.

⁴³⁰ QHHYB 1985b, 11-34.

⁴³¹ QHWD 1986b, 882-886.

⁴³² Wang W. 1990, 15-21.

⁴³³ Gao/Xu 1990, 1012-1016.

⁴³⁴ Xu/Ge 1988, 35-44.

⁴³⁵ QHK 1994, 425-469.

⁴³⁶ QHY et al. 1996, 27-44.

⁴³⁷ Liu/Dou 1998, 3-11.

⁴³⁸ QHWD et al. 1987, 255-273.

⁴³⁹ Andersson 1925, 18; 1943, 185-197.

the Kayue culture into four periods, roughly parallel from the late Xia period to the end of Shang period and the beginning of the Zhou period⁴⁴⁰.

Zhang Xuezheng holds the opinion that the Kayue culture experienced two successive stages: the Kayue stage and Shangsunjiashai stage (including Tangwang-style potteries). In addition, the Kayue culture and the Siba culture belonged to the same cultural system, dating roughly to the Shang and Zhou period⁴⁴¹.

Xu Yongjie divides the Kayue culture into 3 periods and 6 stages. Meanwhile he puts forward that Shangsunjiashai and Suhasa, two sub-types of the Kayue culture, have their own origins. The former perhaps originated from the Machang type and absorbed certain elements from the Huangshui type of the Qijia culture as well; the latter was considerably related to the Huangshui type of the Qijia culture and absorbed certain elements from the Machang type and the Xindian culture⁴⁴².

This study believes that the Kayue culture originated from the late Qijia culture because most of the earliest potteries of the Kayue culture can be traced to the potteries of the late Qijia culture (Fig. 101c). Besides, it absorbed elements of the Machang type and had a close relationship with the Tangwang-style potteries as well as the Siba culture.

On the basis of the typological research on potteries found at Ahatela⁴⁴³, Kayue, Xiaxihe, Panjialiang, Shangbanzhuwa, Xiabanzhuwa, Shanpingtai, Dahuazhongzhuang, Huangjiashai, Shui Tao divides the Kayue culture into two regions, namely the Huangshui valley and the Yellow River region, as well as 3 periods and 6 stages (Fig. 101a; Fig. 101b). In contrast, the painted potteries found in the Yellow River region are more advanced than those found in the Huangshui Valley. However, the type in the Huangshui valley developed parallel to that of the Yellow River region. Finally, both of them converged gradually. Fewer Li-tripods were found in the burials, in contrast more were found in settlements of the Kayue culture. Furthermore, the rise, development, and decline of the Tangwang-style potteries seem to be connected to the late stage of the Kayue culture.

Some stratigraphical evidence provides crucial clues for the relative chronology of the Kayue culture. The remains of the Kayue culture often overlies on those of the Majiayao type or the Qijia culture, indicating their relative dates. At Shangsunjiashai,

⁴⁴⁰ Yu W. C. 1985a, 166-203.

⁴⁴¹ Zhang X. Z. 1988, 38-41.

⁴⁴² Xu Y. J. 1993, 166-203.

⁴⁴³ The materials of the Ahatela cemetery have not been published though a total of 217 Kayue culture tombs were found. The information is only mentioned in some research articles.

tombs of the Kayue culture were overlain with Tangwang-style potteries. Therefore, the Kayue culture is later than the Qijia culture and slightly earlier than the Tangwang-style potteries. Combined with the available radiocarbon dates (Appendix), the Kayue culture falls mainly between 1600-600 BCE, parallel from the early Shang period to the Eastern Zhou period.

3.4.3 Bronzes

Since most of the Kayue culture sites were found together with bronzes, the Kayue culture has the most bronze artifacts of any bronze culture in the Qinghai Province, in both quantity and variety. Including as-of-yet unpublished material, Liu Baoshan speculates that over 1000 bronzes are identified as belonging to the Kayue culture⁴⁴⁴. In addition to the unpublished copper and bronze objects, a part of them were stray finds and another part of them were published but without the information of coexisting contexts.

It is worth mentioning that a Japanese scholar, Miyake Toshihiko, made a primary research on the bronzes from the Kayue culture. He mentioned that the bronze-making technology in the Huangshui region was more advanced than that in the Yellow River valley by comparison, and that the sexual differences of the tomb-owners are reflected in the distinction of the funeral objects⁴⁴⁵.

On the basis of the research by Miyake and Zhang Wenli⁴⁴⁶ and the relative chronology gained by the potteries, this study will try to make a tentative periodization and systematic analysis on all of the published bronzes in light of the typological research (Fig. 101d).

Taking into consideration the fact that there are too many bronze objects, the discussion about how to date them will not be described one by one in detail. The bronze objects whose ascription is still controversial will be the emphasis.

3.4.3.1 Classification and periodization

The bronzes of the Kayue culture consist of containers, weapons, tools, daily wares, ornaments and so on including cooking ware-Li, battle axe-Yue, axes, spears, swords, dagger axes-Ge, arrowheads, knives, helmets, chisels, awls, mirrors, bells, hairpins, bracelets, earrings, bulbs, joined beads, pole tops and so on. The distribution of each kind of bronze differs in the amount and period between the Huangshui and Yellow River valley (Table 21; Table 22).

⁴⁴⁴ Liu B. S. 1996b, 75-77.

⁴⁴⁵ Miyake Toshihiko 2005, 73-88.

⁴⁴⁶ ZWL 2003, 52-76.

type		Huangshui valley										
		Yue	spear	axe	chisel	knife	tu be	bulb	bell	Joined bead	Pole- top	mirr or
I	1	√				√	√	√	√			
	2		√	√		√	√	√	√			
II	3			√	√	√	√	√	√	√		√
	4				√			√	√	√		√
III	5		√			√	√	√	√		√	
	6		√			√	√	√	√		√	

Table 21. Periodization of the bronzes of the Kayue culture in the Huangshui valley (adapted from Miyake Toshihiko 2005, 73 Table 1).

type		Yellow River valley										
		Yue	spear	axe	chisel	knife	tube	bulb	bell	Joined bead	Pole- top	mirror
I	1											
	2					√		√				
II	3					√		√		√		
	4											
III	5				√	√		√	√			
	6							√				

Table 22. Periodization of the bronzes of the Kayue culture in the Yellow River valley (adapted from Miyake Toshihiko 2005, 74 Table 2).

3.4.3.1.1 Container

So far, several bronze containers were ascribed to the Kayue culture. One bronze cooking ware-Li discovered at the Baojiazhai site, near Xining (Fig. 101d, 1)⁴⁴⁷ is worth noting. Li Xueqin considered that it resembled the Li found from the Erligang site⁴⁴⁸ which is a typical early Shang site in the Central Plain. Another bronze Gui-vessel (Fig. 101d, 2), collected from the Dahuazhongzhuang site⁴⁴⁹ with the Chinese characters '史? 乍朕皇考商中王女季? 宝? ? 其万年子孙永保用' on the base⁴⁵⁰, is dated from the late Western Zhou period to the early Spring-Autumn Period. Both of them were very common in the Central Plain. Liu Baoshan⁴⁵¹ ascribes some bronze

⁴⁴⁷ According to the coexisting objects, it was ascribed to the Kayue culture. See Zhao S. C. 1995, 635 Fig. 1.

⁴⁴⁸ Li X. Q. 1989, 122-132.

⁴⁴⁹ ZWL 2003, 55.

⁴⁵⁰ Some scholars considered it as an imitation.

⁴⁵¹ Liu B. S. 1996a, 115-118.

jars, boxes, and bowls to the Kayue culture⁴⁵².

3.4.3.1.2 Weapon

Quite a large quantity of weapons were found in the Kayue culture, including a socket battle axe, battle axe-Yue, dagger axe-Ge, spears swords, arrowheads and so on (Fig. 101d, 3-40).

According to Fig. 101d, axes and Yue were more common than the other weapons during the Shang and Western Zhou period (Fig. 101d, 3-19). However, after the Spring-Autumn period, bronze spears were becoming more prevalent (Fig. 101d, 24-30). So far, only two short swords (Fig. 101d, 31.32) have been identified in the Kayue culture, which are suitable for fighting at a short distance. In contrast, bronze axes, battle axes-Yue, battle daggers-Ge, and spears applied to longer-distance fighting.

It is worth mentioning that the cultural ascription of the bronze spear with a barb between the body and the hilt (Fig. 101d, 24), which was found at the Shenna site, near Xining⁴⁵³ should be questioned. In previous research, most of the Chinese and foreign scholars ascribed it to the Qijia culture⁴⁵⁴ as well as comparing it to similar spears found from outside China, especially in the south of Siberia⁴⁵⁵ (Fig. 102). The original report regarding this spear says ‘the Qijia culture is the major cultural element of this site as well as a few of the Han remains.... There are 13 groups of superimposing relations. In light of the stratigraphical evidence, this site can be divided into two periods. This spear is discovered from one trash pit of the late period’⁴⁵⁶. However, detailed information is not provided. Li Shuicheng noticed that this spear was marked as ‘the Qijia and Kayue culture’ in one exhibition several years ago⁴⁵⁷. Are there any Kayue culture remains at Shenna? If there are, why are they not mentioned in the earliest report by the excavators? What does ‘one trash pit of the late period’ mean? How late is ‘the late period’? – Li Shuicheng questioned the traditional opinions of this special spear⁴⁵⁸.

If we review the metal assemblage of the Qijia culture (Fig. 099b), most of the copper and bronze objects are very simple in form. In addition, there are not any objects with a tubular handle. The alloying knowledge of the Qijia people was still limited. By comparison, there are a considerable number of bronze objects with a tubular handle

⁴⁵² See Liu B. S. 1996a, 115-118. However, the author has not provided the pictures of these bronze vessels

⁴⁵³ Wang G. D. 1995, 260-261.

⁴⁵⁴ Wang G. D. 1995, 260-261; MJJ 2006, 11-23; Wagner 2001, 37-56 and so on.

⁴⁵⁵ MJJ 2001, 17 Fig. 3.

⁴⁵⁶ Wang G. D. 1995, 260-261.

⁴⁵⁷ Li S. C. 2005, 239-277.

⁴⁵⁸ Li S. C. 2005, 239-277.

in the Kayue culture, such as axes (Fig. 101d, 3-10), daggers (Fig. 101d, 22-23), and so on. Therefore, it seems more logical if we ascribe this bronze spear to the Kayue culture instead of the Qijia culture. In addition, it is 61.5 centimeters long and 10 centimeters wide (Fig. 101d, 24). No trace of any usage has been observed. It may have been produced as a special burial good rather than a weapon.

3.3.4.1.3 Tools, ornaments and others

The bronze tools of the Kayue culture include axes, knives, scrapers, chisels, awls, tubes and so on (Fig. 101d, 43-76). Regarding the function of some tubes (Fig. 101d, 64-76), this study prefers to believe that they were used as ornaments.

Ornaments constituted most of the artifacts in terms of quantity and variety, including bells, plaques, bulbs, joined beads, bracelets, armllets, hairpins, rings, earrings, animal and human figures and so on (Fig. 101d, 77-164), that were probably attached to clothing. In addition, more bronzes belonging to the Kayue culture were found in burials, which differ to the Qijia and Xindian cultures.

3.4.3.2 Cultural elements

Based on Table 21, Table 22 and Fig. 101d which has collected as many bronzes as possible belonging to the Kayue culture, it can be inferred that axes, Yue and daggers were much more popular in the earlier period. However, axes, pole-tops, and ornaments were in a growing tendency in the later period.

As for the cultural elements shown in the bronzes of the Kayue culture, Yu Weichao holds the view that the dagger axe-Yue (Fig. 101d, 11) of the Kayue culture was obviously influenced by the Central Plain; some kinds of the bronze knives were similar to those found from the center north.⁴⁵⁹ Lin Yun states that the bronzes found in the west of the Great Wall regions were influenced by both the Central Plain and North-central Complex, from the Shang period to the Spring and Autumn period. Furthermore, he believes that the west region might have had its own metallurgical foundry industry⁴⁶⁰. While Mei Jianjun puts forward that the interactive connections between the cultures of the Ganqing and Xinjiang regions started from the end of the second millennia BCE and the beginning of the first millennia BCE, which is especially reflected in the Nianbulake and the Kayue cultures. Meanwhile, the origin of the Kayue culture can be traced back to the eastern Xinjiang region⁴⁶¹ as well as the Mongolia region⁴⁶².

⁴⁵⁹ Yu W. C. 1985a, 222.

⁴⁶⁰ Lin Y. 2003, 95-145.

⁴⁶¹ Some knives, tubes, beads, bells and ornaments.

⁴⁶² MJJ 2000.

Scholars represented by Miyake Toshihiko⁴⁶³ and Zhang Wenli⁴⁶⁴ suggest that the bronzes of the Kayue culture possess at least three cultural elements: the native element, the element from the Central Plain and the element from the North-central Complex. The native element is manifested not only in forms such as axes (Fig. 101d, 8-10.13), spears (Fig. 101d, 26), chisels (Fig. 101d, 59-61), bells (Fig. 101d, 29-86), plaques (Fig. 101d, 103.104), pole-tops (Fig. 101d, 157.160.161), earrings (Fig. 101d, 155.156), and figures (Fig. 101d, 159), but also in decoration, that are mostly plain. A few of them are decorated with simple patterns, such as decorations on the rim or a pattern with '丁'. In addition, hollowed-out technology was highly developed and was frequently used in bells. Though no chariots or harness have been identified so far, some scholars suggested that these bells probably belonged to chariot fittings. Since the bells were mostly discovered at the waist or joint position of the deceased, they were more like personal ornaments.

Some bronze tripod cooking wares-Li and Gui (Fig. 101d, 1.2), axes (Fig. 101d, 17.19), dagger axes (Fig. 101d, 20), knives (Fig. 101d, 53), arrowheads (Fig. 101d, 36), mirrors (Fig. 101d, 41.42) and bells (Fig. 101d, 77, 78, 97, 99) show great similarities to those from the Central Plain. It is hard to tell whether they were imported from the Central Plain or imitated by the local people.

Other bronze axes (Fig. 101d, 5-7.15.16.18), spears (Fig. 101d, 21.22.24), knives (Fig. 101d, 46.50.51.52.58), arrowheads (Fig. 101d, 32.38.39), bells (Fig. 101d, 95.96.98.100-102), bulbs (Fig. 101d, 141.142), beads (Fig. 101d, 143-150), armllets (Fig. 101d, 112.113), hairpins (Fig. 101d, 111.117.118) and pole-tops (Fig. 101d, 163) resemble typical Northern bronzes. Besides, some bronze axes (Fig. 101d, 11.12), spears⁴⁶⁵ (Fig. 101d, 24) and bulbs (Fig. 101d, 138) show a certain similarity to those from northern Eurasia.

In light of bronze information, the Kayue culture seems to have had more contact with the Central Plain than with northern China in the earlier period; and it had closer contact with northern China than with the Central Plain in the later period.

3.4.3.3 Metallurgical technique

So far, neither smelting and casting sites nor molds have been found in the Kayue culture. Based on archeological observation of these bronzes, it is possible that the local people manufactured some of the bronzes by themselves, despite the fact that most of them may have been imported from the Central Plain and the neighboring regions.

⁴⁶³ Miyake Toshihiko 2005, 73-88.

⁴⁶⁴ ZWL 2003, 52-76.

⁴⁶⁵ It has been discussed in the preceding paragraph.

So far, few of these bronzes have been scientifically examined. For this reason, this study cannot provide the precise information on the metallurgical techniques used in the Kayue culture. However, according to the observation on some samples, we can see that most of them were made of Cu-As alloys except for some axes unearthed from the Shangsunjiashai cemetery (Fig. 101d, 17.19) which were probably made of copper. Two kinds of bronze-making techniques may have been used: cold forging and mold casting. The former was usually used for the battle-axe (Fig. 101d, 4); the later can be observed from the axes found in the Panjialiang cemetery (Fig. 101d, 44.45.48.49).

Compared to the earlier bronze cultures in northwest China, such as the Qijia and Siba cultures, the bronze artifacts of the Kayue culture increased not only in amount but also in types and forms. When compared to the contemporaneous Xindian and Siwa cultures distributed in the east, the Kayue culture had more developed metallurgy as well.

3.5 Siwa culture

3.5.1 Distribution

The Siwa culture, named after the Siwashan cemetery in the Lintao county, excavated by J. D. Andersson⁴⁶⁶, is another Bronze Age culture in northwest China. It was distributed mainly in the middle and southeast of the Gansu province. It extends to the middle and upper reaches of the Taohe in the west⁴⁶⁷, Lanzhou⁴⁶⁸, Huining county⁴⁶⁹ and Qingyang county in the north⁴⁷⁰, the Bailongjiang valley in the south⁴⁷¹, and the east foot of the Ziwulin in the east⁴⁷² (Map 11).

The sites of the Siwa culture are represented by Siwashan⁴⁷³ in Lintao county, An'guo town⁴⁷⁴ in Pingliang county, Liujia village⁴⁷⁵ in Zhuanglang; Xujianian⁴⁷⁶, Lanqiao⁴⁷⁷ in Xihe county, and Jiuzhan⁴⁷⁸ in Heshui county. In general, the sites of the Xindian

⁴⁶⁶ Andersson 1925, 18; 1943, 178-185.

⁴⁶⁷ Some remains of the Siwa culture have been identified at Zhuomi county and Linyuan county, which are the farthest sites so far. (Shui T. 2001a, 220.320).

⁴⁶⁸ Some remains of the Siwa culture have been discovered at Yuzhong in the survey of the Huining. They are absent in the north of the Yellow River (Shui T. 2001a, 220.320).

⁴⁶⁹ Some remains of the Siwa culture have been identified at Jingning county. However, they are absent in the region between the Huining county and Xijie county (Shui T. 2001a, 200.320).

⁴⁷⁰ The remains of the Siwa culture were mainly found at the south of the Xifeng town in Qingzang county.

⁴⁷¹ Zhao/Si 1993, 8-16.

⁴⁷² The Heshui site and Shiqiao site are located in the western foot of the Ziwulin site.

⁴⁷³ Andersson 1943, 1-304; Xia N. 2000, 269-310.

⁴⁷⁴ Zhang X. Z. 1960.

⁴⁷⁵ GSB 1963, 48.

⁴⁷⁶ ZSKKJ 1982, 584-590.

⁴⁷⁷ GSG et al. 1987, 678-691.

⁴⁷⁸ Wang/Shui 1997, 300-460.

culture are located across an area bordering the Xindian culture to the west and north (Map 9; Map 11) and the pre-Zhou and Western Zhou culture to the east.

3.5.2 Chronology, periodization and origin

Based on the stratigraphical evidence and comparison of the potteries, especially those found from the 13 tombs at Siwashan, 104 graves at Xujianian⁴⁷⁹, 9 tombs at Lanqiao, and over 80 tombs at Jiuzhan, Shui Tao points out that differences shown between these sites are due to the stage difference rather than the regional difference. Furthermore, he divides the Siwa culture into 3 periods and 6 stages⁴⁸⁰(Fig. 103a). Besides, some potteries in the first stage of the Jiuzhan site, namely the fourth stage of the Siwa culture (Fig. 103a) coexisted with some typical Pre-Zhou potteries. In addition, some potteries with the Eastern Zhou style were found in the third stage of the Jiuzhan site, which is the sixth stage of the Siwa culture. Therefore, the late period of the Siwa culture was approximately parallel from the late Pre-Zhou or early Western Zhou period to the early Spring and Autumn period.

It is worth mentioning that the Siwa culture maintained a close relationship with the Xindian culture. In the middle and lower reaches of the Taohe, remains of the early Xindian culture and the Siwa culture were found. As stated by Shui Tao, the two cultures may have shared many common features in their early periods, and probably had the same origin⁴⁸¹. In the middle phase of the Siwa culture, the Xindian culture existed to its west. At the same time, the close connections with the Pre-Zhou and Zhou cultures to the east can be observed in the potteries. The eastern expansion of the Siwa culture may have coincided with the western expansion of the Xindian culture⁴⁸².

As for the absolute date of the Siwa culture, only a number of radiocarbon dates are available (Appendix). Considering the relative chronology mentioned above, the Siwa culture falls mainly between 1400-600 BCE, approximately from the late Shang period to the late Spring and Autumn period.

3.5.3 Bronzes

The bronze metallurgy of the Siwa culture is not well known. Most of the bronze objects have been unearthed from burials (Table 23). When comparing the quantities of bronzes found in the burials, they did not seem to be generally and widely used as funeral goods. They were mostly weapons, tools and personal ornaments, including dagger axes, spears, arrowheads, knives, bells, disks, bracelets, buttons, and so on

⁴⁷⁹ Most information on the 104 tombs is not yet published. Some were mentioned in ZSKKJ 1982, 584-590.

⁴⁸⁰ Shui T. 2001a, 220-229.

⁴⁸¹ Shui T. 2001b, 110-114.

⁴⁸² Shui T. 2001b, 110-114.

(Fig. 103b). Evidence of local bronze production is yet to be discovered. In addition, it is suggested that some of the Siwa culture bronzes are similar to those of the Western Zhou culture. So far, no bronze vessels have been found.

Site	Archaeological context (amount)	Bronze items
Siwashan	Burials (13 tombs)	1 bracelet
Xujianian	Burials (104 tombs)	Dagger axe, spears, daggers, arrowhead, knives, bells, buttons, bracelets
Lanqiao	Burials (9 tombs)	2 buttons, 1 dagger axe,
Jiuzhan	Burials (>80 tombs)	52 pieces, including daggers, sword, knives, buttons, tubes, bracelets

Table 23. Copper and bronze objects of the Siwa culture.

3.6 Shajing culture

3.6.1 Distribution

From 1923-1924, the Shajing culture was first identified by J. G. Andersson at Shajing, in Minqin county, Gansu Province⁴⁸³. Its related research was not continued until the 1970s because the archaeological field work was quite difficult to carry out in the desert. So far, the Shajing culture have been identified at Shajing⁴⁸⁴ in Minqin county, Sanjiaocheng, Hamadun⁴⁸⁵, Xigang and Chaiwanggang⁴⁸⁶ in Yongchang county, and Yushugou in Yongdeng county⁴⁸⁷. Its distribution extends roughly to Lanzhou and Jingtai in the east, the center of the desert in the north, the Qilianshan in the south and the Zhangye county in the west (Map 13).

3.6.2 Chronology and periodization

The report on the excavation at Xigang and Chaiwangang⁴⁸⁸ is newly published, providing elaborate information on the mortuary practices and funeral objects of the Shajing culture, thus filling in a gap on the research of the Shajing culture. The excavators divide the Xigang and Chaiwangang cemeteries into two periods and five stages based on the pottery complex and stratigraphical evidence (Fig. 105b). Meanwhile, a periodization research of the Shajing, Sanjiaocheng and Hamadun sites has been made by Shui Tao⁴⁸⁹ (Fig. 105a). The ascription of the Chaiwangang site to the second period of the Shajing culture proposed by Shui Tao, is not in conflict with

⁴⁸³ Andersson 1925, 18-19; 1943, 197-215.

⁴⁸⁴ Andersson 1925, 18-19. GSY 1990, 205-236; GSBG et al. 1984, 598-601.

⁴⁸⁵ GSY 1990, 205-236; GSBG et al. 1984, 598-601.

⁴⁸⁶ Xigangchaiwangang 2001.

⁴⁸⁷ GSBG 1981, 34-36.

⁴⁸⁸ Xigangchaiwangang 2001.

⁴⁸⁹ Shui T. 2001a, 250-256.

the periodization of the Chaiwangang and Xigang sites as suggested by the excavators (Fig. 105a; Fig. 105b).

As far as the relative chronology of each period of the Shajing culture is concerned, some stratigraphical evidence combined with the pottery complex proves that the first phase of Sanjiaocheng is roughly parallel to the Spring and Autumn period. Moreover, the first and second phase of Shajing is mostly equal to the Western Zhou period because some grey pottery shard with parallel and crisscross cord impressions, and water wave patterns found in the second layer of Saojiaocheng, are regarded as typical traits of the potteries in the Central Plain during the Spring and Autumn period⁴⁹⁰. In addition, some pocket-footed tripods-Li with double handles found at the Maojiaping, and Gangu sites in the Gansu Province, coexisted with some typical remains of the Spring and Autumn period.

Remains of the Shajing culture overlie on those of the Machang type, indicating their relative dates. So far, 9 radiocarbon dates from Saojiaocheng, Hamdun, Xigang and Chaiwangang are available (Appendix). Most of them fall between 900-400 BCE, roughly equal from the late Western Zhou period to the end of the Spring and Autumn period, which is in accordance with the deduction made by the archaeological evidence.

3.6.3 Metal objects

The Shajing culture was abundant with metal objects, especially bronze artifacts. In addition to a few copper and bronze objects found in Sanjiaocheng, Hamadun and Yushugou (Fig. 105c), the majority of metal objects were found at Xigang (Fig. 105d) and Chaiwangang (Fig. 105e). Apart from a small quantity of weapons and tools such as axes, knives and arrowheads, most of the metal objects of the Shajing culture consist of personal ornaments, including various tubes, buckles, bulbs, beads, bells, earrings, mirrors, animal figures and so on. Most of them were found in burials, and a number of them were discovered from the settlements at Saojiaocheng, implying that metal objects may have been regarded as a critical part of personal wealth. Generally, the metal complex is characterized by a strong smack of nomadic life, showing great similarities to the typical Northern bronzes, which is reflected not only in the shape and form, but also in the pattern and decoration. Some scholars speculated that the Shajing culture may have been created by the people who originated from the Ordos Plateau, and migrated westwards to the Hexi Corridor. Therefore, they had still kept their original traditions though they left the northern steppes. They influenced the local people as time went on. Thus, an advanced bronze culture took shape in

⁴⁹⁰ The excavators dated such potteries to the Warring States, while Shui Tao suggested that they belonged to the Spring and Autumn period.

northwest China⁴⁹¹.

The metal technology of the Shajing culture was well developed. Some iron and gold objects were also unearthed in graves together with bronze ones, suggesting a chronological difference. Of the hundreds of metal objects that have been identified as belonging to the Shajing culture, only some samples have been metallurgically examined. The Spectrographic Laboratory of the General Research Institute of Nonferrous Metals has examined some of the bronzes found at Xigang, Saojiaocheng and Shangtugougang with qualitative analysis and electric spark spectrum analysis. The results are as follows:

Site	Bronze items/sample	Elements				
		Cu	Sn	Pb	As	Alloy
Xigang	Knife 80YSXM429:1	√	√	√		Cu-Sn
Xigang	Knife 80YSXM421:6	√	√	√		Cu-Pb
Xigang	Knife 80YSXM140:3	√	√ trace	√		Cu-Pb
Sanjiaocheng	Arrowhead (big)	√	√	√		Cu-Pb-Sn
Sanjiaocheng	Arrowhead (middle)	√	√	√		Cu-Pb-Sn
Sanjiaocheng	Arrowhead (small)	√	√	√		Cu-Pb-Sn
Sanjiaocheng	Arrowhead (big)	√	√	√ trace		Cu-Pb-Sn
Shangtugougang	Ornament	√	√	√		Cu-Pb-Sn
Shangtugougang	Bulb	√	√ trace	√ trace	√	Cu

Table 24. Composition analysis of some bronzes in the Shajing culture⁴⁹².

From Table 24, we can see that the Cu-Pb-Sn alloy is relatively popular. By contrast, the Cu-As alloy is rarely seen. The bronze objects found at Xigang and Chaiwangang exceeded not only in quantity, but also in types and forms, than the other contemporary bronze cultures in northwest China, suggesting a more advanced metallurgical industry in the Shajing culture. More metallurgical analysis needs to be carried out.

⁴⁹¹ Xigangchaiwangang 2001, 202.

⁴⁹² Xigangchaiwangang 2001, 202.

3.7 Nuomuhong culture

3.7.1 Distribution, periodization, chronology, and origin

The designation of the Nuomuhong culture was first put forward in 1959 because of the excavation at Dalitaliha and Nuomuhong⁴⁹³. It is mainly distributed around the Tsaidam Basin, especially in the Dulan and Wulan regions. Until now, over 40 sites have been identified as belonging to the Nuomuhong culture, such as the Germu town⁴⁹⁴, Delingha town⁴⁹⁵, and Tianjun site⁴⁹⁶. It is a pity that only the Dalitaliha site was officially excavated, yielding the remains of adobe walls, adobe pits, houses, enclosures, and urn burials together with lots of potteries, stone and bone wares, and bronzes. Regarding the periodization of the Dalitaliha site, the description is inconsistent with the excavation report. The excavators firstly state that the remains from the fifth to the seventh layer are quite different to those found from the second to the fourth layer, and afterwards ascribe the remains from the seventh and sixth layer to the early stage, and the remains from the fifth to the second layer into the late stage. Therefore, the report on the Dalitaliha site aroused debate, especially on whether the Nuomuhong culture is an independent culture.

By re-comparing the related remains and layers at Dalitaliha, Shui Tao suggests that the Nuomuhong culture represents an independent culture. Meanwhile, he divides the Dalitaliha site into two periods: the first stage is from the seventh to the sixth stage; the late stage is from the fifth to the second stage (Fig. 106a)⁴⁹⁷.

Another opinion is inclined to believe that the remains of the Dalitaliha site probably originated or varied from the Kayue culture⁴⁹⁸, or both the remains of the Dalitaliha site and the Kayue culture represent two subtypes of a big culture⁴⁹⁹.

Based on the pottery complex and remains of the settlement, Zhang Wenli holds the view that the Nuomuhong culture contains not only elements of the Qijia culture but also elements of the late Kayue culture (Fig. 106b). In addition, he supports the fact that the Nuomuhong culture is an independent culture because the pots with straight walls, basins with four buttons, stone axes, felt and the special adobe technique used in the architecture are unique at the Dalitaliha site⁵⁰⁰.

As for the absolute date of the Nuomuhong culture concerned, so far two radiocarbon

⁴⁹³ QHW et al. 1963, 17-43.

⁴⁹⁴ DTJQH 1996.

⁴⁹⁵ QHW 1960b, 37-40.

⁴⁹⁶ Gu W. H. 1978, 69-70.

⁴⁹⁷ Shui T. 2001a, 271-273.

⁴⁹⁸ Zhao S. C. 1985, 635.

⁴⁹⁹ Xu/Ge 1988, 38-44.

⁵⁰⁰ ZWL 2003, 37-40.

dates from the Dalitaliha site are accessible (Appendix). The date from the third layer seems too early. Considering the elements of the Qijia culture and late Kayue culture contained in the Nuomuhong culture, we may infer that it falls in the first half of the millennia BCE, from the middle Western Zhou period to the Warring States period. More archaeological discoveries and research on this culture are hoped.

3.7.2 Bronzes

The bronzes of the Nuomuhong culture are relatively less in quantity and variety, and were mainly found at the Dalitaliha site⁵⁰¹, the Baishui River⁵⁰², and the Buha River⁵⁰³ (Table 25), including axe, Yue (battle axe), knife, awl, tube, arrowhead and nail (Fig. 106c). It is considerably difficult to tell the chronology of these bronzes because most of them were collected from the surface. When comparing the counterpart bronzes from the other cultures such as axes, Yue, knives, and tubes, we can infer that these bronzes of the Nuomuhong culture may be parallel to the Western Zhou period.

Site	Amount and items of the bronzes	Reference
Dalitaliha	Yue 1; axe 3; awl 1; arrowhead 1; nail 1;	QHW et al. 1963, 17-43.
Dalitaliha	Fragment	DitujiQH 1996, 185.
Buha	Tube 1	Gu W. H. 1978, 69-70.
?	Awl 1	Xu/Ge 1988, 35-44.
Baishui	Knife 1	DitujiQH 1996, 193.

Table 25. Copper and bronze objects of the Nuomuhong culture⁵⁰⁴.

No metallurgical analysis has been carried out on the copper and bronze objects of the Nuomuhong culture. From archeological observation, the open and composite molds may have been used for some bronzes. Meanwhile, some bronze slag and fragments were found at the Dalitaliha site, implying the possibility of a local metallurgical industry. More fieldwork and scientific metallurgical analysis leave much to be desired.

3.8 Tangwang-style-pottery and others

The address of the ‘Tangwang-style-pottery’ was first put forward by An Zhimin in the 1950s in light of the pottery complex collected from the Tangwangchuan site⁵⁰⁵. It designates the assemblage of pots with black-painted spire patterns on a violet slip, pots with two big ears in the neck or belly, and vessel-Dou with handle (Fig. 107a). Such assemblages were mainly discovered in the Gansu and Qinghai regions. Its

⁵⁰¹ QHW et al. 1963, 17-43.

⁵⁰² DTJQH 1996.

⁵⁰³ Gu W. H. 1979, 69-70.

⁵⁰⁴ ZWL 2003, 76.

⁵⁰⁵ An Z. M. 1957, 23-31.

distribution has reached the Yongjing county in Gansu in the east, the Gangcha county in the northwest, and Guinan in the southwest. According to the recent surveys, the Tangwang-style-pottery was centered in the Qinghai region. The major sites of the Tangwang-style-pottery have not been scientifically excavated.

In fact, the arguments over the designation, characteristics, and ascription of the Tangwang-style-pottery have never been solved. There are two main opinions. One is presented by Xu Yongjie, that Tangwang-style-pottery represents one independent Bronze Age culture, parallel to the Kayue culture and the Xindian culture. Furthermore, the typical Tangwang-style-pottery includes pots with two angulated ears, painted pots with big double ears, pots with round belly, Dou with handle, tripod-Li with handle and so on⁵⁰⁶. Another opinion is inclined to believe that Tangwang-style-pottery cannot be classified as an independent culture; however, it belongs to either the Kayue culture⁵⁰⁷ or the Xindian culture⁵⁰⁸.

Nevertheless, the individuality of the Tangwang-style-pottery is convincing. On the other hand, stratigraphical evidence at the Ahatela, Suhusa, Shangsunjiashai, and Xiaohandi sites proves that this so-called Tangwang-style-pottery coexisted with the Kayue culture and the Xindian culture, so their close connections cannot be neglected. Zhang Wenli has completed a comprehensive research on the periodization and comparison of the Tangwang-style-pottery (Fig. 107a; Fig. 107b) on the basis of coexisting relations and comparing this kind of assemblage to different sites and cultures⁵⁰⁹.

The origin and offspring of the Tangwang-style-pottery have aroused discussions and disputes amongst scholars for a long time. Some scholars suggest that it should have developed from the Kayue or Xindian culture⁵¹⁰. Whereas Zhao Jianlong holds the view that, it should have come from the Siba culture⁵¹¹. Xu Yongjie puts forward that the main body of the Tangwang-style-pottery originated from the Qijia culture as well as being influenced by other cultures⁵¹². In general, the origin of the Tangwang-style-pottery is much related to the Qijia and Siba cultures.

The offspring of the Tangwang-style-pottery is not clear at present. Some pots with two ears in the belly and Dou with single handle found at Subashen, and painted Dou

⁵⁰⁶ Xu Y. J. 1993, 166-203.

⁵⁰⁷ Yu W. C. 1985a, 193-210.

⁵⁰⁸ Yan W. M. 1978, 62-76.

⁵⁰⁹ ZWL 2003, 40-45.

⁵¹⁰ Yu W. C. 1985a, 193-210; Zhao/Nan 1988, 1-6.

⁵¹¹ Zhao J. L. 1992, 67-74.

⁵¹² Xu Y. J. 1993, 8-16.

with a high ring base and bridge-shaped ears found at Nianbulake⁵¹³ are quite similar to the Tangwang-style-pottery. However, it is hard to tell whether or not they had direct connections.

In light of the coexisting relationship of the potteries, Zhang Wenli states that some radiocarbon from the Shangsunjiashai and Ahatela sites (see Appendix) can be regarded as evidence of the absolute dates for the Tangwang-style-pottery as well⁵¹⁴. The radiocarbon dates are approximately from the end of the Western Zhou to the middle of the Spring and Autumn period. Zhang Wenli proposes that the Tangwang-style-pottery started from the end of the Shang period, and ended in the late Spring and Autumn period.

In general, due to a lack of sufficient discoveries and excavations, it is hard to regard the Tangwang-style-pottery as an independent culture in northwest China. However, the classification and identification of the Tangwang-style-pottery is quite valuable in understanding the relations between the Kayue, Xindian, Siba, Qijia, and Machang cultures. Besides, metal objects of the Tangwang-style-pottery are not well known.

3.9 Summary

3.9.1 Origin and development of the bronze cultures

In light of the distribution, chronology, and periodization of the potteries and bronze assemblages of each culture that have been discussed above, this study believes that they are continuous both in cultural aspects and chronological sequence (Fig. 136), implying from another viewpoint that an indigenous bronze metallurgy was possible at that time in northwest China.

The Qijia culture, the earliest bronze culture in northwest China, is speculated to have originated either from the Neolithic culture Majiaoyao, which is distributed in the middle and west of the Gansu region, or from the remains of the Longshan period located in east of the Gansu region. According to the materials found from the Liuwan and Huangniangniangtai cemeteries, there was a transitional type⁵¹⁵ with close relations to the Siba culture, which originated from the Machang type and was parallel to the Qijia culture for a long time.

Scholars pay much attention to the origin of the Siba culture. Some hold the view that the Majiaoyao culture polarized into two regions during the Machang period: the east

⁵¹³ Subashen and Nianbulake are situated in the Xinjiang Province.

⁵¹⁴ C14 91.

⁵¹⁵ Scholars represented by Shui Tao and Li Shuicheng, believe that there is a transitional type between the Qijia culture and Siba culture.

region developed into the Qijia culture; however, the Siba culture came into being in the west (Map 1; Map 12). In recent research, the so-called 'transitional type' was regarded as the origin of the Siba culture. It is characterized by black and black-brown painted jars with double ears, a round belly and flat base. Similar kinds of remains have been identified in the Huoshaogou cemetery, Liuwan cemetery and Yuanyangchi cemetery in Yongchang county. Some potteries in the early Siba culture are quite similar to those in the late Qijia culture. Accordingly, some scholars represented by Shui Tao and Li Shuicheng, believe that the Siba culture may have originated from the 'transitional type'⁵¹⁶. Some excavation of the Siba culture is not yet published, therefore this view needs to be proven.

Recent research has thrown great light on the origin of the Kayue culture too. Though there is a gap of 200 years between the late Qijia culture and the early Kayue culture, forms and patterns of some painted potteries of the early Kayue culture, especially found in the Ahatela site (Fig. 101b) show distinct similarities to those of the late Qijia culture (Fig. 099a) and the Machang type.

The Xindian and Kayue cultures are not only roughly parallel in chronology but also share a cross-area in border between the middle-west Gansu and north Qinghai (Map 9, Map 10). Many characteristics of the early Xindian culture can be also seen in the late Qijia culture, such as the cord patterns, jars with a round belly and round base, ears on the same level with a ring and so on (Fig. 099a,c; Fig. 100a-d). Furthermore, the painted potteries of the Xindian culture are close to those of the late Qijia culture which were supposed to have originated from the Machang culture. Furthermore, Shui Tao puts forward that the early Xindian culture in east Gansu shows connections with the pre-Zhou culture.

The Siwa culture, a little bit later than the Xindian culture, coexisted with the Xindian and Kayue cultures for a long time. It was distributed southeast of the Xindian culture in south Gansu. A lack of sufficient discoveries from the early Siwa culture makes it harder to explore its origin. Some scholars suggest that the Qijia culture developed into the Siwa culture in the east, and into the Kayue culture in the west⁵¹⁷. However, we cannot explain the large time gap between the Siwa and Qijia culture (Fig. 136). Nevertheless, as discussed in the above sections, the close ties between the Xindian culture and the Siwa culture are noticeable.

A lack of sufficient evidence also makes it hard to discuss the origin of the Tangwang-style pottery, which was parallel to the Kayue and Xindian cultures for a while.

⁵¹⁶ Shui T. 2001, 275.

⁵¹⁷ Yu W. C. 1985a, 193-210.

Whether the Tangwang-style pottery can represent an independent culture is still in argument, however its individuality helps us to understand the complicated relations between the Kayue, Xindian and Qijia cultures.

As for the Nuomuhong culture, more archaeological discoveries need to be supplemented. Wherever it came from, the influence from the late Kayue culture is reflected in some potteries and bronzes. Moreover, the adobe techniques, wooly goods, and some painted potteries show similarities to those found in the east Xinjiang region.

When compared to the other bronze cultures mentioned above, the Shajing culture, which appeared roughly in the Middle Western Zhou period or even earlier, may have a totally different origin. Double-eared jars, pots with ears at their belly and single-eared jars were very popular; a drum-shaped belly, round base, and painting patterns with triangles and diamonds were very common. Such features can be traced to the middle Western Zhou cultures. The report on the excavation at Xigang and Chiwangang in 2007 provides us with new information on the Shajing culture, especially the bronze assemblages. Personal ornaments constitute the main body of them, as well as some weapons and tools, showing a great similarity to the northern bronzes. We still cannot judge where the Shajing culture came from, but it seems impossible for it to have derived directly from an earlier bronze culture.

3.9.2 Spatial distribution and interactions

These bronze cultures distributed in different areas and different periods, consist of the main body of the Northwest Complex. Their cross correlations are quite complicated, reflected in three aspects.

Firstly, there is not any so-called leading or dominating culture. All the cultures are scattered on a small scale throughout northwest China. However, they have their own individuality though they communicated with each other frequently. Secondly, some cultures coexisted for a long time side by side in different areas, such as the Kayue, Xindian, and Siwa cultures; thirdly, the origins of these cultures are not singular. Normally a later culture originated from an earlier culture, meanwhile absorbed foreign elements from the neighboring cultures.

As for the research on the metal objects in these cultures, it has been largely restricted to the traditional typology analysis. Nevertheless, there is a growing tendency for the metallurgical analysis of the bronzes found from the Gansu region. By contrast, very little metallurgical work has been undertaken on the bronzes found in the Qinghai region; accordingly, it is difficult to reconstruct the ancient metallurgical industry in this area. Despite this, some scholars speculate some manufacturing technique by

archaeological observation. It would be great if Chinese scholars pay more attention to metallurgical analysis in the future, which will definitely provide us with new clues towards a better understanding of the earliest metallurgy in northwest China. Besides, only a small quantity of radiocarbon dates are available so far. Therefore, it would be contentious to date a culture mainly based on the pottery complex, bronze assemblage and so on.

Chapter 4 The North-central Complex

The definition of the North-central Complex is almost in accordance with Pak's⁵¹⁸. It designates the bronze-using cultures in south central Inner Mongolia and adjacent areas, including northern Shaanxi, northwestern Shanxi, the Qingyang region in Gansu, and Ningxia. However, apart from the Zhukaigou culture, Maoqinggou culture, and Yanglang culture mentioned by Pak, some new cultures have been recently identified and recognized with the increasing archaeological discoveries. They include the Lijiaya culture, Xicha culture, and Taohongbala culture.

4.1 Zhukaigou culture

4.1.1 Definition and distribution

The Zhukaigou culture was first put forward in 1988, named after the Zhukaigou site, which is located in Yijinhuluoqi, Yikezhaomeng, Inner Mongolia⁵¹⁹. Four field seasons at the Zhukaigou site yielded a total of 83 houses, 207 ash pits, 329 burials, and 19 urn burials. The archaeological remains discovered from this site include over 510 potteries, 270 stone wares, 420 bone wares, and 50 bronze objects. The excavators represented by Tian Guangjin, divided the Zhukaigou site into five stages. The first stage is parallel to the late Longshan period. The second stage is close to the end of the Longshan period and the beginning of the Xia period. The third stage is contemporary with the early Xia period; the fourth stage is equal to the late Xia period; and the fifth stage is close to the period of the Upper Erligang culture in the Shang Dynasty. This opinion has commenced a heated controversy.

Except for some different opinions on the periodization of the Zhukaigou site⁵²⁰, the scholars doubt whether the entire remains of the five stages of the Zhukaigou site belong to the Zhukaigou culture. Li Boqian points out that the typical Li-tripods with serpent motif are absent in the first stage of the Zhukaigou site⁵²¹. Afterwards, Cui Xuan puts forward that it is not appropriate to ascribe all the remains of the Zhukaigou site into the Zhukaigou culture, because the remains during the first to fourth stage, found in the burials are absent in the settlements. Furthermore, he classifies the remains of the Zhukaigou site into four groups, and only the third group

⁵¹⁸ Pak Y. J. 1996, 218.

⁵¹⁹ NMGY 1988, 301-331.

⁵²⁰ Zhang Zhongpei suggests that it should be divided into three periods: the first period is represented by the tripods-Li with a handle; the second period is marked by the tripods-Li with a high neck; the third is characterized by the coil ringed tripods-Li with sack-shaped feet (Zhang Z. P. 1990d, 209-213).

⁵²¹ Li B. Q. 1991.

represents the Zhukaigou culture⁵²². As stated by Wei Jian, it is from the third stage, the Zhukaigou site belonged to the Zhukaigou culture⁵²³. This study prefers to exclude the first stage of the Zhukaigou site from the Zhukaigou culture, because not only was this stage parallel to the late Longshan period but also it was after the second stage that the tripods-Li with serpent patterns appeared.

Despite this, the ascription of the Zhukaigou site and the Zhukaigou culture are still in dispute, as the bronze objects and Li-tripods with serpent motif are regarded as the main characteristics of the Zhukaigou culture. Therefore, in addition to the Zhukaigou site, Erliban⁵²⁴, Nanhao⁵²⁵, Gaojiaping⁵²⁶, Baiaobao⁵²⁷, Bainiyaozi⁵²⁸, Zhaizita⁵²⁹, Yangchanggou⁵³⁰, Zhuangwoping⁵³¹, Guandi⁵³², and Haishengbulang⁵³³ were also confirmed as belonging to the Zhukaigou culture. Very few bronze objects have been unearthed in these sites. According to present day fieldwork, the Zhukaigou culture is mainly distributed to the south and middle of the Inner Mongolia region, centering on the Ordos Plateau and the area near the Liangcheng county (Map 15).

4.1.2 Periodization and chronology

As an early Bronze Age culture in northern China, the opinions on the periodization and chronology of the Zhukaigou culture still differ greatly to this day. One is represented by Tian Guangjin, who first divides the Zhukaigou culture into five stages in light of the remains from the Zhukaigou site as mentioned above. Furthermore, he believes there is a strong cultural continuity from the first stage to the fourth stage of the Zhukaigou site, though a possible short lapse exists between the fourth and fifth stage. In his subsequent articles, he ascribes the Zhukaigou culture into three periods and five stages, and suggests a chronology from the late Longshan period to the early Shang period⁵³⁴.

Another statement is put forward by Wei Jian and Cui Xuan, that the Zhukaigou culture flourished during the Xia and early Shang period, and declined during the late Shang period until the Western Zhou period. Besides, it is from the third stage of the Zhukaigou site that it belonged to the Zhukaigou culture⁵³⁵.

⁵²² Cui X. 1991, 361-371.

⁵²³ Wei/Cui 1994, 125-143.

⁵²⁴ NMGY 1997a, 84-129.

⁵²⁵ NMGY 1994, 205-224.

⁵²⁶ YKW 1994, 261-271.

⁵²⁷ NMGY et al. 1997, 327-337.

⁵²⁸ NMGL 1966, 115-121.

⁵²⁹ NMGY 1997b, 280-326.

⁵³⁰ BD 1991.

⁵³¹ WLB et al. 1997.

⁵³² NMGY 1997c, 85-119.

⁵³³ BD et al. 1997, 196-239.

⁵³⁴ Zhukaigou 2000, 285.

⁵³⁵ Wei/Cui 1994, 125-143.

Lü Zhirong suggests that the Zhukaigou culture started from the end of the fourth stage of the Erligang culture, and terminated in the second period of the Yinshang culture. Moreover, the tomb M2007 at Zhukaigou, the remains of the early period of the Gaojiaping site, and the remains of the Nanhao site represent the first stage of the Zhukaigou culture. The second stage is represented by tomb M2004, tomb M1052, and house H5030 of the Zhukaigou site, the remains of the Zhaizita site, and the first group remains of the Guandi site. QH78, QH79, H4006, M1040, M1046 of the Zhukaigou site, the second group remains of the Zhaizita site, and the D point of the Bainiyaozi site represent the third stage. The fourth stage is represented by the fourth group remains of the Zhaizita site, the remains of the Yangchanggou and Wozhuangping site, and the remains of the late Gaojiaping site.

Based on the above-mentioned opinions, Wu En divides the Zhukaigou culture into three periods. The early period is represented by the remains of the second and third stage of the Zhukaigou site⁵³⁶, the Zhukaigou culture remains at Erliban, the early remains of the Gaojiaping site, the Zhukaigou culture remains at Nanhao, remains of the fourth stage of the Zhuangwoping site, and remains of phase I in the fourth stage of the Zhaizita site. It is parallel to the first and second stage of the Erlitou culture (1900-1600 BCE). The early period is characterized by Li-tripods with a serpent motif, pots with buttons (Fig. 108a, 1.2; 9.12), and patterns of basket and cord. Some small bronze objects, such as chisels, awls, rings, needles and loops were found at Wozhuangping and Zhukaigou. The middle period includes: the remains from the fourth stage of the Zhukaigou site, the late Gaojiaping site, the fifth stage of the Guandi site, phase II within the fourth stage of the Zhaizita site, the Yangchanggou site, the fifth group of the Bainiyaozi site, and the Haishengbulang site. It is close to the period of the third and fourth stage of the Erlitou culture, dating to 1600-1500 BCE. Moreover, the middle period is recognised by the assemblage of the serpent motif Li-tripods, pots with buttons and Urns with three feet (Fig. 108a, 3.10.13.7). By contrast, the basket motif decreased and the serpent motif increased during this period, and some bronze objects also appeared. The late period is represented by the remains from the fifth stage of the Zhukaigou site, the phase III of the fourth stage of the Zhaizita site, and the D point of the Bainiyaozi site, which is roughly close to 1500-1200 BCE. Li-tripods with serpent motifs and gritty pots with buttons dominated this period (Fig. 108a, 4.5.11.14). Many potteries with elements of the Erligang culture appeared, such as Li, Gui (Fig. 108b, 10) and Dou (Fig. 108b, 9). In addition, more big bronze objects were found, including Jue-vessels, Ding-cooking tripods, swords, battle daggers, knives, guards and so on.

⁵³⁶ According to the periodization supposed by Tian G. J..

As for the absolute dates of the Zhukaigou culture, so far six radiocarbon dates are available. Four of them also positively support their relative chronology as proposed by archaeologists (Appendix). Conclusively, the Zhukaigou culture falls roughly between 1900-1200 BCE, parallel from the Xia period to the late Shang period.

4.1.3 Cultural elements

The cultural elements contained in the Zhukaigou culture are quite complicated. In addition to the serpent-motif Li-tripods (Fig. 108a, 1-5), which appeared in the third stage of the Zhukaigou site and are considered to be one of the most important representative pottery vessels of the Zhukaigou culture, the assemblage of the so-called Northern-style bronzes (Fig. 108c, 1-15) and objects with a strong Central Plain style (Fig. 108b, 9.10; Fig. 108c, 16-19) are quite distinctive.

The bronze tripod-Ding and daggers (Fig. 108c, 16-19), pottery Dou and Gui (Fig. 108b, 9.10) reflect close relations to the Central Plain. In addition, bronze knives, arrowheads, and earrings of the Zhukaigou culture show similarities to those of the Qijia and Siba cultures that appeared earlier in northwest China. Accordingly, the bronze metallurgy in the Zhukaigou culture may well have originated from the northwest, meanwhile absorbed elements from the Central Plain.

In addition to the Qingyang region, the serpent-motif potteries have been found as far away as eastern and northern Mongolia, and in the Trans-Baikal area of Siberia (Fig. 108i). Though the chronology and ascription of such potteries are still in dispute, Russian archaeologists are almost in agreement with the suggestion that they may have originated from the Yellow River region. A Chinese scholar, Wu En, supports this opinion and remarks that the serpent-motif pottery may have originated from the Zhukaigou culture or the Zhukaigou culture disseminated towards the north at that time⁵³⁷.

The Zhukaigou culture is regarded as one of the earliest bronze-using cultures in the west of north-central China. The advent of bronze metallurgy falls roughly into the early second millennia BCE. Following this culture, a more advanced bronze-using culture appeared, characterized by distinctive traits of the so-called 'Ordos bronzes'.

4.1.4 Metal objects

4.1.4.1 Types

After the third stage of the Zhukaigou site⁵³⁸, small quantities of bronze artifacts were discovered at Zhukaigou (Table 26) and Wozhuangping, which are so far the earliest

⁵³⁷ Beifangcaoyuan 2007, 85.86.

⁵³⁸ According to the periodization by the excavator, Tian G. J. .

bronze objects discovered from the middle section of North-central China.

As shown in Table 26, bronze objects found from the third and fourth stage occurred only in limited numbers. It was during the fifth stage, close to the early Shang or the Upper Erligang period that many different kinds of bronze objects began to be buried in tombs. These bronze artifacts consisted of not only small ornaments, such as earrings, rings, bracelets, awls and needles, but also weapons and tools, including swords, knives, arrowheads, Mou-helmets and guards (Fig. 108c, 1-19). It should be noted that Lin Yun regards one bronze loop with a mushroom end and point end (Fig. 108c, 13) as a kind of headdress for one's temple in light of two similar gold loops (Fig. 108c, 20), which was discovered from one tomb at Tebuxiwula, Inner Mongolia⁵³⁹, dating to the last half of the second millennia BCE.

As stated by the excavators, the local metallurgical industry may have existed in the Zhukaigou culture because one broken stone mold for an axe was unearthed from square T102②. However, some bronze Ding-cooking wares for rites (Fig. 108c, 16), Jue-vessels and battle daggers (Fig. 108c, 17-19) were discovered as well, and they were probably imported from the Central Plain.

4.1.4.2 Metallurgical analysis

Metallographic and scanning electron microscope analysis, have been used to determine the compositions and microstructure of these samples, and to research their manufacturing techniques. Most of the samples were selected from broken parts of the artifacts. The metallurgist used a 0.1mm Mo-wire cutter machine to cut a small piece from complete samples, and fixed the cut pieces back into the original artifacts after the analysis. The samples were mounted and polished, then etched in a $\text{FeCl}_3 + \text{HCL} + \text{alcohol}$ solution. An optical microscope and SEM were used to observe the microstructure. Analysis of the compositions were conducted using an SEM-Cambridge S-250 MK3 with a link AN10000 energy spectrum (or EDS). The acceleration voltage was 20kv. The working distance was fixed. Considering the possible compositional segregation in the cast structure, the electron beam was selected and maximized. The surface scanning method was adopted in order to determine the composition of each object⁵⁴⁰.

Thirty-three of the forty-three metal artifacts of the Zhukaigou site, discovered without being disturbed, have been analyzed by the University of Science and Technology Beijing (Table 26; Table 27).

⁵³⁹ Lin Y. 2002, 1-12.

⁵⁴⁰ Linduff et al. 2000, 256-257.

	Stage III (1900-1700BCE)	Stage IV (1700-1600 BCE)	Stage IV (1500-1300 BCE)	Sum
Weapon		Arrowhead (M4040:1)	4 battle daggers (M1040:1, M1052, M1083, M2012); 1 broken dagger (H5028:3); sword (M1040:2), Mou (M1083), 4 arrowheads (F5001:1-3, H5003:7), 2 broken arrowheads (H5003:11, H5028)	14
Tool	Chisel (T230 ③:1); Awl (H1044:1); Needle (T238 ③:1)		Knife (M1040:3), 3 broken knives (H5028:1, H5028:2, H5028)	7
Daily ware			Broken Ding (H5028:4); foot of Jue (H5028:5); Jue (H5028:5)	3
ornament	2 Bracelets (M4007:2; M4035:1); Earring; ring	3 rings (M4003:1, M4060:6, M6011:4); 5 collected earrings	4 plaques (M1040); loop (M1070); 2 earrings (M2012:2, T124②:1)	19
Sum.	7	9	27	43

Table 26. Bronzes of the Zhukaigou site⁵⁴¹.

	Stage III (1900-1700BCE)	Stage IV (1700-1600 BCE)	Stage IV (1500-1300 BCE)	Sum
weapon		Arrowhead (M4040:1)	1 battle dagger (M1040:1); broken dagger (H5028:3); sword (M1040:2); 4 arrowheads (F5001:1-3, H5003:7), 2 broken arrowheads (H5003:11, H5028)	14
tool	Chisel (T230 ③:1); Awl (H1044:1); Needle (T238		Knife (M1040:3), 3 broken knives (H5028:1, H5028:2, H5028)	7

⁵⁴¹ Zhukaigou 2000.

	③:1)			
daily ware			Broken Ding (H5028:4); foot of Jue (H5028:5); Jue (H5028:5)	3
ornament	2 Bracelets (M4007:2, M4035:1);	2 rings (M4060:6, M6011:4); 5 collected earrings	1 plaque (M1040:4); loop (M1070); 2 earrings (M2012:2, T124②:1)	19
sum.	5	8	20	33

Table 27. Bronzes of the Zhukaigou culture that have been analyzed (adapted from Li/Han 2002, 243 Table 2).

Sam. No.	Original No.	Artifact	Position of sampling	Composition					Material
				Cu	Sn	Pb	S	Other	
2692	T238③:1	needle	broken part	86.2	10.6	2.4	0.2	Ag0.6	Cu-Sn-Pb
2696	T230③:1	chisel	edge	89.5	9.2	<0.1	0.2	CL0.3	Cu-Sn
2673	H1044:1	awl	end of handle	92.3	<0.1	1.3	—	Mg4.0 As1.6	Cu
2697	M4007:2	armlet	broken part	98.9	<0.1	<0.1	<0.1	—	Cu
2698	M4035:1	armlet	Not yet sampled	√					Cu
2693	M4040:1	arrow	end of shaft	91.5	6.1	2.1	<0.1	—	Cu-Sn-Pb
2694	M4060:6	ring	end of point	98.4	<0.1	0.9	0.1	—	Cu
2695	M6011:4	ring	Not yet sampled	√					Cu
2699-1	collected	earring	broken part	84.2	12.5	2.2	0.3	CL0.3	Cu-Sn-Pb
				89.9	8.6	1.5	—	—	Cu-Sn
2699-2	collected	earring	broken part	81.3	17.0	<0.1	<0.1	C11.0	Cu-Sn
				90.9	8.9	<0.1	—	—	Cu-Sn
2699-3	collected	earring	broken part	89.8	8.3	1.5	0.3	—	Cu-Sn
2700	collected	earring	broken part	90.4	8.6	<0.1	0.3	—	Cu-Sn
2701	collected	earring	broken part	89.3	8.9	1.4		—	Cu-Sn

Table 28. Composition of the bronze artifacts from the third and fourth stage of the Zhukaigou site: √ means that it contains this element; - means this element hasn't been identified (adapted from Li/Han 2002, 243 Table 3).

Sam. No.	Excavated Object No.	Artifact	Position of sampling	Composition					Material
				Cu	Sn	Pb	Fe	others	
2647	M1040:2	sword	edge	82.1	14.2	2.3	<0.1	Ag 1.4	Cu-Sn-Pb
2646	M1040:3	knife	edge	91.3	8.2	—	0.5	—	Cu-Sn
2645	M1040:1	dagger	edge	80.0	15.0	4.7	<0.1	—	Cu-Sn-Pb
2691	M1040:4	plaque	whole body	√	√	√			Cu-Sn-Pb
2655	M1070	ring (incomplete etc)	broken part	87.5	11.3	—	—	Cl 1.0	Cu-Sn
2689	M2012:2	earring	broken part	84.5	11.0	0.7	<0.1	Mg 3.3	Cu-Sn
2687	H5003:7	arrow	End part of shaft	90.4	5.8	1.2	0	Mg 2.4	Cu-Sn
2684	H5003:1 1	Tang of arrow	broken part	77.7	15.3	3.2	<0.1	Mg 3.6 As 1.4	Cu-Sn-Pb
2670	H5028:1	handle of knife	broken part	71.8	23.9	3.2	<0.1	Ag 6.8	Cu-Sn-Pb
2669	H5028:2	point of knife	broken part	60.8	32.5	4.7	—	Ag 1.1 Mg 2.0 Cl 1.0	Cu-Sn-Pb
2683	H5028	fragment of knife	broken part	58.7	35.9	<0.1	<0.1	Cl 4.4	Cu-Sn
				79.7	16.8	<0.1	<0.1	Mg 1.7 As 0.4	Cu-Sn
2686	H5028:3	fragment of dagger	broken part	77.4	5.4	1.1	<0.1	As 6.8	Cu-Sn-As
2671	H5028:4	fragment of Ding	broken part	55.6	13.0	30.8	—	—	Cu-Sn-Pb
2672	H5028:5	foot of Jue	broken part	65.7	14.0	20.4	—	—	Cu-Sn-Pb
2690	H5028:5	fragment of Jue	broken part	63.2	16.5	26.7	<0.1	Mg 1.8	Cu-Sn-Pb
				81.3	15.6	0	<0.1	Mg 2.1	Cu-Sn
2674	H5028	arrow	broken part	55.5	9.6	33.7	—	Cl 1.2	Cu-Sn-Pb
2685-1	F5001:1	arrow	end part of shaft	50.3	9.5	37.5	0	Mg 2.4	Cu-Sn-Pb
				81.9	11.7	2.7	<0.1	Mg 2.3	Cu-Sn
2685-2	F5001:2	arrow	end part of shaft	58.4	9.4	29.4	<0.1	Mg 2.0	Cu-Sn-Pb
2685-3	F5001:3	arrow	end part of shaft	52.4	8.7	35.3		Ag 1.6	Cu-Sn-Pb
2688	T124②:1	earring	broken part	75.0	8.5	12.7	<0.1	Mg 2.5 As 0.3	Cu-Sn-Pb

Table 29. Composition of the bronzes from the fifth stage of the Zhukaigou site

(adapted from Li/Han 2002, 244 Table 4).

The results show: during the third and fourth stage of the Zhukaigou site, 39% of the metal objects are copper; 54% are forged and 70% of them are small ornaments (Table 28). By contrast, during the fifth stage, no copper is identified; all of them are arsenical copper; five of them are Cu-Sn alloy; fourteen of them are Cu-Sn-Pb alloy (Table 29). This evidence indicates the matured metallurgical techniques used in the fifth stage at Zhukaigou. In addition, five Cu-Sn alloys contain less than 2% Pb. These objects has about 6-17% Sn. The decoration of these objects was very simple. Among the 13 sampled Cu-Sn-Pb alloys, five contained less than 5% Pb, and five contained more than 30% Pb. The size, shape, and distribution of Pb depends on the content and manufacturing technology used.

As for the metallurgical structure, 31 of the 33 samples have been examined. As we can see in Table 32, four bronze artifacts were cast; three were hot worked, another three were cold worked; and one cast artifact was slightly cold worked. According to Table 33, of the 20 bronzes found from the fifth stage of the Zhukaigou site, three were formed by cast; three were hot worked; five cast objects were slightly cold and hot worked; another six cast objects were hot worked. Special attention should be paid to object H5028:3 Ge (2686), since it is a Cu-Sn-As alloy containing 6.8% As. The object found in H5028, was artificially broken, and reheated on the surface. Metallurgical observation clearly shows dendritic segregation, but the structure is different from a Cu-Sn-Pb alloy. Further analysis indicated that the bright zone of As and Zn content is higher than the matrix by about 2.5 times. Not many early Shang period bronze objects contain As-other than this sample found at Zhukaigou, we also have two others and they contain 0.3-1.4% As⁵⁴². In addition, the mechanical properties of some bronzes have also been analyzed, including the hardness, intensity of tension, and elongations (Table 31). This provides us with clues to understand the different manufacturing techniques used in copper and distinct alloys. Additional lead enhances the fluidity of the alloy and wearability of metal products. In general, the metallurgical results indicate that the copper and bronze objects found at the Zhukaigou site were provided with a local character.

	Copper	Manufacturing technique	Artifacts	Tiny composition
Stage III, IV	39%	54% forged	Small ornaments (70%); no containers	Second-phase with Sn, Pb, Bi, As, Sb and Bi, Te, Sb, Ag or Bi, Su, Pb, Te

⁵⁴² Linduff et al. 2000, 262.

Stage V	No	Mostly cast; 3 by heat work	More weapons; some Ding, Jue appeared	Ag, Fe, As
---------	----	-----------------------------	---------------------------------------	------------

Table 30. Comparing the bronze objects between the third and fourth stage and the fifth stage of the Zhukaigou site.

Lab. No.	Original no.	Artifact	Element		Mechanical property		
			Sn (%)	Pb (%)	Intensity of tension (kg/mm ²)	Hardness	Percentage of elongations (%)
2693	M4040:1	Arrow	6.1	2.1	31	78	50
2684	H5003:11	Tang of arrow	15.3	3.2	29	140	8
2685-1	F5001:1	Arrow	9.5	37.5	< 9	70	0
2685-2	F5001:2	Arrow	9.4	29.4	20	74	2
2685-3	F5001:3	Arrow	8.7	35.3	15	70	0
2674	H5028	Arrow	9.6	33.7	12	70	1
2692	T238③:1	Needle	10.6	2.4	31	105	20
2645	M1040:1	Dagger	15.0	4.7	29	140	7
2647	M1040:2	Sword	14.2	2.3	30	135	9
2646	M1040:3	Knife	8.2	0	35	95	30

Table 31. Mechanical properties of the bronzes discovered from the Zhukaigou site (adapted from Li/Han 2002, 252 Table 10; Table 11).

Lab. No.	Sample No.	Artifact	Metallurgical structure and observation	Manufacturing technique	Remarks
2692	T238③:1	Needle	There are obvious slip lines in the matrix, containing some Pb grains mixed with Cu ₂ S grains.	cold and hot worked	Fig. 108e, 1
2696	T230③:1	Chisel	There is obvious solid solution of dendritic segregation and tiny ($\alpha+\delta$) solid solution.	cast	Fig. 108e, 2
2673	H1044:1	Awl	α solid solution in matrix has an obvious segregation which is composed of Ab and Sn; there are also some Pb grains and a tiny second image composed of Pb, Sn, Sb, As and Bi.	cast	Fig. 108e, 3
2697	M4007:2	Armlet	There is obvious α solid solution segregation which is caused by uneven distribution of Zn element; some (Cu+Cu ₂ O) eutectic crystals are distributed in the boundary of the crystals; there are some second-image particles containing Bi, Te, Sb, Ag, and As.	cast	Fig. 108e, 4
2693	M4040:1	Arrow	α solid solution segregation is obvious; edge of the sample is rusty; there are some Pb particles.	cast	Fig. 108e, 5
2694	M4040:6	Ring	There is obvious α solid solution segregation, some slip lines, Pb particles, Cu ₂ S particles, and the second-image particles composed of Cu and Pb.	Cast then slightly cold worked	Fig. 108e, 6
2699-1	collected	Earring	α solid solution isometric crystals and twin crystals, and petty Pb particles are dispersedly distributed with tiny blue inclusions. Part of the edge is corroded.	hot worked	Fig. 109f, 1
2699-2	collected	Earring	It is heavily corroded so the edge of the inner crystals have been joined	hot worked	Fig. 109f, 2

			together like a net; there are α solid solution isometric crystals and twin crystals, which are mean in size; the corrosion produces Cu_2O ; there are also some tiny Cu_2O , Pb and Cu_2S particles.		
2699-3	collected	Earring	Some slip lines are distributed in the α solid solution isometric crystals and twin crystals; some inclusions with Cu_2S containing Sn or Fe; more slip lines are distributed along the edge; crystals are a little distorted.	hot and cold worked	Fig. 109f, 3
2700	collected	Earring	α solid solution isometric crystals and twin crystals are not even in size; some crystals have slip lines; some Cu_2S inclusions and second-image of Te and Bi are distributed around the boundaries of the crystals.	hot and cold worked	Fig. 109f, 4
2701	collected	Earring	It is heavily corroded. Some Pb particles and second-image particles composed of Pb, Cu and Sn are distributed along the boundaries in the solid solution isometric crystals and twin crystals.	hot worked	Fig. 109f, 5

Table 32. Results for the metallurgical structure of the bronzes from the third and fourth stage of the Zhukaigou site (adapted from Li/Han 2002, 247 Table 7).

Lab. No.	Sample No.	Artifact	Metallurgical structure and observation	Manufacturing technique	Remark
2647	M1040: 1	Sword	there are α solid solution equiaxial and twinned grains, dispersed lead particles, slightly curved twin boundary, and a lot of slip lines. No δ structure is found.	cast, then hot forged and cold worked	Fig. 108f, 6
2646	M1040: 2	Knife	α solid solution equiaxial and twinned grains, lots of slip lines were found in grains.	cast, then hot forged and cold worked	Fig. 108g, 1
2645	M1040:	Dagger	α solid solution equiaxial and slip lines, lead particles coexisted with Cu_2S ;	cast, then hot	Fig. 108g, 2

	3		there is a δ structure too.	forged and cold worked	
2691	M1040:4	Plaque	It is heavily corroded. Distribution of Pb particles is obscure; there is a distinct cast structure.	cast	
2655	M1070	Fragment of loop	It has a thick corroded layer. α isometric crystals and twin crystals with straight twin grains were distributed in boundaries.	hot-worked	Fig. 108g, 3
2689	M2012:2	Earring	There are α solid solution isometric crystals and twin crystals with straight boundaries, tiny inclusions composed of Fe, Cu, and S.	hot-worked	Fig. 108g, 4
2687	H5003:7	Arrow	α solid solution dendrite segregation is obvious. There are some gray-blue inclusions. No δ structure is found.	cast	Fig. 108g, 5
2684	H5003:11	Tang of arrow	There is an obvious α solid solution dendrite segregation, some (α + δ) structure, shrinkage cavity, and trace Pb particles.	cast	Fig. 108g, 6
2670	H5028:1	handle of knife	There are α solid solutions; boundary of the (α + δ) crystals is rusty.	cast and hot-worked	
2669	H5028:2	point of knife	There are α solid solution and ramified distributed (α + δ) crystals in boundary; it is very corrosive.	cast and hot-worked	
2683	H5028	Fragment of knife	α solid solution and ramified distributed (α + δ) crystals; it is high rusty.	cast and hot-worked	
2686	H5028:3	fragment of dagger	There is obvious segregation; it is very corrosive.	cast	Fig. 108h, 1.2
2671	H5028:4	fragment of Ding	Segregation of α solid solution dendrite-like grains is not distinctive; a little bit of δ structure; Pb particles are dendrite-like distributed; there are some isometric crystals and twin crystals in the edge.	Cast, item shattered to pieces hot-	Fig. 108h, 3

				worked	
2672	H5028:5	foot of Jue	There is obvious segregation of α solid solution dendrite-like grains, some δ structure, a few slip lines; Pb particles are distributed like dendrite or crumb, together with gray-blue inclusions.	Cast by crushing and heat	
2690	H5028:5	Fragment of Jue	Segregation of α solid solution dendrite-like grains is not distinct; some(α + δ) structures are located in the boundaries; Pb particles are unevenly distributed, together with some gray-blue inclusions; it is very corrosive.	Cast by heat	
2674	H5028	Arrow	Cast segregation is obvious; there are some gray-blue inclusions with Pb particles, and some slip lines.	Cast by crushing	Fig. 108h, 4
2685-1	F5001:1	Arrow	There are distinctive segregation of α solid solution dendrite-like grains and a little bit of (α + δ) structures; some gray-blue inclusions and crumbly-like Pb particles; some tiny isometric crystals and twin crystals are distributed along the boundary.	Slightly hot work after casting	
2685-2	F5001:2	Arrow	There are distinctive segregation of α solid solution dendrite-like grains and no (α + δ) structures; some gray-blue inclusions and some Pb particles	cast	
2685-3	F5001:3	Arrow	There are distinctive segregation of α solid solution dendrite-like grains and a little bit of δ structures; Pb particle is dendrite-like distributed.	cast	Fig. 108h, 5
2688	T124 ②:1	Earring	There are some fine α solid solution dendrite-like isometric crystals and twin crystals; Pb particles distributed along the processing direction and cast segregations. No δ structures are found.	hot worked	Fig. 108h, 6

Table 33. Results for the metallurgical structure of the bronzes from the fifth stage of the Zhukaigou site (adapted from Li/Han 2002, 248 Table 8).

4.2 Lijiaya culture

4.2.1 Definition and distribution

The Lijiaya culture is named after the Lijiaya site at Qingjian county, Shaanxi Province. This site has been excavated four times during 1983-1984, yielding over 3000-square meters of the remains of city walls, settlements, hoard pits, and burials. A number of bronze battle-axes, axes with tubular socket, and axe-Qi were discovered from the 40 tombs⁵⁴³. Above all, the assemblage of the potteries and bronze artifacts at the Lijiaya site is characterized by the mixture of the bronzes used with strong Shang style and local style.

In fact, a dozen sites, located in northwestern Shanxi and northern Shaanxi concentrated in the Shilou area (Map 16), have yielded such similar assemblages characterized by the rich Northern-style bronzes, together with or without the late Shang bronze ritual vessels before the excavation of the Lijiaya site (Table 34). However, most of these sites were discovered by local villagers. Therefore, the controlled excavations at the Lijiaya and Xuejiaqu⁵⁴⁴ sites provide us with a criterion for the Lijiaya culture. The sites mentioned in Table 34 are also ascribed to the Lijiaya culture by Wu E.⁵⁴⁵

The recognition of the Lijiaya culture is a cumulative and controversial process. The earliest research had noted the differences between the bronzes found from the northern Shaanxi and northwest Shanxi and the Shang Dynasty in the Central Plain⁵⁴⁶. In recent research, the scholars divide the bronze objects from north Shaanxi to northwest Shaanxi into three groups: the Shang bronzes, local bronzes, and the mixture of the Shang and local bronzes⁵⁴⁷. Some researchers have not only discussed the chronology and periodization of these bronzes, but have also penetrated into the economic, social structure, and even the ancient tribes and connections with the neighboring bronze cultures⁵⁴⁸. It is worth mentioning that some scholars, represented by Zou Hen and Liu Jundu, ascribed these bronzes to the Guangshe culture instead of the Lijiaya culture⁵⁴⁹. The research of the Lijiaya culture is still more or less at the beginning, more materials, and evidence of the settlements and burials need to be supplemented.

⁵⁴³ Zhang/Lü 1988, 47-48.

⁵⁴⁴ Xu T. J. 1988, 28-37.

⁵⁴⁵ Beifangcaoyuan 2007, 142-144.

⁵⁴⁶ Zhang C. S. 1979, 271-300; Zou H. 2001d, 233-270.

⁵⁴⁷ Lü Z. R. 1987, 214-225; 1989, 75-79; Li B. Q. 1998c. 167-184.

⁵⁴⁸ Li B. Q. 1998c. 167-184.

⁵⁴⁹ Zou H. 2001D, 233-270; Liu J. D. 1993.48-59.

Site	Context	Northern style bronzes	Shang style bronzes	Reference
Erlangpo, Shilou, Shanxi	Collected from surface	Loop-headed knife; axe	Ritual vessels; Ge-dagger	SXW 1958, 36-37.
Hejiaping, Shilou, Shanxi	Collected from surface	Animal-headed dagger	Ritual vessels; Ge; arrowheads; jades	Yang S. S. 1959, 71-72.
Houlanjiagou, Shilou, Shanxi	Collected from surface	Bow-shaped objects; adzes; spatulas; axes, awls; 3 gold earrings.	Ritual vessels; Ge; arrowheads; (2 jades).	Guo Y. 1962, 33-34.
Taohuazhuang, Shilou, Shanxi	1 tomb	Tiger-shaped spade; bow-shaped object; bulbs; 13 gold ornaments;	Ritual vessels; Ge, arrowheads; (20 jades).	Xie/Yang 1960, 50-52.
Caojiayuan, Shilou, Shanxi	Collected from surface	Bell-headed sword; axe with tubular socket; spoon; tube; bow-shaped object.	Bulbs.	Yang S. S. 1981a, 79-53.
Yide, Shilou, Shanxi	Collected, in 1967	Snake-headed dagger; dagger with tubular handle; axe.		SLW 1972, 29-30.
	1 tomb, in 1969	Ge; knife; comb; adze; axe; stripe-shaped object.	Ritual vessels.	SLW 1972, 29-30.
	At Zhujiayu, 1 tomb, in 1975	Snake-headed dagger; loop-headed knife; Ge; bow-shaped object; ornament.	Ritual vessels; Ge; arrowheads.	Yang S. S. 1981a, 49-53.
Xiaxinjiao, Yonghe, Shanxi	1 tomb	2 gold earrings.	Ritual vessels; Ge.	Yang S. S. 1977, 355-356.
Niuzipo, Xin, Shanxi	Collected	Frog headed Bi-hair clasp.	Ritual vessels.	Shen Z. Z. 1972, 67-68.
Linzheyu, Baode, Shanxi	1 tomb	Bell-headed sword; axes; chariot and horse fittings.	Ritual vessels; bells; bulbs.	Wu Z. L. 1972, 62-66.
Shangdong, Ji county, Shanxi	1 tomb	Bell-headed sword; axe with tubular		JW 1985, 848-849.

		handle; animal-headed spoon.		
Gaohong, Liulin, Shanxi	1 tomb	Bell-headed sword; helmet; spears; axes; knives; bells.		Yang S. S. 1981b, 211-212.
Zhanglangou, Yanchang, Shaanxi	Collected from surface	Knives; arrowheads.	Ge; Yue; adze; chisel.	Ji N. J. 1994, 27-48.
Lijiata, Zichang, Shaanxi	Hoard		Ritual vessels.	Qi T. G. 1989
Yantou, Suide, Shaanxi	Hoard	Deer-headed knife; snake-headed dagger; adze; chisel.	Ritual vessels; Ge; Yue; arrowheads; bulbs.	Hei/Zhu 1975, 82-87.
Hourenjiagou, Suide, Shaanxi	1 tomb	Sword; knife; three-ribbed object.	Ritual vessels; Ge; arrowheads.	SDB 1982, 41-43.
Xiejiagou, Qingjian, Shaanxi	1 tomb	Snake-headed spoon; daggers.	Ritual vessels.	SXSZQTQ 1979, 71-82 Plate 67-78.
Zhuangjiagua, Qingjian, Shaanxi	Collected from surface		Ritual vessels.	SXSZQTQ 1979, 65-70 Plate 61-66.
Yangquanpo, Xin, Shanxi	Collected from surface		Ritual vessels.	Shen Z. Z. 1972, 67-68.
Siyan, Qingjian, Shaanxi	1 tomb	Snake-headed spoon; arrowheads;	Ritual vessels.	Gao X. 1984, 760-761.
Heidouzui, Chunhua, Shaanxi	4 tombs	Knives; bulbs; bow-shaped object; axes; gold ornaments.	Ritual vessels; arrowheads; bulbs.	Yao S. M. 1986, 12-22.

Table 34. Discoveries of the bronzes of the Lijiaya culture.

It is noticeable that the potteries of the Lijiaya culture have their own features, showing its uniqueness in contrast to the classical Shang and Zhou potteries (Fig. 109a), especially the flaring-mouth cooking ware-Li with short legs (Fig. 109a, 5) and oblong-body cooking ware-Yan with a flaring mouth, girdle and pouched legs (Fig. 109a, 6).

4.2.2 Periodization and chronology

As far as the relative chronology of the Lijaya culture is concerned, the scholars are unanimous in their opinions because the bronze ritual vessels of the late Shang period have been well studied and appropriately dated in most cases. It is worth noting that some of the Shang-style vessels identified in the Lijiaya culture are the same as those found at the Yinxu site, dating from the first to the third period of Yinxu, thus providing vital evidence for the relative chronology and periodization of the Lijiaya culture. Accordingly, the Lijiaya culture started roughly from the late Shang period and ended in the early Western Zhou period (about 1300-1000 BCE).

Besides, there is little disagreement amongst scholars on the periodization of the Lijiaya culture (Table 35; Table 36) owing to different opinions on the periodization of the Yinxu, which has been discussed in Chapter 1 (see Table 2). Nevertheless, Liu Jundu differs with many scholars on this issue because he regards some tombs of the Zhukaigou site as belonging to the first of the four stages in the Lijiaya culture⁵⁵⁰.

This study agrees with the designation of the Lijiaya culture rather than the Guangshe culture⁵⁵¹ as well as the chronology and periodization proposed by Zou Heng and Zhang Changshou. In addition, this study prefers to exclude some late remains of the Zhuakaigou site from the Lijiaya culture. A lack of sufficient stratigraphical evidence and comparison of the potteries are still the greatest drawbacks in the chronology of the Lijiaya culture.

Lijiaya culture	Relative date	Representative sites or groups
Stage I	Yinxu II (Wuding-Zujia 武丁-祖甲)	Hejiaping; Houlanjiagou; Niuziping; Yangquanpo; Taohuazhuang A; Xiaxinjiao.

⁵⁵⁰ Liu J. D. 1993, 48-59.

⁵⁵¹ Liu J. D. 1993, 48-59.

Stage II	Yinxu III (Bingxin-Wending 癸 辛-文丁)	Linzheyu; Yidie.
Stage III	Yinxu IV (Diyi-Dixin 帝乙-帝 辛)	Erlangpo; Taohuazhuang B.

Table 35. Periodization of the Lijiaya culture proposed by Zou Hen⁵⁵².

Lijiaya culture	Relative date	Representative sites or groups	
		Zhang C. S.	Zheng/Chen
Stage I	Yinxu I	Hejiaping; Houlanjiagou; Niuziping IV; Yangquanpo;	
Stage II	Yinxu II	Erlangpo; Taohuazhuang;	Zhujiayu, Xiaxinjiao; Zhangjiagua; Xiejiagou (Houlanjiagou)
Stage III	Yinxu III	Linzheyu; Yantou;	Hourenjiagou;

Table 36. Periodization of the Lijiaya culture proposed by Zhang Changshou, Zheng Zhenxiang, and Chen Zhida⁵⁵³.

4.2.3 Metal objects

The Lijiaya culture is also a bronze-using culture, which provides valuable evidence on the early bronze metallurgy in north-central China. The bronzes of the Lijiaya culture can be divided into three types: Shang-style, Northern-style, and mixed style.

The bronze ritual vessels identified as belonging to the Lijiaya culture (Fig. 109b, 27-32) aroused many conjectures amongst scholars. Some scholars take it for granted that the Lijiaya culture was certainly influenced by the Shang culture in the Central Plain. While some speculate that, the owners of the Lijiaya culture were the enemies of the Shang culture according to the ancient oracle inscriptions on tortoiseshells. Therefore, the powerful local leaders who were proposed as Guifang⁵⁵⁴ (鬼方) or Gufang (吾方) were probably able to plunder these ritual vessels from Shang during the war. Other scholars point out that not only oracle inscriptions, but also ancient Chinese documents recorded that the Shang once attacked Guifang⁵⁵⁵. However, no ancient records imply that the Guifang once

⁵⁵² Zou H. 2001d, 233-270.

⁵⁵³ Zhang C. S. 1979, 271-300; Zheng/Chen 1985, 27-78.

⁵⁵⁴ Guifang and Gongfang, ancient tribes recorded in Chinese documents, lived in the north of Central China.

⁵⁵⁵ <周易·即济>: 高宗伐鬼方, 三年克之。<Zhouyi·jiji>says: it took the King of Gaozong three years to overcome the Guifang. There was a period that was called Fangguo (方国), implying that there were many other tribes in north of the Central Plains. However, the other ancient tribes were rarely recorded in ancient documents; therefore, this study does not agree that the owner of the Lijiaya culture must be related to the Guifang. There are more possibilities.

invaded the Shang. The evidence surrounding the suggestion that the local people robbed ritual vessels from the Shang is therefore not adequate. Wu E. Suggests there was probably a relatively peaceful period when the Shang and so-called Guifang people communicated with each other frequently by trading⁵⁵⁶.

As for the Northern-style bronzes of the Lijiaya culture, some of them were very common around the Great Wall region and its northern areas. They consist of swords with curved handles (Fig. 109b, 1-3), helmets (Fig. 109b, 4)⁵⁵⁷, socket-handled axes (Fig. 109b, 10.13), dagger axe-Ge, weapon-Yue and Qi, snake-headed daggers⁵⁵⁸ (Fig. 109b, 4-6), sheep-headed knives (Fig. 109b, 8), loop-headed knives (Fig. 109b, 7.9), knives with a socket on the back which are regarded as weapons by Wu E. (Fig. 108b, 14.15)⁵⁵⁹, snake-headed spoons or spoons with animal figures (Fig. 109b, 25.26), bow-shaped objects (Fig. 109b, 21-23), arrowheads, horse and chariot fittings, combs, and hair clasps, and so on. As we know, animal style, socketed daggers or axes, and objects with bells are typical northern bronzes. It is worth noting that the animal style presented in the bronzes of the Lijiaya culture are mostly of full relief, which are so far the earliest works discovered in northern China. Furthermore, the motif of a snake was quite popular in the Lijiaya culture, and some scholars proposed its prototype to be a crocodile or it may have been related to some ancient religious beliefs. The chronology and styles of the Lijiaya culture as described above are also a great help in seeking the origin of the northern bronzes, which has been a topical issue since the early half of the nineteenth century.

The bronzes characterized by a mixed style from the Central Plain and Northern China are quite remarkable, including cup-Gu, cup-Dou with bell (Fig. 109b, 19), vessel-Gui adorned with straight-lines, socketed dagger axe-Ge, double-eared pots with slim collar, cup-Gong (觥) with dragon motif, vessel-Ding with 'S' shaped cloudy patterns, and cup-You (卣) with bale handle and so on⁵⁶⁰. These kind of bronzes have not been seen at the Yinsu site and other Shang sites.

Another remarkable characteristic of the Lijiaya culture is gold objects. Earrings (Fig. 109b, 17.18.20) were the most common of the 30 gold objects found. Gold bow-shaped objects comes next (Fig. 109b, 21), which are identical to the bronze bow-shaped objects in form. The tombs buried with or without gold objects and the amount of gold wares may well be related to the social status or wealth of their owners.

⁵⁵⁶ Beifangcaoyuan 2007, 158.

⁵⁵⁷ This kind of helmet is regarded as the earliest one found in northern China.

⁵⁵⁸ This is one of the representative Lijiaya culture bronzes.

⁵⁵⁹ Beifangcaoyuan 2007, 153.

⁵⁶⁰ Beifangcaoyuan 2007, 151.

In contrast to the Zhukaigou culture which is regarded as the possible precursor of the Lijiaya culture, the metallurgical technique of the Lijiaya culture seems much more prosperous, which is reflected in both quantity and quality. Despite the fact that the related metallurgical analysis is so far not available, this study is inclined to believe that the metallurgical industry of the Lijiaya culture was more developed than that of the Zhukaigou culture. Firstly, the bronzes characterized by mixed style haven't been found in the Central Plain, so they may well have been manufactured by local people. Secondly, some slag, fragments of earth mold were found at the Lijiaya site, and pottery molds were discovered near the Shilou county. All data indicates the matured and developed metallurgical techniques at that time.

4.3 Xicha culture

4.3.1 Definition and relations between the Zhukaigou culture, Lijiaya culture and Xicha culture

The excavation of the Xicha site, which lies in the Dantaizi township, Qingshuihe county, was a crucial archaeological discovery in south-central Inner Mongolia. The excavators divide the Xicha site into three periods. One tomb buried with potteries from the second period was ascribed to the Zhukaigou culture. The remains of the third period yielded 19 settlements, 132 pits, and 18 tombs together with lots of potteries, jades, stone objects, and some bronzes. Accordingly, the excavators proposed the designation of 'the Xicha culture' to the remains from the Xicha site, which is dated to the Yin and Zhou period⁵⁶¹. A few of the bronzes collected from within the Qingshuihe county, including socketed axes, daggers, and buttons (Fig. 110, 2.4.7), were ascribed to the Xicha culture as well⁵⁶². In comparison to the similar remains found at the Zhukaigou site and Yinsu site, these collected bronzes are dated to the end of the Shang period and the beginning of the Western Zhou period, roughly between 1400-1000 BCE. Thus, the so-called Xicha culture is approximately parallel to the Lijiaya culture.

As mentioned in chapter 4.2, the Zhukaigou culture is regarded as the possible precursor of the Lijiaya culture, though there is still a tiny discontinuity between them. The newly discovered Xicha culture, dated to the late Shang period, is also distributed within the range of the Zhukaigou culture. Furthermore, elements of the Zhukaigou culture identified in the second period of the Xicha site, make some scholars believe that the Xicha culture was much closer to the Zhukaigou culture rather than the Lijiaya culture.

⁵⁶¹ NMGY/QSHW 2001, 60-80.

⁵⁶² Cao J. E. 2001.

On discussing the relations between the bronze cultures in south central Inner Mongolia, two opinions need to be improved. Firstly, in previous research, the scholars are inclined to believe that the bronze ritual vessels should have appeared in northern China more or less later than that in the Central Plain. However, the communication and mutual dissemination between the Central Plain and northern China at that time was much more frequent and faster than we expected. Secondly, the traditional Chinese scholars preferred to link the owners/origins of one archaeological culture to the ancient tribes mentioned in oracle inscriptions or documents. Considering the complicated relations between the Zhukaigou, Lijiaya, and Xicha cultures, it is quite hard to distinguish their related owners based on the present evidence available.

4.3.2 Metal objects

Some bronze objects have been identified as belonging to the Xicha culture, however only briefly mentioned in the archaeological report lack corresponding graphs. They are mainly unearthed from burials, including axes, earrings, daggers, buttons, and so on (Fig. 110). In addition, the objects with socket or tubular handle are the most common form. Besides, one pottery mold was discovered at the Xicha site, providing vital evidence for the possibility of a local metallurgical industry in the Xicha culture. So far, no metallurgical analysis has been attempted. The acquaintances of the Xicha culture need further archaeological fieldwork.

4.4 Maoqinggou culture

4.4.1 Definition and distribution

In 1986, 'the Maoqinggou type' was first put forward by the excavators of the Maoqinggou cemetery who pointed out that the Maoqinggou cemetery had distinctive local characteristics, and the burial objects have sequential relationships on the basis of an in-depth research on the date, periodization, characteristics, ethnic groups and its relations with the neighboring cultures⁵⁶³.

In fact, scholars hold different opinions of the cultural ascription of the Maoqinggou cemetery. By comparing the tomb forms, mortuary practices, burial goods, animal-style patterns on bronzes, and metallurgical techniques, Wu En divided the areas from the east of the Hexi Corridor to the Yanshan region, during the Eastern Zhou period into five districts in 1992. The five districts are: 1) East of the Hexi Corridor; 2) the Qingyang and Guyuan regions; 3) the Ordos region; 4) the south of the Yinshan; 5) the Yanshan region. He stated that the five districts might have

⁵⁶³ NMGG 1986, 227-315.

belonged to different ancient tribes. Besides, the Maoqinggou, Guoxianyaozi, Fanjiayaozi, Yinniugou, Shuijiangoumen, and Hulusitai sites that are located in the south of the Yanshan region belong to the same cultural system⁵⁶⁴.

In 1993, Tian Guangjin divided the culture distributed around the Great Wall in Inner Mongolia into three types. They are: 1) the Taohongbala type, which belonged to the steppes culture; 2) the Xiyuan type, located in the front of the Baotou site, characterized by shaft graves with a side pit and related to the south of Ningxia; 3) the Maoqinggou type lying in the Daihai region, which is characterized by a mixture of pastoral, nomadic and agriculture subsistence⁵⁶⁵. Meanwhile, Lin Yun divides the northern steppe cultures in China during the Eastern Zhou period into six areas: A, northern Hebei; B, east of Yinshan; C, northeast of the Hetao region inside Inner Mongolia; D, south of Ningxia; E, the Qingyang region in Gansu; F, west of Yinshan in Inner Mongolia. Furthermore, he points out that the six areas belonged to different cultures⁵⁶⁶. However, Yang Jianhua divides the Inner Mongolia region during the Eastern Zhou period into west and east areas. In addition, she proposes a five-phase chronology for the east area that is represented by the Maoqinggou, Yinniugou, and Guoxianyaozi cemeteries⁵⁶⁷.

In 2002, Wu En not only formally put forward the designation of ‘the Maoqinggou culture’ but also made a study on its date, periodization, and connections with its neighboring cultures. This study prefers to use ‘the Maoqinggou culture’ to designate cultural remains that are similar to the Maoqinggou cemetery, because it will help us to distinguish the other cultural remains, which are also characterized by animal-style.

Situated in Liangcheng county, Inner Mongolia, the Maoqinggou cemetery yielded a larger number of burials belonging to different periods, and a dwelling area⁵⁶⁸ dated to the early Iron Age by the excavators⁵⁶⁹. In addition to the Maoqinggou cemetery, the Fanjiayaozi, Shuijiangoumen, Qiandesheng, Yinniugou, Guoxianyaozi, and Goulitou sites are also ascribed to the Maoqinggou culture by Wu En (Table 37, Map 17). Conclusively, the Maoqinggou culture is mainly located in south-central Inner Mongolia and its adjacent areas.

⁵⁶⁴ Wu E. 1992, 149-161.

⁵⁶⁵ Tian G. J. 1993, 16-22.

⁵⁶⁶ Lin Y. 1998d, 368-396.

⁵⁶⁷ Yang J. H. 2002, 157-175.

⁵⁶⁸ It has been discussed in previous chapter.

⁵⁶⁹ NMGG 1986, 227-315.

Site	Context	Bronze items	Remark
Fanjiayaozi ⁵⁷⁰ , Helingeer county, NMG	Burials	Swords, daggers, knives, awls, plaques	Fig. 093, 32-34.
Shuijiangoumen ⁵⁷¹ , Tumoteqi, NMG	1 tomb	Ge, knife, button, tube, plaque, gag bit	Fig. 097, 2-8.
Qiandesheng ⁵⁷² , Liangcheng county, NMG	Burials	Hu-vessel, chariot fitting, belt ornaments	
Yinniugou ⁵⁷³ , Liangcheng county, NMG	Burials in an east-west direction	Arrowheads, knives, buttons, hooks; iron swords, crane hacks, axes; jade	Fig. 084d.
Guoxianyaozi ⁵⁷⁴ , Liangcheng county, NMG	Burials	Knives, axes, plaques, tubes, buttons, earrings; jade	Fig. 086a-b.
Maoqinggou, Liangcheng, NMG	Burials	Weapons, tools, ornaments, horses, and chariot fittings	Fig. 085a-c.
Goulitou ⁵⁷⁵ , Xinghe county, NMG	Burial	Sword, arrowhead, button, belt hook	Fig. 097, 9-12.

Table 37. Discoveries of the bronze objects of the Maoqinggou culture.

4.4.2 Chronology, periodization, and characteristics

In addition to the burials, other archaeological remains from settlements, ash pits, and kilns in the Maoqinggou cemetery suggest that the site was occupied for a long time. The excavators proposed a four-phase chronology for the Maoqinggou cemetery from the late Spring and Autumn period to the late Warring States period. However, according to the five-phase chronology of the east area of Inner Mongolia during the Eastern Zhou period proposed by Yang Jianhua, the cultural remains in this area represented by the Maoqinggou cemetery ended around the middle Warring States because this area was ruled by the Zhao State after the late Warring States.

Based on previous research and the comparison of the bronze objects, Wu En puts forward a three-phase chronology for the Maoqinggou culture from the middle Spring and Autumn period to the late Warring States period. The first phase is

⁵⁷⁰ Li Y. Y. 1986, 222.

⁵⁷¹ Zheng R. 1965, 50-51.

⁵⁷² Gai S. L. 1986, 185-197.

⁵⁷³ NMGG 1984, 26-32; NMGY et al. 2001, 278-327.

⁵⁷⁴ NMGY 1989, 57-81.

⁵⁷⁵ Cui L. M. 1994, 473.

represented by the burials in the first phase⁵⁷⁶ of the Maoqinggou cemetery and Guoxianyaozi cemetery. It is characterized by pots with a round belly, pots with double ears, antenna-pommel swords, loop-shaped buttons, and belt ornaments with designs of double birds. It is roughly equal to the middle and late Spring and Autumn period (700-400 BCE). The second phase is represented by the burials in the second phase of the Maoqinggou cemetery and the second and third phase of the Guoxianyaozi cemetery. During this period, the pottery differs slightly in form. Meanwhile, the bronze objects, such as swords, belt buttons, and plaques with double birds are almost the same as those in the first phase. Besides, some iron swords with a deformed antenna pommel, iron swords with a loop head and iron belt hooks also appeared in this period. The Fanjiayaozi and Goulitou sites belonged to this period as well. It is approximately parallel to the early and middle Warring States period (400-300 BCE). The third phase includes the burials of the third and fourth period of the Maoqinggou cemetery and the Yinniugou cemetery. Iron objects, noticeably increased in amount, including swords, crane hooks, knives, belt hooks, and plaques decorated with tiger or double birds. However, small bronze personal ornaments, such as bird-shaped objects, animal-head-shaped objects, and tubes were scarce in this period. It is probably parallel to the late Warring States period (300-200 BCE)⁵⁷⁷. There are three radiocarbon dates gained from the Maoqinggou cemetery (Appendix). Although there does not seem to be a pattern or cluster, nevertheless they provide support for the proposed chronology summarized by scholars.

An inhabitation area of about 200X100m has been investigated, and burials consisted of the main remains of the Maoqinggou culture. By comparison, burial customs of the Maoqinggou culture were consistent throughout the period. Most burials were in rectangular earthen pit graves (Fig. 085a-c). Some burials of the Maoqinggou and Guoxianyaozi cemeteries have additional structures: a niche and a second-level ledge or second level platform. Wooden coffins or chambers were rarely used. Animal sacrifice was common.

Compared to the characteristics of the Taohongbala culture and the Yanglang culture⁵⁷⁸ in the neighbouring area, the assemblage characterized by potteries and bronze objects in the Maoqinggou culture is in particular. For example, 42 potteries from the Maoqinggou cemetery, 28 from the Guoxianyaozi cemetery, and 7 from the Yinniugou cemetery were unearthed as well as numerous pottery shards. Except

⁵⁷⁶ The periodization of the Maoqinggou and Guoxianyaozi cemeteries is in accordance with the excavators' suggestion.

⁵⁷⁷ Beifangcaoyuan 2007, 302-303.

⁵⁷⁸ The Maoqinggou, Taohongbala, and Yanglang cultures were distributed side by side in north-central China for a long time. The other two will be discussed in the following sections.

for a few sand-inclusion potteries, most of them were made of clay. Pots were the most common form found, including round-belly pots and double-eared pots (Fig. 131a). The discoveries of dwelling remains and iron objects are also the distinctive characteristics of the Maoqinggou culture.

4.4.3 Metal objects

The metal objects of the Maoqinggou culture differ over time in quantity and variety. According to the periodization proposed by Wu En, bronze objects comprised the main body of the burial goods during the first and second phase; after the third phase, iron objects increased in quantity, implying advanced metallurgical techniques. Besides, small ornaments constituted the majority of the burial goods; weapons and tools were small in quantity; and only a few horse fittings with simple forms were found, which are not seen in the Guoxianyaozi and Yinniugou burials (Fig. 131b-c).

As mentioned above, antenna pommel swords and a number of small ornaments with patterns of birds and deer were the most prominent features of the metal objects in the Maoqinggou culture. The antenna pommels constructed with patterns of two vivid birds are regarded as the typical forms in the earlier period (Fig. 131b, 1-4). However, the deformed antenna pommels formed by two loops or animal heads, was probably originated from the bird patterns (Fig. 131b, 6-9; Fig. 131c, 1).

Moreover, weapons and tools such as crane hooks, adzes, axes, and chisels that were very common in the neighboring Taohongbala and Yanglang cultures were however absent in the Maoqinggou culture. Taking into consideration the fact that there were a few discoveries of horse fittings, it is reasonable to believe that the economy of the Maoqinggou culture was probably not based on a pastoral nomadic subsistence, though a number of small ornaments show a full-bodied steppes style.

4.5 Taohongbala culture

4.5.1 Definition and distribution

‘The Taohongbala culture’ was first formally put forward by Wu En in 2002⁵⁷⁹, named after the Tonghongbala cemetery, which was scientifically excavated and yielded lots of bronze objects, including swords, crane hacks, arrowheads, awls, chisels, needles, belt buttons, loops, animal style figures, beads, plaques, and horse fittings as well as a few iron objects and gold earrings⁵⁸⁰ (Fig. 087).

As we know, the scholars were in the habit of using the designation of ‘Ordos

⁵⁷⁹ Beifangcaoyuan 2007, 323-356.

⁵⁸⁰ Tian G. J. 1976, 131-143.

bronzes’ to indicate all the bronze objects that were found in the Ordos region and its adjacent areas. In fact, an abundance of gold, silver and iron artifacts with the so-called Ordos style were also discovered. Meanwhile, with increasing archaeological discoveries, the traditional designation has been challenged and synthetic research has been carried out. In 1983, Tian Guangjin divided the cultures located in south-central Inner Mongolia from the Shang period to the Qin and Han period into three periods: 1) from the Shang period to the Spring and Autumn period; 2) early Iron Age, namely the Warring States period; 3) the Iron Age, namely the Han Period⁵⁸¹. In 1986, the book ‘鄂尔多斯式青铜器 (Ordos-style Bronzes)’ touched upon the classification, periodization, cultural characteristics, origin and related ethnic tribes of such bronzes. This was the first time that Chinese scholars made a comprehensive study on the Ordos bronzes⁵⁸². In 1997, Tian Guangjin suggested to divide the northern steppes during the late Spring and Autumn period into three archaeological cultures. They are: 1) the Shanrong culture, which is centered in Beijing and northern Hebei; 2) the Ordos bronze culture, which is located mainly in the Ordos region, south-central Inner Mongolia; 3) the Xirong culture, which is distributed in the Gansu and Ningxia regions around the Longshan. The Ordos bronze culture includes the Xiyuan type, Maoqinggou type and the Taohongbala type⁵⁸³. In 2001, Yang Jianhua pointed out that the east and west sides of the south-central Inner Mongolia region during the Eastern Zhou period differ in cultural aspects. They show great differences in burial practice and potteries though they resemble each other in metal weapons and tools⁵⁸⁴.

Considering previous research, this study will use ‘the Taohongbala culture’ to designate one late bronze culture⁵⁸⁵ distributed in the Ordos Plateau within the Hetao region (Map 18). In addition to the Taohongbala cemetery, many other sites were also confirmed as belonging to the Taohongbala culture by Wu En⁵⁸⁶ (Table 38). As we can see, all the remains were burials. So far, no settlements have been found.

Site	Context	Metal objects	Remark
Nalingaotu ⁵⁸⁷ ,	Burials	Gold: skull cup with animal	Fig. 132, 1-15

⁵⁸¹ Tian G. J. 1983, 7-24.

⁵⁸² Ordos 86.

⁵⁸³ Tian G. J. 1997b, 266-307.

⁵⁸⁴ Yang J. H. 2001, 83-98.

⁵⁸⁵ Some scholars represented by Wu En hold the view that northern China had entered the Iron Age after the middle Spring and Autumn period because iron objects became popular step by step. While Lin Yun put forward that bronze was no longer used as the major material for weapons and tools marks the end of the Bronze Age. In his opinion, the Bronze Age existed until after the Qin period though many iron objects have appeared at that time. Consequently, Wu En ascribed the Taohongbala culture to an early Iron Age culture. This study will attribute it to the late Bronze Age culture in terms of Lin Yun’s opinion.

⁵⁸⁶ Beifangcaoyuan 2007, 322-324.

⁵⁸⁷ Dai/Sun 1983, 23-30.

Shenmu, Shaanxi		patterns, tiger figure; silver: tigers, loops, swords, pole tops; bronze: buttons.	
Lijiapan ⁵⁸⁸ , Shenmu, Shannxi	Burials	Bronze: buttons, tubes, axes, loops, beads, and plaques.	Fig. 132, 16-22
Waertugou ⁵⁸⁹ , Zhungeerqi, Inner Mogolia	Burials	Bronze: figures of sheep and deer.	Fig. 133
Sujigou ⁵⁹⁰ , Zhungeerqi, Inner Mongolia	Burials	Bronze: figures of animals and animal heads, bells, pole tops; silver necklace.	Fig. 092
Aluchaideng ⁵⁹¹ , Hangjinqi, Inner Mongolia	Burials	Gold: belt ornaments, buttons, tubes, necklaces, earrings, skull top, ornaments, figures of tiger heads.	Fig. 088
Yulongtai ⁵⁹² , Zhungeerqi, Inner Mongolia	Burials	Bronze: arrowheads, knives, adzes, animal figures, ornaments, horse fittings; iron: crane hacks, horse fittings; silver: necklaces.	Fig. 091
Hulusitai ⁵⁹³ , Wulatezhongho ulianheqi, Inner Mongolia	Burials	Bronze: swords, crane hacks, arrowheads, axes, adzes, buttons, tubes, plaques, horse fittings.	Fig. 096
Xigoupan ⁵⁹⁴ , Zhungeerqi, Inner Mongolia	Burials	Gold: belt ornaments with animal patterns; silver: swords, arrowheads, belt ornaments; bronze: animal head, ornaments with animal patterns; iron: swords, horse fittings.	Fig. 089
Baohaishe ⁵⁹⁵ , Zhungeerqi, Inner Mongolia	Burials	Bronze: Dou, knives, axes, chisels, awls, bue, buttons, loops, beads, plaques.	Fig. 090
Shihuigou,	Burials	Silver: plaques, buttons,	Fig. 093, 20-

⁵⁸⁸ Dai/Sun 1983, 23-30.

⁵⁸⁹ NMGXJ 63, plate 80-83.

⁵⁹⁰ Gai S. L. 1965, 44-46.

⁵⁹¹ Tian/Guo 1980, 333-338.

⁵⁹² NMGB et al. 1977, 111-114.

⁵⁹³ Ta/Liang 1980, 11-18.

⁵⁹⁴ YKW et al. 1980, 1-11.

⁵⁹⁵ YKW 1987, 81-83.

Yijinhuoluoqi, Inner Mongolia ⁵⁹⁶		ornaments; bronze: crane heads, sheep heads, deer, and horse fittings.	31.
Nianfangqu, Dongsheng, Inner Mongolia ⁵⁹⁷	Burials	Gold: belt ornaments, earrings, tubes, beads, loops; silver loops	Fig. 094.
Ming'anmudu, Yijinhuoluoqi, Inner Mongolia ⁵⁹⁸	Burials	Bronze: axes, knives, buttons, tube, bell, loop, gag bit.	Fig. 093, 1- 19.

Table 38. Discoveries of the metal objects from the Taohongbala culture.

4.5.2 Chronology and periodization

Scholars still have disputes over the chronology and periodization of the Taohongbala culture. As proposed by Tian Guangjin, it should fall between the late Spring and Autumn period and the Warring States period. However, Yang Jianhua suggests that it should fall from the early or middle of the Spring and Autumn period to the Qin period on the basis of the object assemblages and radiocarbon dates available (Appendix). While some scholars question not only the radiocarbon dates but also the iron objects found.

This study agrees with Wu En's suggestion, that the Taohongbala culture started from the middle Spring and Autumn period and ended at the end of the Warring States period (700-200 BCE). Firstly, the radiocarbon date obtained from tomb M1 of the Taohongbala cemetery is cal. 848-400 BCE (Appendix), indicating that this tomb would not be earlier than the middle Spring and Autumn period. Secondly, the Ming'anmudu tombs are probably earlier than the Taohongbala cemetery because the socketed axe found at Ming'anmudu (Fig. 093, 1) was also seen in one tomb at Shanbiao town, Hui county, Henan Province which was dated between 300-240 BCE⁵⁹⁹. Thirdly, the gold and silver objects found at Shihuigou (Fig. 093, 20-31) and Nianfangqu (Fig. 094) show strong features of the Warring States period, especially the animal patterns. As stated by Wu En, the appearance of the gold, silver, and iron objects cannot be regarded as enough evidence for dating them into the Qin or Han period, because the iron objects appeared quite early in the adjacent Maoqinggou culture and Yanglang culture⁶⁰⁰. Furthermore, some typical metal objects found at Nianfangqu and Shihuigou are absent in the Qin and Han period,

⁵⁹⁶ YKW 1992, 91-96.

⁵⁹⁷ YKW 1991, 405-408.

⁵⁹⁸ YKW et al. 1992, 79-81.

⁵⁹⁹ GBJ 59, Plate 26, 5.

⁶⁰⁰ The Yanglang culture will be discussed in the next section.

which is regarded as the golden age of the Xiongnu people.

Due to a lack of sufficient stratigraphical evidence and standard objects, it is hard to make a detailed periodization for the Taohongbala culture. However, on the basis of the assemblages of burial goods and in contrast to the Maoqinggou culture, it can be still roughly divided into two periods. Ming'anmudu, Baohaishe, Shuijiangoumen, Taohongbala, Hulusitai, and Tomb M3 of Xigoupan are probably a little bit earlier because the bronze swords, crane hacks, belt buttons, animal shaped figures, tubes and so on are similar to those of the first phase of the Maoqinggou culture, roughly parallel from the middle Spring and Autumn period to the early Warring States period. The other cemeteries, such as tomb M2 of Xigoupan, Aluchaideng, Yulongtai, and Nalin'gaotu may be a little bit later because iron objects as well as gold and silver objects increased remarkably .

In contrast to the Maoqinggou culture, the Taohongbala culture has its own peculiar traits: 1) less pottery was found; 2) so far, no remains of a settlement have been discovered; 3) gold and silver objects were much advanced; 4) horse and chariot fittings were more prosperous than those in the Maoqinggou culture.

4.5.3 Metal objects

4.5.3.1 Types

The metal objects of the Taohongbala culture are bounteous and varied. In light of the raw material, they can be classified as bronze, gold, silver, and iron. Bronze objects present a strong nomadic style, including weapons, tools, horse and chariot fittings, and ornaments. Of them, the antenna pommel swords that were very typical in the Maoqinggou culture (Fig. 131b, 1-6) are relatively few in the Taohongbala culture (Fig. 134a, 1-3; Fig. 132, 23). However, the knives are much richer in quantity and forms (Fig. 134a, 6-8) than in the Maoqinggou culture (Fig. 131b, 39). The tubes are similar in patterns and shapes to those in the Maoqinggou culture (Fig. 134a, 14-16; Fig. 131b, 32-36). One bronze axe with a brush on the handle is attractive though its function is not clear (Fig. 134a, 9). Compared to the Maoqinggou culture, more horse masks (Fig. 134a, 54.55.57) and pole tops (Fig. 134a, 40, 42-45.48.49) were found in the Taohongbala culture. In addition, the ornaments were splendid and rich in patterns and forms (Fig. 134a, 21-39).

The Taohongbala culture is famous for the great number of splendid gold and silver objects (Fig. 134b-e). The Aluchaideng, Xigoupan, Nianfangqu, Shihuigou, and Nalingaotu cemeteries produced many gold and silver artifacts, a testimony to the exquisite metallurgical techniques used at that time. For example, the delicate gold crown with a headband (Fig. 134d) is striking and amazing, showing high skill.

Gold and silver belt ornaments, ornament sheets, necklaces, earrings, and eardrops were quite common in the burials (Fig. 134c).

As we know, iron objects are hard to preserve because of corrosion. Nevertheless, a considerable quantity of iron objects were also found in the Taohongbala culture, including swords, crane hacks, knives, awls and so on. The iron sheath found at the Xigoupan cemetery is coated with gold sheets and animal designs (Fig. 134a, 19). One sword handle found at Nalingaotu (Fig. 132, 1) is very characteristic, with a silver coat inlaid with gold decorations, implying highly skilled metalwork at that time.

The so-called Ordos bronzes are well known for their splendid animal patterns and designs, which are fully manifested in the metal objects of the Taohongbala culture. The designs and patterns include prey attacking herbivorous animals (Fig. 134b, 2; Fig. 134c, 18; Fig. 134d, 1-3), animals in combat (Fig. 134b, 1;), animals in a standing or crouching position (Fig. 134d, 4; Fig. 134c, 2.5.8.17; Fig. 134a, 21.25), full-relieved animals (Fig. 134a, 40-49), and fictional animals (Fig. 134c, 19.20; Fig. 134d, 5). Many images of animals were included such as tigers, leopards, wolves, deer, antelopes, hedgehogs, eagles, cranes, birds, horses, oxen, sheep, dogs and so on, indicating a vivid nomadic lifestyle.

The influence from the Central Plain is reflected in metal objects as well. For example, bronze and iron horse masks were found at the Taohongbala cemetery and Dou-vessels (Fig. 134a, 50, 51) were discovered at the Baohaishe site. Besides, the Chinese characters were engraved on gold and silver objects which were unearthed from the Xigoupan cemetery (Fig. 089, 35). All data indicate close relations between northern and central China.

4.5.3.2 Metallurgical analysis

In previous research, all of the animal style bronzes found in the Ordos region and its adjacent areas are called 'Ordos bronzes'. The earliest composition analysis of the Ordos bronzes was undertaken by Japanese scholars in 1932. A total of 11 objects including mirror, sword, axe, knife, Fu-cooking ware, belt buckles and so on were examined⁶⁰¹. In 1965, sponsored by the Sackler Fund, W. Samolin Isabella and M. Drew made a study on 91 bronze objects from the Sackler collections. It was devoted solely to the composition of the alloys and trace element patterns. The results showed that: 1) 50 plaques of a wide geographic base dating stylistically from the Spring and Autumn period to Han (403 BCE-AD 220) were tabulated; 2) Pb, Ag, Sn, Zn and Cu were determined calorimetrically or complexometrically; 3)

⁶⁰¹ Egami Namio/Mizunari Seiichi 1935.

trace elements, such as Al, As, Au, Bi, Ca, Co, Cr, Fe, Mg, Mn, Ni, Sb, Si, Ti were observed⁶⁰². At that time they stated: ‘Although we believe the greater part of the material to be authentic, the aforementioned bronze objects that have been analyzed do not, to our knowledge, contain any pieces obtained by a controlled archaeological excavation’.

In 1996, Chinese scholars made a metallurgical research on the so-called Ordos bronzes that were found from Inner Mongolia. This involves composition analysis, metallographic structure, and manufacturing techniques⁶⁰³. A total of 15 bronze objects from the Zhukaigou site which was excavated with clear stratigraphical evidence and chronological information, and 20 objects collected from the Yikezhaomeng region were determined. The information obtained is as follows:⁶⁰⁴ (Table 39; Table 40; Table 41):

1. The chemical composition of these bronzes. 6 of the 35 artifacts are brass. Of the other 29 bronzes, 1 is determined to be copper, 28 objects to be tin copper alloys and tin lead copper alloys (Table 39).

2. Metallurgical structure. 8 of the 35 objects contain less than 2% Pb. 7 objects contain 3-19% Sn, and most of their metallurgical structure shows a pure and tight texture with tiny impurity. In addition, 17 objects contain over 20% Sn and show a cast structure. 18 objects, mainly ornaments and vessels, have obvious alloy segregation of dendrite-like grains. Besides, a section distributed with slip lines, α equiaxed crystals, and twin crystals indicate that it may have been partially cold and hot worked after cast. Such items are in 8 cases. Most of them are weapons and tools.

3. Of the 6 brasses, 4 are Cu-Pb-Zn alloys and 2 are Cu-Sn-Pb-Zn alloys. Their metallurgical structure is α or $\alpha+\beta$ casting structure, containing 0.5-1.6% Fe. It is worth mentioning that sample E.1601, a bronze figure of a human riding a horse, contains even 1% Ni.

4. About half of these bronze objects contain over 1% Mg-compound or 1% chloride. It may have been caused by corrosion from being buried in alkaline soil.

As we can see in Table 40 and Table 41, 4 of the 6 brasses contained over 30% Zn, indicating that they were not accidentally produced from paragenetic mineral or

⁶⁰² Salmolin/Drew 1965, 170-183.

⁶⁰³ Han/Li 1996, 104-114.

⁶⁰⁴ Information on the bronze objects of the Zhukaigou site has been discussed in the preceding section on the Zhukaigou culture.

mixed ore⁶⁰⁵. As for the trace elements, over 0.1% Si, Al, Mg, Cl, As, Fe, Sn, Ni, Pb, Ag have been identified. Of them, Si, Al and Mg may be interfused from the changing material. While As, Sn, Ni, Ag with a content of over 1%, may provide vital clues for finding out the raw materials used for the alloy bronzes. In addition, a high content of Ag in some objects from the Zhukaigou site implies distinct local characteristics.

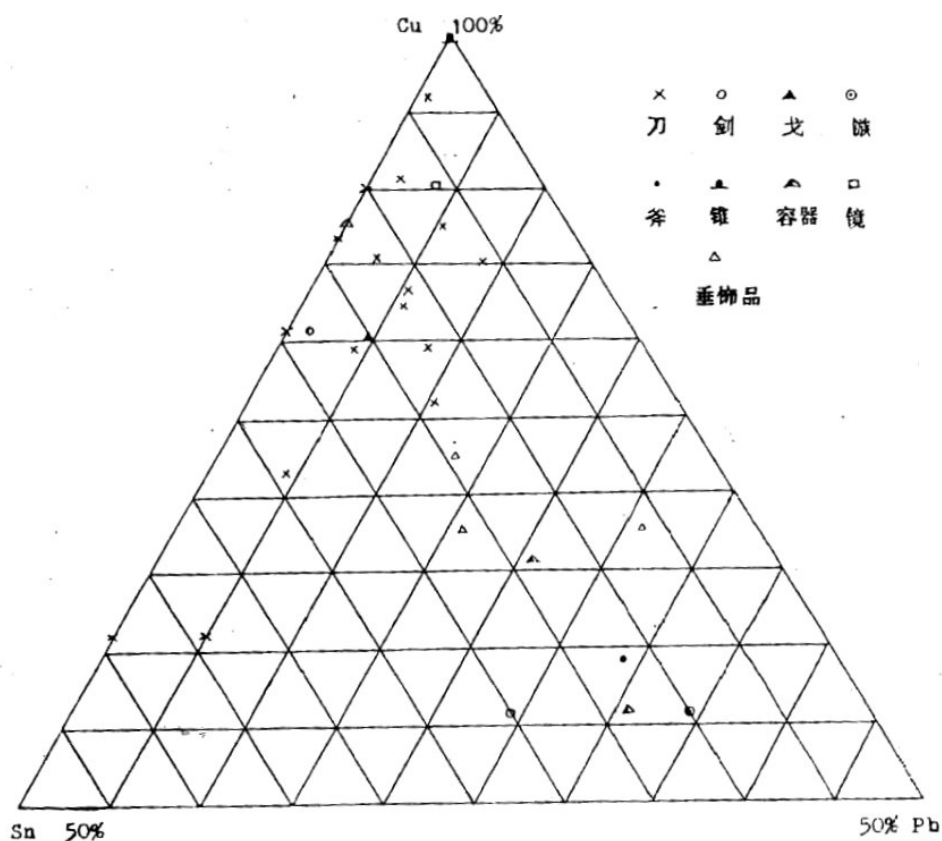


Table 39. Chemical component of the Ordos bronzes, 刀-knife; 劍-sword; 戈-Ge; 鏃-arrowhead; 斧-axe; 錐-awl; 容器-vessel; 鏡-mirror; 垂飾品-pendant ornament (after Han/Li 1996, 105).

⁶⁰⁵ Han/Li 1996, 111.

Lab. No.	Sam. No.	Object	Chemical composition (%)						Scanning method	Metallographic structure	Remark
			Cu	Sn	Pb	Fe	Zn	Ni			
2652	E.1639	mirror	89.3 83.6 95.0	6.9 12.3 3.6	3.2 3.4 1.0	— 0.4 Cl —	— — —	— — —	FF SF A, B	There are distinctive dendrite-like segregation of α solid solution; A spot is α structure containing Pb, Sn and Cl; B spot is α structure with trace Sn and Pb	Cu-Sn-Pb, cast
2658	E.1658	Jieyue	60.9	—	2.8	0.5	35.5	—	FF	There are α solid solution and dendrite-like distributed δ structure.	Cu-Zn-Pb, cast
2659	E.1659	Jieyue	60.7	0.7	5.8	0.9	31.4	—	FF	There are α solid solution and some δ structures; Pb particles are scattered.	Cu-Zn-Pb, cast
2660	E.1501	tiger figure	67.5	15.8	16.6	—	—	—	FF	There are distinctive dendrite-like segregation of α solid solution, many (α + δ) eutectoids, uneven Pb particles, inclusions composed of Cu and S.	Cu-Sn-Pb, cast
2661	E.1502	elephant figure	66.7	5.9	25.6	1.7Cl			FF	There are distinctive dendrite-like segregation of α solid solution, a few of (α + δ) eutectoids, many Pb particles which are strip-like, lump-like or dendrite-like distributed, many sulphide inclusions containing Cu.	Cu-Sn-Pb, cast
2662	E.1503	elephant figure	72.1	14.1	13.5	0.2Cl			FF	dendrite-like segregation of α solid solution is obscure; there are a few of (α + δ) eutectoids, Pb particles and sulphide	Cu-Sn-Pb, cast

											inclusions containing Cu.	
2653	E.1601	riding human figure	71.5 72.7 72.9 37.4	5.2 3.1 6.9 20.3	3.2 3.8 2.3 35.9	1.6 2.3 0.9 —	17.0 17.0 16.4 4.1	0.9 0.8 0.1 1.0	FF SF A B C	There are distinctive dendrite-like segregation of α solid solution and a few of (α + δ) eutectoids; A spot is α brass containing Pb, Fe, Ni, Sn; B spot is α brass containing much Sn and few Fe; C spot is the second image.	Cu-Sn-Pb-Zn, cast	
2656	E.1602	riding human	58.4	0.3	6.3	1.4	33.3		FF	There is distinctive casting dendrite-like segregation; it is (α + δ) brass together with a few Pb particles.	Cu-Zn-Pb, cast	
2654	E.1612	human figure	56.3	—	6.2	1.5	35.5	—	FF	(α + δ) brass contains few Fe; there are distinctive casting dendrite-like crystals, which are even.	Cu-Zn-Pb, cast	
2657	E.1585	human figure	67.4	6.0	10.8	—	14.7	—	FF	There is distinctive dendrite-like α solid solution which is (α + δ) brass containing much Sn.	Cu-Sn-Pb-Zn cast	

Table 40. Results of the metallurgical analysis of the Ordos bronzes, FS: flat plane scanning method; SS: spot scanning method (adapted from Han/Li 1996, 108 Table 2).

Lab. No.	Sam. No.	Object	Chemical composition (%)					Metallographic structure	Remark
			Cu	Sn	Pb	Fe	Mg		
2648	E.10	knife	77.8	11.2	9.3	—	—	There are distinctive segregation of α solid solution, a few (α + δ) eutectoids, dendrite-like Pb particles, and partially distributed α isometric crystals and twin	Cu-Sn-Pb, cast, partial hot working

								crystals	
2649	E.13	knife	79.1	16.8	4.0	—	—	There are α isometric crystals and twin crystals, a few ($\alpha + \delta$) eutectoids; Pb particles are distributed in the processing direction; some slip lines are located in the edge of the blade.	Cu-Sn-Pb, hot working
2650	E.14	handle of knife	85.7	5.5	8.8	—	—	There are α isometric crystals and twin crystals, Pb which are dendrite-like, lump-like or particle-like distributed; a few sulphide inclusion contains Pb.	Cu-Sn-Pb, hot working
2680	E.27	knife	85.3	8.8	—	<0.1	4.8	There are distinctive dendrite-like segregation of α solid solution, a few ($\alpha + \delta$) eutectoids, shrinkage cavity and pores; structure in the edge of blade is elongated in the processing direction.	Cu-Sn, cast, partial cold working
2677	E.53	knife	73.0	13.5	9.6	>0.1	2.8	There are distinctive segregation of α solid solution and partial thin α isometric crystals and twin crystals, dendrite-like or particle-like Pb, sulphide inclusion containing Pb.	Cu-Sn-Pb, cast, cryogenic metal-working
2649	E.111	knife	81.0	10.2	5.1	<0.1	3.1	α isometric crystals and twin crystals; Pb is distorted in the processing direction; some cold-working slip lines are distributed in the edge of sample; a few of light grey, blue gray inclusions.	Cu-Sn-Pb, hot working, partial cold working
2651	E.113	knife	87.3	7.2	5.5	—	—	There is distinctive dendrite-like segregation of α solid solution; α isometric crystals and twin crystals are partially distributed together with a few Pb grains.	Cu-Sn-Pb, cast, partial hot working
2678	E.116	knife	82.5	11.2	1.8	0.5	3.5 1.1Ag	There is distinctive dendrite-like segregation of α solid	Cu-Sn, cast, partial cold

								solution, many ($\alpha + \delta$) eutectoids; edge of the sample is rusty, located some sulphide containing Pb, Cu, Fe; the point of the knife is distorted because of cold working.	working
2675	E.117	handle of knife	86.1	13.6	<0.1	0.3	—	There is dendrite-like segregation of α solid solution, many ($\alpha + \delta$) eutectoids, a few casting loosen structure.	Cu-Sn, cast
2676	E.137	knife	80.7	18.9	<0.1	—	—	There is distinctive dendrite-like segregation of α solid solution, many ($\alpha + \delta$) eutectoids, a few of casting shrinkage cavities.	Cu-Sn, cast
2681	E.194	knife	91.9	8.2		0.5	—	There is fine distinctive dendrite-like segregation of α solid solution, relative pure; many casting shrinkage cavities.	Cu-Sn, cast
2682	E.1	sword	62.1	13.7	19.3	—	2.5	There is distinctive dendrite-like segregation of α solid solution, a few ($\alpha + \delta$) eutectoids, dendrite-like and particle-like Pb, and casting flaw	Cu-Sn-Pb, cast
2663	E.228	axe	58.4	12.5	28.0	—	—	Dendrite-like segregation of α solid solution is obscure, few tiny ($\alpha + \delta$) eutectoids; Pb are dendrite-like, lump-like, particle-like distributed, together with some fine sulphide inclusions; some slip lines caused by cold working are located in the edge.	Cu-Sn-Pb, cast, cold working

Table 41. Results of the metallurgical analysis of the Ordos bronzes (adapted from Han/Li 1996, 106-107 Table 1).

4.6 Yanglang culture

4.6.1 Definition and distribution

Increasing archaeological discoveries centered roughly around the Longshan in the Gansu and Ningxia regions, have aroused great interest amongst scholars for a long time. However, the designation of the remains characterized by metal horse fittings and weapons with animal styles, which are similar to the so-called Ordos bronzes in this region, have long been disputed.

In 1985, Zhong Kan first questioned the traditional address of ‘the Xiongnu culture’ regarding the archaeological remains found in the south of Ningxia on the basis of a comprehensive study on the classification, characteristics, chronology, and ethnic attribution of the bronze objects⁶⁰⁶. In 1993, Xu Cheng and Li Jinzeng titled the cultural remains distributed from the Yinshan and Ordos regions to the south of the Ningxia and Qingyang regions of Gansu as ‘Rongdi (戎狄) bronze culture’. In addition, the former centered in the Yinshan and Ordos region, is classified as ‘the Maoqinggou type’, belonging to the Di (狄) people; the latter centered on the south of Ningxia and the Qingyang region of Gansu is classified as ‘the Yanglang type’, owned by the Rong (戎) people⁶⁰⁷. After the excavations at Mazhuang and Yujiazhuang in the Guyuan county, some scholars put forward the designation of ‘the Xirong culture’⁶⁰⁸, ‘the Yanglang bronze culture’⁶⁰⁹ and ‘the Loss Plateau bronze culture’⁶¹⁰.

Considering the dispute on the ethnic attribution, and on the difference of the remains distributed in the Ordos and Yinshan regions, this study will use the ‘Yanglang culture’ which was put forward by Wu En⁶¹¹ to designate the remains characterized by Ordos-style metal objects, distributed mainly in south central of Ningxia and the eastern part of Gansu (Map 19).

In addition to the Mazhuang cemetery in the Yanglang township, some other sites⁶¹² were confirmed as belonging to the Yanglang culture as well (Table 42), mainly in the south of the Ningxia and Qingyang regions in Gansu.

Site/location	Contexts	Metal objects (most of them are made of bronze)	Remarks
---------------	----------	---	---------

⁶⁰⁶ Zhong/Han 1985, 203-231,

⁶⁰⁷ Xu/Li 1993, 1-11.

⁶⁰⁸ NXY 1995, 105.

⁶⁰⁹ NXY et al. 1993, 13-56.

⁶¹⁰ Xu/Li 1993, 1-11.

⁶¹¹ Beifangcaoyuan 2007, 357-360.

⁶¹² The metal objects of these sites have been discussed in chapter 2.2.

Langwozikeng ⁶¹³ , Zhongwei county, Ningxia	11 burials	Over 400 pieces of bronzes: weapons, tools, ornaments, horse fittings; some iron swords	Fig. 021
Zhangjie village ⁶¹⁴ , Pengyang county, Ningxia	Over 10 burials	Bronzes: weapons, horse fittings, tools, ornaments; and some iron swords, loops.	Fig. 022a
Miyuan village ⁶¹⁵ , Pengyang county, Ningxia	1 tomb	Bronzes: swords, spears, arrowheads, axes, knives, adzes, horse fittings, small ornaments.	Fig. 023
Xianma village ⁶¹⁶ , Pengyang county, Ningxia	1 tomb	72 pieces of bronzes: swords, spears, axes, adzes, awls, crane hacks, horse fittings.	Fig. 024
Guantai village ⁶¹⁷ , Pengyang county, Ningxia	Collected from 1 tomb	Over 30 pieces of bronzes: Ge, spears, knives, arrowheads, pole tops, bells, plaques, horse fittings; some iron swords.	Fig. 025
Baicaowa villag ⁶¹⁸ , Pengyang county, Ningxia	Collected from burials	17 pieces of bronze: spear, Dun, crane hacks, bulbs, pole tops.	Fig. 026
Baicha village ⁶¹⁹ , Pengyang county, Ningxia	Collected from burials	14 pieces of bronzes: Ge, Dun, shaft of cart, bells, plaques.	Fig. 027
Dianwa village, Pengyang county, Ningxia	Collected from burials	25 pieces of bronzes: Dun, shaft of cart, gag bits, bulbs, pole tops, figures of deer.	Fig. 028
Chenyangchuan village ⁶²⁰ , Xijie county, Ningxia	2 tombs	Bronze ornaments and horse fittings; iron swords; silver Jieyue and plaques.	Fig. 030; Fig. 031
Wugou ⁶²¹ , Longde county, Ningxia	burials	Bronze arrowheads, plaques, figures.	Fig. 032, 1-8
Niding village ⁶²² , Zhongning county, Ningxia	2 tombs	Bronze: swords, socket axes, axes, arrowheads, knives, horse fittings; gold plaques.	Fig. 033
Xijiao ⁶²³ , Guyuan	Collected	Bronze: horse fittings, plaques, bulbs, crane	Fig. 034

⁶¹³ Zhou X. H. 1989, 971-980.

⁶¹⁴ NXY et al. 2002, 14-24; Yang/Qi 1999, 28-37.

⁶¹⁵ Yang/Qi 1999, 28-37.

⁶¹⁶ Yang/Qi 1999, 28-37.

⁶¹⁷ Luo/Yan 1993, 17-21.

⁶¹⁸ Yang/Qi 1999, 28-37.

⁶¹⁹ Yang/Qi 1999, 28-37.

⁶²⁰ Yan/Li 1992, 573-575.

⁶²¹ Wang J. Q. 1990, 5-7.

⁶²² Zhong K. 1987a, 773-777.

⁶²³ Zhong K. 1978, 89.

county , Ningxia	from tombs	hacks.	
Yangwa ⁶²⁴ , Guyuan, Ningxia		Bronze: swords, Ge, knives, axes, chisels, belt buckles, plaques, horse fittings.	Fig. 035
Dabeishang ⁶²⁵ , Yanglang, Guyuan county, Ningxia	1 tomb	Bronze: spears, knives, horse fittings, pole tops, plaques	Fig. 036
Wangjiaping ⁶²⁶ , Guyuan county, Ningxia	1 tomb	69 pieces: bronze spears, bells, tubes, plaques, figures of falcon; iron tools.	Fig. 037
Lüping ⁶²⁷ , Guzuan county, Ningxia	1 tomb	75 pieces of bronzes: spears, Ge, bells, horse masks, plaques, buckles, figures of relief deer.	Fig. 038
Samen, Nianjiao, Siyingshuiku, Sanying, Mengyuan, Shangtai ⁶²⁸ , Ningxia	Burials and collected	Bronze: weapons, tools, horse fittings, ornaments.	Fig. 040
Mazhuang , Guyuan county, Ningxia	49 tombs	743 metal objects, bronze: weapons, tools, ornaments, horse fitting; iron: swords, knives, gag bits, chisels, loops, plaques; gold earrings; silver earrings	Fig. 041b-e.
Yujiazhuang ⁶²⁹ , Guyuang , Ningxia	28 tombs	Bronze: weapons, tools, ornaments, horse fittings; iron: swords, plaques, ornaments; gold plaques.	
Wujiagouquan, Yuanjia, Houzhuang, Miaoqu, Hongyan, Wulipo ⁶³⁰ , Qingyang, Gansu	burials	Bronze: weapons, tools, horse fittings, ornaments; iron swords with bronze handle; silver earrings	Fig. 057-061
Mazhai, Ligou, Tatou, Fengbao ⁶³¹ , Qingyang, Gansu	burials	Bronze: swords, spears, knives, belt ornaments, deer figures, tubes, joint beads.	Fig. 062
Wangjia, Qin'an county ⁶³² , Gansu	burials	Bronze: swords, knives, tubes, joint beads.	Fig. 067

Table 42. Discoveries of the metal objects from the Yanglang culture.

⁶²⁴ Zhong/Han 1985, 204; Luo F. 1983, Plate 25.

⁶²⁵ Zhong/Han 1985, 205.

⁶²⁶ Zhong/Han 1985, 203-231.

⁶²⁷ GYB 1992, 469-470.

⁶²⁸ Luo/Yan 1993, 17-21,

⁶²⁹ NXY 1995, 79-106; Yan S. Z. 1994, 94-96.

⁶³⁰ Liu/Xu 1988, 413-424.

⁶³¹ Liu/Xu 1988, 413-424.

⁶³² Xu/Guo 1986, 40-42.

4.6.2 Chronology, periodization, and relations with the neighboring cultures and others

Based on the three-phase periodization from the middle Spring and Autumn period to the middle Warring States put forward by Luo Feng⁶³³, Wu En suggests one more detailed three-phase periodization from the early and middle Spring and Autumn period to the middle and late Warring States period for the Yanglang culture as well⁶³⁴. The early phase is represented by the Langwozikeng cemetery which is dated to the early and middle Spring and Autumn period (800-500 BCE) because the socket daggers (Fig. 021, 17-20) are regarded as the prototype of the crane hacks, which became popular in the later period. Furthermore, loop-headed swords and gag bits show features in their earlier development. In addition, the Niding village is also attributed to the early phase. The middle phase is recognized by the earlier tombs of the Yujiazhuang and Majiazhuang cemeteries (A group)⁶³⁵, and the accompanying metal objects display great similarities to those found at the Taohongbala, Maoqinggou and Guoxianyaozi cemeteries. The antenna swords, belt buckles, tubes, and figures of birds were dated from the late Spring and Autumn period to the early Warring States period (ca. 500-400 BCE). The late tombs of the Mazhuang cemetery (B group) fall into the late phase of the Yanglang culture because horse and chariot fittings and iron objects increased in number when compared with A group. Furthermore, the Baiyanglin village, and Chenyangchuan village are also attributed to this period as the animal-style patterns, such as tigers biting sheep, duck heads and so on imply a style of the later period. The late period is roughly parallel to the middle and late Warring States period (ca. 400-200 BCE).

So far, no settlement sites which are contemporary with the burials of the Yanglang culture have been reported. As for the burials, in addition to the usual earthen pit graves, the vertical rectangular pit graves with a side pit at the base into which the body of the deceased was placed were quite popular (Fig. 041a). This burial structure was also very common in northwestern China during the Neolithic and Bronze Age, especially in the Shajing culture. A few of them are even seen in the Zhangjiapo, Liujiacun and Nianzipo cemeteries⁶³⁶, implying that the owners may have entered the Central Plain.

Pottery was very scarce in the Yanglang culture. For instance, only 4 pieces of pottery were found from the 49 tombs at Mazhuang, and only 7 were discovered from the 29 tombs at Yujiazhuang. Most of the potteries were plain pots with single or double ears

⁶³³ Luo F. 1993, 29-49.

⁶³⁴ Beifangcaoyuan 2007, 361-362.

⁶³⁵ The remains of the Mazhuang cemetery is divided into A and B two groups: A is ascribed to the earlier stage of the Mazhuang cemetery, B is attributed to the later stage.

⁶³⁶ Beifangcaoyuan 2007, 365.

as well as a few spoons and cups (Fig. 135a).

The Yanglang culture was located west of the Ordos region where the Taohongbala culture disseminated (Map 17). They resembled themselves not only in animal sacrifices such as horses, cattle, and sheep, but also in animal-style patterns and objects, including antenna-pommel swords, crane hacks, belt buckles, tubes, figures of birds, joint beads, and plaques with varied animal patterns. Meanwhile, they differed themselves in the form of the tomb structure used: the Yanglang culture is recognized by vertical earthen pit graves with a side pit; while the Taohongbala culture is characterized by earthen shaft graves. Not only some burial goods including iron swords with a bronze handle and some kinds of bronze spears and pole tops, but also some animal patterns such as a tiger biting a sheep and deer motifs were also not seen or were scarce in the Taohongbala culture. It is also hard to judge which culture was in a much stronger situation at that time. The cultural characteristics that the Yanglang culture shares with the Taohongbala culture are so prominent that they led Tian Guangjin to conclude that the Yanglang culture were remains of the so-called 'Xiongnu culture' centered in south-central Inner Mongolia⁶³⁷. However, other scholars attribute the Yanglang culture to the Yiqu (义渠)⁶³⁸ or the Yuezhi (月氏)⁶³⁹. Until now, no opinion on the ethnic attribution of the Yanglang culture has been largely accepted amongst scholars. No matter which historic group produced these remains, the Yanglang culture seems to have emerged at the same time as the Taohongbala culture. There was probably a sudden increase in pastoral nomadic activity in southern Ningxia and south-central Inner Mongolia⁶⁴⁰.

As mentioned in pervious chapters, the vertical earthen pit graves with a side pit were very common in the Shajing culture (Fig. 098a-098f; Fig. 065a-065h) which is an earlier bronze culture distributed in middle-eastern Gansu, and produced lots of bronze horse fittings and ornaments. It may be the possible origin of the Yanglang culture.

4.6.3 Metal objects

Compared to the other contemporary bronze cultures distributed central and east of the Northern Zone, the metal objects of the Yanglang culture lack the bronze ritual vessels of the Central Plain style.

As for the bronze objects, they consist of weapons, tools, horse fittings, and personal ornaments, characterized by local features. The loop-headed swords and antenna

⁶³⁷ Tian G. J. 1983, 7-14.

⁶³⁸ Zhong/Han 1985, 203-231.

⁶³⁹ Luo F. 1990, 743-750.

⁶⁴⁰ Pak Y. J. 1996, 256-257.

pommel swords which were also seen in the Taohongbala culture and the Maoqinggou culture were very common (Fig. 135b, 1-8) in the Yanglang culture. The socketed end of the bronze spears seems to be connected to the wood handle (Fig. 135b, 10.11). Only a small quantity of axes were found. It is worth mentioning that the crane hacks with a round or oval socket and two-axe-shaped ends (Fig. 135b, 18.25.28) were regarded as the prototype of the crane hacks with one-crane-shaped end. In addition, over one hundred pieces of tubes in length from one to twelve centimeters were unearthed, decorated with patterns of dog's legs, spirals, raised lines, triangles, semicircles, ears, diamonds, and so on (Fig. 135b, 19-24). These tubes were probably used as boxes for needles or chisels. In addition, chariot and horse fittings were quite advanced in quantity and quality, especially gag bits, darts, Danglu, shafts of dart, pole tops, and bells (Fig. 135c, 1-14). Finally, the Yanglang culture was exceedingly rich in the personal ornaments. Over 400 belt ornaments were discovered (Fig. 135c, 15-23; Fig. 135d, 11-16.20-22.28.29), characterized by patterns of a single bird, two birds, four birds, deformed birds and animals in combat. The plaques decorated with animals in combat may have been used to decorate the belt (Fig. 135c, 15-23). The decoration on the belt buckles is also quite complicated and varied (Fig. 135d, 1-3.6-8.19), including nipple patterns, trellis designs, raised lines, curved lines, ear patterns, and so on. So far, the spade-shaped plaques of the Yanglang culture (Fig. 135d, 17) have not been found in other regions.

There were also a great number of iron objects found in the Yanglang culture, including swords, spears, gag bits, darts, belt ornaments, loops, awls, plaques, and armlets (Fig. 135d, 48-54). In the earlier phase of the Yanglang culture, only some iron swords with a bronze handle occurred. After the middle phase, iron objects increased gradually both in number and forms. Iron swords with a bronze handle are one of the most remarkable characteristics of the Yanglang culture. Such a bronze handle is a mushroom-shaped pommel, decorated with cord patterns or nipple patterns in the body of the handle (Fig. 135b, 9). According to the opinion of Wu En, such iron swords may have originated from the west of the Eurasian Steppe⁶⁴¹.

The decorative art of the Yanglang culture is quite splendid, reflected richly in the openwork carving and relief techniques used on the bronze objects. The decorative images include tigers, deer, horses, camels, sheep, falcons, birds and dogs. The forms include animal heads or bird heads decorated on swords or ornaments, plaques in the shape of standing animals, animals in combat, prey attacking herbivorous animals, relief deer, dogs, and humans riding on horses or camels (Fig. 135d, 38-47), implying a strong pastoral nomadic life at that time.

⁶⁴¹ Beifangcaoyuan 2007, 375.

A small number of gold and silver objects were also found in the Yanglang culture. Information on metallurgical analysis is not available. However, judging from the abundant glorious metal objects found so far, we can infer that the metallurgical techniques used in the Yanglang culture were considerably well developed.

4.7 Summary

It is worth mentioning that there are two discontinuities in the cultural development of the North-central Complex (Fig. 136), though the earlier and later bronze cultures show certain relations and succession.

The first small discontinuity appears between the Zhukaigou culture, the Lijiaya culture, and the Xicha culture, roughly during the transitional time between the early and late Shang period (about 1300-1200 BCE). Some scholars suggest that the formation of the Lijiaya culture was caused by the southwards spreading of the Zhukaigou culture, in light of some similarities in the pottery assemblage and style of the dwelling place⁶⁴². As mentioned in chapter 4.3, the Xicha culture was much closer to the Zhukaigou culture than the Lijiaya culture was. In fact, both the Lijiaya and Xicha cultures were newly identified in recent decades, so the recognition of some cultural aspects needs to be improved. Until now, the archaeological materials were not sufficient to prove that these three cultures were well joined. It is also hard to speculate the cause of this discontinuity. It was probably caused by some disastrous events or simply due to the sporadic archaeological excavations carried out.

The second big discontinuity (Fig. 136) emerges during the middle Western Zhou period to the early Spring and Autumn period (about 900-700 BCE). It may be a result of the haphazard excavation undertaken. Moreover, the scarcity of cultural remains may be due to infrequent human activities at that time.

Immediately after, the so-called Ordos bronze cultures came on stage in north-central China. The flourishing Yanglang, Taohongbala, and Maoqinggou cultures were distributed side by side from the early Spring and Autumn period to the late Warring States period. On one hand, they show some common characteristics, such as animal sacrifices, splendid metal objects in a strong pastoral style, and so on. On the other hand, they distinguish themselves by their burial patterns, bronze assemblages, and subsistence⁶⁴³.

Besides, the cultural ascription of some sites found with northern-style bronzes in

⁶⁴² Tian G. J. 1997b, 266-307.

⁶⁴³ The slight difference in subsistence will be discussed in the following Chapter 6.2.3.

north-central China is still controversial. For example, the Xiyuan cemetery⁶⁴⁴ is characterized by earthen shaft pits with a side pit and a second platform, animal victims, and small bronze ornaments (Fig. 095). Therefore, it is hard to ascribe it to any so-called Ordos bronze culture.

⁶⁴⁴ See Chapter 2.4.12.

Chapter 5 The South of the Yanshan Complex

The South of the Yanshan Complex designates the bronze-using cultures distributed within the northern Hebei region and the Beijing and Tianjin regions, as almost corresponding to the south of the Northeast Complex which is defined by Pak. Its individuality has been recognized gradually by scholars. On the cultural ascription of some sites, scholars have not agreed. Despite all of this, the cultural aspects of the Datuotou culture, Weifang III culture, Upper Zhangjiayuan culture, and Yuhuangmiao culture become more and more clear.

5.1 Datuotou culture

5.1.1 Definition and distribution

The Datuotou culture is named after the Datuotou site in Chang county, Hebei Province, yielding 2 houses together with some potteries, stone wares, animal bones, and bronze arrowheads⁶⁴⁵. It took a long time for the recognition of the Datuotou culture to be accepted by archaeologists. Previous research generally attributes such remains that are similar to those found from the Datuotou site to the Lower Xiajiadian culture, ‘the Yannan type of the Lower Xiajiadian culture’⁶⁴⁶, ‘the Yanshan type of the Lower Xiajiadian culture’⁶⁴⁷, or the ‘North-Haihe complex of the Lower Xiajiadian culture’⁶⁴⁸. Some scholars divide such remains found from the south of the Yanshan into ‘the Datuotou type’ and ‘the Huliuhe type’. With increasing archaeological fieldwork and related materials, some scholars put forward that the cultural remains distributed in the south of the Yanshan during the Xia and Shang period should be excluded from the Lower Xiajiadian culture, implying an early independent bronze culture in terms of the potteries, burials, and settlements⁶⁴⁹. So far, many sites found together with bronze objects have been identified as the Datuotou culture (Table 43), as well as some sites without bronze objects, including Pangjiahe⁶⁵⁰, Jancun I, II⁶⁵¹, Banjiegou⁶⁵², Qianbao, Zhuangke, Sishilipo⁶⁵³ and Jiaozhuang⁶⁵⁴ in Hebei Province, Liujiage⁶⁵⁵ and Fenghuangshan⁶⁵⁶ in Beijing, Niudaokou II⁶⁵⁷ and Qingchi⁶⁵⁸ in

⁶⁴⁵ Han J.G. 1966, 8-13.

⁶⁴⁶ Li J. H. 1980, 163-170.

⁶⁴⁷ Zou H. 2001d, 233-270.

⁶⁴⁸ Zhang Z. P. et al. 1987, 58-78.

⁶⁴⁹ Beifangcaoyuan 2007, 40.

⁶⁵⁰ JMHK 1988, 421-453.

⁶⁵¹ HBW 1992.

⁶⁵² Liu/Li 2002.

⁶⁵³ ZJKK 1984.

⁶⁵⁴ ZJKK 1984.

⁶⁵⁵ BJWG 1992, 51-64.

⁶⁵⁶ BJKG40.

Tianjin (Map 20).

Site	Contexts	Bronze objects	Reference
Xiaoguanzhuang, Tangshan, Hebei	6 cist graves	Earrings	An Z. M. 1954, 81-82
Dachengshan, Tangshan, Hebei	Pits; burials		HBWG 1959, 17-35
Guye, Tangshan, Hebei	2 pits	Needle; knife; loop	HBW 1984, 769-778
Dongzhuangdian, Luannan, Hebei	1 pit	Fragment	HBW 1983, 775-778
Sanguan, Yu, Hebei	Settlement; burials	Earring	ZJKK 1984
Lidarenzhuang, Zhangjiakou, Hebei	6 pits; 9 burials	Loop	ZJKW et al. 1990, 398-402.
Xiayuegezhuang I, Yi, Hebei	15 pits	Arrowhead; earring; hair clasp;	JMHK 1988, 421-453
Qinggongtai, Langfang, Hebei		Gold armlet	LFW et al. 1999, 26-30
Xueshan III, Beijing	Pits; burials	Arrowheads; earrings; knives	Lu/Ge 1978, 23-34; Zou H. 2001d, 242-244
Liulidian, Beijing	2 graves	Earrings; rings	TJW 1979, 163-171
Tazhao, Beijing	Pits, burials	Earring	BJWY 1989, 205-218; BJWY 1999, 1-27.
Zhangjiayuan, Ji county, Tianjin	Pits; settlements	Arrowheads; knives, earrings	TJW 1979, 163-171; TJLBW 1984, 698-705; 1993, 311-323
Weifang II, Tianjin	1 house; 3 pits	Knives; earring	TJWK 1983, 877-893

Table 43. Bronzes of the Datuotou culture.

Conclusively, the Datuotou culture is roughly distributed in the south of the Yanshan, reaching the Zhangjiakou region and Huliuhe Valley to the west, the Yanshan to the north, Bohai to the east, and the Laishui and Jumahe in the south (Map 20). Of course, some scholars have arguments over its range because some remains of the Datuotou culture were even found north of the Yanshan⁶⁵⁹ and south of the Jumahe valley⁶⁶⁰.

The differences between the Datuotou culture and the Lower Xiajiadian culture are

⁶⁵⁷ TJLBK et al. 1991, 577-586.

⁶⁵⁸ TJLBK 2001, 96-97.

⁶⁵⁹ Tian S. H. 1995, 48-52.

⁶⁶⁰ HBW et al. 1992.

reflected in many aspects. Firstly, the representative potteries of the Lower Xiajiadian culture such as cylinder-shaped cooking ware-Li and Yan were rarely seen in the Datuotou culture. By contrast, the round-belly Li which was very common in the Datuotou culture was however scarce in the Xiajiadian culture. Secondly, remains of stone city and altar pits found in the Lower Xiajiadian culture have not been discovered in the Datuotou culture. Furthermore, neither the adobe technique used in architecture nor the niche used in the burials are seen in the Datuotou culture. In addition, the quantity of bronze objects from the Datuotou culture exceeds those of the Lower Xiajiadian culture.

5.1.2 Chronology, periodization, and origin

The Weifang, Guye, and Niudaokou sites provide stratigraphical evidence (Table 44), showing that the Datuotou culture should be later than the Longshan culture, and earlier than the Weifang III culture⁶⁶¹. Since the Weifang III culture is contemporary with the end of the Shang period and the beginning of the Zhou period, the Datuotou culture should not be later than the first phase of the Yinxu. Besides, several radiocarbon dates from the Sanguan and Qianbao sites (Appendix) fall mainly between 1900-1300 BCE, corresponding to the relative chronology based on the stratigraphical evidence.

Weifang (T8)		Niudaokou		Guye	
Layer	Culture	Layer	Culture	Layer	Culture
II	Weifang III			III	Weifang III
III	Datuotou	V	Datuotou	IV	Datuotou
IV, V	Neolithic	VI	Longshan		

Table 44. Stratigraphical evidence of the Datuotou culture.

Scholars differ slightly in their opinions on the periodization of the Datuotou culture in view of the stratigraphical evidence and pottery assemblages. As suggested by Wu En, who divides the Datuotou culture into two types; Datuotou and Huliuhe. Both types are synchronous in development though the former is bordered on the north by the Lower Xiajiadian culture, while the latter is bordered on the east by the bronze cultures, west of the Taihang Mountain. Therefore, Wu En proposes a three-phase periodization of the Datuotou culture. The early phase is characterized by the earth pit graves that were sometimes built with a second platform, and tripod cooking wares, such as a cylinder-shaped Li, and oblique-belly Li without feet, and so on. The middle phase is represented by the cylinder-shaped Li with shorter feet and crotch, and round-belly Li in the typical Shang style. During the late phase, some cist graves emerged north of the Datuotou type, meanwhile, some urn burials appeared in the

⁶⁶¹ The Weifang III culture will be discussed in the next section.

Huliuhe. The cylindrical-shaped Li with shorter feet and body, and a round-belly and oblique belly in a strong Shang-style, as well as the angular-shouldered Li came into vogue (Table 45; Fig. 111a).

Phase	Representative remains	Features	Date (BCE)
Early	Weifang III, Zhangjiayuan 9T1③; Sanguan 82m2008, 82M2010	Earth pit graves; the dead lying in an extended supine position; cylinder-shaped Li, oblique-belly Li without feet, round belly Li.	1900-1700
Middle	Zhangjiayuan 79T②, 65F4; Sanguan 82M2047, 82H2022, Qianbao 82F1	Earth pit graves; cylinder-shaped Li with shorter feet; round-belly Li in the Shang style appeared.	1700-1500
Late	Zhangjiayuan 65T1④; Lijiadian M1; cist graves of Xiaoguanzhuang; Qianbao 82 TB1②; Sishilipo 81H28	Some cist graves and urn burials; cylinder-shaped with shorter feet and body; more Shang-style Li; angular-shouldered Li appeared.	1500-1400

Table 45. Periodization of the Datuotou culture⁶⁶².

As we know, the cylinder-shaped Li (Fig. 111a, 1-6) reflects the close relations between the Lower Xiajiadian culture and the Datuotou culture, implying that the former may have spread southwards. However, the typical tripod cooking wares such as the round-belly Li and Yan of the Datuotou culture are seen neither in the Lower Xiajiadian culture nor in its precursor. Thus, the traditional opinion, which regards the Lower Xiajiadian culture as the origin of the Datuotou culture is heavily questioned, though their close relations cannot be neglected.

Wu En proposes that the Datuotou culture originated from the Longshan culture in Hebei, that is represented by Xueshan II. However, Xueshan III is attributed to the Datuotou culture. The Xueshan site provides stratigraphical evidence, showing that Xueshan I, II, and III were continuous in their cultural development; for example, tripod-cooking wares-Yan and round-belly-Li were very common in Xueshan II (Fig. 111b). Accordingly, this study prefers to believe that the Datuotou culture originated from Xueshan II. As for the offspring of the Datuotou culture, it is accepted by some scholars that the Weifang III culture originated from the Datuotou culture, which will

⁶⁶² Beifangcaoyuan 2007, 46-47.

be elaborated upon in the next section.

5.2.3 Metal objects

Dozens of metal objects have been found in the Datuotou culture, including 5 knives, 4 arrowheads, 8 earrings, 3 rings, 2 plaques, some needles, and 1 gold armlet⁶⁶³ (Fig. 111c). Most of them are small ornaments in simple forms. In addition, the bronze earrings with one pointed end and another flaring end are quite remarkable. The armlet found from the tomb at the Qinggongtai site was made from gold.

If we look back on the copper and bronze objects found from the Qijia culture (Fig. 099b) and the Siba culture (Fig. 104b), undoubtedly, the bronze objects of the Datuotou culture (Fig. 111c) show great similarities to them. In view of the amount, types, and date of the bronze objects in northwest China, we can infer that the bronze metallurgy of the Datuotou culture may have been heavily influenced or even imported from northwest China. Afterwards, the metal technique was probably introduced from the Datuotou culture into the Lower Xiajiadian culture via the Yanshan since less bronze earrings were unearthed from the Lower Xiajiadian culture until now⁶⁶⁴.

The use of bronze objects was a great leap in the Datuotou culture. It is worth mentioning that one stone mold for an axe with copper ashes was collected from the Guye site. Slag was discovered in some of the sites, indicating that the local people had grasped some technological skills though only small-scale bronze objects have been found so far. No further information on a metallurgical analysis is accessible.

5.2 Weifang III culture

5.2.1 Definition and distribution

The Weifang III culture is named after the third phase of the Weifang site which yielded remains of one stove and two bodies together with potteries, stonewares, animal bones, bronze chisels and so on⁶⁶⁵. It is distributed mainly in the south of the Yanshan, bordered by the Taihang Mountain on the west, the Luanhe Valley on the east, and the Jumahe region on the south (Map 21). Many sites have been identified as the Weifang III culture, including Dongmenggezhuang⁶⁶⁶, Xiematai⁶⁶⁷, Beifudi⁶⁶⁸, Tazhao II⁶⁶⁹ and Zhenjiangying⁶⁷⁰. Of them, some sites have been found together with

⁶⁶³ Beifangcaoyuan 2007, 52-53.

⁶⁶⁴ Beifangcaoyuan 2007, 55.

⁶⁶⁵ TJWK 1983, 877-893.

⁶⁶⁶ Ma H. L. 1983, 478,

⁶⁶⁷ TJLK 1996, 14.

⁶⁶⁸ JMhk 1988, 421-453.

⁶⁶⁹ BJWY 1989, 205-218; BJWY 1999, 1-27.

⁶⁷⁰ BJWY 1989, 210.

bronze objects (Table 42).

Site	Contexts	Bronze objects	Reference
Bangjun, Ji, Tianjin	6 tombs	Ritual objects	TJLBK et al. 1988, 98
Mashao, Qian'an, Hebei	collected	Ritual objects	Li/Yin 88-89
Donghangezhuang, Lulong, Hebei	1 tomb	Ding; Gui; bow-shaped object; gold armlets	Tang Y. M. 1982, 44-46
Chenshantou, Luan, Hebei	1 tomb	Ding; Gui; axes; bow-shaped objects	Meng/Zhao 1994, 376
Xiaoshandongzhuang, Qian'an, Hebei	tombs	Ritual objects; gold armlets, earrings	Li/Yin 1995, 58-62
Liujiache, Beijing	Tomb M1	Ritual objects; horse and chariot fittings; gold armlet, earring, hair clasp	BJWG 1977, 108
Zhangjiayuan, Ji, Tianjin	4 tombs	7 ritual objects; 4 gold earrings	TJLBK 1993, 311-323
Chaodaogou, Qinglong, Hebei	hoard	Sword; socket axe, Ge; deer-pommel, loop headed and bell-headed knife	HBWW 1962, 644-645
Guye III, Tangshan, Hebei	8 pits	Knives	HBW 1984, 769-778
Jiuncun III, Laishui, Hebei	38 pits	Earrings; knives	HBW 1992

Table 46. Bronze objects from the Weifang III culture.

Since the designation of the Weifang III culture was put forward in the 1980s, the research work has much improved with the increase of archaeological fieldwork (Table 47). However, some scholars still insist that the remains of the Weifang III site cannot represent an independent culture (Table 48). From Table 47 and Table 48, we can see that there is still great disagreement amongst scholars on this issue.

Author, reference	Opinions
Han J. G. 1984, 220-229.	There were two cultural systems in the Tianjin and Beijing regions during the Shang and Zhou period: local cultures and the Shangzhou culture. The former includes the Datuotou culture, Upper Weifang culture, and Upper Zhangjiayuan culture.

	1993, 355-364.	Summarizes three excavations of the Zhangjiayuan site and corrects some mistakes in previous archaeological reports. He emphasizes that the Weifang III culture is a transitional culture between the Datuotou culture and the Upper Zhangjiayuan culture, dating to between the Upper Erligang culture period and the end of the Shang period.
Shen Y. 1993, 21-26		He divides the Weifang III culture into four phases: phase I is parallel to the Yinxu II period; phase IV is parallel to the early Western Zhou period.
Yang J. H.	1999, 1-19	The cultures in the south of the Yanshan can be divided into two continuous types: Datuotou and Weifang III. The latter was distributed wider than the former.
	2002, 157-175	She classified the bronzes found from south and north of the Yanshan into several groups: A group, represented by bronzes from the Liujiahe burials implies the Shang nobility moved northwards and influenced the local people; C group, including the bronzes found from Zhangjiayuan, Chenshantou, Donghangezhuang, Xiaoshandongzhuang, Mashao, and Bangjun, should be ascribed to the Weifang III culture.
Liu Xu/Zhao Fusheng 2001, 146-152		Remains of the Zhangjiayuan site belonged to the Yan culture; however remains of the Weifang III and the Weiyingsi site, which lies north of the Yanshan should be regarded together as the Weifang III culture.

Table 47. Opinions regarding the Weifang III culture as an independent culture.

Author, reference	Opinions
Li B. Q. 1994, 131-143	He attributes the so-called Weifang III culture and remains of the Upper Zhangjiayuan site to one and the same culture. In addition, he divides them into 3 periods and 5 phases from the Yinxu II period to the early Western Zhou period.
Liang/Yu 2001, 17-23	Remains of the Weifang III site and the Zhangjiayuan site represent two parallel types of one and the same culture.
Ji L. M. 2002.	The cultures distributed in the south of the Yanshan can be divided into Datuotou, Lower Xiajiadian, Upper Zhangjiayuan, Jiyan, Upper Xiajiadian, Jundushan, and curved-bladed bronze sword cultures.

Table 48. Opinions against the Weifang III culture as an independent culture.

In short, the subject of this argument is whether or not the local cultural remains distributed in south of the Yanshan during the late Shang period to the early Western Zhou period can represent one independent culture, namely the Upper Zhangjiayuan culture, or should it be classified as two continuous cultures: the Weifang III culture and the Upper Zhangjiayuan culture. The stratigraphical evidence from the Weifang and Xiematai sites provides the chronological sequence. The typical Upper

Zhangjiayuan potteries, such as the high-necked tripods-Li with overtopped lips, joint-croched tripods-Li in the Zhou style, socket-leg tripod-Li in the Shang style and thick-lipped vessels-Gui are scarce in the Weifang III site. Accordingly, this study prefers to believe that the Weifang III culture and the Upper Zhangjiayuan culture⁶⁷¹ represent two continuous cultures in the south of the Yanshan Complex.

5.2.2 Chronology, cultural elements, and origin

The chronology of the Weifang III culture suggested by the excavators, from the Shang and Zhou period to the beginning of the Eastern Zhou period has been seriously questioned. Until now, the opinions on the chronology and periodization of the Weifang III culture still differ⁶⁷². With respect to the periodization, Yang Jianhua and Wu En propose a two-phase chronology (Table 49), which fall in the three radiocarbon dates resulted from the Liujiafen site: 2770±75 B. P., 2980±75 B. P., 2920±80 B. P. (Appendix).

	Sites	Characters	Date (BCE)
Early	The second layer of the Weifang site; Fuwei III; Zunhua; Lidarenzhuang H2; Donghangezhuang; Shangheyingsi;	Vertical slim cord mark decorated on pottery; tripod cooking wares such as Yan and lace-ringed Li	Yinxu I, 1300-1200
Late	The first layer of the Weifang site; Zhangjiayua; Bangjun; Jiansun H7	Crossed thick cord mark decorated on pottery; potteries with more Central Plain style	Yinxu II, 1200-1100

Table 49. Periodization of the Weifang III culture proposed by Wu En and Yang Jianhua.

The cultural elements contained in the Weifang III culture are quite complicated. The hoard and burials found together with bronze objects can be divided into three groups: A, ritual bronzes in the Shang style; B, Northern-style bronzes; C, mixture of ritual bronzes and Northern-style bronzes. The Lijiaya culture, distributed in the north of Shaanxi and northwest of Shanxi (see Chapter 4.2) has also such three kinds of bronzes. Regarding the ritual bronzes, they may have been owned by the central China people who moved into the northern region or the local people who gained them by trade or other ways. Moreover, the gold earrings with one flaring end and armlets with fan-shaped ends, which were buried in the Liujiahe site do not seem to belong to the Shang people though some bronze ritual objects were discovered as well. As proposed

⁶⁷¹ It will be discussed in the next section.

⁶⁷² Shen Y. 1993, 21-26; Han/Ji 1993, 355-364; Liu/Zhao 2001, 146-152.

by Wu En, the Weifang III culture, centered itself on Tianjin, Beijing and Tangshan, represents a local bronze culture, though it was influenced strongly by the Shang culture. The ritual objects probably implied the social status and richness of the local people who liked to imitate the funeral practices from the Shang people⁶⁷³.

As mentioned in chapter 4.4.2, it is mostly accepted by scholars that the Weifang III culture originated from the Datuotou culture, which can be proven from two aspects. On one hand, the Weifang, Xiematai, Jiacun sites show that the remains of the Weifang III culture overlies on remains of the Datuotou culture, implying their continuous relations. On the other hand, many features of the Datuotou culture can also be seen in the Weifang III culture, such as round-belly Li, angular-shouldered pots, gold earrings with one flaring end, bronze knives, arrowheads and so on (Fig. 111a; Fig. 112a; Fig. 111c; Fig. 112b).

5.2.3 Metal objects

As mentioned above, the metal objects of the Weifang III culture consist of three styles: Northern-style, Shang style, and mixture of two styles. Of the bronze ritual objects, tripods Ding and Gui (Fig. 112b, 17.-19.22) are the most common. Besides, some inscriptions on the bronzes are still identifiable, such as ‘戈父丁’, ‘天’, ‘口乍? 鼎’ and so on.

In brief, the main characteristic of the Weifang III culture is the northern-style bronzes (Fig. 112b, 1-16). It is worth mentioning that the pick-dagger (Fig. 112b, 6) may well be the precursor of the crane hooks, which were very popular in northern China in the later period. Furthermore, the loop-headed knives (Fig. 111b, 3) and gold earrings with a round and pointed end are also seen in the Siba culture which was distributed in the northwest of China. The deer-headed swords and knives, bell-headed knives, socketed axes and bow-shaped objects⁶⁷⁴ were very common in northern China. Apart from the bronze objects, gold earrings and armlets also have a sharp local style, indicating the developed metallurgical techniques used at that time. The metallurgical analysis has not been carried out.

5.3 Upper Zhangjiayuan culture

5.3.1 Definition and distribution

The Upper Zhangjiayuan culture was named after the fourth type of remains from the Zhangjiayuan site that was discovered in the third season of an excavation in 1987. Remains revealed in the second season of 1979 are regarded as the Weifang III culture.

⁶⁷³ Beifangcaoyuan 2007, 121-122.

⁶⁷⁴ The function of the bow-shaped objects aroused arguments amongst scholars. It will be discussed in the following sections.

Except for the Zhangjiayuan site, the third layer of Niudaokou⁶⁷⁵, later remains of Guye⁶⁷⁶, Tanshan⁶⁷⁷, Xiematai⁶⁷⁸ are identified as the Upper Zhangjiayuan culture as well. Besides, some sites were found together with bronze objects, including Baoshenmiao, Dongnangou, Liushugou, Xiaohenan, Niuquanziliang, Donggoudaoxia, Baifu, Xibozi, Zhengjiangying and Bangjun (Table 50; Map 22). Of them, the cultural ascription of some sites aroused great arguments. Compared to the Weifang III culture, the Zhangjiayuan culture was distributed in a smaller region.

Sites	Contexts	Bronze objects	Reference
Baoshenmiao, Tangshan, Hebei	collected	5 stone molds for spear, axe and knife	An Z. M. 1954, 81-82.
Liushugou, Pingquan, Hebei	5 tombs	knife; spear; axe; beads	Zheng S. Z. 1977, 51-55.
Niuquanziliang, Manzu, Hebei	1 cist grave	earring	HBW 1998, 127-132.
Donggoudaoxia, Tucheng, Hebei	1 cist grave	knife; awl; chisel; mirror; bulb and stone mold	Bai G. 1999, 23-27.
Zhengjiangying, Beijing	Shangzhou III layer	Earring	ZT 99
Bangjun, Ji, Tianjin	Settlements	Arrowhead	TJLBK et al. 1988, 98.
Dongnangou, Pingquan, Hebei	26 tombs (16 cist graves)	sword; dagger; knife; plaque; bulb; earring	Zheng S. Z. 1977, 51-55, Fig. 116.
Baifu, Changping, Beijing	3 tombs	over 100 bronze objects; some jades	BJWG 1976, 246-258; Fig. 113a-113c.
Xibozi, Yanqing, Beijing	hoard	Fu-cooking ware; Ding; spoon; dagger; knife; awl; axe; adze; bulb	BJWG 1979, 227-230; Fig. 115.
Xiaohenan, Xinglong, Hebei	hoard	10 bronzes: sword, dagger, spear, axe, knife, cover	Wang F. 1990, 57-58; Fig. 114.

Table 50. Bronzes from the Upper Zhangjiayuan culture.⁶⁷⁹

⁶⁷⁵ TJLBK et al. 1991, 577-586.

⁶⁷⁶ HBW 1984, 769-778.

⁶⁷⁷ JMHK 1988, 421-453.

⁶⁷⁸ TJLBK 1991, 14-24.

⁶⁷⁹ The cultural attribution of the Baifu, Xibozi, Xiaohenan and Dongnangou sites are still under dispute. See chapter 5.3.2.

As mentioned before, it is still a matter of dispute whether the Upper Zhangjiayuan represents an independent culture. Han Jiagu holds the view that the Datuotou culture, the Weifang III culture and the Upper Zhangjiayuan culture are the continuous bronze cultures in the south of the Yanshan Complex⁶⁸⁰. Some other scholars⁶⁸¹ believe that the Datuotou culture (or the so-called Lower Xiajiadian culture) was succeeded by the Zhangjiayuan culture or Upper Zhangjiayuan culture, including both remains from the upper Weifang site and upper Zhangjiayuan site. In fact, these two arguments differ only on whether the Weifang III culture or the Upper Zhangjiayuan culture represents one independent culture respectively.

This study prefers to regard them as two separate cultures. Firstly, some typical potteries of the Zhangjiayuan culture are absent in the Weifang III culture. Secondly, some sites, such as Beifeng, Duntai and Tanshan were discovered with little remains similar to the Weifang III culture. Thirdly, the Xiematai site provides stratigraphical evidence for the relative date of the high-necked tripod-Li with a layered lip and the straight-necked tripod-Li with raised patterns. Finally, the Yan State⁶⁸², which was subinfeuded by the Zhou Dynasty around the Tianjin and Beijing regions, may have caused the cultural changes.

5.3.2 Chronology, origin, and cultural attribution of some sites

As far as the cultural attribution of the Baifu cemetery, Dongnangou cemetery, Xibozi hoard, and Xiaohenan hoard (Table 50) is concerned, the scholars have different opinions. Some scholars propose⁶⁸³ that the Baifu cemetery (Fig. 113a-c) and Xiaohenan hoards (Fig. 114) as well as the Liulihe cemetery⁶⁸⁴ were owned by the Shang people of the Yan State who were influenced by the northern people. In addition, the Xibozi hoard (Fig. 115) and Dongnangou cemetery (Fig. 116) reflect the impact of the Upper Xiajiadian culture, which was distributed in the north of the Yanshan. While Wu En ascribes all of them to the Upper Zhangjiayuan culture on the assumption that the local nobility imitated the funeral practices from the Central Plain or north of the Yanshan.

As we know, the Baifu and Xiaohenan cemeteries are characterized by the tombs built with a coffin and outer-coffin, buried together with some bronze ritual vessels, horse fittings, and some northern-style weapons and tools (Fig. 113a-111c; Fig. 114). The Xibozi hoard yielded many typical northern-style bronzes (Fig. 115), such as tripod-Li and cooking-ware Fu with double ears (Fig. 115, 22-23) which are very distinctive. The Dongnangou cemetery is recognized by cist graves and northern-style bronzes

⁶⁸⁰ Han J. G. 1981, 220-229; Han/Gi 1993, 355-364.

⁶⁸¹ Shen Y. 1993, 21-26; Li B. Q. 1994, 131-143; Zhang et al. 1987, 58-78.

⁶⁸² It means 姬姓燕国 (Ji xing Yan guo—the Yan State with the last name of Ji) .

⁶⁸³ Jin/Wang 2001, 43-92; Yang J. H. 2000, 22-30; Yang J. H. 2002, 157-175.

⁶⁸⁴ Liulihe 1995.

(Fig. 116). The cist grave was also very common in the Upper Xiajiadian culture. However, the assemblage of bronzes differs between the Dongnangou cemetery and the Upper Xiajiadian culture.

In the process of dissemination, cultures affect and communicate with each other, which probably resulted in the similarities of pottery or bronze objects between cultures. However, the burial pattern of each culture is hard to change even with frequent connections or impacts from the outside. Accordingly, this study agrees to propose that the Baifu and Xiaohenan sites reflect the Shang people of the Yan State were influenced by the northern people and northern cultures, and the Dongnangou cemetery and the Xibozi hoard provide evidence that the Upper Xiajiadian culture may have gone over to the south of the Yanshan⁶⁸⁵. That is, these four sites were unfit for any culture in the south of the Yanshan Complex.

These four sites are dated from the middle Western Zhou period to the early Spring and Autumn period. Therefore, Wu En proposes that the Upper Zhangjiayuan culture should end by the late Western Zhou period and the beginning of the Spring and Autumn period. As mentioned above, this study excludes these sites from the Upper Zhangjiayuan culture. Accordingly, the chronology of the Upper Zhangjiayuan culture is limited to the early and middle Western Zhou period, roughly between 1100-900 BCE.

Conclusively, the characteristics of the Upper Zhangjiayuan culture are not very distinctive until now. It is hoped that future archaeological fieldwork will provide fresh materials for the Upper Zhangjiayuan culture and new clues for the cultural ascription of the Baifu, Dongnangou, Xibozi, and Xiaohenan sites.

5.3.3 Metal Objects

Some stone molds for adz, socket spear, and knife were found in the Upper Zhangjiayuan culture (Fig. 117b, 7-12), including single mold and joint molds. So far, only a small quantity of the bronze objects have been identified as belonging to the Upper Zhangjiayuan culture, consisting of adzes, knives, bulbs, mirrors, awls and chisels (Fig. 117b, 1-6). The mirror-shaped objects with a bridge button on the back (Fig. 117b, 4) may have been used to decorate the clothes, which was very common in the Eurasian Steppe. The knives with nipple protrusions are quite remarkable (Fig. 117b, 5.10). According to the stone molds shown in Fig. 117b, 11 and Fig. 117b, 12, we can infer that the socket spear is about 13-15cm in length with protrusions and hooks on the handle. This kind of spear was also seen in the Kayue culture (Fig. 101d, 24), which is 61.5cm long.

⁶⁸⁵ The cultural relations will be discussed more in chapter 6.

With the expansion of the Yan State in the Western Zhou, it is understandable that the Upper Zhangjiayuan culture was distributed in a smaller region in contrast to the Weifang III culture. In addition, the south of the Yanshan region became a cultural melting pot, so it is quite common that one site is unearthed with mixed cultural remains. Therefore, it is hard to identify sites with only the remains of the Upper Zhangjiayuan culture. Compared to the earlier bronze cultures in the south of the Yanshan Complex, the smaller quantity of bronze objects from the Upper Zhangjiayuan culture does not imply that the metallurgical technique went backward. The metal objects found at the Baifu, Xibozi, Dongnangou and Xiaohegou sites prove the complicated cultural interactions in the Yanshan region during the Shang and Zhou period.

5.4 Yuhuangmiao culture

5.4.1 Definition and distribution

The Yuhuangmiao culture was formally put forward by Jin Fengyi, on the basis of the research of the bronze dagger-shaped swords with straight blade found in the northern Hebei region⁶⁸⁶. In previous research, the excavators of the Yuhuangmiao cemetery address it as the Shanrong⁶⁸⁷ culture because they believe that the owners of the cemetery were the ancient Shanrong people⁶⁸⁸. Later, some scholars questioned its ethnic ascription and put forward the ‘Beixinbao culture’ after the excavation at the Beixinbao site⁶⁸⁹. Immediately after, Yang Jianhua divided the cultural remains of the northern Hebei region during the Zhou period into five groups: 1) the Baifu cemetery in Changping; 2) the Xibozi hoard in Yanqing; 3) the Dongnangou cemetery in Pingquan; 4) the Eastern Zhou cemeteries in Jundunshan; 5) the fourth and fifth remains of the Baimiao site in Zhangjiakou⁶⁹⁰. Of them, the fourth group is quite complicated, and is roughly identical to the so-called ‘Yuhuangmiao culture’.

The Beijing Institute of Cultural Relics excavated the Yuhuangmiao, Hulugou, and Xiliangguang cemeteries in the Yanqing county between 1985 and 1990. Altogether, about 570 burials were excavated at the three cemeteries, along with different kinds of grave goods, numbering about 20,000 items in all. The Yuhuangmiao cemetery is the largest of the three, with 400 excavated graves and lots of information⁶⁹¹. It is worth mentioning that some scholars have made an in-depth study on the Yuhuangmiao cemetery, with particular attention being paid to explain the social division and

⁶⁸⁶ Jin F. Y. 2001, 194-214.

⁶⁸⁷ One ancient tribe described in Chinese document.

⁶⁸⁸ BWSR 1989, 17-35.

⁶⁸⁹ Lin Y. 1998h, 174-183.

⁶⁹⁰ Yang J. H. 2000, 22-30.

⁶⁹¹ BWSR 1989, 17-35.

differentiation, subsistence economies, ethnic ascription, and cultural relations with one another, in view of the environment and layout of the cemetery, mortuary practice, burial goods, and object assemblages⁶⁹². In addition, the mortuary practice such as face-masking, earrings, necklaces, and animal-style plaques are the most remarkable characteristics of the Yuhuangmiao cemetery. The individuality of the Yuhuangmiao cemetery is distinctive, so this study prefers to use the designation of the ‘Yuhuangmiao culture’ for the remains found, which are similar to the Yuhuangmiao cemetery.

With increasing archaeological fieldwork being carried out since the 1980s, the research of the Yuhuangmiao culture has been much improved, though some scholars still hold different opinions on some points. On the distribution of the Yuhuangmiao culture, the scholars are in agreement with the opinion that it reached Zhangjiakou in the west, and Luanping and Longhua in the east. The center of the Yuhuangmiao culture is in the northern hilly areas of Hebei that is located north of the Taihang Mountain, including the Jundushan and Yanshan mountains. Except for the Beixinbao, Qingzigou, Luotuoliang, Paotaishan, Baimiao, Ganzibao, Nihezi, Xiaobaiyang, Yuhuangmiao, Hulugou, Xilianguang, Lishugoumen, Longqingxia, and Daolazui sites (Table 51; Map 23), Wu En confirms the Hanjiafen⁶⁹³ and Huangtupo⁶⁹⁴ sites as belonging to the Yuhuangmiao culture too.

Sites	Contexts	Bronze objects	Reference
Beixinbao, Huailai, Hebei ⁶⁹⁵	2 tombs with animal victims	Ritual objects; weapons, horse and chariot fittings, ornaments; gold earrings and buttons	Fig. 118
Qingzigou, Luanping, Hebei ⁶⁹⁶	2 tombs	Swords, arrowheads, knives, axes, bulbs, plaques etc.	Fig. 119
Luotuoliang, Longhua, Hebei ⁶⁹⁷	1 tomb	Sword, knife, bead, arrowhead, bulbs	Fig. 120
Paotaishan, Heshenha,	4 tombs		Fig. 121

⁶⁹² Pak Y. J. 1996, 415-465; Jin F. Y. 1990, 61-73; 2001, 194-213.

⁶⁹³ Arne 1933, Tarif I-VIII; XIV, 2. This site produced over 100 bronze objects and some gold objects, including swords, axes, knives, arrowheads, belt hooks, awls, chisels, animal-style plaques, buttons, and ornaments.

⁶⁹⁴ Arne 1933, Tarif IX-XIII; XIV, 1.3.4. This site yielded about 90 bronze objects, including swords, knives, axes, arrowheads, loops, animal-style plaques, and ornaments.

⁶⁹⁵ HBWW 1966, 231-242.

⁶⁹⁶ Zheng S. Z. 1984, 45-46.

⁶⁹⁷ Zheng S. Z. 1984, 46.

Luanping, Hebei ⁶⁹⁸			
Ganzibao, Huailai, Hebei ⁶⁹⁹	21 tombs	Over 1100 bronze objects, including ritual objects, weapons, horse and chariot fittings, ornaments	Fig. 122a- c.
<i>Baimiao, Pangjiabao, Zhangjiakou, Hebei⁷⁰⁰</i>	<i>1 pit and 4 tombs</i>	<i>Sword (collected)</i>	<i>Fig. 123</i>
Nihezi, Zhangjiakou, Hebei ⁷⁰¹	collected	Sword, axe, horse bit, plaque.	Fig. 124
<i>Xiaobaiyang, Zhangjiakou, Hebei⁷⁰²</i>	<i>48 tombs</i>	<i>Swords, axes, knives, awls, arrowheads, chisels, ornaments</i>	<i>Fig. 125</i>
Liushugoumen, Luanping, Hebei ⁷⁰³	tombs	Weapons, ornaments	Fig. 126a- c
Daolazui, Zhulu, Hebei ⁷⁰⁴	1 tomb	vessels; figures; Ge; knife; gold necklace	Fig. 127
Longqingxia, Beijing ⁷⁰⁵	12 tombs	Ritual objects, horse fittings, ornaments, dagger, arrowheads, daggers.	Fig. 128
Yuhuangmiao, Yanqing, Beijing ⁷⁰⁶	Over 400 tombs	Ritual objects, weapons, ornaments, gold objects	Fig. 129a- b

Table 51. Discoveries of bronze objects from the Yuhuangmiao culture suggested by Wu En.

The scholars hold different opinions regarding the cultural ascription of some sites such as Baifu (Fig. 113a-c), Xibozi (Fig. 115), Dongnangou (Fig. 116), and Baimiao (Fig. 123). As discussed in Chapter 4.6, Wu En ascribes the Baifu, Xibozi, and Dongnangou sites to the Upper Zhangjiayuan culture, and the Baimiao site to the

⁶⁹⁸ Zheng S. Z. 1983, 67-74.

⁶⁹⁹ He/Liu 1993, 23-75; HBWX 1980, 30.

⁷⁰⁰ ZJKW 1985, 23-30.

⁷⁰¹ Zhang/Tao 1983, 94.

⁷⁰² Tao Z. Y. 1987, 41-49.

⁷⁰³ CDW et al. 1994, 15-30; LPB 1995, 8-15.

⁷⁰⁴ Chen X. 1999, 31-32.

⁷⁰⁵ BJWY 1994, 32-45.

⁷⁰⁶ BWSR 1989, 17-35.

Yuhuangmiao culture. While Jin Fengyi attributes the Xibozi and Dongnangou sites to the Yuhuangmiao culture. On this issue, this study agrees with Yang Jinhua and would not ascribe these sites to any other culture for the time being, but regards them as separate groups found in the northern Hebei region during the Zhou period.

5.4.2 Chronology and some problems

As we can see in Table 51, burials are the representative remains of the Yuhuangmiao culture. The burial goods, especially the bronze ritual objects similar to those found from the Yan State and Central Plain provide vital information for the relative chronology. Wu En proposes a two-phase periodization for the Yuhuangmiao culture. The early phase is marked by the Yuhuangmiao, Xilianguang, Hulugou, Xiaobaiyang and Ganzibao sites; the late phase is represented by the Beixinbao, Lishugou, Nihezi, and Paotaishan sites. In addition, the sand-inclusioned potteries with a reddish-brown slip and mud grey potteries were very common, including the high-necked potteries, Ding, high Dou and so on (Fig. 130a).

The Yuhuangmiao cemetery was dated to the Spring and Autumn period (770-448 BCE) by the principle investigator, Jin Fengyi who proposes the Shanrong tribe as its owner, living in the north of the Yan State during that time according to the Chinese annals. Due to the different cultural ascriptions of the Xibozi and Dongnangou sites, opinions on the date of the Yuhuangmiao culture differ accordingly. Without regard to the Xibozi and Dongnangou sites, the Yuhuangmiao culture falls approximately between the early Spring and Autumn period and the early Warring States period, roughly equal to 800-400 BCE. So far, only one radiocarbon dates (cal. 790-401 BCE, see Appendix) from the Yuhuangmiao culture is in accordance with the chronology that archaeologists proposed. The other three radiocarbon dates (cal. 1088-769 BCE, 2202-1766 BCE, 1219-796 BCE, see Appendix) are out of this range.

In addition, the ethnic attribution, economic subsistence (semi sedentary or pastoral nomadism), origin, and offspring of the Yuhuangmiao culture are still in dispute.

5.4.3 Metal objects

5.4.3.1 Types

The Yuhuangmiao culture was a late bronze culture with an advanced metallurgical industry, distributed north of the Yan State during the Zhou period. The bronze objects of the Yuhuangmiao culture can be divided into two styles: Central Plain-style and local northern style. The former includes ritual vessels such as Ding, Li, Lei, Ye, Dun, and Dou as well as daggers, some horse fittings (Fig. 130b), and some typical patterns of the Central Plain style, such as the Kui-dragon design on the handle of the sword, indicating the influence from the Yan State. The latter is plentiful in types, including

vessels, tools, weapons, personal ornaments and horse fittings (Fig. 130c, A. B. C. D). As we know, the bronze cooking ware-Fu with deep round belly, ring base and double looped ears (Fig. 130c, A1) was one special vessel used by the nomadic person. Such Fu is not only found at the Yuhuangmiao cemetery but also at the Ganzibao and Beixinbao sites. Bronze knives were the most common in quantity in the Yuhuangmiao culture. Among them, the big loop-headed knives with a circular ridge (Fig. 130c, A 10) were seen in most cemeteries. Some knives decorated with saw-teeth patterns or triangular patterns on the handle or with antenna head are regarded as the typical Northern-style bronzes (Fig. 130c, A 3.8.9.18). Another kind of knife with projections on the handle (Fig. 130c, A 19) was also very popular in the Upper Xiajiadian culture and Shiertaiyingzi culture which were distributed mainly in the north of the Yanshan region. It is interesting to note that the bronze awl (Fig. 130c, A 7) was normally combined with bone or wood handles and placed in bronze tubes which are decorated with animal patterns, teeth patterns, check designs, and vein patterns (Fig. 130c, A 2.4.13.14.20). Furthermore, the bronze axes, socketed axes, adzes (Fig. 130c, 5.6.15-17) were also very popular in northern China. It is worth mentioning that the angular-ridged swords with complicated decorations on the handle and antenna heads (Fig. 130c, B 1-11) were quite prevalent in burials. Some curve bladed swords were found as well (Fig. 130c, B 12-14). A large number of personal ornaments made of bronze, gold, agate, turquoise were discovered in burials as well as some stone wares and bone wares. They include belt hooks, buttons, bulbs, earrings, necklaces, beads, and animal-style plaques (Fig. 130c, C). In particular, about two-thirds of the Yuhuangmiao burials have yielded bronze earrings. Many of these personal ornaments are decorated with a variety of animal designs, including the motifs of horses, tigers, deer, fantasy animals and other wild and domestic animals. Furthermore, the well-preserved tombs in the Yuhuangmiao cemetery provide evidence for the function of some ornaments as well.

5.4.3.2 Metallurgical analysis

As mentioned above, we can see that the big bronze vessels were scarce in the Yuhuangmiao culture; knives, swords, and axes were very common; and personal ornaments comprised the majority of the burial goods. A total of twenty-three samples found from Jundushan in Yanqing county (Table 52) were examined with the energy spectrum analysis of scanning electron microscope⁷⁰⁷.

From Table 52, the bronze alloying techniques used in these bronze objects were quite advanced. Firstly, the tri-element alloy with tin as the leading element was popular. In weapons and tools particularly, the average tin content exceeds that of lead, and the tin content is not low, which is in accordance with modern technological principles.

⁷⁰⁷ He/Jin/Wang 2002, 16-21.

For example, the swords contain 12.66% tin and 5.09% lead on average; the knives contain 10.85% tin and 2.48% lead on average; the adzes and axes contain 7.82% tin and 2.52% lead on average. It is worth mentioning that the body of the buckles contain 11-14% tin and 3-6% lead, however the pin-stick of the buckles contain 22% tin and 5-6% lead. All data indicates that advanced metallurgical techniques have been used in such small ornaments. By contrast, the alloy with lead as the leading element was only found in two cases (sample B51 and B52, see Table 52) out of 23 samples. In addition, neither copper nor arsenic and zinc alloy were determined.

So far, 64 samples of the Upper Xiajiadian culture have been examined. Of them, 24 artifacts are Cu-Sn-Pb alloys, and 38 artifacts are Cu-Pb-Sn alloys that contain more lead than tin. Besides, a total of 11 out of 39 swords were Cu-Sn-Pb alloys, 25 are Cu-Pb-Sn alloys⁷⁰⁸. As we know, the strength and hardness of the lead alloy is less than the tin alloy. Accordingly, the alloying techniques used in the Yuhuangmiao culture was more developed than those used in the Upper Xiajiadian culture. Meanwhile, the advanced metallurgy should have met the needs of the growing population.

Lab. No.	Items	Original no.	Sampling position	Composition (%)						Attribution of alloy
				Cu	Sn	Pb	Others			
B38	Cover	YYM2:5	Button	81.2	11.9	6.8				Cu-Sn-Pb
B39	Ding	YYM2:2	Foot	97.5	2.5					Cu-Sn
B40	Axe	YYM13:4	Ring of socket	89.2	8.2	2.4				Cu-Sn-Pb
B41	Knife	YYM175:3	Blade	90.6	8.1	1.2				Cu-Sn
B42	Knife	YYM99:2	Handle	87.5	8.9	3.6				Cu-Sn-Pb
B43	Knife	YC	Blade	87.8	12.1					Cu-Sn
B44	Adz	YYM95:5	Ring of socket	90.8	5.3	3.9				Cu-Sn-Pb
B45	Adz	YYM17:7	Blade	88.9	9.8	1.2				Cu-Sn
B46	Sword	YXM6	Ear on blade	74.8	15.6	5.4	0.9	0.9	1.8	Cu-Sn-Pb
B47-1 -2	Belt hook	282.8	Buckle	71.6	12.7	10.1	1.0	1.7	2.7	Cu-Sn-Pb
			Buckle	70.8	12.7	10.0	1.0	1.7	2.6	
B48-1	Buckle	YYM95:9	Pin stick	71.7	19.3	5.6	1.2	0.3	1.8	Cu-Sn-Pb
-2			Pin stick	66.3	24.4	5.4	1.3	0.8	1.8	
-3			Ring	80.3	10.8	4.7	1.1	0.3	2.7	
-4			Ring	81.1	12.3	2.7	1.2	0.2	2.4	
			Button average	80.7	11.5	3.7				
			Pin stick average	69.0	21.8	5.5				
B49-1	Buckle	YYM95:9	Pin stick	69.9	20.0	6.7	1.4	0.4	1.4	Cu-Sn-Pb
-2			Pin stick	69.0	21.5	5.9	1.3	0.6	1.5	
-3			Ring	77.0	15.0	4.9	0.9	0.2	1.3	
-4			Ring	82.3	11.4	3.5	1.2	0.3	1.3	
			Buckle average	78.9	13.2	4.2				
			Pin stick	69.5	20.8	6.1				

⁷⁰⁸ Zhang/Qu 1982, 194-202.

			average							
B50-1	Buckle	YYM95:9	Pin stick	68.6	21.0	7.3	1.5	0.5	0.9	Cu-Sn-Pb
-2			Pin stick	66.8	24.8	5.0	1.5	0.6	1.2	
-3			Pin stick	71.9	20.0	5.2	1.1	0.5	1.3	
-4			Ring	75.7	16.0	4.2	1.5	0.9	2.1	
-5			Ring	72.9	17.0	6.0	1.9	0.4	1.8	
-6			Ring	82.9	9.1	4.0	1.2	0.2	2.4	
			Buckle average	77.2	14.0	4.7				
			Pin stick average	69.1	21.9	5.8				
B51-1	Girdle cowrie	YYM2:15	Ring	61.6	13.9	19.8	1.9		2.6	Cu-Sn-Pb
B52-1	Arrow head	YYM18:7 (I)	Socket	62.9	16.2	17.6	0.9	0.2	2.0	Cu-Sn-Pb
-2			Socket	50.0	22.1	21.0	1.0	1.5	2.6	
B53-1	Arrow head	YYM18:7 (II)	Tang	78.2	13.0	4.1	2.2	0.3	2.1	Cu-Sn-Pb
-2			Tang	77.1	13.7	4.8	1.5	0.2	2.3	
B54-1	Awl	YYM32:6	Body	84.7	9.3	3.0	0.8	0.4	1.7	Cu-Sn-Pb
-2			Body	84.6	9.2	3.4	1.0	0.3	1.4	
B55-1	Sword	YYM17:2	Blade	80.8	10.3	6.4	0.9	0.3	1.1	Cu-Sn-Pb
-2			Blade	81.9	11.9	3.7	0.9	0.3	1.2	
B56-1	Knife	YYM17:4	Blade	83.2	11.6	3.3	0.6	0.05	1.3	Cu-Sn-Pb
-2			Blade	79.7	13.5	4.3	0.7	0.2	1.6	
B57-1	Bell	YM302:5	Body	90.9	4.5	2.4	1.0	0.1	1.0	Cu-Sn-Pb
-2			Body	90.9	4.5	2.5	1.2		0.9	
B58-1	Bell	YM302:5	Shoulder	84.6	7.9	5.0	0.7		1.6	Cu-Sn-Pb
-2			Shoulder	86.4	7.6	3.9	0.4		1.7	
-3			Shoulder	85.7	7.0	5.1	1.0	0.2	0.8	
-4			Shoulder	85.8	7.0	3.5	0.6	0.2	0.8	
B63	Awl	YYM34:6	Body	82.8	11.2	4.8	1.2			Cu-Sn-Pb
B64	Awl	YYM78	Body	88.6	5.6	5.3	0.5			Cu-Sn-Pb
Average composition (%)	Adz (3)			89.7	7.8	2.5	/			
	Sword (2)			79.2	12.6	5.1	/			
	Knife (4)			85.8	10.8	2.5	/			
	Arrowhead (2)			67.0	16.3	11.9	/			
	Awl (3)			85.2	8.8	4.0	/			
	Bell (2)			88.5	5.9	3.6	/			
	Buckle (3)			78.9	12.9	4.2	/			
				60.2	21.5	5.8	/			
	Cover for vessel (2)			89.4	7.2	3.4	/			
Belt hook (1)			71.2	12.7	10.0	/				

Table 52. Compositional analysis of the bronze objects from Jundushan (adapted from He/Jin/Wang 2002, 18-19 Table 1).

5.5 Summary

Compared to the North-central Complex, the bronze cultures in the south of the Yanshan Complex characterized by a mixture assemblage of both northern-style bronzes and central China style bronzes are more continuous (Fig. 136).

From the late Neolithic to the late Western Zhou period, the Datuotou, Weifang III, and Upper Zhangjiayuan cultures developed successively. There is also a cultural discontinuity during the late Western Zhou period to the early Spring and Autumn period (Fig. 136). Remains from the Dongnangou, Xiaohenan, Baifu, Xibozi sites fill in this gap; however, it is difficult to ascribe them to any culture. At the same time, the bronze cultures in the North-central Complex encountered such a break as well. In addition to the inconsistency of the excavation work carried out, this break may have been caused by some accidental disastrous events at that time.

After the Spring and Autumn period, the Yuhuangmiao culture emerged with splendid metal objects. It is interesting to note that the Yanglang, Taohongbala, Maoqinggou, and Yuhuangmiao cultures seemed to flourish simultaneously from west to east in northern China (Map 24). It was a booming time for northern-style bronzes. Meanwhile, the Yuhuangmiao culture presents its individuality in highly developed bronze swords, belt buckles, and horse and chariot fittings. The metallurgical industry of the Yuhuangmiao culture was highly matured.

Chapter 6 Chronological and cultural framework of bronzes in northern China

From chapter 3 to chapter 5, we can see that each cultural complex in northern China displays different cultural aspects. Besides, they show an imbalance of developments. The Northwest Complex took the lead in entering the Bronze Age, however developed much more slowly than the other complexes in the later period. The North-central Complex and south of the Yanshan Complex present a synchronization of processes with the former being slightly superior to the latter (Fig. 136; Map 24). In terms of Figure 136 and cultural relations discussed in previous chapters, each complex can be roughly divided into three periods. It is worth noting that there is a short time lapse between different periods in the Northwest Complex and the other two complexes. Accordingly, in the following sections, the periodic characteristics of each complex will be analyzed respectively in the first place; the North-central Complex and South of the Yanshan Complex will be analyzed as a unit. Thus, the dynamic development of each complex will unfold before us as well as the consequent varying correlations between them (Fig. 136).

6.1 Northwest Complex

6.1.1 From the late Neolithic to the early Shang period (2300-1500 BCE): the continuity of agricultural economics and the rise of the earliest copper/bronze metallurgy

As the Qijia and Siba cultures arose firstly in northwest China, this area entered the Bronze Age (Map 24). Nevertheless, the pottery-making industry was flourishing and prosperous at that time, while the copper/bronze industry was still in its infancy. By the late period of the Qijia culture, the leading subsistence in this area was based on farming. During this period, this area began to connect with north-central China and the Central Plain, meanwhile the local cultural features revealed themselves gradually.

The middle and west of the Gansu Province and east of the Qinghai Province used to be famous for its agricultural economics during the late Neolithic, especially the Majiaoyao-Banshan-Machang period. The Machang type, characterized by the delicately painted potteries spread to the most western part of the Hexi Corridor and the Tenggeli desert in Inner Mongolia. The Qijia culture, born of the Machang system with its highly developed agriculture, appeared to be largely based on settled farming as well until its late period⁷⁰⁹. This can be proved in several aspects.

⁷⁰⁹Previous research believed that the subsistence of the Qijia culture was largely based on animal husbandry.

Firstly, many remains of the settlements have been discovered. For example, in Qinghai, about 430 sites have been confirmed as belonging to the Qijia culture according to the survey. They are densely distributed within a certain area, especially in east Gansu region where better natural conditions are provided. In the Minhe county, 59 settlements have been found. In fact, settlements of many cultures are always discovered together in one site, not only the Qijia culture, but also the Majiaoyao⁷¹⁰, Kayue, Xindian, and Tangwang-style pottery. Houses were the main component of the settlements, consisting of three types: square houses with white limy clay plastered floor or rectangular houses with burned clay floors, cave dwellings plastered with white limy clay, and houses built with stone walls. The features of the settlements imply that the local people had a relatively settled life at that time.

Secondly, the remains of millet and its impressions on pottery were very common. Thirdly, many tools used for agriculture, including stone knives, axes, sickles, pestles, and mortars were frequently discovered in settlements and rarely seen in burials. Some other tools, such as stone spears, balls, arrowheads, and bone wares imply a certain amount of hunting and fishing at that time. Of the animal bones, pig are the most common; sheep, dogs, cattle and horses come next, indicating that domesticated animals were of great importance. For example, about 800 pig mandibles have been found at the Qijia culture sites, implying a widespread practice of pig-raising and a settled life⁷¹¹.

As for the Siba culture, very little information about the structure of the houses and settlements has been published. At the Huoshaogou cemetery, grains of millet were stored in large pottery jars as burial goods, and the remains of sheep, pigs, horses, and cattle were found in large numbers⁷¹². At the Donghuishan site, carbonized barley, wheat, rye, sorghum, and millet were also found. At the Sibatan site, some pig skulls were uncovered. In general, sheep were most frequently unearthed in the Siba sites. All of the animal and plant remains suggest that the Siba culture was dependent on a mixture of animal husbandry and settled farming⁷¹³.

In fact, scholars hold different opinions on the subsistence of the bronze cultures in the Northwest Complex. Shui Tao proposes that farming economics had totally declined after the late Qijia period, and then the pastoral economics played a leading role in the late bronze cultures in northwest China⁷¹⁴. In this regard, this study does not agree with him. Farming never bowed out of the Northwest Complex, and the farming subsistence mixed with animal husbandry started from the late Qijia period

⁷¹⁰ Including three subtypes: Majiayao, Banshan and Machang.

⁷¹¹ Pak Y. J. 1996, 270.

⁷¹² GSB 1979, 143.

⁷¹³ Pak Y. J. 1996. 282.

⁷¹⁴ Shui T. 2001a, 289-317.

until the end of the Kayue culture⁷¹⁵. This opinion is in accordance with Shang Minjie⁷¹⁶ and Zhang Wenli⁷¹⁷.

Many scholars attribute the change in subsistence to the change of the climate and environment. However, where, when, why, and how much the change of the ancient natural conditions effected the change of subsistence is a difficult issue.

In the metallurgical industry, copper was very popular in the Qijia culture and early Siba culture; arsenic-copper alloy was one of the important characteristics in the late Siba culture as well as tin-copper alloy was very common. This metallurgical process corresponds with Central Asia, however, differs with North-central China, south of the Yanshan, and the Central Plain. In general, the copper/bronze artifacts had not taken the place of potteries. The manufacture and use of the metal objects was still on a small scale.

6.1.2 From the early Shang to the early Western Zhou Period (1500-1050 BCE): the rise of animal husbandry and the initial development of the bronze metallurgy

The Kayue, Xindian, and Siwa cultures were distributed side by side from west to east (Map 24). They coexisted for a long time in northwest China. The second period of the Northwest Complex is equal to the first half part of these three cultures.

After the Kayue culture emerged, this area seems to have had more connections with the outside, in particular with the Central Plain and north-central China. Compared to the first period, the cultural aspects changed greatly. Animal husbandry became more and more important, while pottery remained in daily use and varied from region to region. Bronze metallurgy developed gradually.

As for the subsistence of the Kayue culture, there are four different opinions. One is inclined to believe that the Kayue culture was based on a mixture of farming and fishing, with animal husbandry constituting the main element⁷¹⁸. Shui Tao believes that the Kayue culture was based on farming in the early period, and animal husbandry in the late period⁷¹⁹. Some other scholars hold the view that the subsistence of the Kayue culture differs in regions. The regions near Xining, such as the Panjialiang and Shangsunjiashai sites were based on a farming-pastoral subsistence and farming was relatively weak. The region lying to the west of Xining or far away from Xining represented by the Dahuazhongzhuang site, was supplied by animal

⁷¹⁵ This will be discussed particularly in the following section.

⁷¹⁶ Shang M. J. 1987, 62-70.

⁷¹⁷ ZWL 2003, 87-119.

⁷¹⁸ Yu W. C. 1985a, 193-210.

⁷¹⁹ Shui T. 2001a, 193-327, 309-310.

husbandry, and farming played a minor part. By contrast, in the Ahatela region, animal husbandry was the main means of subsistence though farming still played a great role⁷²⁰. Some scholars think that the owners of the Kayue culture led a pastoral life⁷²¹.

Zhang Wenli did a comprehensive reanalysis on the subsistence of the Kayue culture, based on the attribution of sites, characteristics of the settlements and potteries, and the assemblage of tools⁷²². He concludes that most of the settlements of the Kayue culture were small and discovered from the early to the late period, suggesting a settled life during the whole period. Furthermore, the subsistence differs not only in regions but also in time. Animal victims were more common in the later sites than in the earlier sites. Farming played a bigger role in the east region of the Kayue sites⁷²³. In this regard, this study prefers to agree with Zhang Wenli.

The earliest copper/bronze metallurgy first appeared in northwest China. However, it developed more slowly than expected. The Kayue, Xindian, and Siwa cultures were distributed side by side from west to east (Map 24). All of them lasted for a long time. Actually, the time from the early Shang to the early Western Zhou period is roughly equal to the first half part of these cultures. In contrast to the contemporary bronze cultures in north-central China and south of the Yanshan, their metal objects discovered so far are much simpler in form and technique.

6.1.3 From the early Western Zhou period to the middle Spring and Autumn period (1050-400 BCE): the prevalence of a mixture of farming and animal husbandry, and the disparate development of bronze metallurgy

This period is roughly equal to the last half part of the Kayue, Xindian and Siwa cultures as well as the time when the Nuomuhong, Tangwang-style pottery and Shajing cultures exist (Map 24).

After the late period of the Kayue and Xindian cultures, the connections with the Central Plain seem to have receded, however, the interactive communications with north-central China and the Xinjiang region grew noticeably. Compared to the second period, the regional cultural differences reduced over time, that is, the cultural aspects show great uniformity in the whole area. The pottery industry was on the wane and the bronze metallurgy developed disparately. The bronze artifacts as a unit display many local features. Animal husbandry became the leading subsistence in some areas.

⁷²⁰ Shan M. J. 1987, 62-70.

⁷²¹ Zhou X. 1990, 21-28.

⁷²² ZWL 2003, 94-103.

⁷²³ ZWL 2003, 104.

Scholars hold different opinions on the subsistence of the Xindian culture. Some scholars represented by Xie Ruiju⁷²⁴ and Zhang Wenli⁷²⁵ believed that farming was the leading subsistence in the Xindian culture, animal husbandry was very advanced and hunting also accounted for one part. This study agrees with them because the tools discovered in great numbers at many Xindian sites seem to have been used for farming. Besides, the large quantity of domestic animal sacrifices, including sheep, horses, cattle, dogs, and pigs, suggest that animal husbandry was very developed. The painted potteries of the Xindian culture reached their climax during the late period. However, its bronze metallurgy seems to be inferior to that of the contemporary Kayue culture.

The subsistence of the Siwa culture seems to have been based on a mixture of agriculture and animal breeding. Impressions of grains on the surfaces of pottery, and remains of sacrificed sheep, cattle, goats, and horses provide further evidence⁷²⁶.

It is worth noting that the Nuomuhong, Tangwang-style pottery, and Shajing cultures were born during this period. The Nuomuhong culture experienced both farming and animal husbandry. At the same time, its pottery manufacturing declined after a highly developed stage. Its bronze artifacts show more similarities to those of the Xinjiang region and the Hexi Corridor.

The advanced pottery industry characterized by black painted potteries with purple slip and swirl motifs, and the assemblage of tools suggest that the Tangwang-style pottery should be based on farming. Its bronze metallurgy stays unclear so far.

The Shajing culture is one of the late Bronze Age cultures in the northeast of the Gansu region. Discovery of dwelling sites and cereal as well as stone tools from walled settlements and burials indicate that settled farming was still an important part of the economy⁷²⁷. The bronze metallurgy of the Shajing culture was well advanced. Some of the bronze ornaments display a close resemblance to their counterparts of the late Bronze Age culture in the North-central Complex, suggesting a strong pastoral style.

6.1.4 Summary

Conclusively, 1) the framework of bronzes in the Northwest Complex is complicated and varied. On one hand, it is due to the continuous development of the local cultures;

⁷²⁴ XRJ 2002.

⁷²⁵ ZWL 2003, 109-111.

⁷²⁶ Pak Y. J. 1996, 314.

⁷²⁷ Pak Y. J. 1996, 322.

on the other hand, it is attributable to the influence and impact from outside. The local features as a unit are very distinctive from the beginning to the end. After the Qijia culture, local features were passed over through the Siba, Kayue, Xidian, Siwa, and Nuomuhong cultures. In particular, the burial patterns, bronze artifacts, and subsistence display great local characteristics.

2) The subsistence of the Northwest Complex was a mixture of farming, animal husbandry and hunting. The proportion of subsistence changes over time and varies from region to region. Farming never disappeared and animal husbandry increased gradually after the late Qijia culture.

This study does not believe that pastoral subsistence played an important role in the Northwest Complex. As we know, the rise of pastoral subsistence was dependent on lots of domestic horses. Apart from several cases of horse sacrifices in the burials of the late Kayue culture, horses were rarely discovered in the tombs. Moreover, we cannot tell whether the horse that have been found were domestic horses. Besides, horse fittings were hardly found in the burials or settlements. Consequently, we have not enough evidence to prove that the local people relied mainly on the pastoral subsistence at that time.

Regarding the reason or cause for the change of subsistence, scholars hold different views. Zhang Wenli has a good explanation on this issue. It was not only due to the development of the production capability but also to the change of the natural conditions. Advanced agriculture during the Neolithic period may have urged the growth of the population. Once the population expansion exceeds the supporting capacity of the agricultural economics, it will push some people to leave the old settlement in order to explore new settlements or a new means of subsistence. This exploring process will last for a long time. Nevertheless, the change of the climate and environment will promote this process⁷²⁸. For instance, the Liuwan cemetery lasted over 600 years, containing burials from the Banshan period to the Qijia culture. According to Table 53, we can see that the population reached its maximum during the Machang period at the Liuwan cemetery and decreased sharply after the Qijia culture. However, Shui Tao explains this phenomenon in another way. He puts forward that the catastrophic change of climate led to the thorough decline of agriculture as well as the rise and development of animal husbandry⁷²⁹. On this issue, the explanation of Zhang Wenli seems more reasonable. Besides, as discussed before, this study believes that farming played a great role even when the animal husbandry was used as a means of basic subsistence.

⁷²⁸ ZWL 2003, 115-116.

⁷²⁹ Shui T. 2001a, 308-311.

amount period	type single burial (number)	joint burial						Total (person)
		2 person	3 person	4 person	5 person	6 person	7 person	
Banshan period	224	12 × 2	10 × 3	2 × 4	4 × 5	4 × 6	1 × 7	337
Machang period	769 + 59	27 × 2	10 × 3	2 × 4	1 × 5	4 × 6		949
Qijia culture	343	20 × 2	1 × 3	1 × 4	1 × 5			395
Xindian culture	5							5

Table 53. Population size during different periods at the Liuwan cemetery (adapted from Shui T. 2001a, 290 Table 18). Remark: 59 bad-preserved tombs are ascribed to single burials.

3) In fact, the development of bronze metallurgy is comparatively slow within the Northwest Complex, though it appeared much earlier in northern China. Bronze artifacts were usually composed of small-scale tools, weapons, and ornaments, including knives, awls, arrowheads, joined beads, plaques, bulbs and so on. Only several big-scale bronze artifacts were found in the late Siwa culture. Of them, the daggers-Ge (Fig. 103b, 35.38) may have been introduced from the Central Plain. The Xigang and Chaiwangang sites of the Shajing culture produced a great number of northern-style bronze ornaments (Fig. 098a-f; Fig 064a-h), implying increasing connections with the North-central Complex. Nevertheless, in general, the bronze artifacts in the Northwest Complex had not taken the place of potteries, and the bronze metallurgy had not reached its climax compared to its eastern regions.

6.2 North-central Complex and south of the Yanshan Complex

6.2.1 From the early Xia period to the late Shang period (1900-1250 BCE): the continuity of the agricultural economics and the rise of copper/bronze metallurgy

The Zhukaigou culture in north-central China was roughly parallel to the Datuotou culture in the south of the Yanshan Complex (Map 24). They share certain common characteristics in subsistence and bronze objects.

The subsistence of the Zhukaigou culture is complicated. A great number of data suggests that agricultural economics played a great role throughout the Zhukaigou culture. For example, pig sacrifices were very common in burials throughout the entire period of occupation at the Zhukaigou site, indicating extensive pig raising and possibly a surplus production of grains for pig feed (Table 54, Table 55). According to Huang Yunping, some bones of pig found at the Zhukaigou site display features of domestic pigs⁷³⁰. In addition, sheep and cattle may have been herded in large numbers. Beside, advanced pottery making and many tools used for farming imply a settled life

⁷³⁰ Huang Y. P. 2000, 400-421.

in the Zhukaigou site.

Stage	Amount	pig	cattle	sheep	dog	wild animal	total
V	measured amount	2	1	1	0	0	4
	expected amount	1.32	0.61	1.43	0.18	0.46	
	discrepancy	0.68	0.39	0.43	-0.18	-0.46	
IV	measured amount	4	5	8	2	5	24
	expected amount	7.95	3.67	8.56	1.07	2.75	
	discrepancy	3.95	1.33	0.56	0.93	2.25	
III	measured amount	19	4	15	3	3	44
	expected amount	14.57	6.73	15.69	1.96	5.04	
	discrepancy	4.43	2.73	0.69	1.04	-2.04	
II	measured amount	19	10	27	1	10	67
	expected amount	22.19	10.24	23.9	2.99	7.68	
	discrepancy	3.19	0.24	3.1	1.99	2.32	
I	measured amount	8	4	5	1	0	18
	expected amount	5.96	2.75	6.42	0.8	2.06	
	discrepancy	5.04	1.25	-1.42	0.2	-2.06	
	total	52	24	56	7	18	157

$$\chi^2 = 22.685$$

Table 54. Amount of different animals found at the Zhukaigou site (adapted from Huang Y. P. 2000, 420 Table 13).

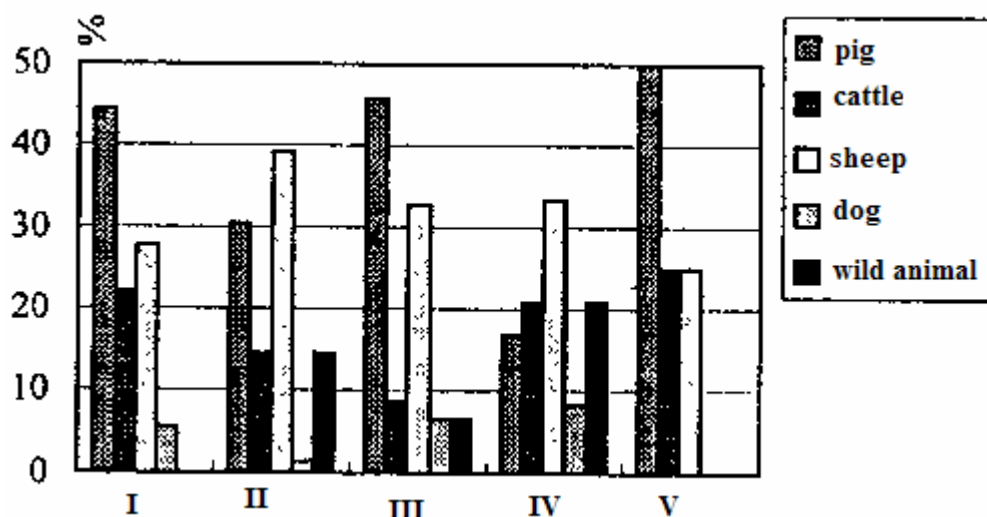


Table 55. Animal percentage during different stages at the Zhukaigou site (adapted from Huang Y. P. 2000, 420 Fig. 6).

Some scholars believe that agriculture was the main source of subsistence for the local people, from the second to the fourth stage at the Zhukaigou site; meanwhile, animal husbandry kept growing over time. After the fifth stage, semi-agricultural and semi-

pastoral subsistence dominated⁷³¹. However, from Table 54 and Table 55, we can see that the ratio of each animal doesn't differ much in each period. In fact, the total amount of animals decreased after the fourth stage. Therefore, this study does not think that the animal evidence testifies to the rise of pastoral economics in the late Zhukaigou culture.

The owners of the Datuotou culture may have relied on agriculture, which can be proven in many aspects. 1) the stone tools consisting of spades, sickles, axes, knives, adzes, hammers, chisels, and so on are typically used for agricultural purposes; 2) pig bones were discovered in some sites; 3) the discoveries of some settlements and advanced pottery making suggest a relatively settled life. In addition, the pottery spinning whorls, pottery net plummet, and the burial practice of cattle, sheep, and wild animals, indicate a certain amount of fishing and hunting subsistence as well.

As mentioned before, if we compare the copper and bronze objects found from the Qijia (Fig. 099b) and the Siba cultures (Fig. 104b) to the metal objects found from the Zhukaigou (Fig. 108c) and Datuotou cultures (Fig. 111c), some metal objects show great similarities. For instance, in addition to the bronzes in the Central Plain style (Fig. 108c, 16-19), the bronze knives, arrowheads, and earrings in the Zhukaigou culture (Fig. 108c, 1, 5-12) can be traced back to the Siba culture (Fig. 104b, 1-31). The earrings found in the Qijia and Siba cultures may very well be the prototype of the remarkable earrings found in the Datuotou culture.

Copper, tin-copper alloy and tin-lead-copper alloy were very popular in the Zhukaigou culture. By contrast, copper, arsenic-copper alloy, and tin-copper alloy were popular in the Qijia and Siba cultures. Accordingly, the Zhukaigou and Datuotou cultures may have had their own metallurgical industry, though heavily influenced by the northwest. The discovery of a stone mold for an axe and some slag in the Datuotou culture provides further evidence for this opinion as well.

In general, agricultural subsistence was still very significant for the people of the Zhukaigou culture and Datuotou culture. At the same time, the local metallurgy may have come into being during this period. However, the types and forms of the copper/bronze objects indicate a strong influence from the outside, especially from northwest China.

⁷³¹ Beifangcaoyuan 2007, 81; Zhukaigou 2000.

6.2.2 From the late Shang period to the middle Western Zhou period (1250-900 BCE): the prevalence of a mixture of economics: farming, animal husbandry, and hunting, and the development of the northern-style bronzes

When compared to the first period, the North-central Complex and south of the Yanshan Complex share more similarities in cultural aspects, especially in bronze assemblages. However, the bronze objects had not replaced the role of potteries and pottery making was still very popular and well developed. The mixture of farming, animal husbandry, and hunting seems to have been very prevalent during this period. The Lijiaya, Xicha, Weifang III, and Upper Zhangjiayuan cultures will be included (Map 24).

The people of the Lijiaya culture seem to have led a settled life. Many remains of settlements were discovered, including city walls, houses, and pits. The bronze adzes, stone axes, knives, chisels, bone spades and knives have visible marks for being used on their blades. A 10cm-thick millet was found in the base of one pit. Animal bones were very common in settlements and burials, including horses, cattle, sheep, pigs, dogs, deer, and wild animals. In addition, the patterns of tigers, deer, sheep, snakes, and frogs were frequently adorned on the bronzes. Pottery making was still very popular. All of this data suggests a settled farming subsistence mixed with animal husbandry and hunting. As for the Xicha culture, due to inadequate materials, it is difficult to discuss its subsistence⁷³².

The subsistence of the Weifang III and Upper Zhangjiayuan cultures are the same as the Lijiaya culture, based on a mixture of farming, animal husbandry, and hunting. Discoveries of some pottery spindle whorls and net plummet in the Upper Zhangjiayuan culture implies a certain amount of fishing as well.

In general, the bronze assemblages of the North-central Complex and south of the Yanshan Complex present striking similarities, especially to the Lijiaya culture and the Weifang III culture. From Fig. 109b and Fig. 112b, the bell-shaped head, animal-shaped head, bow-shaped objects, and ritual vessels were very common in both cultures. It is possible that the local people had not only produced metal objects on a larger scale, but have also grasped skilled manufacturing techniques. The delicate bronze objects characterized by a mixture of styles, and the discoveries of the stone or pottery molds provide strong evidence.

6.2.3 From the early Spring and Autumn period to the end of the Warring States (800-200 BCE): The prosperity of animal husbandry and flourishing of the

⁷³² Beifangcaoyuan 2007, 156.

northern-style metal objects

After a short break from the late Western Zhou period to the early Spring and Autumn period, a full-scale prosperous time for the northern-style bronzes commenced after the early Spring and Autumn period. Animal husbandry became the basic means of subsistence, and pastoral life was very popular during this period.

The Yanglang culture, Taohongbala culture, Maoqinggou culture, and Yuhuangmiao culture were distributed from west to east (Map 24), and shared many common characteristics, such as animal sacrifice, splendid metal objects in a strong pastoral style, and so on. As discussed before, they distinguished themselves by their burial patterns, bronze assemblages, and subsistence as well⁷³³.

The earth shaft pit with a side pit was only seen in the burials of the Yanglang culture. Another unique feature of the Yanglang culture was an abundance of bone wares, including weapons, horse and chariot fittings, and personal ornaments. So far, no remains of settlements have been identified as belonging to the Yanglang culture. Only a few potteries were found. The metal objects and animal patterns on the metal objects of the Yanglang culture show close relations to the Taohongbala culture, especially in antenna-pommel swords, crane hacks, plaques with animal patterns and so on. However, some iron swords, bronze spears, pole tops, and deer shaped plaques were hardly seen in the Taohongbala culture.

Located in the west and east of north-central China respectively, both the Taohongbala culture and Maoqinggou culture had highly advanced northern-style bronzes with antenna-pommel swords and ornaments with varied animal motifs (Fig. 131b-131c; Fig. 134a-134e). Moreover, they had their own peculiarities as well. For example, in contrast to the large-scale cemetery that was found in the Maoqinggou culture, burials were only scattered in the Taohongbala culture, implying that the people of the Taohongbala culture may have led a more nomadic life. In addition, some tombs lying in a north-south direction at the Maoqinggou site differ greatly from the tombs lying in an east-west direction in both burial patterns and burial goods, and the latter probably belonged to people from the Central Plain. In addition, the Taohongbala culture had more delicate gold and silver objects than the Maoqinggou culture. However, more iron objects were discovered throughout the Maoqinggou culture.

Compared to the Yanglang, Taohongbala, and Maoqinggou cultures, the Yuhuangmiao culture was unique. Firstly, it absorbed certain elements from the Upper Xiajiadian culture that was located north of the Yanshan, such as the bronze swords with a curved

⁷³³ The slight difference in subsistence will be discussed in the following Chapter 6.2.3.

blade (Fig. 130c, B 12-14) and the face-masking mortuary practice, which are not seen in the other three cultures. Secondly, many bronze objects were very common in the Central Plain (Fig. 130b), such as the ritual vessels, daggers, horse and chariot fittings, and dragon pattern, implying the impact from the Central Plain. Of course, the northern-style metal objects were very advanced in the Yuhuangmiao culture as well (Fig. 130c).

In addition, animal husbandry was the basic means of subsistence during this period; however, farming had not entirely declined, and it was still used as a part of minor subsistence in the east region. The people of the Yanglang culture and Taohongbala culture seem to have had a pastoral nomadic life. The absence of the settlements and farming tools suggest a decline in agriculture, while animal sacrifice consisting of horses, sheep, and cattle, and many metal horse and chariot fittings point to the importance of animal husbandry at that time. By contrast, the people of the Maoqinggou culture and Yuhuangmiao culture may have led a semi-settled and semi-pastoral life, which can be proven in several aspects. Firstly, a large-scale cemetery is normally related to the settlement, implying a settled life. Secondly, in addition to the horses, cattle, and sheep found, pigs and dogs were also seen in these two cultures, indicating the possibility of farming. Thirdly, the mortuary practices and burial goods of the tombs lying in a north-south direction at the Maoqinggou cemetery were the same as the tombs in the Central Plain, which were dependent on farming.

6.2.4 Summary

In general, 1) It was during the late Western Zhou period to the early Spring and Autumn period that both the North-central Complex and south of the Yanshan Complex encountered a similar cultural discontinuity.

2) The copper/bronze metallurgy of these two complexes appears later than that of the Northwest Complex. Some of the early metal objects display many similarities to those from the Northwest Complex, implying the possible influence from the northwest. However, the early copper/bronze metallurgical techniques differ with those of the northwest. Moreover, the metallurgy industry developed very fast and reached its climax after the Spring and Autumn period.

3) Before the late Western Zhou period, farming was the basic means of subsistence for the local people. Until the Spring and Autumn period, animal husbandry played a leading role; however, not all people led a pastoral nomadic life. For instance, the people of the Maoqinggou and Yuhuangmiao cultures were still based on a semi-pastoral and semi-agricultural subsistence.

4) The contemporary bronze cultures in these two complexes share some common features regarding cultural aspects. In addition, the common features grew over time and reached their maximum from the Spring and Autumn period to the late Warring States period.

6.3 Interactive relations between complexes

In the process of cultural development, bronze cultures in each complex kept communicating with each other. Generally, the relations between the North-central Complex and south of the Yanshan Complex were much closer than the relations between the Northwest Complex and its eastern complexes. The interactive relations between complexes can be roughly divided into two periods.

The early period was approximately from the second millennia BCE to the late Shang period. During this period, the Northwest Complex had more influence on the other two complexes. The Qijia and Siba cultures spread through the Hexi Corridor and Yinshan to the Zhukaigou and Datuotou cultures. The communications were not one-way. Of course, the bronze cultures in north-central China and south of the Yanshan region spread to or influenced the northwest of China too. For instance, Li-tripods with serpent patterns, one of the typical potteries in the Zhukaigou culture (Fig. 108a, 1-5) were also found in the Gansu region.

The late period was roughly from the late Shang period to the late Warring States period. During this period, when the impact from the Northwest Complex reduced, the force of the North-central Complex and south of the Yanshan Complex increased. After the Spring and Autumn period, the North-central Complex reached its climax gradually and the connections between the North-central Complex and south of Yanshan Complex grew. Compared to the North-central Complex and Northwest Complex, south of the Yanshan Complex was more influenced by the Central Plain. In addition, the pastoral nomadic life based on prosperous animal husbandry at that time may have promoted the connections between the cultures. Thus, the contemporary bronze cultures share more common features.

Chapter 7 Relations with the neighboring cultures

As mentioned in the previous chapters, the bronze cultures in each complex kept communicating with each other. They contacted the neighboring bronze cultures in the Central Plain, the Xinjiang region, and the Eurasian Steppe as well. The internal and external associations and exchanges promoted cultural propagation and merging, which can be recognized from archaeological evidence. This chapter will focus on the bronze metallurgy in order to see an overall view of the cultural development in these related regions.

7.1 Relations with the Central Plain

7.1.1 The rise of the dynasties in the Central Plain

Before discussing the relations of northern China and the Central Plain during the 4th and 3rd millennia B. P., it is necessary to have a brief introduction on the foundation and expansion of the dynasties in the Central Plain. The Shang Dynasty was a historic Chinese dynasty and ruled in the northeastern region of an area known as ‘China proper’ in the Yellow River valley (Map 25). The Shang Dynasty followed the quasi-legendary Xia Dynasty and preceded the Zhou Dynasty. The last Shang ruler, a despot according to standard Chinese accounts, was overthrown by a chieftain of a frontier tribe called Zhou, which had settled in the Wei Valley in the modern Shaanxi Province (Map 26). In 771 BCE, the Zhou court was sacked, and its king was killed by invading barbarians who were allied with rebel lords. The capital was moved eastwards to Luoyang. Because of this shift, historians divide the Zhou era into Western Zhou (1027 to 771 BCE) and Eastern Zhou (770 to 221 BCE). With the royal line broken, the power of the Zhou court gradually diminished, and the fragmentation of the kingdom accelerated. Eastern Zhou divides into two sub periods (Map 27). The first, from 770 to 476 BCE, is called the Spring and Autumn Period, after a famous historical chronicle of that time; the second is known as the Warring States Period (475 to 221 BCE). The Warring States Period, in contrast to the Spring and Autumn Period, was a period when regional warlords annexed smaller states around them, in order to consolidate their rule. The process began in the Spring and Autumn period, and by the 3rd century BC, seven major states had become prominent. These Seven Warring States (战国七雄 Zhanguo Qixiong, literally ‘Seven Hegemonial among the Warring States’), were the Qi (齊/齐), the Chu (楚), the Yan (燕), the Han (韓/韩), the Zhao (趙/赵), the Wei (魏) and the Qin (秦) (Map 28). Another sign of this shift in power was a change of title: warlords still considered themselves dukes (公 *gōng*) of the Zhou dynasty king; but now the warlords began to call themselves kings (王 *wáng*), meaning they were equal to the Zhou king.

Information about these dynasties comes from historical records of the later Zhou Dynasty, the Han Dynasty *Shiji* (史记) by Sima Qian, and from Shang inscriptions on bronze artifacts (金文) and oracle bones (甲骨文)— turtle shells, cattle scapulae or other bones on which were written the first significant corpus of recorded Chinese characters. However, on one hand, the inscriptions on bronze artifacts and oracle bones record a meager account on the northern tribes; on the other hand, ancient scholars and scholars of today differ on the account of the northern tribes in ancient documents; some tribes are not even recorded. Therefore, it is hard to understand how central China and northern China communicated with each other in terms of economics, cultures, and so on. In order to solve such difficulties, archaeological evidence is without doubt the best efficient way to do so. This study will place an extra emphasis on the bronze metallurgy.

From Map 25 to Map 28, we can see that north central and south of the Yanshan region borders extensively on the territory of the central dynasties in the south, within the earlier period. During the later period, the subinfeudated Yan State centered in the Beijing region had occupied the northern Hebei region where the south of the Yunnan Complex was distributed. Furthermore, the subinfeudated Zhao State had entered the Shanxi and northeast Shanxi region where some bronze cultures of the north-central Complex were located. Moreover, the subinfeudated Qin State controlled the Ningxia and east Gansu region. In fact, how much northern China was influenced by the Central Plain is closely interrelated to how strong the central dynasties were. This can be proven if we compare the elements from the Central Plain in the North-central Complex and South of the Yanshan Complex from the beginning to the end. However, the bronze cultures in the Northwest Complex do not seem to have had any direct contact with the central Dynasties. Therefore, its slightly inconspicuous connections with the Central Plain will not be mentioned here.

7.1.2 Relations between North-central China and the Central Plain

7.1.2.1 Ningxia and east Gansu region

The Pre-Zhou culture was first put forward in the 1940s after the remains of the Baoji site in the Shaanxi Province⁷³⁴. Since the liberation, similar kinds of remains were found in the Qingyang and Pingliang region, Gansu province. In fact, the main territory of the Pre-Zhou culture was centered in east Gansu (Map 29) where many settlements and burials of the Shang and Zhou culture have been identified⁷³⁵.

⁷³⁴ Su B. Q. 1984, 143-189.

⁷³⁵ Shui T. 2001a, 259.

The Central Plain style bronze objects found in the eastern Gansu and Ningxia region, from the Shang to the Western Zhou period mainly consist of all kinds of cups and vessels (Fig. 137), including cup-Jue, cup-Gu, cup-Hu, tripod-Ding, vessel-Gui, vessel-He and so on. Most of them were discovered from burials. According to Fig. 137, it seems that the influence from Central China reached its climax during the early Western Zhou period, and only a tiny quantity of such bronzes were identified in the middle and late Western Zhou period, which is probably related to the eastwards movement of the political center of the Western Zhou Dynasty.

After the Spring and Autumn period, lots of the Central Plain style metal objects re-emerged in greater numbers in the east Gansu and Ningxia regions. The Chinese scholar, Yang Jianhua, has carried out a comprehensive study on the relations between the Central Plain and northern China, from the Spring and Autumn period to the late Warring States period. She divides northern China into six sub-regions: the Guyuan region, Qingyang region, west Inner Mongolia, east Inner Mongolia, and north Hebei (Fig. 138), which are approximately equal to the Yanglang culture⁷³⁶, Taohongbala culture, Maoqinggou culture, and Yuhuangmiao culture respectively as addressed in this study.

According to Fig. 138, some chariot fittings, daggers, belt hooks, and plaques in the Central Plain style were discovered in the Guyuan and Pingliang regions (Fig. 138, 6.10-13.22-25). On the plaques, we can see a merging of the Central Plain pattern with the *Kui*-dragon design. Furthermore, animal sacrifice, which was quite widespread in the frontier was not found here; instead, the entire horse was frequently buried in the tombs. This data implies that the traditions of this region were somehow connected to those of the Central Plain. However, no bronze ritual vessels have been found so far. As summarized by Yang Jianhua, the Guyuan region was similar to the east Inner Mongolia region in Ge and belt buckles. However, the number of belt-buckles increased in the east Inner Mongolia region.

7.1.2.2 The west and east Inner Mongolia region

The west and east of Inner Mongolia was where the North-central Complex was most developed. The Zhukaigou culture, the earliest bronze culture in this complex displays some influence from the Central Plain, which is fully reflected in the remains of a dwelling place, potteries, and bronze objects. In addition to some pots such as Dou and Gui (Fig. 108b, 9-10) bearing the sign of the early Shang style, the bronze vessel-Ding, the glutton motif on bronzes, and straight-bladed daggers (Fig. 108c, 16-19) show great similarities to those in the early Shang culture as well.

⁷³⁶ Including both of the Guyuan region in Ningxia and the Qingyang region in Gansu.

Compared to the Zhukaigou culture, the Lijiaya culture shows closer connections to the Shang culture. As counted by Wu En, over 250 bronze artifacts in the Shang style were discovered in the burials and hoards of the Lijiaya culture⁷³⁷ (Fig. 109b, 27-32). Not only the forms but also the decorative patterns were almost the same as those found at Yinxu. Regarding the source of these bronzes, this study prefers to believe that they were exchanged by trade in a relatively peaceful period between the northern people and central people. In addition, some potteries and bronze arrowheads characterized by the early Western Zhou style indicated the close relations between the Lijiaya culture and the early Western Zhou culture as well.

Until now, no elements from the Shang or Zhou cultures have been identified in the Xicha culture. Furthermore, no high-grade tombs have been excavated. Therefore, it is hard to tell whether there was a spiritual influence from the Central Plain. In short, there is not any direct evidence to prove that Central China affected the Xicha culture.

After a short break during the late Western Zhou period, two typical northern bronze cultures ‘Taohongbala’ and ‘Maoqinggou’ emerged respectively in west and east Inner Mongolia, after the Spring and Autumn period. Compared to the earlier period, the influence from central China reduced. In west Inner Mongolia, except for two bronze vessels in the Eastern Zhou style bronze vessels found in the earlier stage (Fig. 138, 1.2), other influences from the Central Plain culture were rarely seen. Engraving Chinese characters on bronze artifacts (Fig. 138, 7) was a practice of the artisans during the Warring States period (for recording its maker or the weight etc.). It is possible that these objects could have been made by the artisans from the Central Plain who were probably captured by the northern tribes⁷³⁸. Such phenomena can be found in historical records⁷³⁹. In addition, metal weapons, tools, and ornaments in the Central Plain style were rarely seen.

Only a small quantity of weapon-Ge, arrowheads, and belt hooks characterized by the Central Plain style (Fig. 138, 14.15.26.27) were found in the Maoqinggou culture. However, some tombs in a south-north direction, built with a wood coffin, and buried without animal sacrifices were quite different to other tombs lying in an east-west direction. They probably belonged to the people from the Central Plain.

⁷³⁷ Beifangcaoyuan 2007, 157.

⁷³⁸ YJH 2004, 217.

⁷³⁹ <史记·赵世家>: 赵武灵王 ‘西略胡地，至榆中，林胡王献马’。The Lord Ling of the Zhao State once invaded the area where the Hu people lived, even into the Yuzhong region. Therefore, the king of the Hu offered horses. This record indicates there were wars between the Hu people and central people. The Yuzhong region is roughly equal to the Ordos region. Consequently, it is possible that the artisans from central China were captured by the northern tribes.

7.1.3 Relations between the South of the Yanshan and the Central Plain

As mentioned before, the bronze artifacts of the Datuotou culture show a strong influence from the Northwest Complex (Fig. 111c). No typical bronze from the Central Plain was found in the Datuotou culture. However, the potteries display close relations to the early, middle, and late Shang culture (Fig. 111a), such as tripod-Li, Gui, Yan, and so on. Yang Jianhua puts forward that the south of the Datuotou culture was more influenced by the Shang culture. By contrast, the north of the Datuotou culture had more local features.

In addition to some potteries in a strong Shang style (Fig. 112a), the bronze artifacts in the Weifang III culture present close connections with the Central Plain as well. Dozens of the bronze ritual vessels have been found, such as Ding, Gui, Yan, Lei, He and so on as well as some Chinese inscriptions on bronzes (Fig. 112b, 17-22). At the same time, some typical northern-style bronzes were found in the Central Plain too, such as socketed axes, animal headed knives, and bow shaped objects with animal or bell heads (Fig. 112c).

The close relations between the Upper Zhangjiayuan culture and the Yan culture of the Western Zhou are mostly reflected in the potteries (Fig. 117a). The bronze assemblages of the Baifu, Dongnangou, Xibozi, and Xiaohenan sites provide evidence for the complicated relations between the south of the Yanshan region and central China.

After the Spring and Autumn period, a large number of the Central Plain style vessels were found in northern Hebei, which was rarely seen in other regions. There were also cart gears, tools, weapons, and decorative patterns such as Ge, arrowheads, swords, knives, and ornaments such as belt hooks (Fig. 139a, 4.5.9.16-21.28; Fig. 130b). It is possible that the 'Central Plainized' (中原化) elites of the Hebei region simulated rituals of the Central Plain and used their ritual vessels. As a result, the Yan culture replaced the northern bronze culture gradually in this area.

7.1.4 Political interaction

In general, the cultures in the Northwest Complex were seemingly more connected with cultures to their west, which will be discussed in section 7.3. They never established centrally managed state-level societies, and remained outside the Chinese cultural and political dynastic arena until the Qin conquered these lands circa the fifth century BCE. This area does not seem to have been inspired by the Central Plain, regarding bronze metallurgy or much of anything else detectable in the archaeological record. Their knowledge of horses and of certain metal tools was probably imported

into the Central Plain eventually⁷⁴⁰. During the Shang to the late Western Zhou period, the east Gansu and Ningxia regions, and south of the Yanshan region absorbed only bronze ritual vessels from central China. At the same time, the west and east Inner Mongolia region accepted not only bronze ritual vessels, but also weapons. However, after the Spring and Autumn period, only a number of bronze daggers-Ge and belt hooks in the Central Plain style were discovered in the east of the Gansu and Ningxia regions, and the ritual vessels were absent. Simultaneously, not only ritual vessels but also weapons and horse fittings in the central style were found in the west and east of the Inner Mongolia region. Moreover, south of the Yanshan region seems to have been Central Plainized.

This phenomenon can be understood as follows: when the Shang and Western Zhou Dynasty arose, the elite people in the east Gansu and Ningxia regions may have imitated the ceremony systems from central China; however, the people living in the west and east Inner Mongolia may have had more connections with central China via war or trade. After the Spring and Autumn period, the wars between northern China and the Central Plain became more frequent. Therefore, bronze weapons in the central style were very common in northern China. With the development of animal husbandry, the power of the northern people was enforced gradually. Accordingly, it was possible for the north-central people to rob some artifacts or capture some people from central China instead of that the central dynasties invaded north-central China.

Each region might have optionally adapted or borrowed different traits from the Central Plain culture, nevertheless, the widespread of dagger-Ge (Fig. 138, 10-13.1.17.18) suggests that the interactions between northern China and the Central Plain were mainly through warfare. The Great Wall may be the best evidence for this. Political interactions between northern China and the Central Plain were reflected by the construction of the Great wall as well. This showed that the States in the Central Plain used the 'Wall' to defend themselves from the 'horses' of the northern tribes. From historical records, we know that the construction of the Great Wall by Yan, Zhao, and Qin, took place during the rule of Lord Zhao of the Yan State (燕昭王), the rule of Lord Wuling of the Zhao State (赵武灵王), and Lord Zhaoxiang of the Qin State (秦昭襄王). Therefore, the Great Wall of the Zhao and the Yan State were built during the middle and late Warring States period, and the Great Wall of the Qin State was built during the late Warring States period⁷⁴¹.

If we mark the orientation of the Great Wall constructed during the Warring States, as mentioned above, and the geographic locations of sites discovered in northern China

⁷⁴⁰ Linduff et al. 2000, 21.

⁷⁴¹ YJH 2004, 218.

on the same Map (Map 29), we can observe the association between them: towards the east end, the Great Wall is located further north; towards the west end, the Great Wall is located further south, and the Great Wall in the Guanyuan region had already cut through the middle of northern China.

The orientation of the Great Wall (Map 30) is roughly in accordance with the scale of influence from the Central Plain. In addition, the construction of the Great Wall established the northern zone and became the landmark of the northern frontier belt. On the other hand, it forced northern China, which was dominated by local ethnic cultures to be split into two groups. Cultures located on the south side of the Great Wall became part of the Central Plain culture; while those in the north attached themselves to the Eurasian Steppe cultures, which were located further north, thus a greater tribe confederacy formed in order to deal with the united Qin Empire.

7.2 Relations with the Xinjing region

7.2.1 The Bronze Age and Iron Age cultures in Xinjiang

Xinjiang, the most western provincial region of China, situated in Central Asia, is well known as an important crossroads on the ancient Silk Route⁷⁴². The central role of Xinjiang in the later prehistory of Eurasia is only gradually being appreciated (Map 31). To many western scholars, it seems at first a very remote region indeed, containing the inhospitable Taklamakan Desert, first made known to western scholars through the explorations of the intrepid Aurel Stein and his contemporaries in the first quarter of the twentieth century. For Chinese scholars also, one suspects, that this area may seem quite remote, far to the west of the major sites of imperial China, and thus peripheral to the heartlands of the empire. Yet Xinjiang was a nub, a focal point in the communication between east and west. Across it, to the north and south of the Taklamakan Desert, lay the most eastern components of the Silk Road⁷⁴³.

Before we discuss the relations between Xinjiang and northern China, it is necessary to have a rudimentary grasp of the contemporary cultures in Xinjiang. Chinese scholar, Mei Jianjun offered a coherent study on the later prehistory of Xinjiang and its early development of metallurgy in the Bronze Age⁷⁴⁴. On the basis of previous research, he proposed a cultural framework for Xinjiang (Table 56; Table 57) and summarized the metallurgical connections between Xinjiang and the Northwest Complex⁷⁴⁵. Another

⁷⁴² The term 'Silk Route' was first proposed by Richthofen in 1877, and then generally accepted, to describe the trade route between China and the West, which was traditionally thought to be opened during the 2nd century BCE. There is, however, a growing body of archaeological evidence that the Silk Route had served as a bridge of cultural interaction between China and the West long before the date hitherto assumed.

⁷⁴³ MJJ 2000, iii.

⁷⁴⁴ MJJ 2000.

⁷⁴⁵ MJJ 2000, 61-66.

Chinese scholar, Yang Jianhua, did a comparative study on the relations between Xinjiang and northern China⁷⁴⁶ from the Spring and Autumn period to the late Warring States⁷⁴⁷. Therefore, this study will have an all-round discussion based upon the above mentioned research.

Regions	Cultural Groups and Major Sites	
	Bronze Age	Iron Age
The Eastern Pamirs	<i>Suletangba'e</i> <i>Aketala</i> : Halayüergun	<i>Xiangbaobao</i>
The Eastern Rim of the Tarim Basin	<i>Gumugou</i>	
The Southern Rim of the Tarim Basin		<i>Zahongluke</i> (Keriya ?)
The South Foot of the Tian Shan	<i>Xintala</i> : Quhui <i>Haladun</i>	<i>Chawuhugou</i> <i>Qunbake</i> <i>Baozidong</i>
The Turfan Basin	<i>Halahezhuo</i>	<i>Aidinghu</i> : Subashi; Yanghai; Kageqiake
The Hami Basin	<i>Tianshanbeilu</i> <i>Wupu</i> <i>Yanbulake</i> *: Lafuqiako	<i>Hanqigou</i> <i>Miao'ergou</i>
The North Foot of the Tian Shan	<i>Nanwan</i> *: Lanzhouwanzi; Shirenzi; Ka'ersang <i>Sidaogou</i> *: Banjiogou <i>Shuinichang</i>	<i>Dalongkou</i> : Dacotan
Northwest Xinjiang: Tacheng & Ili river valley	<i>Aga'ersen</i> : Sazi; Weixiao	<i>Tiemulike</i> : Suodunbulake; <i>Zhongyangchang</i> ; Nulasai; <i>Yimuchang</i> ; Heishantou <i>Xiatai</i>
Altai Mountains	<i>Ke'ermuqi</i> *	
The Valleys of the Middle Tian Shan		<i>Alagou I</i> : Dongfengchang <i>Alagou II</i> <i>Wulapa</i>

* These sites or cultures could more properly be considered covering the period from late Bronze Age to early Iron Age.

Table 56. The cultural framework in Xinjiang proposed by Mei Jianjun (after MJJ 2000, 5 Table 1.3)⁷⁴⁸.

⁷⁴⁶ The northern China proposed by Yang Jianhua is in accordance with the north-central China and south of the Yanshan region in this study.

⁷⁴⁷ YJH 2004, 150-139.

⁷⁴⁸ Mei J. J. supposed that the Bronze Age and Iron Age in Xinjiang is corresponding to ca. 2000-1000 BCE and 1000-300 BCE respectively.

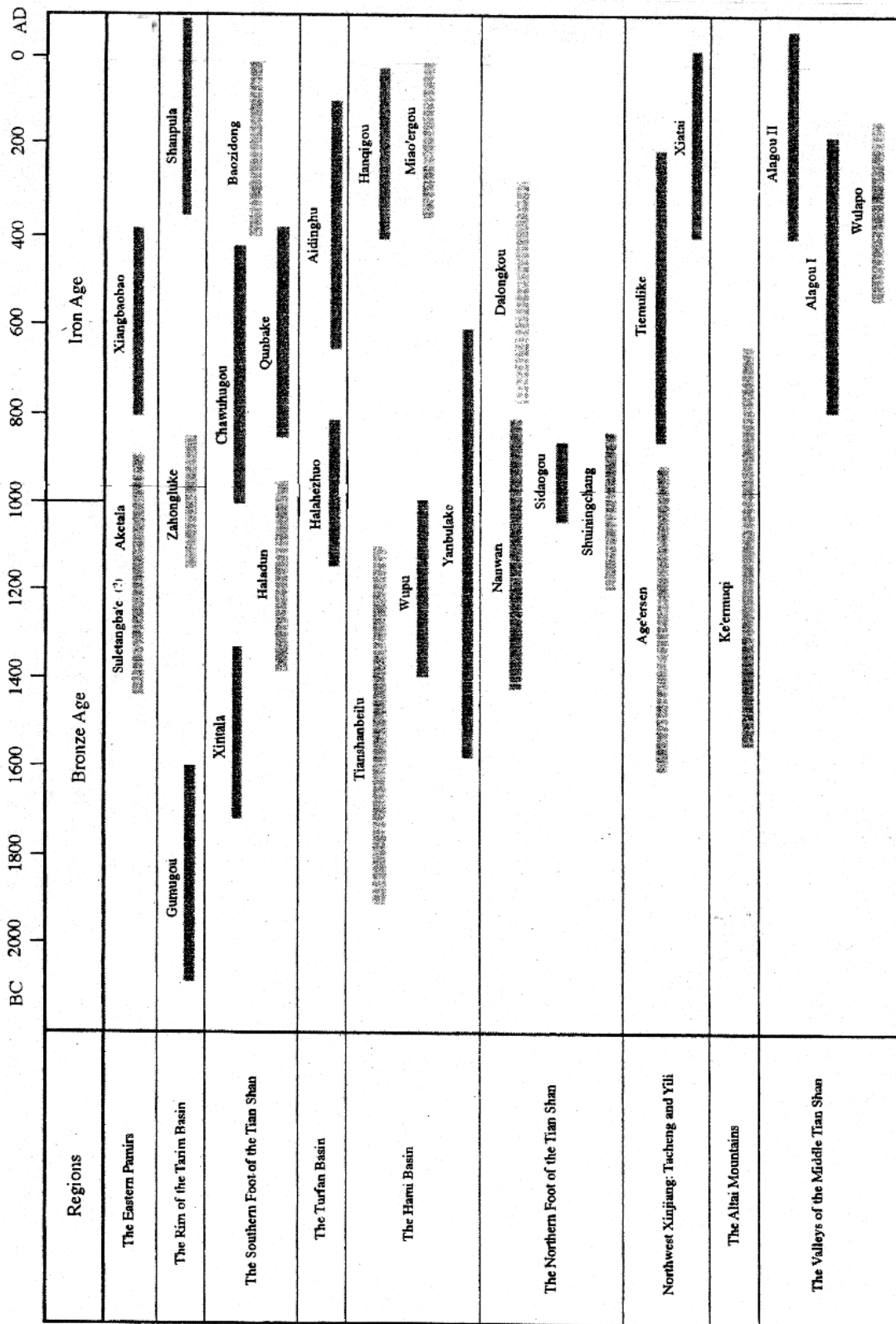


Table 57. The chronological sequence for the Bronze Age and Iron Age cultures in Xinjiang (after MJJ 2000, 85 Table 2.3).

7.2.2 Relations between Xinjiang and northern China

The Northwest Complex shows closer connections to the Xinjiang culture than the North-central Complex and south of the Yanshan Complex. In addition to the affinity between potteries, the bronze objects and metallurgical technology also displays similarities.

For example, the Qijia metalworking characterized by hammering and casting, is comparable to the western tradition. According to Mei Jianjun's opinion, the connections between Xinjiang and Qijia are most likely to have been indirect. So far, the only Bronze Age site that may be related to the Qijia culture is the Tianshanbeilu cemetery in Hami city. This speculation is supported by the resemblance between the knife from Tianshanbeilu, with two projections on its back, (Fig. 139a, A7) and the Qijia knife found in Huangniangniangtai (Fig. 099b, 1). In addition, there may be a relationship between the Qijia mirror (Fig. 099b, 22) and the mirrors found in the Tianshanbeilu burials (Fig. 139a, A5). Although the evidence available so far is extremely scanty, cultural contact between Qijia and the northern Eurasian Steppe through the Tianshanbeilu culture in eastern Xinjiang, and the Siba culture in western Gansu seems quite possible⁷⁴⁹.

In comparison to the Qijia culture, the Siba culture may have closer relations with Xinjiang. Though it is impossible to present a full account of the relationship between Siba and Tianshanbeilu, a few preliminary observations have been made by Mei Jianjun, based on the information available⁷⁵⁰. Firstly, as revealed by the metallographic examination of some Tianshanbeilu samples, the bronze technologies of the Tianshanbeilu culture are comparable to those of the Siba culture in terms of the use of casting, forging, annealing, and cold working. In addition, the typological similarity between objects from both cultures can be observed in the cases of knives, earrings, and mirrors (Fig. 139a, A). Furthermore, as scientific analysis has shown, the major copper alloy used by the Tianshanbeilu people is tin bronze which contains 16% tin on the average, and Cu-Sn-Pb alloy was used in rather small amounts. This analysis recalls the metallurgical results of the Huoshaogou metal objects, indicating that about half of the analyzed metal samples are Cu-Sn and Cu-Sn-Pb alloys.

So far, arsenical bronze, which has rarely been found within the present boundary of China, has been identified among metal objects from the Siba culture. It is well known that arsenical bronze was produced and used extensively in Eurasia and the Near East during the early Bronze Age of the third millennium BCE. Some scholars have already speculated that the presence of arsenical bronze in the Siba metal objects

⁷⁴⁹ MJJ 2000, 62.

⁷⁵⁰ MJJ 2000, 63.

may imply certain cultural exchanges between Siba and earlier cultures to the west. In this regard, two metal objects found at the Wupu cemetery in eastern Xinjiang have been identified as arsenical copper with 3-4% As. According to the radiocarbon dating, the Wupu arsenical copper can tentatively be placed within the period 1400-1100 BCE, and it is later than the Siba culture. Thus, on the basis of all the above considerations, the existence of links between Tianshanbeilu and Siba with respect to bronze technologies seems most likely⁷⁵¹.

In the later period, the Yanbulake culture bearing some distinctive features, suggests connections with many other cultures in the Northwest Complex as well⁷⁵². In contrast to a relatively large number of copper and bronze finds from the Yanbulake culture, the Xindian sites have yielded only a small number of bronzes. However, the metal objects of the Kayue culture, such as mirrors, tubes, buttons, and knives (Fig. 101d) can also be found in Yanbulake (Fig. 139a, B). In Mei Jianjun's opinion, the influence is likely to have come from two directions: whilst the painted pottery of the Kayue or Xindian cultures spread westwards, some bronze forms were transmitted eastwards from Xinjiang into Gansu. Moreover, the first use of iron knives in the later phases of the Kayue culture, may also have been inspired or influenced from eastern Xinjiang, where iron was in use at Yanbulake from the early first millennia BCE⁷⁵³. How iron technology was transmitted eastwards from Xinjiang into Central China during the early first millennia BCE also remains largely within the realm of speculation due to a lack of sufficient evidence⁷⁵⁴.

A few iron objects have been discovered in the Shajing culture, which can be dated to 900-600 BCE. In addition to the affinity in pottery forms and painted designs, some bronze forms, such as tubes, knives, mirrors, and axes, which were very typical in the Shajing culture, were found in the Chawuhugou cemetery as well (Fig. 139b).

As stated by Mei Jianjun, cultural interactions between the Xinjiang and Gansu-Qinghai regions during the first half of the second millennia BCE took place largely between the bronze cultures of Qijia, Siba, and Tianshanbeilu. It seems quite clear that there was a two-way traffic of cultural influence, with painted pottery spreading westwards and bronze technologies being transmitted eastwards, though the overall picture of these interactions is still rather obscure. An innovation centre of bronze technologies may have developed in the Gansu-Qinghai region during this period based upon the rich resource of non-metallic ores in the region. The connections between Yanbulake and Kayue-Xindian indicate that interactions between the

⁷⁵¹ Quoted from MJJ 2000, 63-64.

⁷⁵² The pottery affinity is not mentioned here.

⁷⁵³ MJJ 2000, 65.

⁷⁵⁴ MJJ 2000, 65.

Xinjiang and the Gansu-Qinghai region continued during the latter half and early first millennia BCE. However, the context for these interactions was much more complicated than has been realized in the past⁷⁵⁵.

In general, the prehistoric cultures in Xinjiang bore their own features in potteries and burial practice, which actually indicate more connections with south Siberia, and Central Asia rather than with northern China. Regarding the metal objects, Xinjiang, the Eurasian Steppe, and northern China share some common features especially after the Spring and Autumn period, such as horse fittings, loop headed knives, socketed axes, earrings, animal style plaques, cooking ware-Fu and so on (Fig. 140a; Fig. 140b; Fig. 140e). Mei Jianjun and Yang Jianhua⁷⁵⁶, have already given an overview of the interactions between Xinjiang and the Eurasian Steppe, so the resemblance of the metal objects between Xinjiang, north-central China, and south of the Yanshan region will not be mentioned here. In fact, of the metal objects, only a small quantity of them show a northern bronze style, including some belt hooks, plaques, tubes, beads, and so on (Fig. 140c). Besides, a few straight bladed knives and flower shaped ornaments represent a particular Xinjiang style (Fig. 140d), which were rarely seen in other regions (Fig. 140d).

7.3 Relations with the Eurasian Steppe

North China is located in the southeastern end of the Eurasian Steppe⁷⁵⁷, which is an important area for communication between Chinese and Western cultures. The verification of the relationship between the bronze cultures of northern China and the Eurasian Steppe, will not only help us to understand the cultural origin of the bronze wares in northern China and the Yellow River branches, but also give us a better understanding of the formation and development of these ancient civilizations. The close cultural affinities between the Bronze Age cultures of southern Siberia and those of the northern zone of China have been recognized and pointed out in most of the earlier studies⁷⁵⁸. Chinese scholar, Li Gang, did a comprehensive study on the cultural elements of the Eurasian Steppe in the bronzes of northern China, paying particular attention to the metal objects⁷⁵⁹. By analyzing and comparing the form, decoration, and usage of the same kinds of bronze wares between northern China and the Eurasian Steppe, he reached the conclusion that there were three times the impact from the Bronze Age cultures of the Eurasian Steppe and Western Asia to the north of China. The first impact spurred on the beginning of the Chinese Bronze Age. The

⁷⁵⁵ MJJ 2000, 66.

⁷⁵⁶ MJJ 2000, 58-61, 66-71; YJH 2004, 150-155.

⁷⁵⁷ Eurasian Steppes starts from the Danube River in the west, through the West Europe Plain, west Siberia Plain, Kazakhstan mountain ranges, Mongolia Plateau, to the Songliao Plain of China in the east.

⁷⁵⁸ Pak Y. J. 1996, 406-414; YJH 2004, 142-148; LG 2004.

⁷⁵⁹ LG 2004.

second impact was manifested by the sudden increase of new bronze weapons, which also meant the expanding scale of war. The third impact can be seen from the influence of a nomadic culture on the cultivation. This opinion differs in some aspects with Pak Yangjin⁷⁶⁰ who proposes a three-phase suggestion for the relations between southern Siberia and northern China⁷⁶¹ on the metallurgical development. Based on their research, this study will divide the interaction between the Bronze Age cultures in these two areas into three periods: early, middle, and late.

7.3.1 Early period: 3000-1800 BCE

During this period, the metallurgy of the Eurasian Steppe and northern China was in an incipient stage. In contrast, the western Eurasian Steppe was provided with not only fruitful ore resources but also relatively advanced metallurgy. For example, some copper/bronze axes with a tubular handle, swords, arrowheads, and four-ridged awls have been found in Caucasia, which are made of copper and copper-arsenic alloy. However, in the middle region of the Eurasian Steppe, copper/bronze objects remain unclear. In the eastern Eurasian Steppe, the Afanasiev culture, the earliest copper-working culture of southern Siberia, was primarily confined to the Minusinsk Basin and the Altai region (Map 32). Its metallurgy is remarked by copper needles, awls, and small knives (Fig. 142:1-10)⁷⁶². Nevertheless, the stone and bone objects (Fig. 142:11-18) predominate over copper objects, indicating that the role of copper was still somewhat limited. The types of bronzes are much more diverse in the next period of the Okunevo culture, which was distributed in the Minusinsk Basin at the beginning of the second millennia BCE. It includes knives, awls, shaft-hole axes, adzes, chisels, daggers, spearheads, and needles.

In comparison, the diversification of copper/bronze objects in northern China seems to have occurred much later than in the Eurasian Steppe. Until now, only two metal objects have been identified from 3000 to 2300 BCE. The earliest metal object was discovered in Linjia, Dongxiang, Gansu Province, and northwest China, which has been discussed in chapter 2.3.1. It was a bronze knife (Fig. 043b, 1), attributed to the Majiayao culture⁷⁶³, containing 6-10% tin. The dendrite-like grains aligning on the edge from the metallurgical observation suggest that it was probably made by cast or wrought. The radiocarbon dates of this site suggest a chronology around 3000 BCE. Another broken knife found in Jiangjiaping, Yongdeng county, Gansu Province is dated to 2330-2055 BCE⁷⁶⁴. In addition to several fragments of slag found at the same

⁷⁶⁰ Pak Y. J. 1996, 406-414.

⁷⁶¹ The northern China defined by Pak Yangjin includes the Xinjiang region and northeast China as well, which is bigger in spatial range than this study.

⁷⁶² Chernykh (1992, 86-88) ascribed also the stray find of a bronze axe from the Altai into the metal assemblage of the Afanasiev culture.

⁷⁶³ One late Neolithic culture in the Gansu and Qinghai regions.

⁷⁶⁴ Yan W. M. 1978, 69.

time, the Gansu Province is provided with an abundance of copper ore, including cassiterite and jewellers putty. All of the evidence implies the possibility of local manufacture.

In addition, it was after the Qijia culture (2300-1800BCE) that more copper/bronze objects were found in northwest China. They consisted of small ornaments and implements, including; mirrors, rings, axes, knives, awls, and daggers, and so on (Fig. 099b). They were made of copper and copper-tin alloys. It is worth mentioning that the four-edged awl (Fig. 099b, 11) in the Qijia culture was very common in the western Eurasian Steppe, Caucasia, and West Asia. The mirror with two holes on the back (Fig. 099b, 21) was also seen in the Namazaga V culture (2400-2000 BCE)⁷⁶⁵ which was distributed mainly in southern Turkmenistan.

In short, in the early period, only the Majiayao culture and Qijia culture in the northwest of China yielded some metal objects made of copper and copper-tin alloys. So far, no metal objects have been found in other regions of northern China. The earliest two metal objects in the Majiayao culture show similarities neither in form nor in composition to those in the Eurasian Steppe. However, similar metal objects of the Qijia culture can be found in the Eurasian Steppe. Today, we are still far from drawing a clear picture of the direct contact between the Eurasian Steppe and northern China.

7.3.2 Middle period: 1800-800 BCE

This middle period is characterized by the sudden growth of bronze weapons in the Eurasian Steppe. The rise of the Andronovo culture marked the beginning of an advanced bronze-using time. The Andronovo culture, centered in the Minusinsk Plain, is a Bronze Age complex that comprised a number of regional variants. It covered an extensive area, stretching from the Urals to the Yenisey, and from the northern border of the forest-steppe to the south of the Pamirs in Tadzhikistan (Map 33). Kuzmina dates this culture complex to the period between the 17th and 9th centuries BCE. However, some scholars favor an earlier date of 2000 BCE for the beginning of the Andronovo culture, on the basis of the radiocarbon dates from the Sintashta-Petrovka site in the Ural region. It has been suggested that the Andronovo culture mainly occupied the area between the rivers Ural and Irtysh at first, and extended later as far as the upper Yenisei River to the east, and the desert oasis of western Asia and the Tianshan to the south. In contrast to the Afanasievo culture, a large number of bronze weapons and implements, such as axes, arrowheads, knives, spearheads and awls as well as casting molds, have been found in the Andronovo burials, demonstrating the high level of bronze technology used in the Andronovo culture (Fig. 143, 7-16)⁷⁶⁶. Recent studies further suggest that the horse-drawn chariot may have been used by the Andronovo people, and this innovation, as well as the bronze metallurgy, played a

⁷⁶⁵ Parzinger 2006.

⁷⁶⁶ Jacobson 1993, 16.

crucial role in the expansion of the Andronovo culture during the second millennia BCE⁷⁶⁷.

As stated by Mei Jianjun, the existence of the Andronovo cultural influence in Xinjiang is, indeed, a part of the Andronovo cultural expansion, a widespread cultural process that was taking place in Eurasia during the second millennia BCE. According to Mei Jianjun's opinion, the Bronze Age finds in this region, such as the Aga'ersen hoard (Fig. 143), the Weixiao site, and the Sazi cemetery (Fig. 145a), show a close affiliation with the Andronovo culture. This affiliation suggests the existence of a bronze culture that may tentatively be named Aga'eren. The metal artifacts, such as shaft-hole axes, sickles, flanged adzes, socketed celts, gouges and spades (Fig. 145b) have been identified as typical of late Andronovo culture. The Tacheng metal objects have also revealed a technological link with the Andronovo context. The distribution of the Andronovo-type artifacts identified so far in Xinjiang has revealed that northwestern Xinjiang was a pivotal region for the presence and spread of the Andronovo culture (Map 33). In addition, the Altai region, the most northern part of Xinjiang, might be another important area for establishing contact between Xinjiang and Andronovo⁷⁶⁸. Exactly when the Andronovo culture began to enter northwestern Xinjiang is still being questioned. The Andronovo-related material known so far in Xinjiang is primarily associated with the late Andronovo context and is dated to the latter part of the 2nd millennia BCE. Most of the evidence of the Andronovo influence on Xinjiang is from stray finds. This limits our understanding of the nature of the Andronovo-type culture in Xinjiang. For instance, the Aga'ersen, is characterized by a close affiliation with the Andronovo remains in eastern Kazakhstan, that had a relatively high level of bronze metallurgy. However, we know little or nothing about its settlement or economy. We have no idea whether bronze objects of the Andronovo-type were made locally or brought into Xinjiang by immigrants or traders⁷⁶⁹.

At the same time, the Siba culture (1900-1500 BCE), a relatively developed bronze-using culture, arose in northwest China. It has yielded a large number of metal objects, including arrowheads, knives, axes, awls, bracelets, and earrings (Fig. 104b). According to Li Shuicheng⁷⁷⁰, many Siba copper objects show a stylistic connection with the northern Eurasian Steppe. For example, the copper awls with a bone handle (Fig. 104b, 21) are similar to those of the Okunevo culture in southern Siberia. The socketed axes (Fig. 104b, 9-10) also have their parallels in southern Siberia and Ordos. One copper pole-top decorated with four projecting ram-heads (Fig. 104b, 34) found at the Huoshaogou cemetery is unusual, which Bunker considers comparable to the

⁷⁶⁷ The overview of the Andronovo culture is mainly referred from MJJ 2000, 59.

⁷⁶⁸ MJJ 2000, 59-60.

⁷⁶⁹ MJJ 2000, 61.

⁷⁷⁰ Li S. C. 1993, 105.

Central Asian and ancient Near Eastern designs. Gold and silver rings found at the Huoshaogou cemetery also suggest some connections with distant cultures to the west, though no definite conclusion can be made about specific sources. In the opinion of Fitzgerald-Huber, the larger number of horse bones that have been found in the Siba burials suggest a further link to the steppe⁷⁷¹.

Some scholars have already speculated that the presence of arsenic copper in the Siba culture may imply certain cultural exchanges between Siba and early cultures to the west. In terms of Mei Jianjun's elemental analysis, two samples from the Wupu cemetery in eastern Xinjiang have been identified as arsenical copper with 3-4% of As. According to radiocarbon dating, the Wupu arsenical copper can tentatively be placed within the period 1400-1000 BCE, and is later than the Siba finds. Thus, we have a rather complex picture concerning the Siba culture itself, as well as its technological relationship with eastern Xinjiang. Further research is required on the issue of the earliest appearance of arsenical copper in Xinjiang and Gansu⁷⁷².

In the 13th century BCE, the Andronovo culture in southern Siberia was replaced by an entirely different culture, the Karasuk culture (1300-800 BCE)⁷⁷³, which is characterized by some distinctive bronze forms, such as knives and daggers with handles ending in animal designs (Fig. 145, 1-10). The Karasuk culture is centered in the Minusinsk Basin on the middle of Yenisei, with extensions southwards into Mongolia and the Altai area. The similarity of the style and type of bronze artifacts, between the contemporary bronze cultures in the North-central Complex, south of the Yanshan Complex and Karasuk culture is striking. Bronze knives and daggers with a ring, mushroom-shaped or animal-head pommel, socketed axes, shaft-hole battle axes, shaft-hole halberds-Gi, socketed spearheads, bow-shaped ornaments, and other bronze weapons and tools, have been found in the Minusinsk Plain, and display close stylistic similarity to the so-called 'Northern-style' bronzes that have been found in northern China, dated to the late Shang and early Western Zhou period. Such kinds of bronzes were particularly found in the late Shang tombs of Anyang. The focus of the earlier debate was on whether these bronzes originated with the Shang in the Central Plain or in southern Siberia. The growing recognition amongst scholars of the existence of an independent cultural complex in the 'Northern Zone' region in China (the northern borderland of the Shang and Zhou China), indicates that the Northern Zone complex played a key role not only in bridging the relationship between the Karasuk and Shang cultures, but also in creating and spreading new bronze forms and decorative patterns throughout the eastern Eurasian Steppe⁷⁷⁴. In addition, as mentioned in chapter 4 and

⁷⁷¹ MJJ 2000, 63.

⁷⁷² MJJ 2000, 64.

⁷⁷³ Chernykh 1992, 268.

⁷⁷⁴ Lin Y. 1986, 268-271; translated by MJJ 2000, 66.

chapter 5, the bronze objects in the North-central Complex and south of the Yanshan Complex were mainly made of Cu-Sn alloys and Cu-Sn-Pb alloys.

Conclusively, during the middle period, the metallurgical development of the Eurasian Steppe may have pushed the growth of metallurgy in northern China, which is reflected in the similar bronze weapons and implements found from the Eurasian Steppe and northern China. However, there is still a lack of sufficient and direct evidence to prove the origin of the so-called 'Northern-style' metal objects.

7.3.3 Late Period: 800-200 BCE

The late period is roughly equal from the Spring and Autumn period to the end of the late Warring States period in the Central Plain, and is contemporary with the decline of the Karasuk culture as well. It is quite remarkable that northern China and the Eurasian Steppe shared more common features after the Spring and Autumn period.

The Eurasian cultures during this time include: the Scythian on the north shore of the Black Sea, the Tagar culture in the Minusinsk Basin of southern Siberia, the Saka culture of Central Asia, the Pazyryk culture of the Altai and Tuva regions, and the stone-slab tomb culture of Trans-Baikal etc.. The Nuomuhong culture, the late period of the Kayue and Xindian cultures, the middle and late Shajing culture, the Yanglang culture, the Taohongbala culture, the Maoqinggou culture, and the Yuhuangmiao culture were distributed in northern China from west to east. There are great similarities between these cultures. The metal objects consisting of weapons, tools, horse and chariot gears (bits), and ornaments (plaques in an animal style and mirrors), cooking ware-Fu (Fig. 141a; Fig. 141b; Fig. 140e), suggest that the horse-riding military of northern China and the Eurasian Steppe were similar to the development of a nomadic lifestyle.

Conclusively, during the early period, the Qijia culture shows a resemblance in its bronze objects to those found from the Namazga V culture, the Caucasia region, and Pit-grave culture, though no credible evidence is provided for their direct contacts. In the middle period, the influence from the Andronovo culture, Karasuk culture, and Deer Stone culture can be observed in the Xinjiang region, Siba culture, and other northern cultures in China.

7.4 Origin of the Chinese bronzes

The emergence of the production of metal objects is a milestone event in human activity. It marks fundamental changes in the social development and working relationships among people. Therefore, research on the origin and development of metallurgy, and on the transition from the Neolithic to the Bronze Age is one of the

most important topics in archaeological studies. The Shang and Zhou dynasties were the peak periods of the Chinese Bronze Age culture. The general use of metal objects, along with the formation of the state, the appearance of sites, and a writing system, are considered basic elements of civilization in world prehistory⁷⁷⁵.

Articles about the beginning stages of metallurgy in early China, about regional cultures where this can be documented, and about the materials and manufacture of the earliest datable metal artifacts excavated in the last half part of the 19th century have been brought together in *The Beginning of Metallurgy in China* edited in English by K. M. Linduff, Han Rubin, and Sun Shuyun⁷⁷⁶. In addition, *Metallurgy in Ancient Eastern Eurasia from the Urals to the Yellow River*, also edited by K.M. Linduff⁷⁷⁷, is a fabulous contribution to the scholarly literature concerning the emergence and spread of metal technology in the Eurasian Steppe during the third and second millennia BCE. Besides their technological significance, resolutions to questions of when and how metal technology spread, illustrate our understanding of social developments throughout this vast region⁷⁷⁸. Therefore, the debate about the beginnings and uses of metallurgy in antiquity worldwide, especially in China is possible.

Over the past fifty years, many scholars have drawn great attention to the origins and early evolution of copper and bronze metallurgy in China. 'It was generally assumed among western scholars until recent decades that metallurgy was introduced into China from the outside because primitive stages have, in fact, been discovered nowhere in China up to the present moment.'⁷⁷⁹ Archeological finds in China since 1949, however, have shown clearly that there existed a primitive stage of metallurgy before the emergence of a mature bronze metallurgy in the Shang Dynasty. This led a number of scholars, notably N. Barnard⁷⁸⁰, Cheng Te-K'un⁷⁸¹, Ho Ping-ti⁷⁸², Sun Shunyun and Han Runbin⁷⁸³, Ke Jun⁷⁸⁴ and Hua Jueming⁷⁸⁵, to argue strongly that metallurgy in early China was of an indigenous origin. Some other scholars, however, still considers that 'so far metal use in north China has not differed much from that of the Turkmenian cultures' and hints at the existence of possible contact between China and Central Asia since the third millennia BCE' or 'it can no longer be maintained that metallurgy began in China in ways radically different from those known elsewhere'.

⁷⁷⁵ An Z. M. 2000, 29.

⁷⁷⁶ Linduff et al. 2000.

⁷⁷⁷ Linduff 2004.

⁷⁷⁸ E. C. Bunker, in: Linduff 2004, i.

⁷⁷⁹ Loehr 1949, 129.

⁷⁸⁰ Barnard 1983, 237-277.

⁷⁸¹ Cheng 1974, 209-229

⁷⁸² Ho 1975, 177-221.

⁷⁸³ Sun/Han 1981, 287-301.

⁷⁸⁴ Ke J. 1987, 225-243.

⁷⁸⁵ Hua J. M. 1991, 364-369.

In a review of all the known evidence for early copper artifacts in China, An Zhimin⁷⁸⁶, a leading Chinese archaeologist, is also inclined to claim the introduction of metallurgy to China from the west. He remarks ‘the appearance of early copper artifacts in China was relatively late; at least there were still no copper objects produced during the Neolithic five or six thousand years ago... Early copper artifacts quite possibly originated from or came into China through the prehistoric ‘Silk Road’. There is a long way to go before any consensus can finally be reached about the beginning of metallurgy in China’. Keightley⁷⁸⁷ points out that the origins of Chinese civilizations will not be fully understood until the Neolithic and Bronze Age context of the Eurasian steppe as a whole is clarified⁷⁸⁸.

7.4.1 The earliest copper/bronze objects in China

Up until now, more than 1700 early copper/bronze objects⁷⁸⁹ dating from 3000-1500 BCE, including ornaments, tools, weapons, ritual vessels and musical instruments, as well as containers have been found from more than 70 places (Map 34). Among them, small ornaments and tools were in large quantities and the places where they were found cover a vast range of area. By contrast, weapons, ritual vessels, musical instruments and containers were in smaller quantities, and located in a limited area. To be specific, the ritual vessels and musical instruments, as well as containers were only found in the Central Plain. Moreover, their shapes are usually quite simple and rarely adorned with designs. As for the chemical composition, these objects were made more of copper than bronze. Sometimes there is a small quantity of arsenic-copper alloy and brass found in the earlier period. Casting and hammering were used simultaneously in making bronzes (Table 58). From these metal objects prior to 1500 BCE, we can see that the cultures where copper as well as alloyed metals were first used and manufactured are located across a large area from the west, across the northern frontier, to the eastern seaboard and to the north of what has been traditionally called China copper. The growth of the industry did not solely, or even primarily, occur in the Central Plain associated with early dynastic China, but in several regions (Map 34). Moreover, preliminary observation on the process by which the places where the technology developed as well as the role of metals and metal objects in these societies suggests that whereas each locus was quite distinct culturally even during the early dynastic period, they were probably interconnected⁷⁹⁰.

From Map 34, we can see that these sites were clustered in four broad geographical

⁷⁸⁶ An Z. M. 1993, 1117.

⁷⁸⁷ Keightley 1983, xxiv.

⁷⁸⁸ This review on the previous opinions on the origin of the Chinese metallurgy is referred from MEI J. J. 2004, 173-174.

⁷⁸⁹ About 1500 metal objects were found in the Gansu, Qinghai and eastern Xinjiang regions. About 200 pieces were centered to the west of the Henan Province.

⁷⁹⁰ Linduff et al. 2000, 10.

regions, corresponding to their known archaeological cultures.

1. The Central Plain concentrated on the Shanxi, Shaanxi, and Henan provinces of modern China where the Yangshao, Taosi, and Erlitou cultures were distributed. It is noticeable that since the Erlitou culture (1900-1500 BCE) especially the latest two levels (Strata 3 and 4, c. 1700-1530 BCE) that the well-known evidence regarding the ritual use of bronzes can be documented. The metal objects include cast vessels, Jue vessels, chisels, arrowheads, knives, adzes, and other small ornaments. On average the alloys contain 5.55% tin and 1.2% lead. Bronze knives, plaques, and disks are inlaid with stones including turquoise. The use of bronzes in some graves, therefore, is clearly tied to the display of status, and is restricted to use only in the most elaborate graves. At these levels in the site of Erlitou itself, metal tools were scarce and the bronze industry was clearly prescriptive and probably controlled by the political and/or social elite⁷⁹¹.

2. In Eastern China centered in the Shandong Province, most of the early metal objects are ascribed to the Longshan and Yueshi cultures respectively, and both of them are dated from 2500-1900 BCE. The metallurgy was limited to the production of simple artifacts such as personal ornaments and tools. In addition, they were found primarily in habitation, and occasionally in burials. So far, the excavated materials do not indicate either in number or technological sophistication the existence of a metal/bronze industry, but rather it is treated as an experimental craft, probably managed at an individual household level⁷⁹².

3. Northeastern China includes eastern Inner Mongolia, northern Hebei, and western Liaoning. The earliest metal artifacts should be ascribed to the Hongshan culture, which is dated to 3000 BCE. Some copper-rich malachites were found in the Niheliang region too. The Lower Xiajiadian culture, dating from 1900-1500 BCE in this region produced many metal items such as, tools-copper objects such as awls, chisels, pins, and personal ornaments including small rings with trumpet-shaped terminals, bracelets, rings and pendants. Most of them were copper, and some of them were bronze with up to 10% tin. In addition, several stone and ceramic molds for axes were found. According to the burial customs and settlements, the inhabitants of both eastern China and northeastern China were aware of metal technology in its most primitive form and must have been able to exploit nearby resources of ores, which required limited refining. These regions probably had their own technology, and were not influenced by other regions⁷⁹³.

⁷⁹¹ Linduff et al. 2000. 11.

⁷⁹² Linduff et al. 2000, 11.

⁷⁹³ Linduff et al. 2000, 11-13.

4. Located in the northwest of present-day China, in the Gansu, Qinghai and Xinjiang Provinces, the early metal objects found in these areas are quite striking. Several metal objects belonging to the Majiayao culture (3000-2000 BCE) were found in habitation debris. In the subsequent period (2000-1600 BCE), a sharp increase of metal objects were identified as belonging to the Qijia and Siba cultures. The information on these metal objects have been mentioned and discussed in Chapter 3 and Chapter 7.3. Therefore, we can see that the metal objects of the Qijia culture are almost pure copper and bronze. Metallographic analyses of some metal objects show that the people in this region were reducing local copper-zinc ores from as early as about 3000 BCE⁷⁹⁴, but that the alloying of metals was limited until about 2000 BCE. As for the Siba culture (1900-1600 BCE), the metal objects from the Ganguya, Donghuishan, and Huoshaogou sites were of Cu-Sn alloys, Cu-As alloys and Cu-As-Sn alloys. Multi-mold casting was in use. The fabrication of arsenical copper from ores containing copper and arsenic in certain sites as well as manufacturing techniques including both casting and forging were typical of this region and set it apart from the metal using cultures of the Central Plain. In addition, the cast objects made from controlled alloys of copper and tin as well as lead do not indicate an experimental stage in metal production, but are artifacts executed by knowledgeable craftworkers who were called upon to produce both ornamental and utilitarian items. The uses and metallic content of these artifacts were clearly regularized as was their typology and function⁷⁹⁵. As far as the Xinjiang region is concerned, Mei Jianjun has reviewed the information available, which has also been mentioned in Chapter 7.2. The earliest metal objects in Xinjiang are dated from 1800-400 BCE, becoming widespread circa 1000 BCE. The evidence from the earliest period is scant, however it still implies the practice of metal experimentation at that time.

The early metallurgy in China can be determined by four points as proposed by Mei Jianjun⁷⁹⁶: '(1) there is no conclusive evidence for the appearance of metals in China before 3000 BCE, with the controversy over the earliest evidence of brass alloy during the Yangshao period (4400-2500 BCE) still unsettled; (2) there existed an initial phase of bronze metallurgy in the pre-Shang period (before 1600 BCE), the typological features of bronze assemblage from the Erlitou culture (1900-1600 BCE) reveal the origin and early evolution of the Shang bronze metallurgy; (3) it is now firmly established that copper or its alloys came into use in China during the Longshan period (2600-2000 BCE) on the basis of copper finds and copper slag from Henan, Shandong and Inner Mongolia; (4) the Central Plain areas of northern China and eastern Gansu and Qinghai to the northwest, are two major areas where remains

⁷⁹⁴ Linduff et al. 2000, 16.

⁷⁹⁵ Linduff et al. 2000, 17.

⁷⁹⁶ Mei J. J. 2004, 174.

of early metallurgy (prior to the Shang period) have been found⁷⁹⁷.

⁷⁹⁷ An Z. M. 1993, 1119; Sun/Han 1981, 287-301; Linduff et al. 2000, 1-25.

Northwest China				Central Plain and other regions		
4500-2500 BCE	Site/Location	Amount (analyzed)/Composition	Date/culture	Site/Location	Amount (analyzed)/Composition	Date/culture reference
				Jiangzhai, Shaanxi Province ⁷⁹⁸ (Central Plain)	2 brass (65% Cu, 25% Zn, 6% Pb; 69% Cu, 32% Zn)	Banpo type of Yangshao culture
				Weinan, Shaanxi Province ⁷⁹⁹ (Central Plain)	1 brass (?)	Yangshao culture
	Linjia, Dongxiang, Gansu ⁸⁰⁰	1 knife (Cu-Sn)	2900-2740 BCE/Majiyao type of Majiyao culture	Xitai, Aohan, Inner Mongolia ⁸⁰¹ (northeast China)	Some pottery molds	Hongshan culture
	Liangcheng, Yongdeng, Gansu ⁸⁰³	1 knife	2680-2335 BCE/Machang type of Majiyao culture	Niuheliang, Liaoning Province ⁸⁰² (Northeast China)	1 copper loop	Hongshan culture
	1)Jiangjiaping, Yongdeng; 2) Zhaobitan, Jiuquan; ⁸⁰⁴	1 Cu-Sn; 2 Cu	Machang type of Majiyao culture	Xiangfen, Shanxi Province ⁸⁰⁵ (Central Plain)	1 bell (97.8% Cu, 1.5% Pb, 0.1 Zn)	Taosi type

⁷⁹⁸ Jiangzhai 88.

⁷⁹⁹ BJGY 1981, 287-302.

⁸⁰⁰ GSG et al. 1984, 111-116.

⁸⁰¹ KGB 1989, 1110-1120.

⁸⁰² Guo D. S. 1994, 281.

⁸⁰³ An Z. M. 1981, 269-285.

⁸⁰⁴ Sun/Han 1997, 75-84.

	Qinghai and Gansu Province ⁸⁰⁶	22 Cu; 2 Cu-Sn	Qijia culture	Sanlihe, Jiaoxian, Shandong Province ⁸⁰⁷ (east China)	2 awls, Brass (20.2-26.4% Zn)	Longshan culture ⁸⁰⁸
2000-1600 BCE	Dongshui, Minle county, Gansu ⁸⁰⁹	12 As-Cu; 2 Cu-As-Sn; 1 Sn-As-Pb-Cu	Siba culture	Zhukaigou site III-V, Inner Mongolia ⁸¹⁰ (north China)	5 Cu 10 Cu-Sn; 17Cu-Sn-Pb ⁸¹¹ ;	Zhukaigou culture
	Ganguya, Jiuquan, Gansu ⁸¹³	10 Cu-As; 22 Cu-Sn; 5 Cu-Sn-As		Erlitou, Henan ⁸¹² (Central China)	25 Cu-Sn	Erlitou culture
	Huoshagou, Yumen, Gansu ⁸¹⁶	50% copper; 50% Cu-Sn; 13 objects contain As		Dongxiafeng, Shanxi Province ⁸¹⁴ (Central Plain)	28: Cu, Cu-Sn, Cu-Sn-Pb	Dongxiafeng culture
				Yinjiacheng, Sishui, Shandong Province ⁸¹⁵ (east China)	6 Cu-Sn; 3 Cu	Yueshi culture (?)

Table 58. The earliest copper and bronze objects found in China⁸¹⁷.

⁸⁰⁵ ZSKKS 1984, 1067-1071.

⁸⁰⁶ Sun/Han 1997, 75-84; 24 of 45 metal objects have been analyzed.

⁸⁰⁷ CHW et al. 1977, 266.

⁸⁰⁸ Some ingots were found in the Henan Province, ascribed to the Longshan culture.

⁸⁰⁹ Donghuishan 98, 191-195.

⁸¹⁰ Li X. H. et al. 1996, 84-93.

⁸¹¹ Of the 44 metal objects found at the Zhukaigou site, 33 objects have been analyzed. Some are determined to contain certain Arsenic.

⁸¹² Bai Y. X. 2002, 25-37.

⁸¹³ Li/Shui 2000, 36; Sun/Han 1997, 75-84. 46 of 48 metal objects have been analyzed.

⁸¹⁴ DXF 1980, 97-107.

⁸¹⁵ Bai Y. X. 2002, 25-37.

⁸¹⁶ Sun/Han 1997, 75-84. Over 200 metal objects were discovered at the Huoshagou site. Of them, 65 have been analyzed.

⁸¹⁷ The more detailed information can see in Linduff et al. 2000, 322-353 Table I: *Discoveries of and Research on Early Bronzes in China*.

7.4.2 The copper-arsenic alloy in northern China and lead-containing ore resources

All of the areas where metallurgy emerged were near metal ore resources. The distribution of these ore sites has been well summarized in *The Beginnings of Metallurgy in China*⁸¹⁸ (Map 35-Map 36). Each area developed a taste for items made from copper and copper alloys, and gold items have been found in the northeast and northwest of China. Trumpet-shaped earrings, for instance, have been found all over eastern Asia and northern China and were made from copper and tin-bronze as well as gold and silver according to the local preference. The lack of consistency in formulae suggests that the knowledge was gained from several sources and not through local invention⁸¹⁹.

Deposits of non-ferrous metals in Gansu are very common; at present, there are over two hundred sites with mixed deposits of different non-ferrous metal ores. China's tin deposits occur primarily in the south and in the Hebei and Liaoning; but Gansu, Inner Mongolia, and Xinjiang also have some tin (Map 35, Map 36). Accordingly, the early appearance of bronze in Gansu is quite probable in terms of the required resources. Copper ore is sometimes found together with lead and zinc ore, and occasionally it may even contain a little tin ore. The oxide ores of lead and tin are easily reduced by charcoal and thus can be smelted along with copper to form an alloy, thereby resulting in bronze. As we know, eastern Xinjiang, northern Gansu, and south-central of Inner Mongolia are provided with some early arsenical alloys. Most of the arsenical bronzes contain 1%-6% arsenic, and those found from the Gansu region normally exceed 4% arsenic. Therefore, the people may have intentionally learned the arsenic alloying techniques.

It is well known that the arsenic alloys appeared in Caucasus and Western Asia from the late fifth millennia BCE. After the early second millennia BCE, the arsenic alloy was very popular and seen around the eastern Eurasian Steppe; however, brass was widely used in the Carpathian region. Meanwhile, the arsenical bronzes increased in Central Asia. It is from the middle of the second millennia BCE that tin bronze became very common in the Eurasian Steppe. The use of copper-arsenic alloy in the Siba culture of northwest China was roughly parallel to that in the eastern Eurasian Steppe.

Considering the close contact between the Xinjiang and western cultures such as Andronovo, Karasuk and so forth, many scholars believe that the Xinjiang region may very well have been the entry point for bringing metallurgy knowledge into the Gansu Corridor. However, as mentioned in section 7.2.2, up until now, the appearance of the

⁸¹⁸ Linduff et al. 2000.

⁸¹⁹ Linduff 2004, 8.

early metal objects in Xinjiang seems later than that in the Gansu and Qinghai regions. Moreover, two metal objects found in the Wupu cemetery identified as containing arsenic are dated to 1400-1000 BCE, which is later than the arsenical copper in the Siba culture. Therefore, the hypothesis of a western origin of the metallurgy for the Gansu and Qinghai regions are still lacking direct evidence.

There is no question that by the early dynastic period in China, or no later than the Shang Dynasty (ca. 1550-1050 BCE), the ancient Chinese had already considered technological options and made technological choices about metals⁸²⁰. Analysis of these early metal objects, including the metallurgical content of many items and casting technology used, as well as the types and uses of metal artifacts in the period from about 3000 to 1500 BCE has led to some surprising observations about the advent of metallurgy in China, and about its role and development in a complex society. Recent syntheses, which investigate early China usually, view the archaeological landscape during the fourth millennia BCE as a mosaic of regional groups, which interacted with each other⁸²¹.

*Metallurgy in Ancient Eastern Eurasia from the Urals to the Yellow River*⁸²², as mentioned above, is a fabulous contribution to the scholarly literature concerning the emergence and spread of metal technology in the Eurasian Steppe, during the third and second millennia BCE. According to this book, we can see that that many-shared traits in the Eurasian Steppe and China suggest that there was a ‘metallurgical network’ of some type, however loosely connected⁸²³. The approximate chronological and cultural time span between the Eurasian Steppe and northern China, which has been discussed in the preceding chapters, implies that the emergence of metallurgy was quite a regional feature.

⁸²⁰ Barnard 1961.

⁸²¹ Chang 1986, 234-294.

⁸²² Linduff 2004

⁸²³ Linduff 2004, 10.

Chapter 8 Conclusions

The research described in the preceding chapters has thrown new light on the chronological and cultural framework of bronzes in northern China during the 4th and 3rd millennia B. P. and its inner connections and external interactions with the neighboring regions. The major arguments and their broader implications for understanding the early cultural interactions in the whole Eurasian Steppe have been presented. In this chapter, I shall draw attention to those questions that were put forward in Chapter 1, which may be of importance for future research.

Where, when and what kind of metals were used in northern China? What was the origin of the bronzes in northern China?

In fact, the first and fifth question has been partly answered in Chapter 7.4. Northern China in this study is divided into three sub-regions: northwest, north-central, and south of the Yanshan. Sparse evidence of metal use appeared in the late Neolithic Majiayao culture, in the northwest, during the third millennium BCE. Later, in the Qijia culture (2300-1800 BCE), unalloyed copper was used to produce most items, including small implements and ornaments. In the subsequent Siba culture, quite a number of Cu-As alloys as well as Cu-Sn and Cu-Sn-Pb alloys were used. In addition, Cu-Sn alloys were very common in the Kayue and Xindian cultures.

By contrast, little information on the metal used in north-central and south of the Yanshan region before the second millennium BCE is available. The Zhukaigou culture (1900-1200 BCE), the incipient bronze-using culture in north-central, was dominated by Cu-Sn-Pb alloys and Cu-Sn alloys. In addition, two metals of the Zhukaigou culture have been identified as containing As. Sample 5028:3 Ge (2686) contains 5.4% Sn and 6.8% As; Sample H5003:11 arrowhead (2684) contains 15.7% Sn and 1.4% As. They were probably produced from a CuSnAs oxidized ore, though neither the smelting site nor the mine have been located⁸²⁴. As and Sn are similar in that both can be dissolved into Cu to form an α solid solution to make the objects harder. As usually co-exists with oxide ores containing copper, silver, Sn, Cu and Ag. If this oxide ore is smelted in a reducing atmosphere, and the temperature is high (1100°C), As will still not volatilize⁸²⁵. As R. F. Tylecote remarked⁸²⁶, smelting oxidized ores containing As will result in As in cast

⁸²⁴ Li/Han 1996, 84-93.

⁸²⁵ Li/Han 1996, 84-73.

⁸²⁶ Linduff et al. 2000, 265.

artifacts. In general, the amount of As remaining in a bronze alloy is lower than 7%. In smelting oxidized ores that contain less than 1-2% As, the retrieval rate of As is almost 100%. In addition, as mentioned in the previous chapters, the metal objects of the Zhukaigou culture show both influence from the northwest and the Central Plain. Located east of the Zhukaigou culture, the Datuotou culture was a contemporary bronze-using culture. Its metallurgy was probably influenced by the Qijia and Siba cultures in northwest China, which is fully reflected in the trumpet-shaped earrings and arrowheads (Fig. 111c).

From the early first millennia BCE or slightly earlier, iron appeared in bronze-using cultures in northern China. Nevertheless, copper and bronze were still widely used and applied extensively in the manufacture of a vast range of objects. It is worth noting that six samples of the 35 analyzed metal objects of the Taohongbala culture are brass, others are made of Cu-Sn and Cu-Sn-Pb alloys. As we know, the earliest metallurgy of the Central Plain is recognized by brass. Therefore, it is possible that the brass technology in north-central may well be related to the Central Plain. By contrast, neither copper nor arsenic and zinc alloy were determined in the Yuhuangmiao culture, which was roughly parallel to the Taohongbala culture. The tri-element alloys with tin as the leading element were popular in the Yuhuangmiao culture, however, the alloys with lead as the main element were only found in two cases. Moreover, the gold and silver items in an animal style were very common in northern China after the Spring and Autumn period. The Taohongbala culture is in particular characterized by rich gold and silver objects.

According to the aforementioned information, it seems that each sub-region of northern China had its own metallurgical process. The metallurgy of northwest China started from copper, arsenical alloy, then to tin alloys, similar with that of western Central Asia and the Eurasian Steppe during the third and second millennia BCE. Though I am inclined towards the view, that there were some technological links between the northwest (Gansu and Qinghai regions), Xinjiang and Central Asia and the Eurasian Steppe, and that the arsenical alloys in Xinjiang appeared later than in the Qinghai and Gansu regions cannot lead us to believe that the western metallurgical techniques were introduced from west through Xinjiang to the Qinghai-Gansu regions. It was probably caused by the sporadic nature of the archaeological discoveries and excavation. Nevertheless, more evidence is hoped from future fieldwork.

The use of metals in north-central and south of the Yanshan region seemed to begin with copper and tin alloys, differing to the northwest. However, the earliest metal objects in

these two regions display a resemblance with the northwest in forms. Considering the availability of copper and tin alloys in north-central China and south of the Yanshan region (Map 34- Map 36), the possibility of local metal production in this region cannot be ruled out.

Ancient metallurgy in the Central Plain was dominated by the production of small tools and weapons from the late Longshan culture to the early Erlitou period, while ornaments were rare. The alloying technology was developed from copper and brass to tin bronze. Clay molds came into use in the Erlitou II period, which laid the foundations for ritual bronze casting and a flourishing bronze-producing technology in the Yellow River valley in later times. In short, the differences between metallurgy in the northwest region, north-central and south of the Yanshan region, and the Central Plain had a certain relationship to their metal resources, economic patterns and cultural traditions as well as east-west exchanges.

What was the cultural context like for northern China during the 4th and 3rd millennia B.P.? What kind of internal cultural connections existed in northern China?

The answer of the second and third question can be found between Chapter 3 and Chapter 6, which is also the main body of this study (see Fig. 136, Map 24). The Qijia, Siba, Kayue, Xindian, Siwa, Nuomuhong, Tangwang-style pottery, and Shajing cultures in the Northwest Complex passed over some distinctive local features, especially in burial patterns, bronze artifacts, and subsistence. From the archaeological and metallurgical evidence available so far, northwest China took the lead in entering the Bronze Age, however developed much more slowly than the other complexes in the later period. Bronze artifacts were usually composed of small-scale tools, weapons, and ornaments, including knives, awls, arrowheads, joined beads, plaques, bulbs and so on. Only several big bronze artifacts were found in the late Siwa culture, such as bronze Ge (Fig. 103b, 35.38), which may have been imported from the Central Plain. The Xigang and Chaiwanggang sites of the Shajing culture produced many northern-style bronze ornaments. One of the most striking features of the Northwest Complex is that the advanced pottery industry never disappeared, namely, the copper/bronze artifacts had not taken the place of the role of potteries. The subsistence of this complex was a mixture of farming, animal husbandry and hunting. Meanwhile, the proportion of subsistence was in a situation of dynamic variation and differed in each region over time. Farming played a big role from the beginning to the end. It was after the late Qijia culture that animal husbandry increased gradually. In addition, pastoral subsistence does not seem to have

taken the lead in the Northwest Complex because evidence of horse-raising and horse-riding is scarce. The rarity of horse sacrifices and horse fittings found in the bronze-using cultures of the Northwest Complex bear testament to this hypothesis.

The North-central Complex designates the Zhukaigou, Xicha, Lijiaya, Yanglang, Maoqinggou, and Taohongbala cultures located in south central Inner Mongolia and adjacent areas, including northern Shaanxi, northwestern Shanxi, the Qingyang region in Gansu, and Ningxia. It is also the center of the so-called ‘Ordos bronzes’ and ‘Northern bronzes’. There are two discontinuities in cultural development, respectively from the early and late Shang period (1300-1200 BCE) and from the middle Western Zhou period to the early Spring and Autumn period (about 900-700 BCE). The scarce cultural remains from these two periods may be due to infrequent human activity caused by disastrous events at that time. The flourishing Yanglang, Taohongbala, and Maoqinggou cultures were distributed side by side from the early Spring and Autumn period to the late Warring States period. On one hand, they show some common characteristics, such as animal sacrifice, splendid metal objects with a strong pastoral style, and so on. On the other hand, they distinguish themselves by their burial patterns, bronze assemblages, and subsistence⁸²⁷.

The individuality of the south of the Yanshan Complex has been recognized gradually by scholars. It defines the bronze-using cultures distributed within the northern Hebei region and the Beijing and Tianjin regions, including the Datuotou, Weifang III, Upper Zhangjiayuan, and Yuhuangmiao cultures. Compared to the North-central Complex, the bronze cultures in the south of the Yanshan Complex are more continuous, which is recognized by a mixture assemblage of both northern-style bronzes and central China style bronzes. From the late Neolithic to the late Western Zhou period, the Datuotou, Weifang III, and Upper Zhangjiayuan cultures developed successively. There is also a cultural discontinuity during the late Western Zhou period to the early Spring and Autumn period, almost parallel to the second break taking place in the North-central Complex. After the Spring and Autumn period, the Yuhuangmiao culture emerged with splendid metal objects. The Yanglang, Taohongbala, Maoqinggou, and Yuhuangmiao cultures seem to have flourished simultaneously from west to east in northern China. ‘Northern bronzes’ entered a prosperous era.

In general, the copper/bronze metallurgy of these two complexes appears later than that of the Northwest Complex. The earliest metal objects were possibly influenced by or

⁸²⁷ The slight difference in subsistence has been discussed in Chapter 6.

imported from the northwest. In comparison, the metallurgy industry developed very fast in the later period and reached its climax after the Spring and Autumn period. At the same time, animal husbandry played a leading role for the north-central and south of the Yanshan people; however, the crucial function of farming cannot be ruled out because the Maoqinggou and Yuhuangmiao cultures were still dependent on semi-pastoral and semi-agriculture subsistence according to the available archaeological evidence.

Of course, the interactions between these three complexes are beyond question. According to the archaeological evidence available, the affinities between the North-central Complex and south of the Yanshan Complex were much closer than the relations between the Northwest Complex and its eastern complexes were. From the second millennia BCE to the middle Shang period, the Northwest Complex had more influence on the other two complexes. The Qijia and Siba culture spread through the Hexi Corridor and Yinshan to the Zhukaigou and Datuotou cultures, which is especially evident in bronze objects. The communications were two-way. From the middle Shang period to the late Warring States period, the impact from the Northwest Complex reduced when the influence of the North-central Complex and south of the Yanshan Complex increased. With the development of the pastoral subsistence, the entire northern China shared more common cultural features after the Spring and Autumn period.

What kind of external cultural connections and technological interactions existed between northern China and its neighboring regions during the 4th and 3rd millennia B. P?

The fourth question has already been answered in Chapter 7. The Northwest Complex were seemingly more connected with cultures to their own west, and remained outside of the Chinese cultural and political dynastic area until the Qin conquered these lands around the fifth century BCE. By contrast, south of the Yanshan region seems to be Central Plainized. Each region might have optionally adapted or borrowed different traits of the Central Plain culture. The widespread central-style Ge-daggers found in northern China suggests that the interactions between northern China and the Central Plain were mainly through warfare. The orientation of the Great Wall is roughly in accordance with the scale of the influence from the Central Plain. Consequently, cultures located to the south side of the Great Wall became progressively part of the Central Plain culture; while those in the north attached themselves further into the Eurasian Steppe cultures.

Cultural interactions between the Xinjiang and Gansu-Qinghai regions during the first half of the second millennia BCE largely took place between the bronze cultures of Qijia,

Siba, and Tianshanbeilu. A metallurgical center may have developed in the Gansu-Qinghai region during this period based upon the rich resources of non-metallic ores in the region. From the Spring and Autumn period onwards, the Xinjiang, Eurasian Steppe, and northern China shared some common features that were related to pastoral life, such as horse fittings, loop headed knives, socketed axes, earrings, animal style plaques, cooking ware-Fu and so forth (Fig. 140a; Fig. 140b; Fig. 140e).

In addition to the possible technological links between the Eurasian Steppe and northwest China, evidence of cultural connections between northern China and the Eurasian Steppe cultures are fully reflected in the pastoral metal objects with animal patterns. The cultural elements of the Pit-grave culture, Andronovo culture, Karasuk culture, and Deer Stone culture can be traced to Xinjiang and northern China. It is crucial to realize northern China's strategic position between the Central Plain and the Eurasian Steppes. Its interaction with its neighbors and its indigenous development make northern China a special area that was open to various cultural influences from surrounding areas, while at the same time, it was isolated enough to make its own developments. The frequent movement of people, goods, and ideas undoubtedly encouraged local innovation, and competition between the various cultures, or tribes with different backgrounds may have stimulated the growth of cultures with strong regional features⁸²⁸.

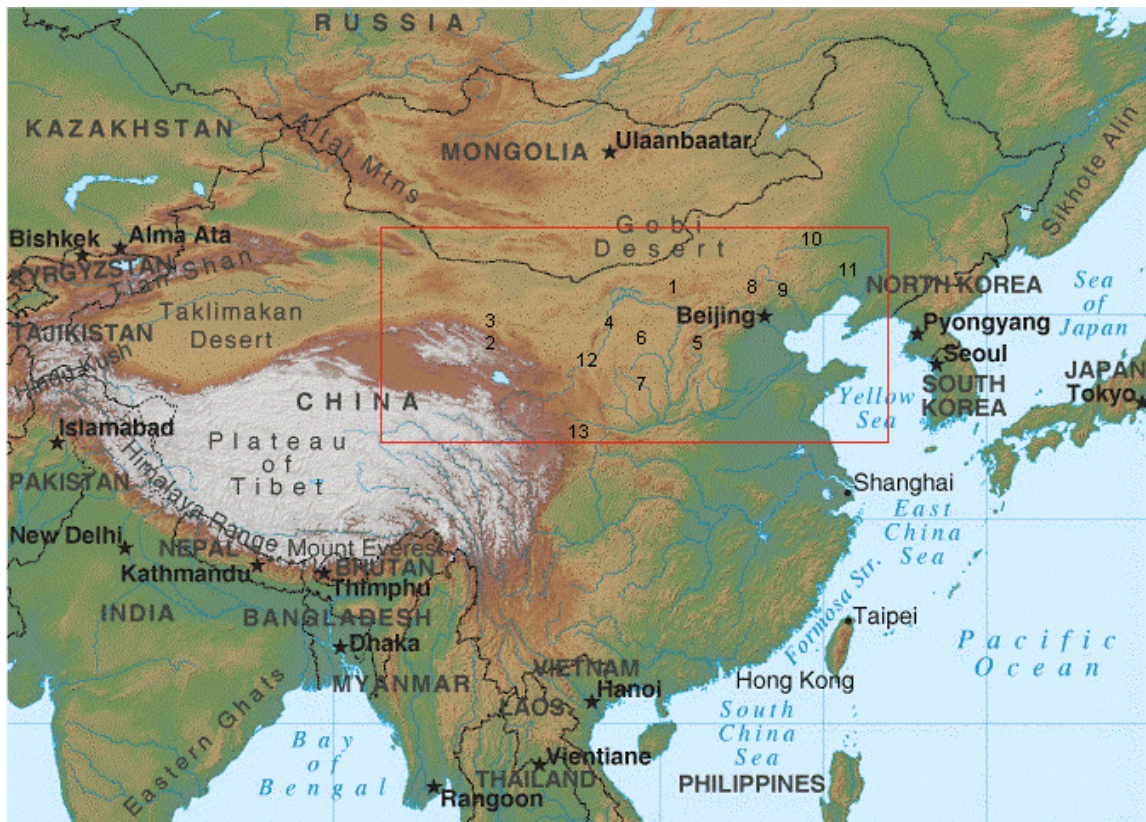
A leading Chinese scholar, Lin Yun had an amazing description on the cultural exchanges between west and east, 'the open steppe area in Central Asia is like a wonderful historical whirlpool which integrates different cultural elements with different origins into one united and stable complex; meanwhile, the elements of the complex like spume splash into the surrounding areas.'⁸²⁹

The Future

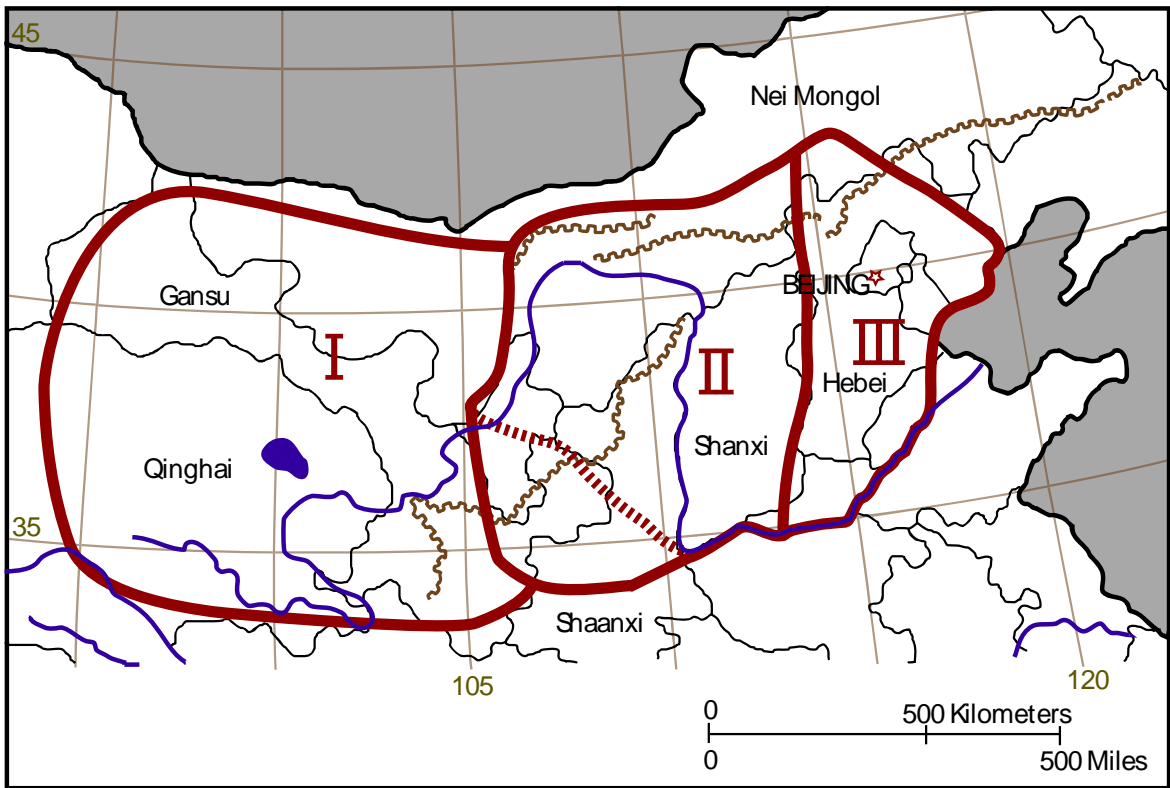
It is clear that further analysis needs to be done region by region. There is demand for more materials and metallurgical information on the north-central and the south of the Yanshan. Since the technological analysis contributed immeasurably to the discussion of cultural interactions, it is hoped that the technical analysis for published materials will be carried out soon. If more and more sites are excavated and more and more metallurgical information is available, it will be possible for us to draw a more comprehensive picture on the economic, political, and social organization of northern China within the greater background of the Eurasian Steppes.

⁸²⁸ MJJ 2000, 75.

⁸²⁹ Lin Y. 1998c, 280.

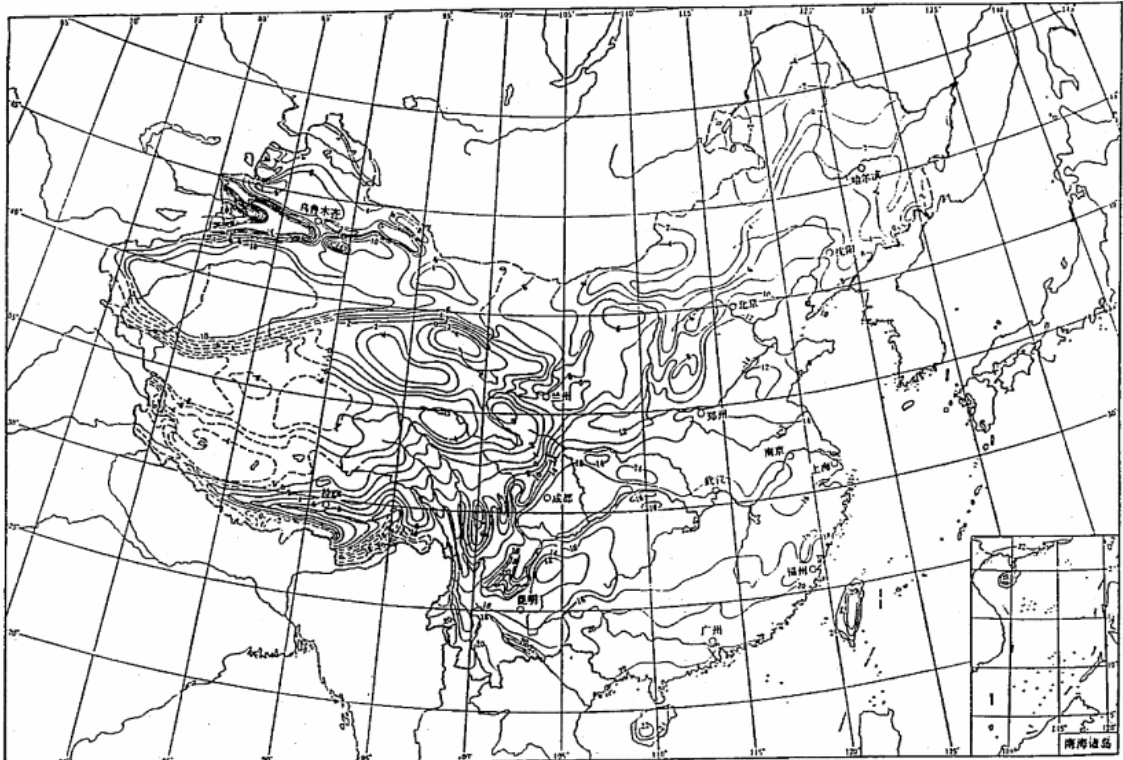


Map 1. The physical geography of northern China, 1 Yinshan; 2 Qilianshan; 3 Hexi Corridor; 4 Helanshan; 5 Taihang Shan; 6 Ordos Plateaus; 7 Loess Plateau; 8 Yanshan; 9 Liaoh; 10 Xilamulunhe; 11 Xiliaohe; 12 Yellow River; 13 Weihe.

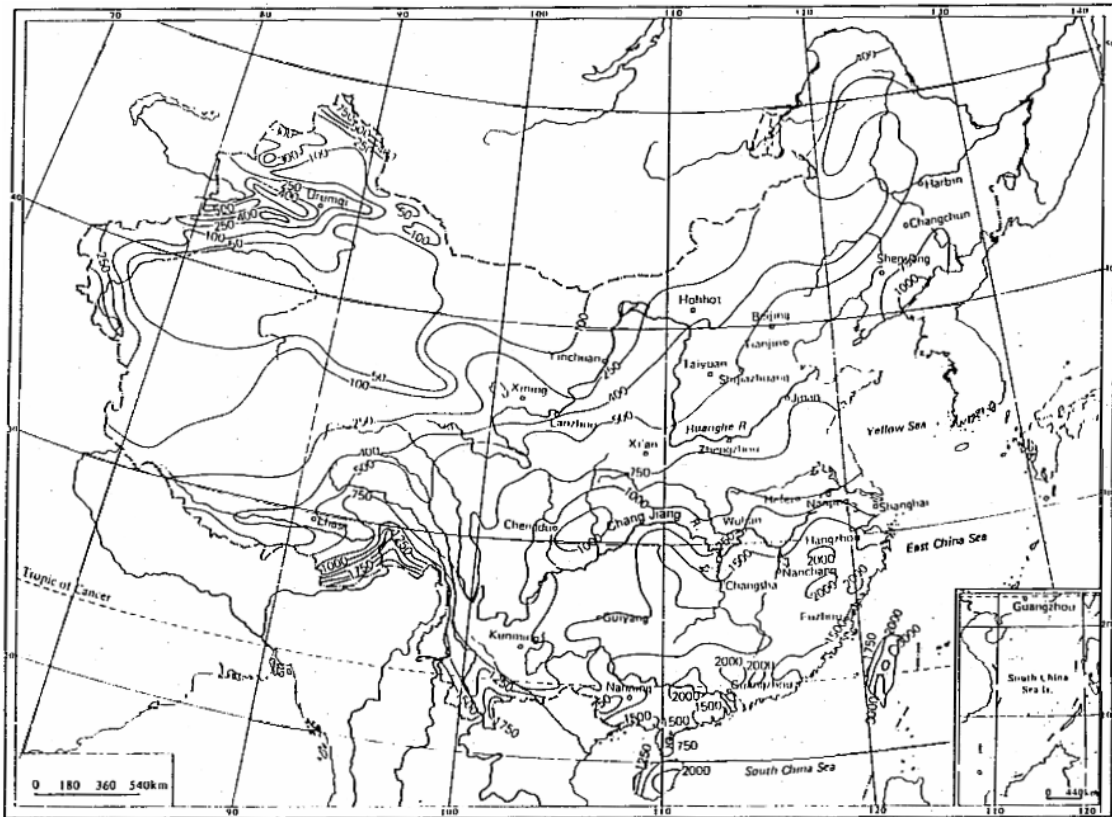


LEGEND	
	present provincial boundary
	the Great Wall
	rivers and lakes
	boundary of sub-regions suggested by this study
	boundary of sub-division of North-central Complex
I	Northwest Complex
II	North-central Complex
III	South of the Yanshan Complex

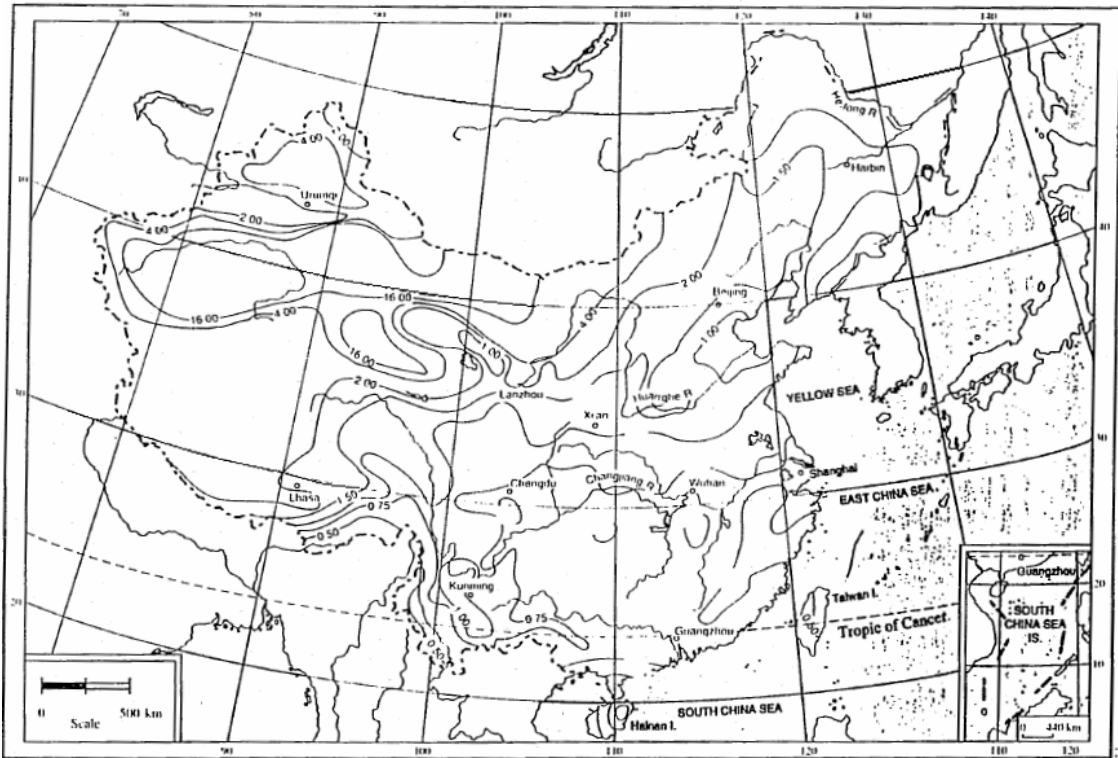
Map 2. Sub-regions of northern China in this study.



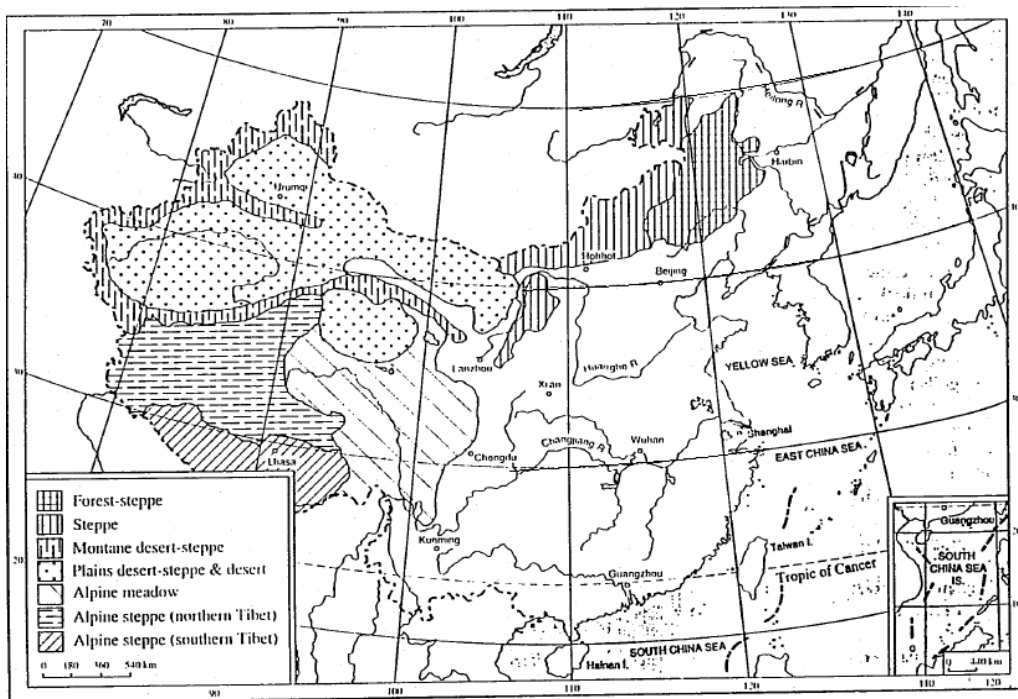
Map 3. Distribution of annual mean temperature (°C) in China (after Pak Y. J. 41 Map 2.6).



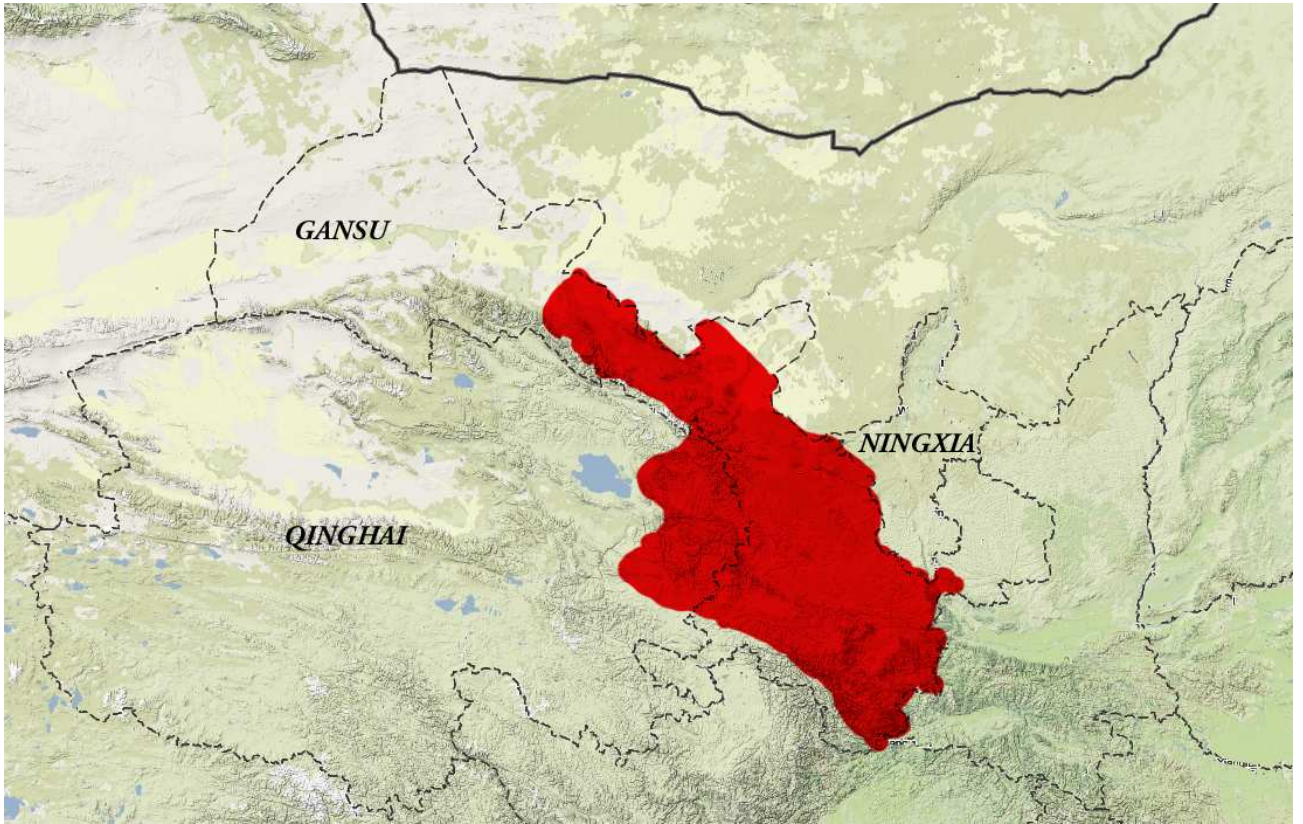
Map 4. Distribution of annual precipitation (mm) in China (after Pak Y. J. 1996, 43 Map 2.8).



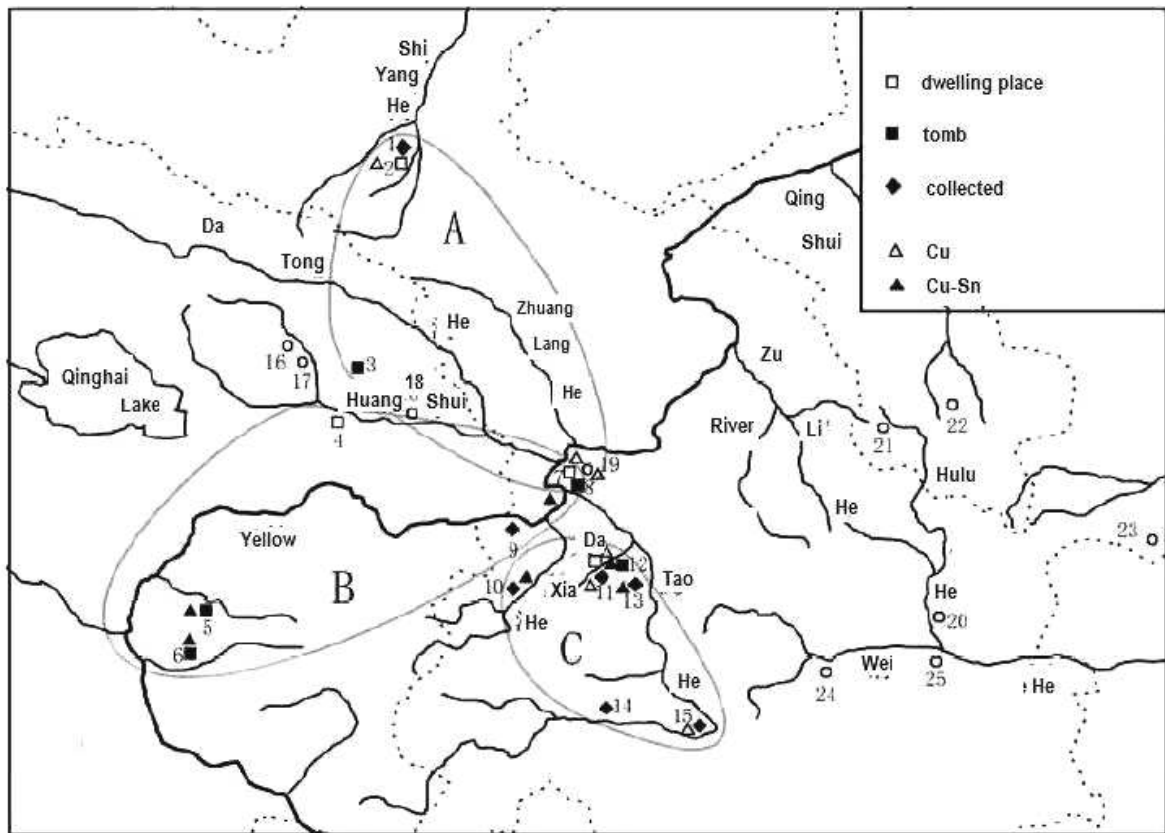
Map 5. Distribution of aridity indices in China (after Pak Y. J. 1996, 44 Map 2.9).



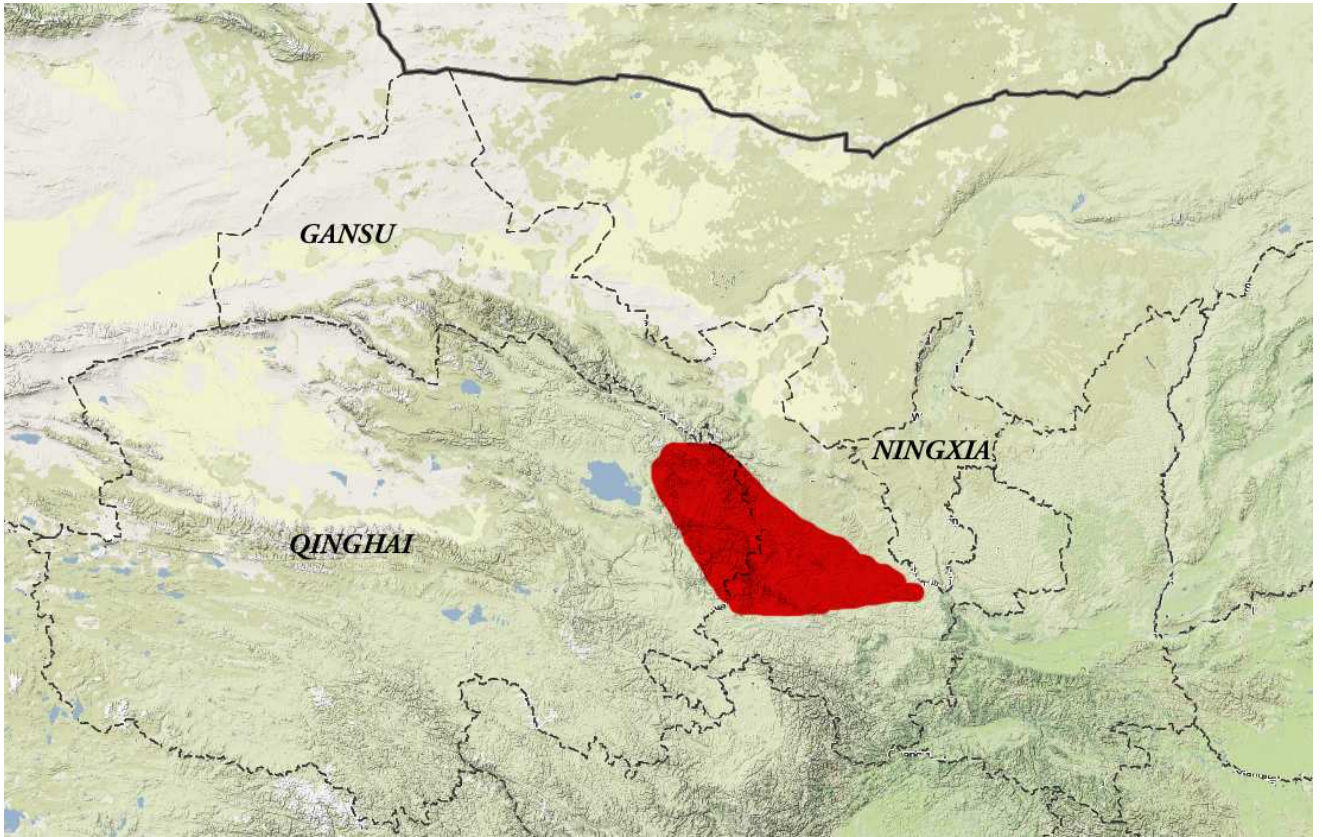
Map 6. Distribution of major grassland types in China (after Pak Y. J. 1996, 46 Map 2.11).



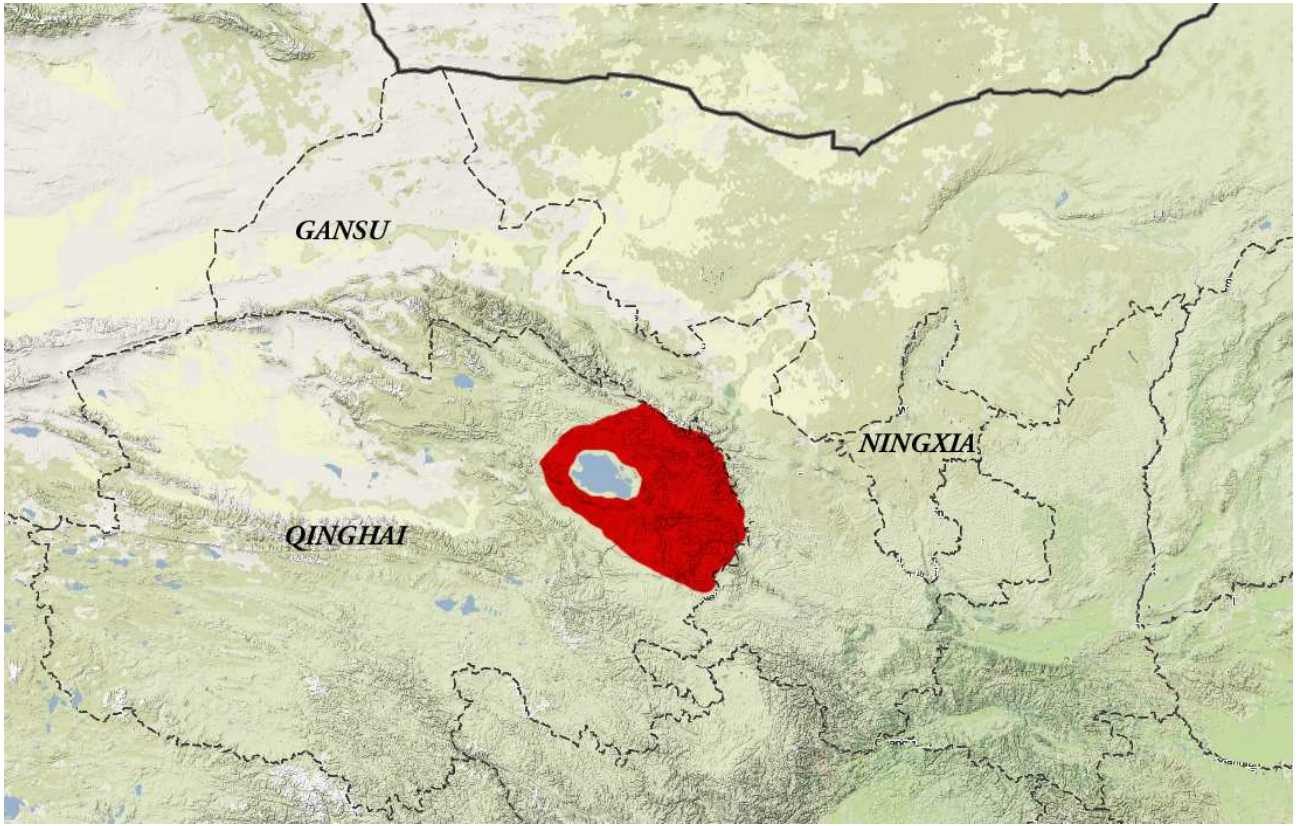
Map 7 Distribution of the Qijia culture .



Map 8. The Qijia culture sites that were discovered with bronze objects: 1 Haizangsi; 2 Huangniangniantai; 3 Zongzhai; 4 Shenna; 5 Gamatai; 6 Zongri; 7 Dahezhuang; 8 Qinweijia; 9 Xinzhuangping; 10 Weijiataizi; 11 Xiping; 12 Qijiaping; 13 Shangguandi, Kangle; 14 Chenqimogou; 15 Xinglin; 16 Huangjiazhai; 17 Shangsunjiazhai; 18 Liuwan; 19 Zhangjiazui, Jijiachuan; 20 Sizui ping; 21 Xinglong town; 22 Haijiawan; 23 Qiao village; 24 Fujiamen; 25 Shizhao, Xishanping.



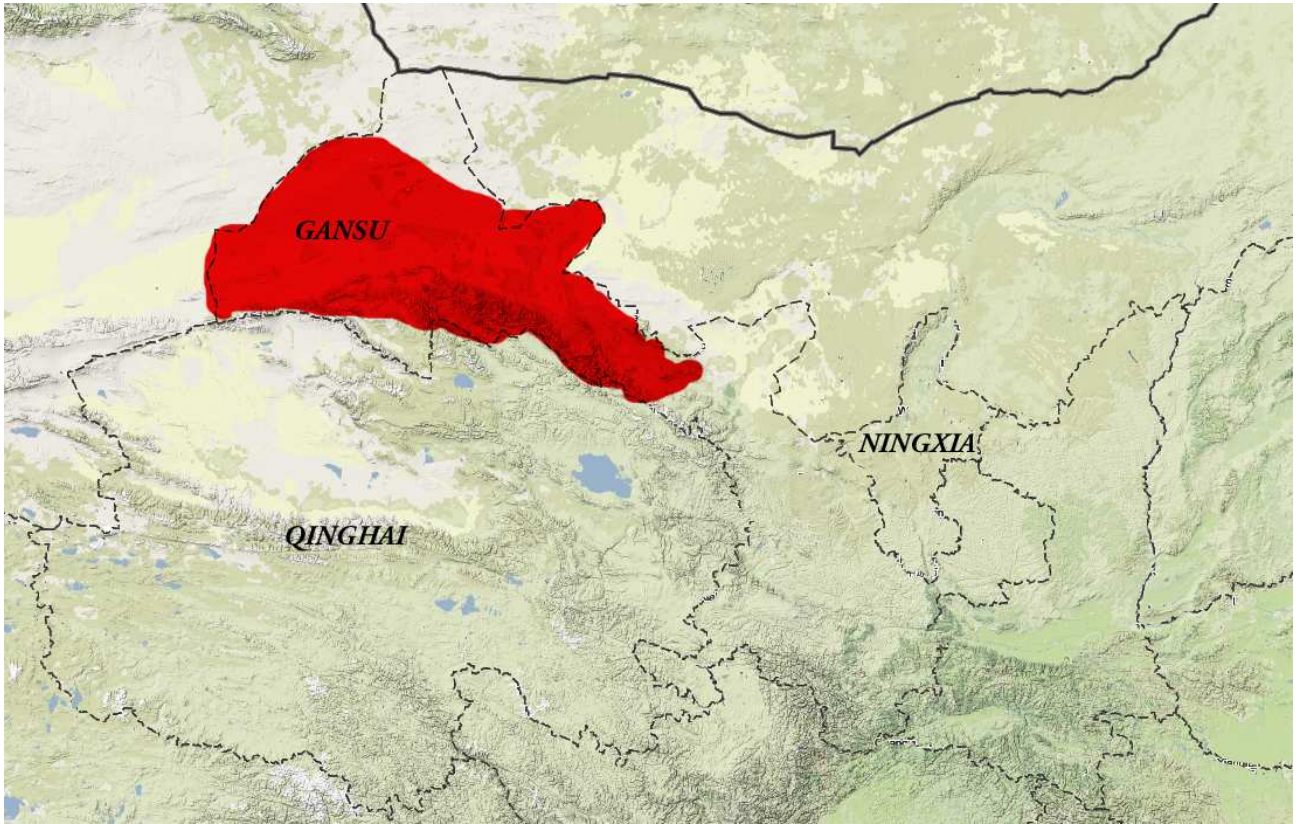
Map 9. Distribution of the Xindian culture



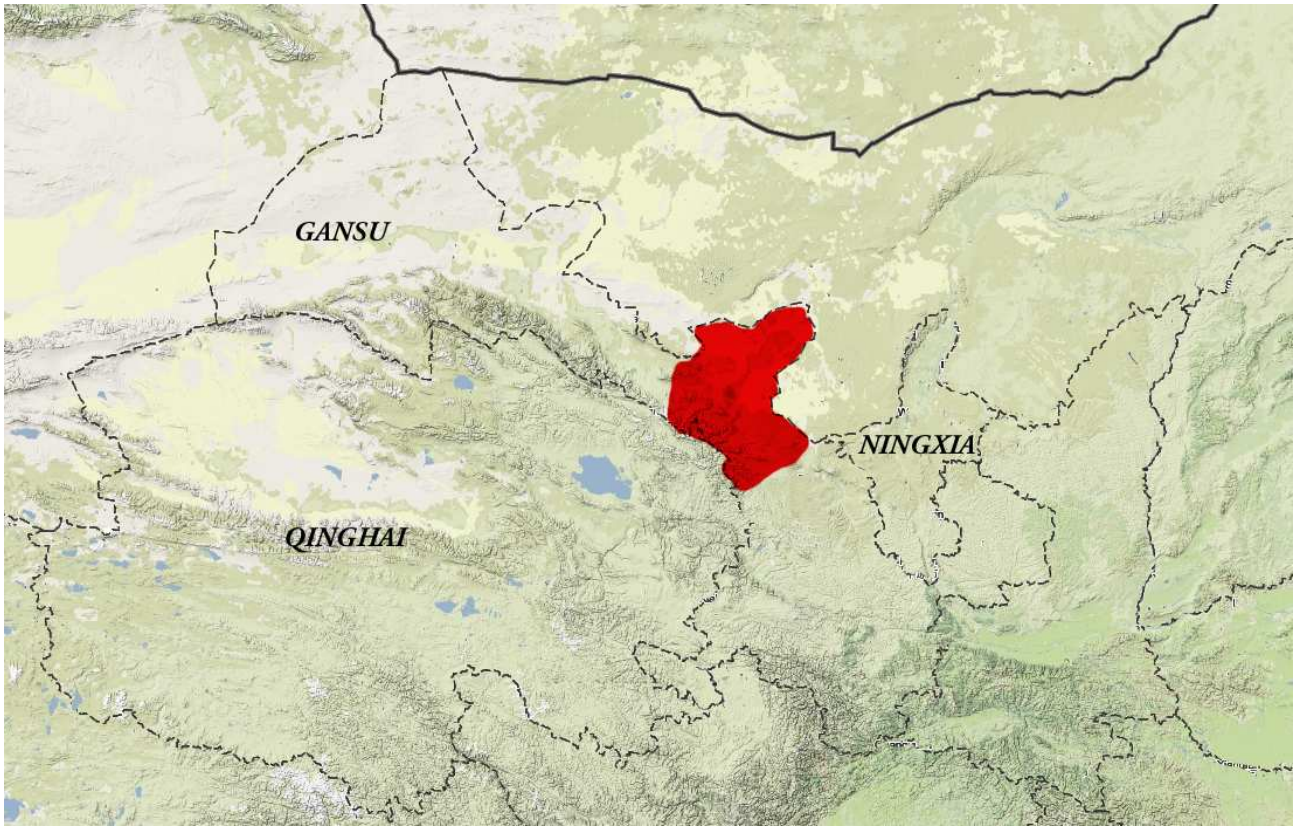
Map 10. Distribution of the Kayue culture.



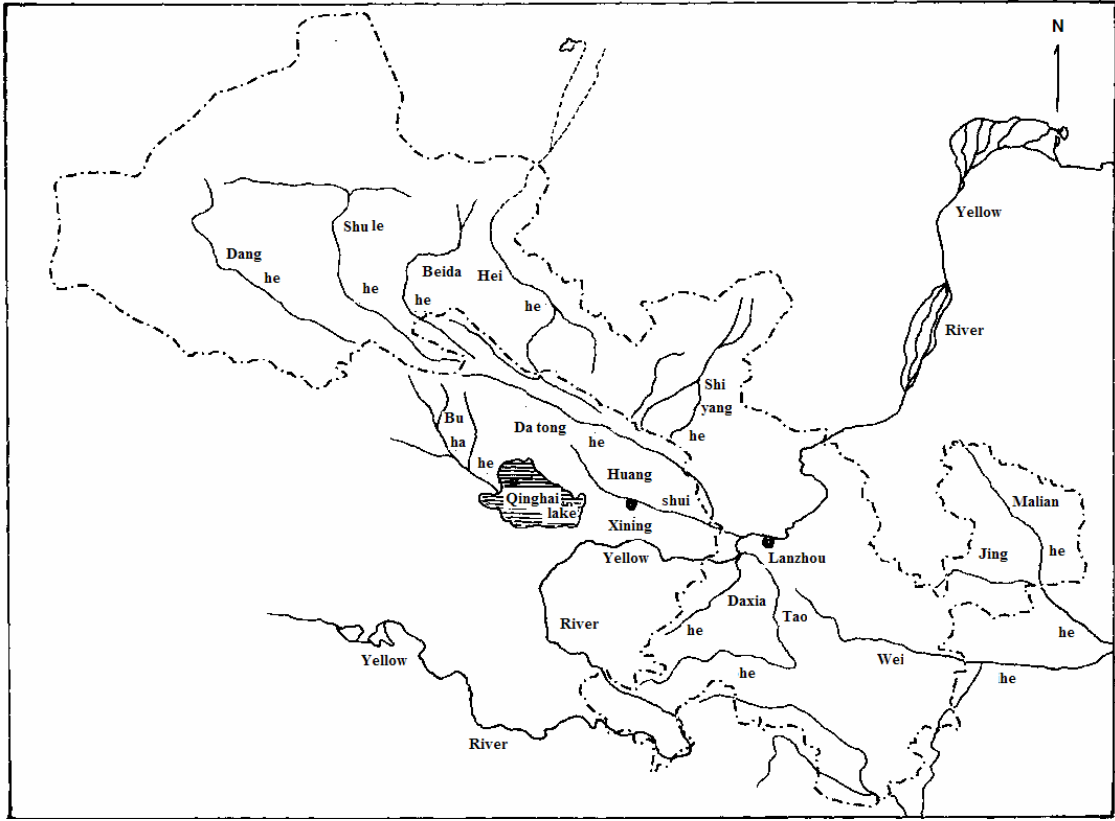
Map 11. Distribution of the Siwa culture (after Shui T. 2001a, 221 Fig. 18).



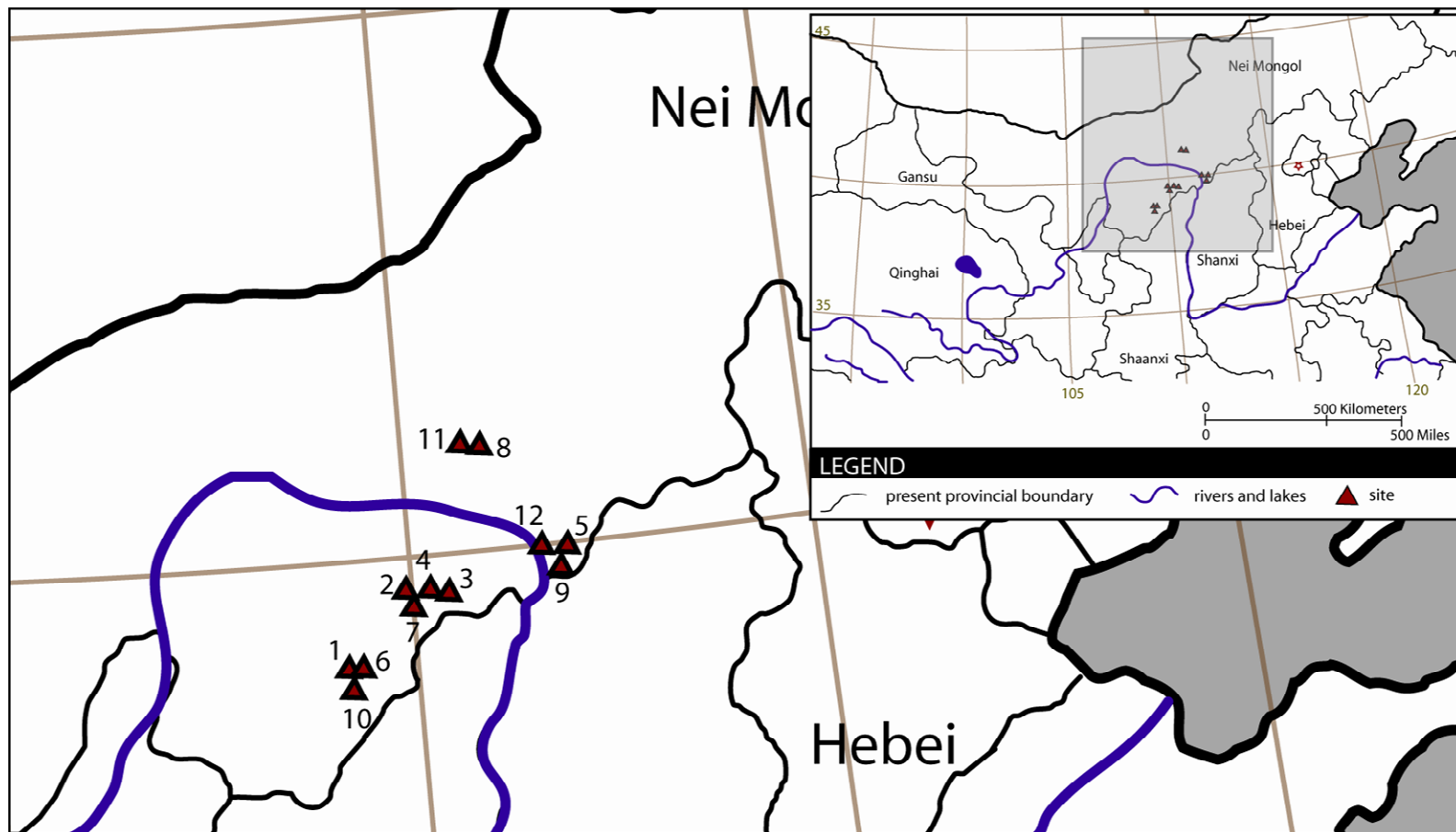
Map 12. Distribution of the Siba culture



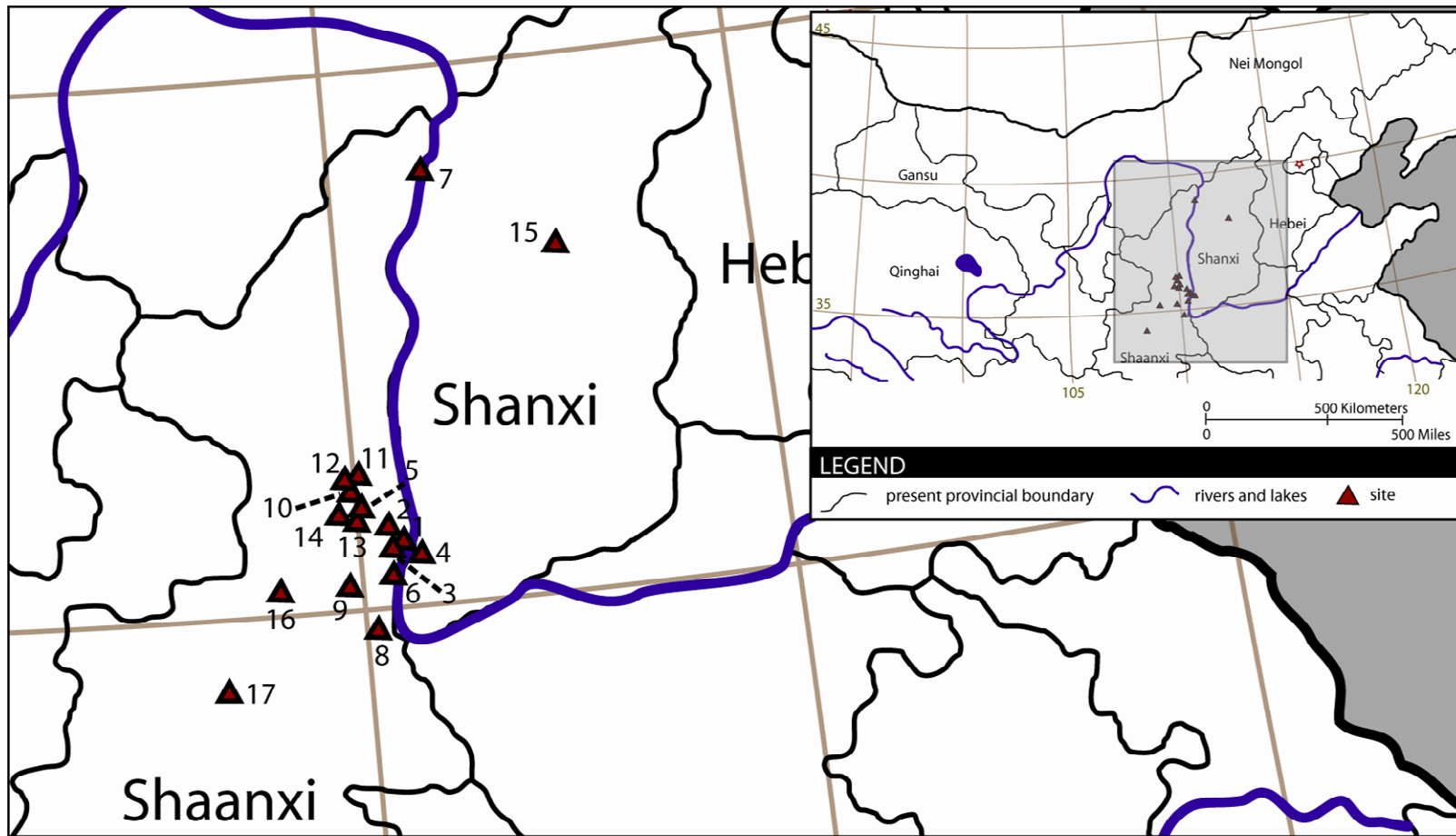
Map 13. Distribution of the Shajing culture.



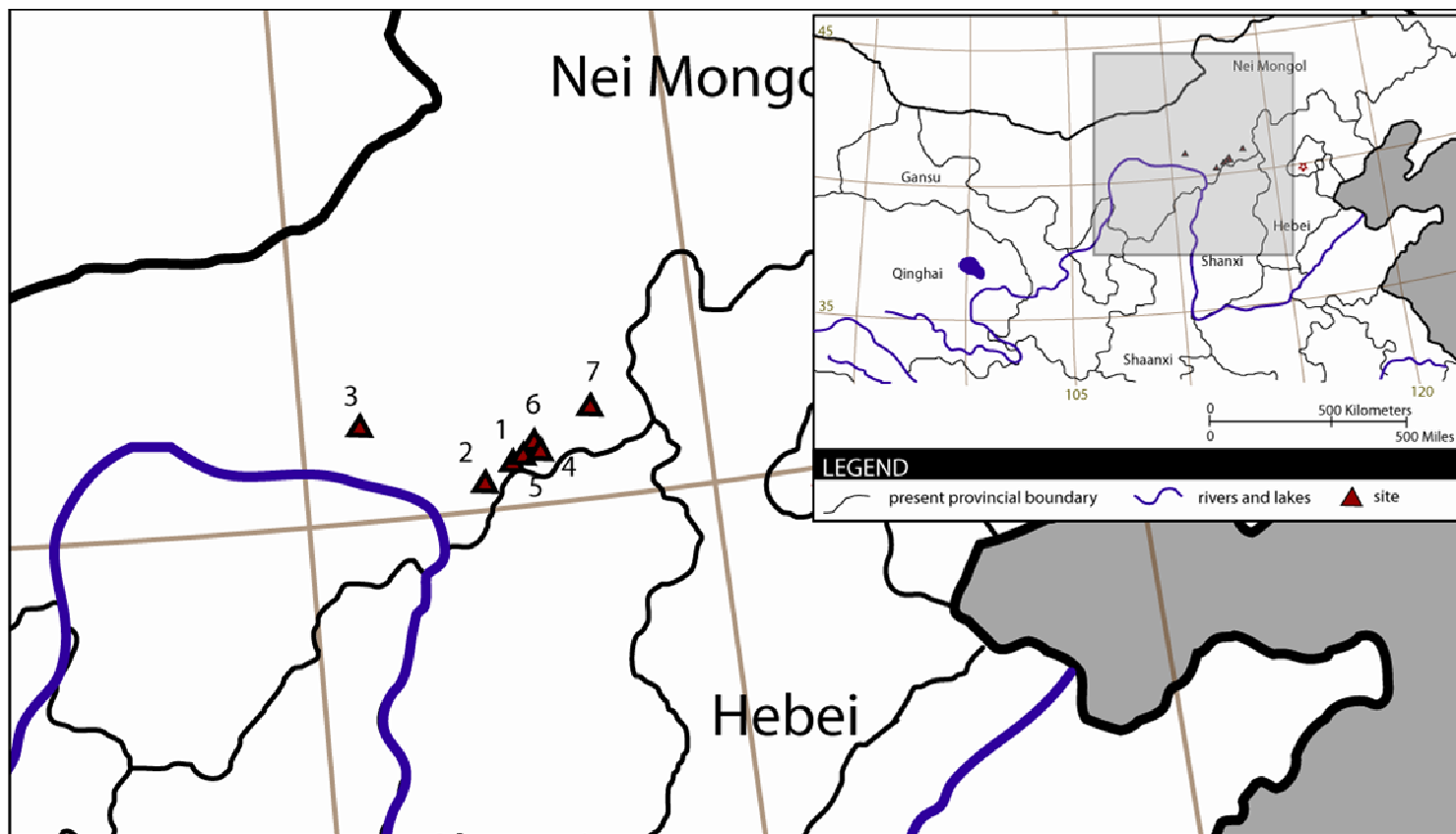
Map 14. Geography of northwest China.



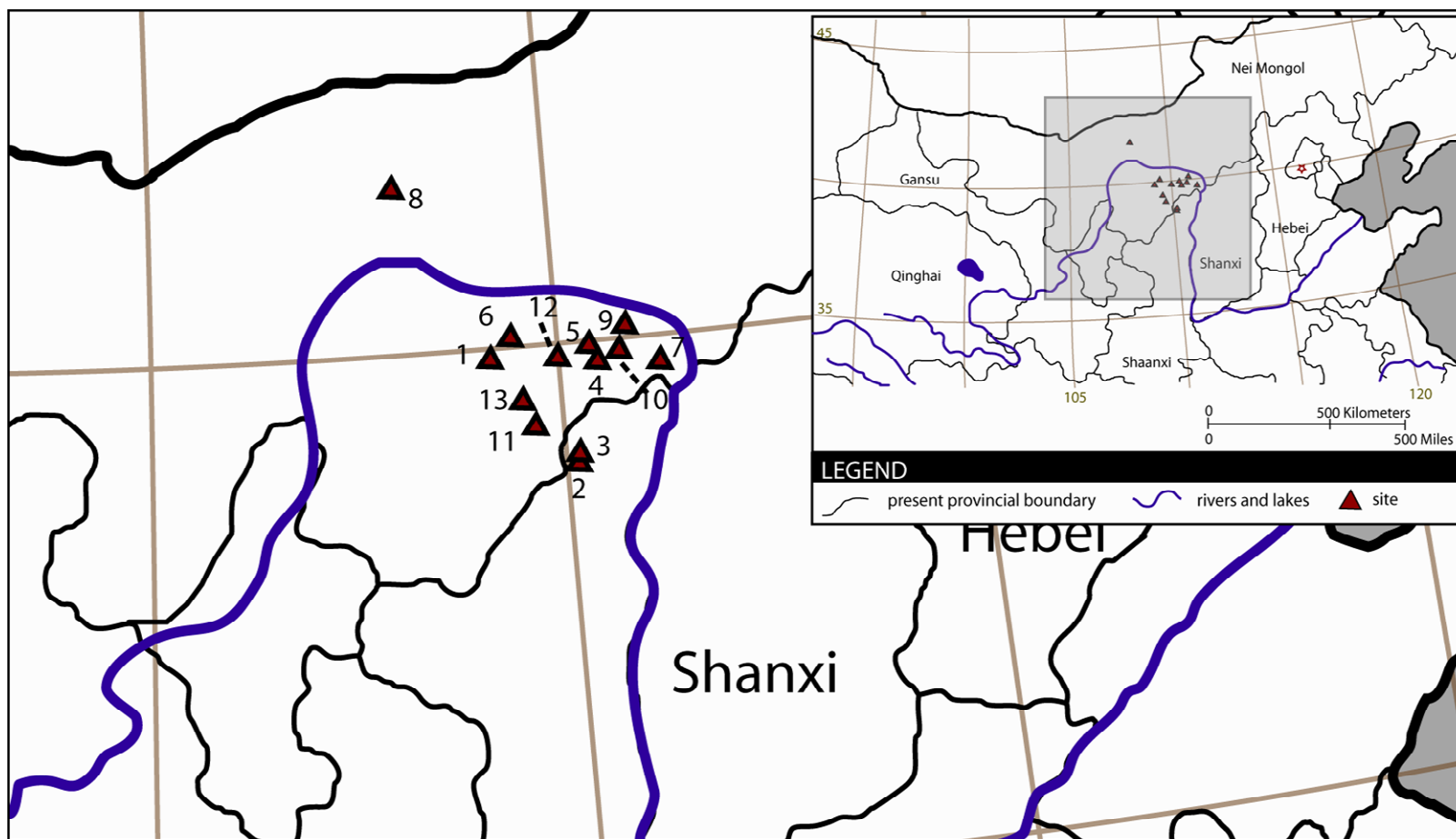
Map 15. Distribution of the Zhukaigou culture and the Xicha culture, 1 Zhukaigou; 2 Erliban; 3 Nanhao; 4 Gaojiaping; 5 Baiaobao; 6 Bainiyaozi; 7 Zhaizita; 8 Yangchangou; 9 Zhuangwoping; 10 Guandi; 11 Haishengbulang; 12 Xicha.



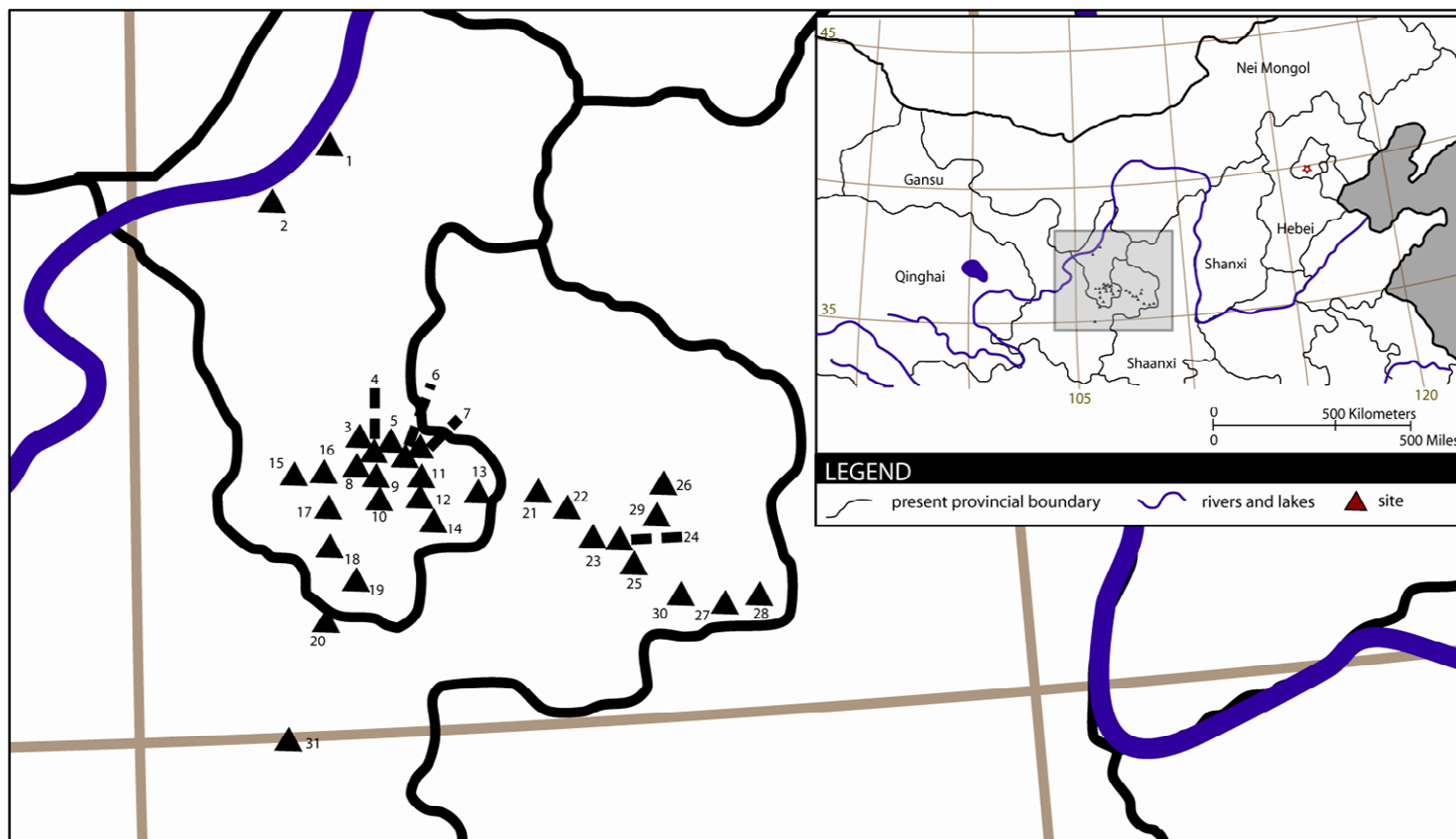
Map 16. Distribution of the Lijiaya culture, 1 Erlangpo; 2 Houlanjiagou; 3 Taohuazhuang; 4 Caojiayuan; 5 Yidie; 6 Xiaxinjiao; 7 Lindeyu; 8 Shangdong; 9 Zhanglangou; 10 Lijiata; 11 Yantou; 12 Hourenjiagou; 13 Xiejiagou; 14 Lijiaya; 15 Yangquanpo; 16 Siyan; 17 Heidouzui.



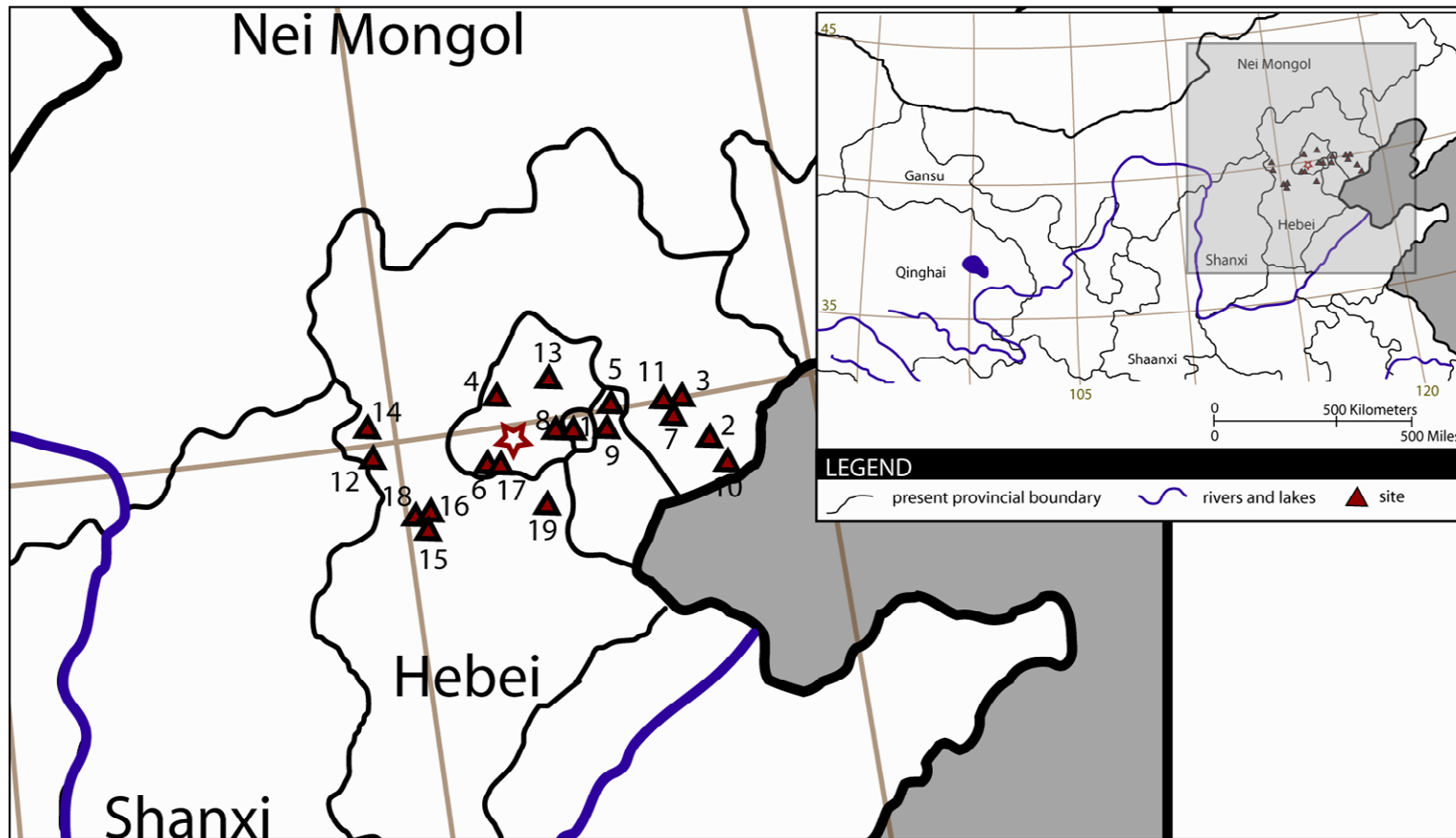
Map 17. Distribution of the Maoqinggou culture, 1 Maoqinggou; 2 Fanjiayaozi; 3 Shuijiangoumen; 4 Qiandesheng; 5 Yinniugou; 6 Guoxianyaozi; 7 Goulitou.



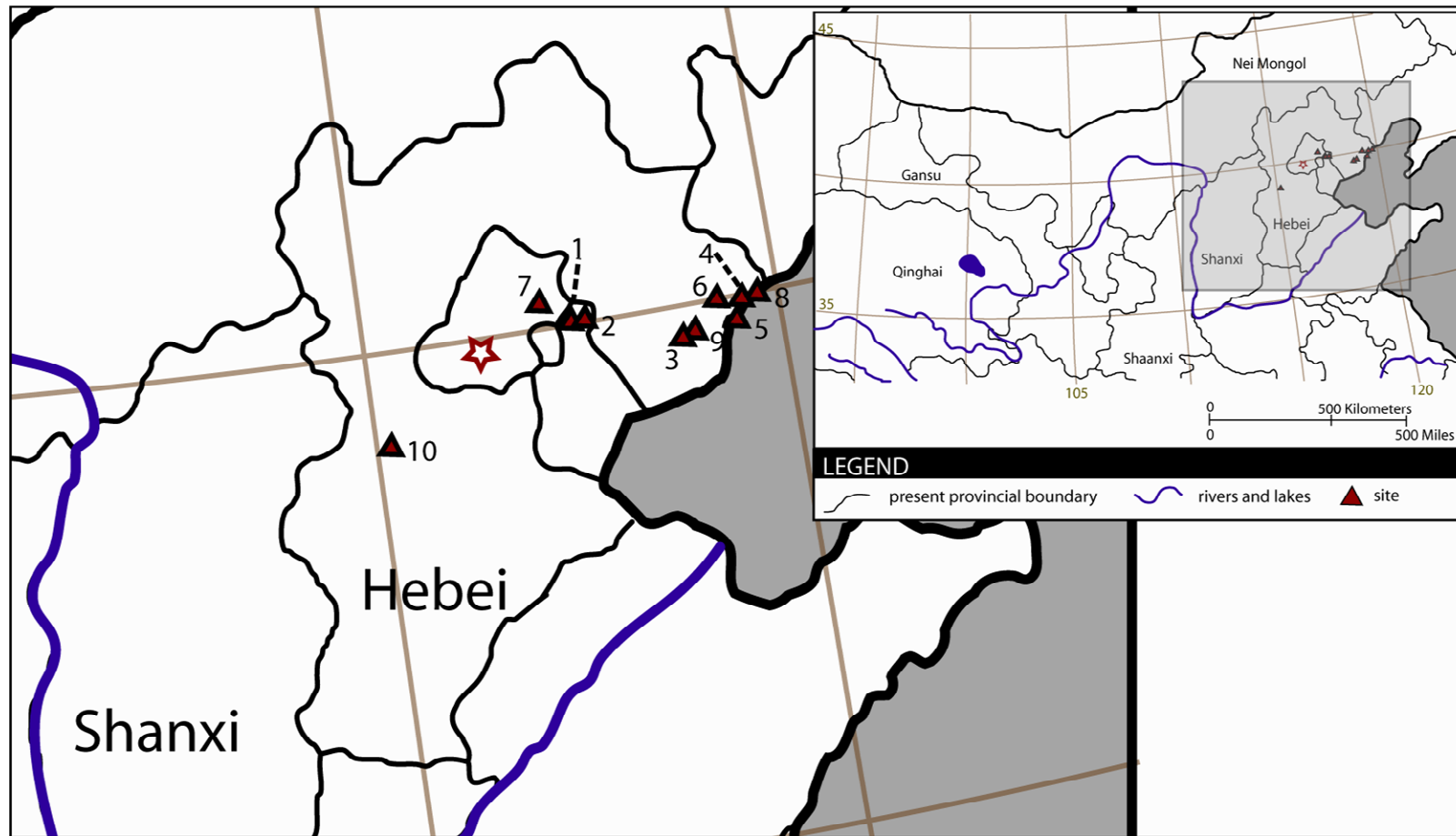
Map 18. Distribution of the Taohongbala culture, 2 Nalingaotu; 3 Lijiapan; 4 Waertugou; 5 Sujigou; 6 Aluchaideng; 7 Yulongtai; 8 Hulusitai; 9 Xigoupan; 10 Baohaishe; 11 Shihuigou; 12 Nianfangqu; 13 Ming'anmudu.



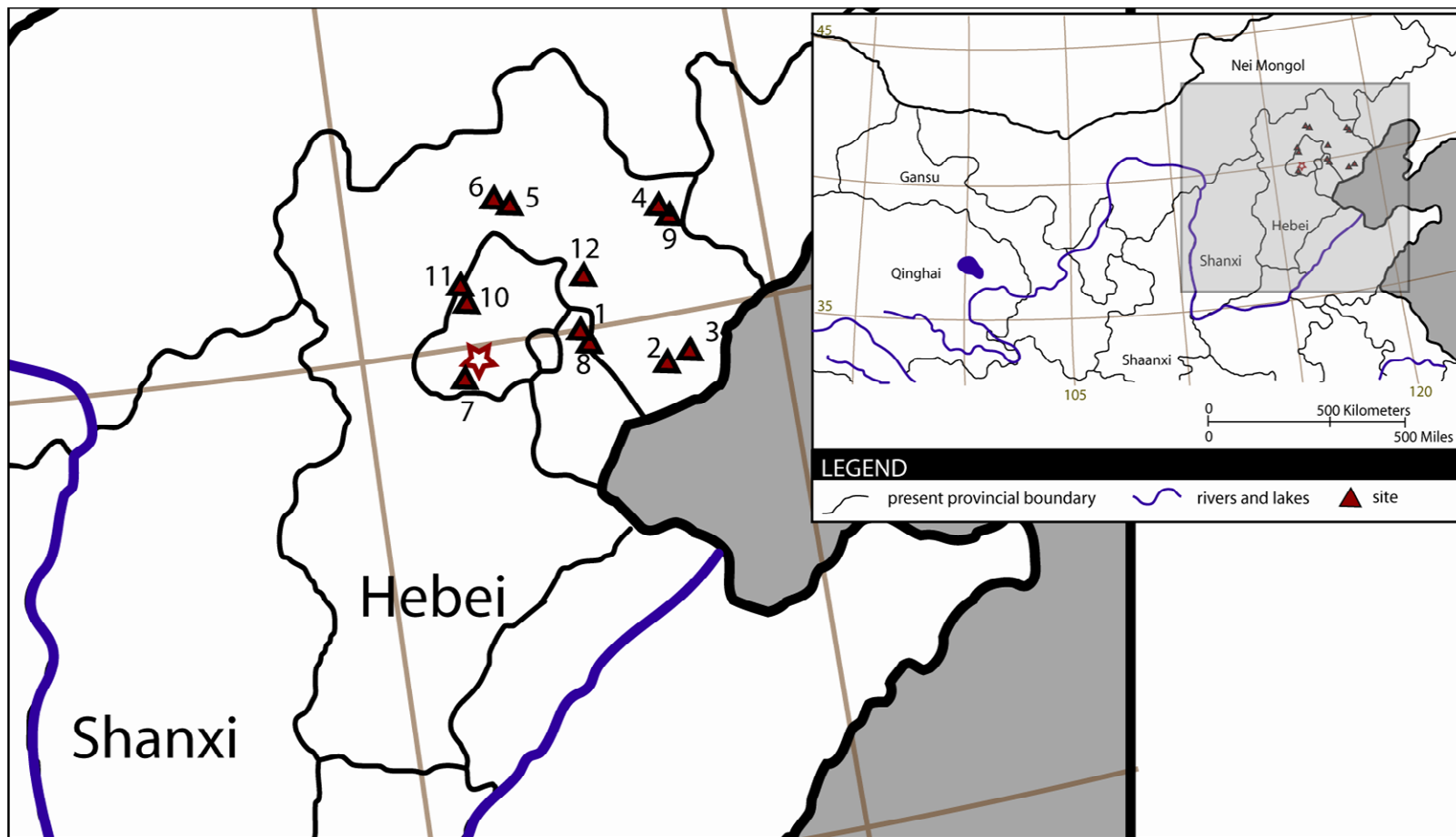
Map 19. Distribution of the Yanglang culture, 1 Nidingcun; 2 Langwozikeng; 3 Mazhuang; 4 Yujiashuang; 5 Jianghe; 6 Dabeishan; 7 Wangjiaping; 8 Houmocun; 10 Tianwacun; 11 Luzizuigou; 12 Luzigou; 13 Yumengxiang; 14 Baiyangcun; 15 Chenyangchuan; 16 Banzigoucun; 17 Shangdiancun; 18 Danbeicun; 19 Jizhuangchang; 20 Wugoucun; 21 Miaoqocun; 22 Wujiagouquan; 23 Hongyancun; 24 Mazhai; 25 Fengbaocun; 26 Wulipo; 27 Yujiacun; 28 Houzhuang; 29 Ligou; 30 Tatou; 31 Shanwangjiacheng.



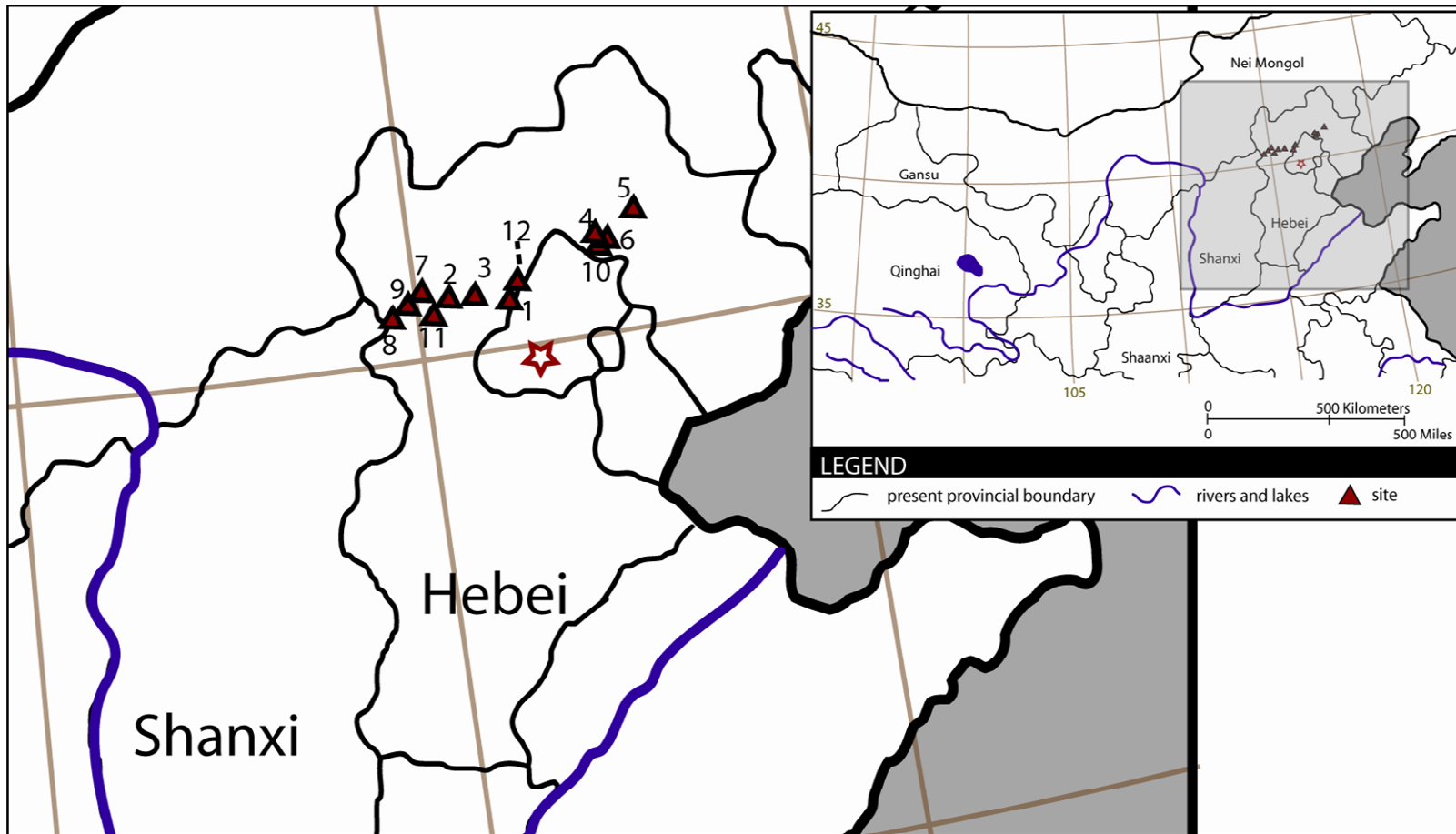
Map 20. Distribution of the Datuotou culture, 1 Dachan; 2 Xiaoguanzhuang; 3 Dachengshan; 4 Xueshan; 5 Zhangjiayuan; 6 Liulidian; 7 Weifang; 8 Liujahe; 9 Niudaokou; 10 Dongzhuangdian; 11 Guye; 12 Sanguan; 13 Fenghuangshan; 14 Lidarenzhuang; 15 Xiayuegezhuang; 16 Pangjahe; 17 Tazhao; 18 Jiancun; 19 Qinggongtai.



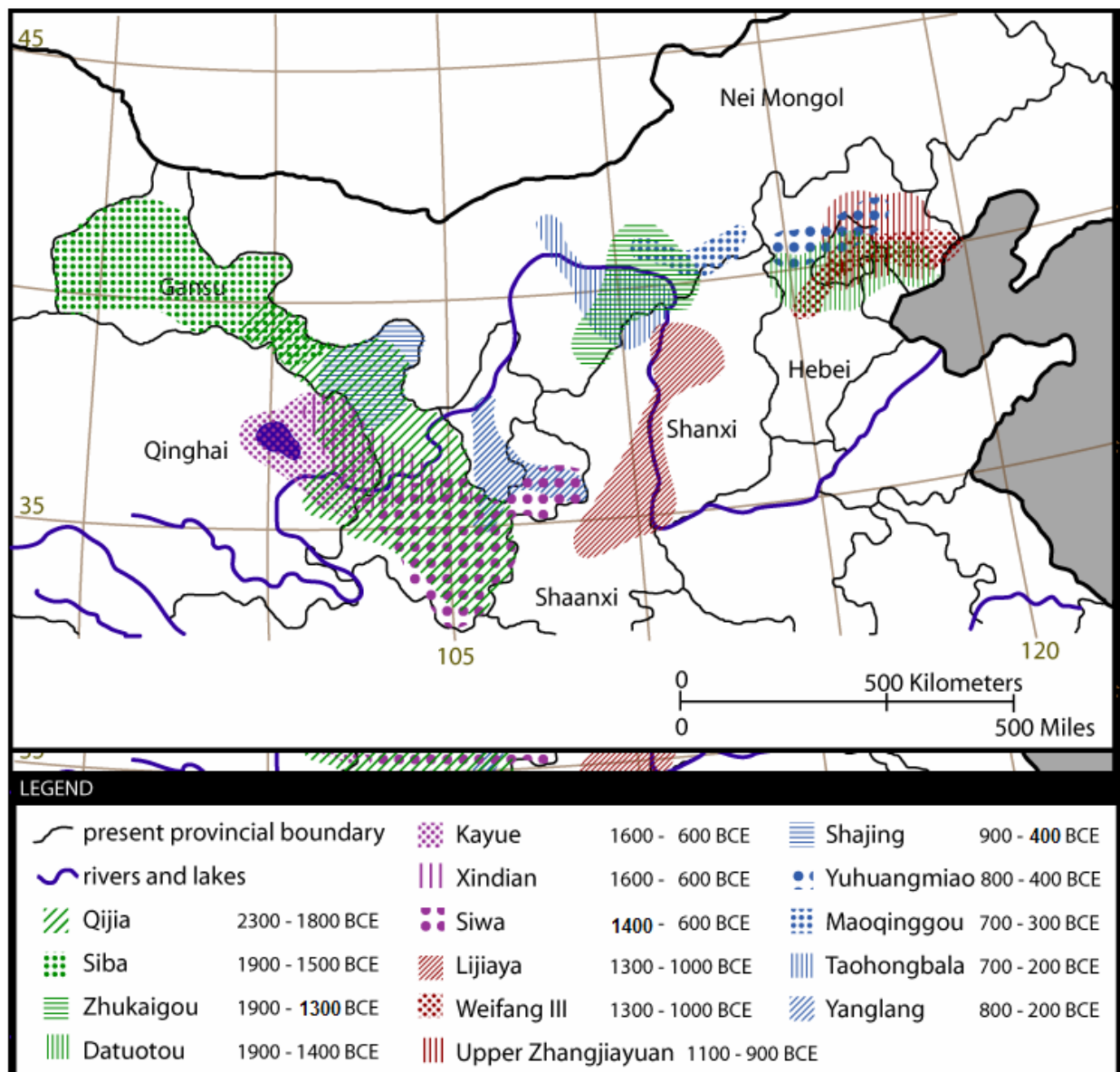
Map 21. Distribution of the Weifang III culture, 1 Bangjun; 2 Weifang; 3 Mashao; 4 Geshan'gezhuang; 5 Chenshantou; 6 Xiaoshandongzhuang; 7 Liujiahe; 8 Chaodaogou; 9 Guye; 10 Laishui.



Map 22. Distribution of the Upper Zhangjiayuan culture, 1 Zhangjiayuan; 2 Baohaishe; 3 Guye; 4 Liushugou; 5 Niuquanziliang; 6 Dongdaogouxia; 7 Zhenjiangying; 8 Liujiafen; 9 Dongnangou; 10 Baifu; 11 Xibozi; 12 Xiaohenan.



Map 23. Distribution of the Yuhuangmiao culture, 1 Yuhuangmiao; 2 Beixinbao; 3 Ganzibao; 4 Qingzigou; 5 Luotuoliang; 6 Paotaishan; 7 Baimiao; 8 Nihezi; 9 Xiaobaiyang; 10 Lishugoumen; 11 Daolazui; 12 Longqingxia.



Map 24. Bronze-using cultures in northern China during the 4th and 3rd millennia B. P. .



Map 25. Territory of the Shang Dynasty (from <http://www.chinahighlights.com/map/ancient-china-map/shang-dynasty-map.htm>).



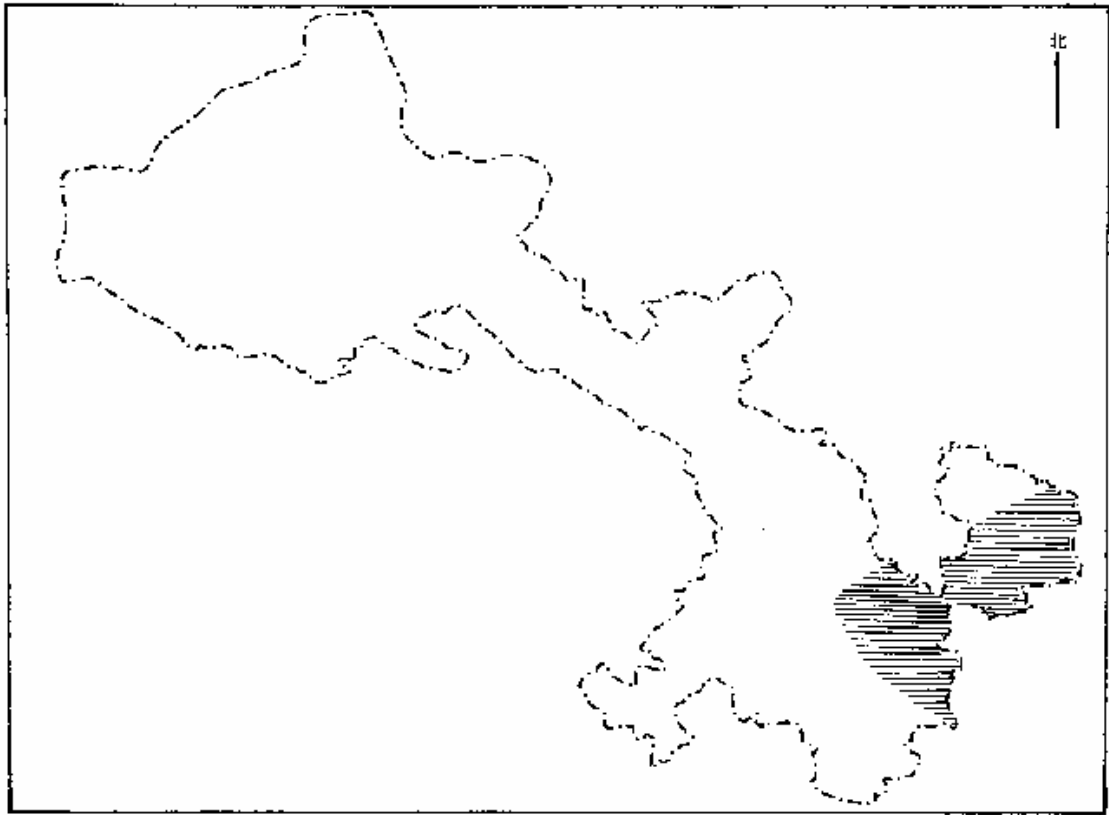
Map 26. Territory of the Western Zhou Dynasty (from <http://www.chinahighlights.com/map/ancient-china-map/western-zhou-dynasty-map.htm>).



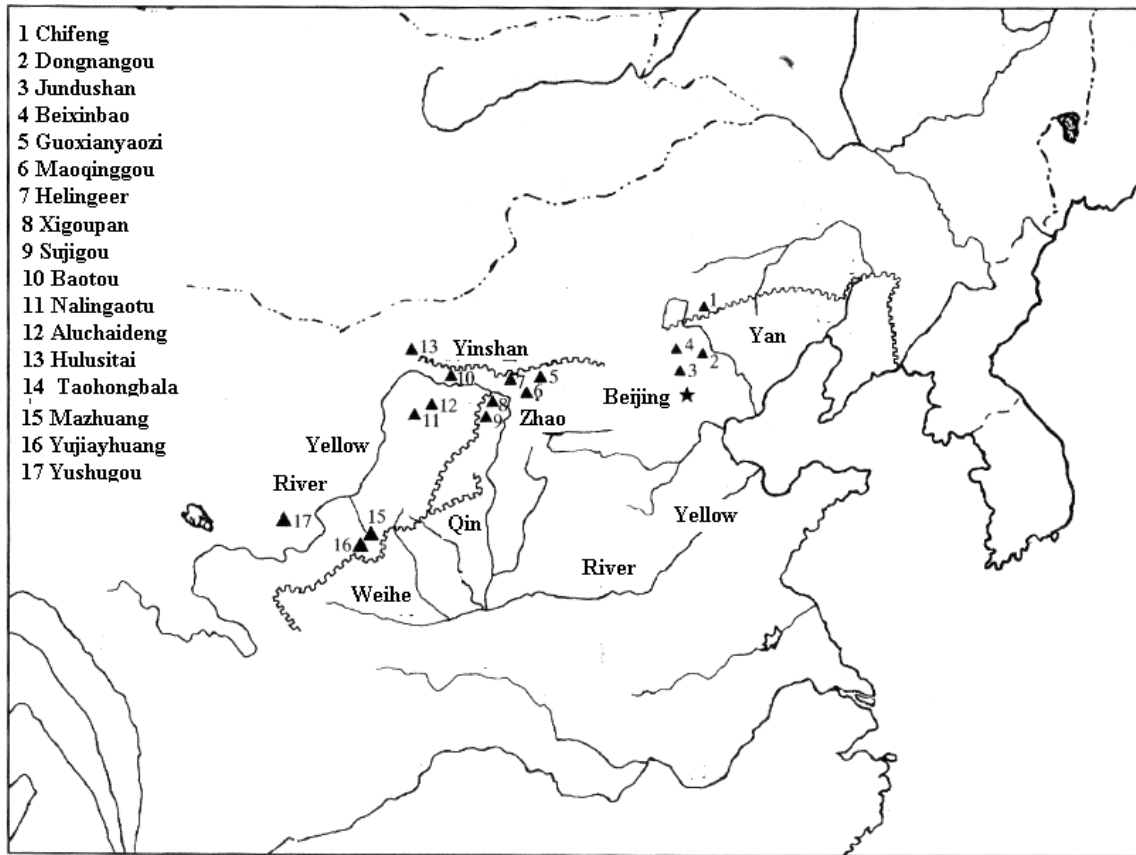
Map 27. Territory of the Eastern Zhou Dynasty (from <http://www.chinahighlights.com/map/ancient-china-map/eastern-zhou-dynasty-map.htm>).



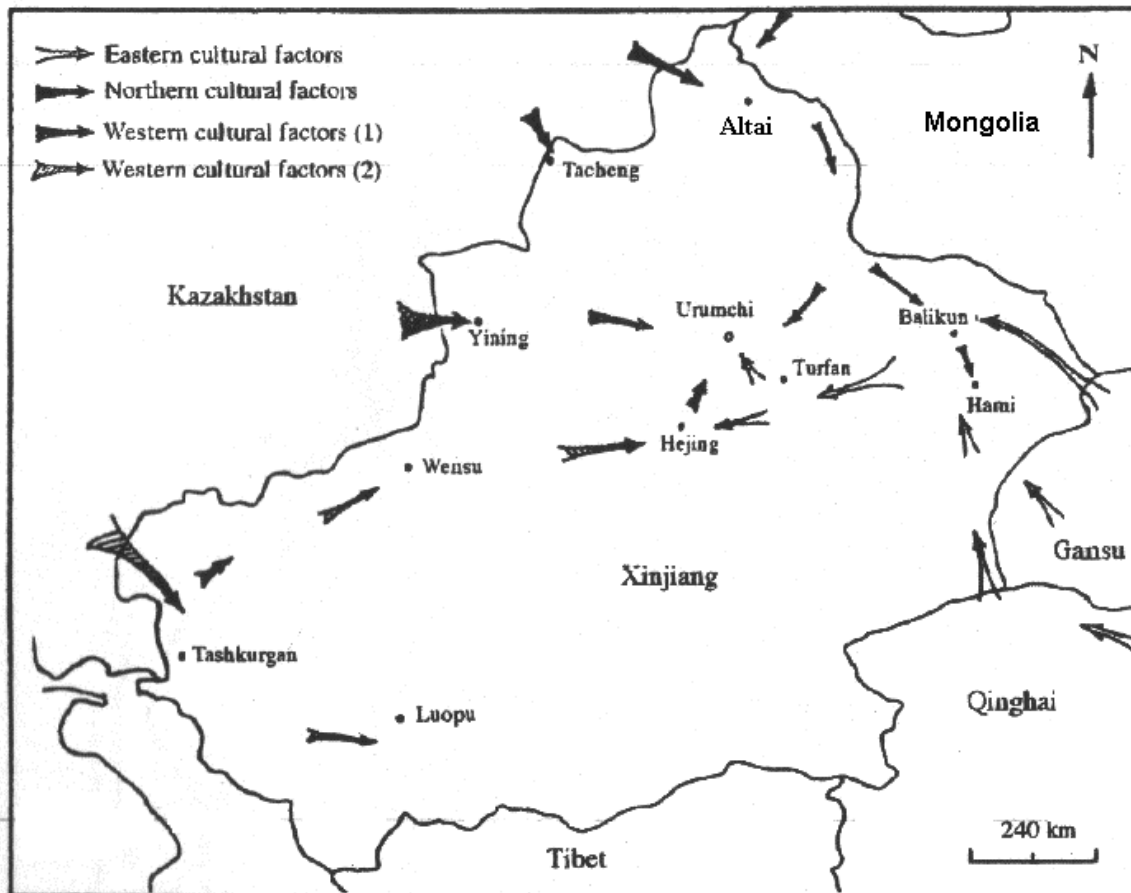
Map 28. Seven states of the Warring States (from <http://www.chinahighlights.com/map/ancient-china-map/warrior-state-dynasty-map.htm>).



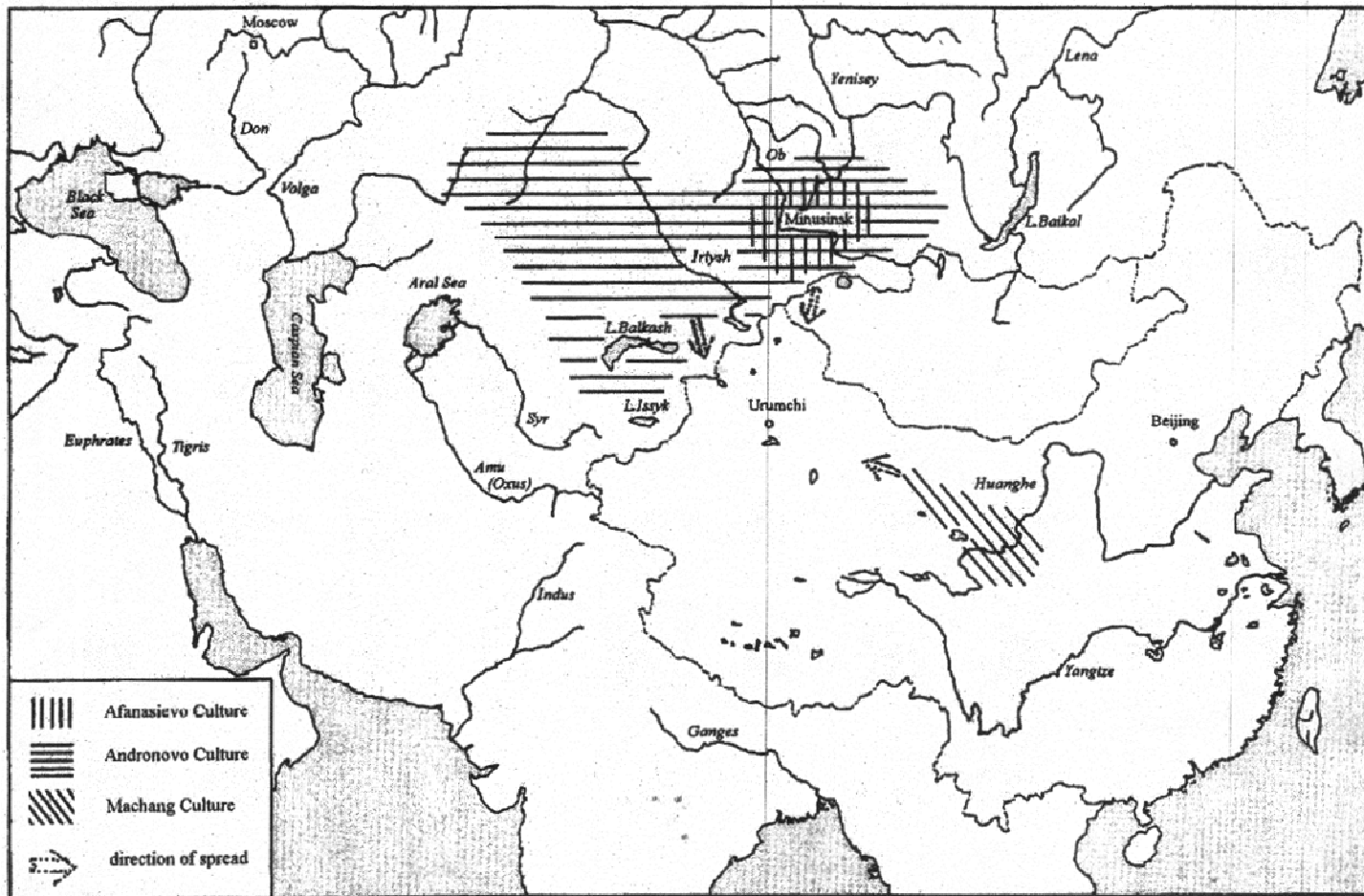
Map 29. Distribution of the Shang, Pre-Zhou and Zhou cultures (after Shui T. 2001a, 258 Fig. 41).



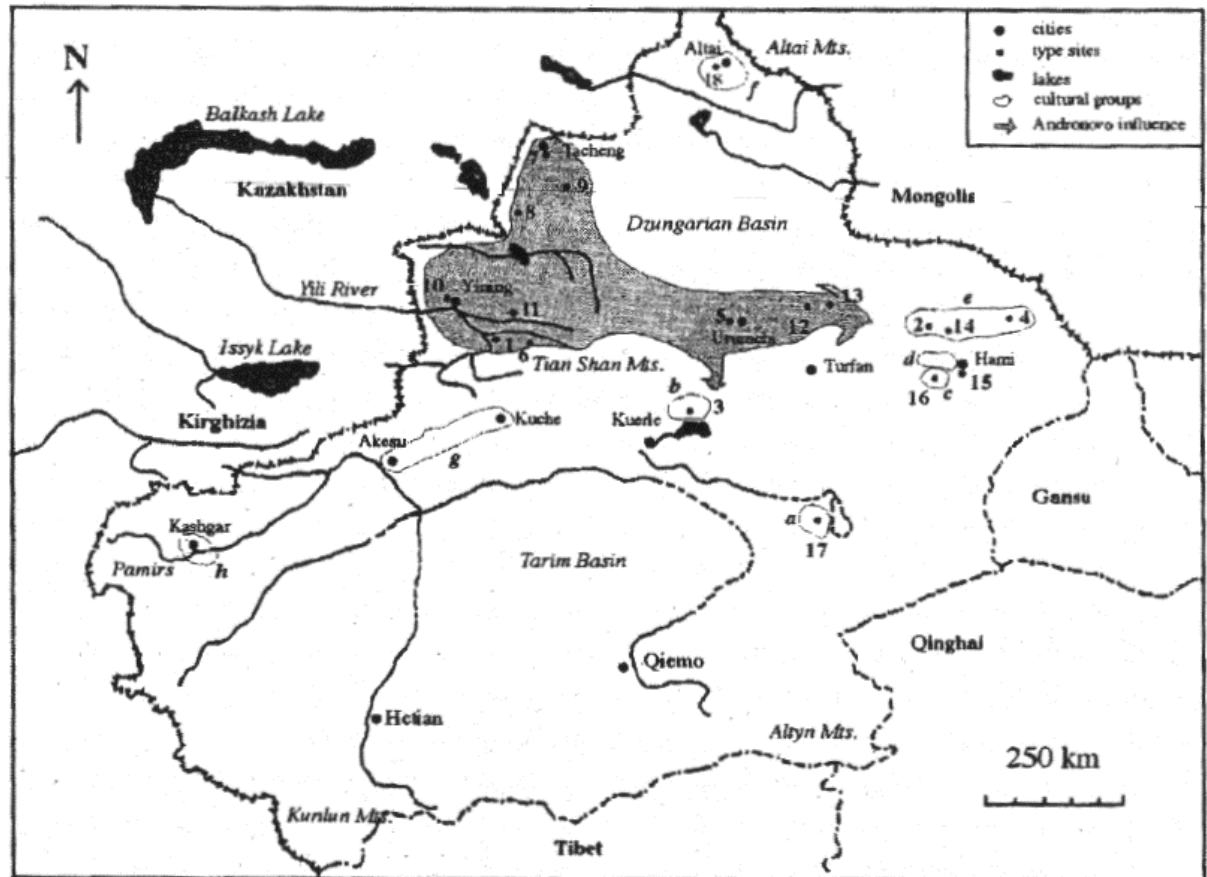
Map 30. Location of the Great Wall during the Warring States and northern culture sites.



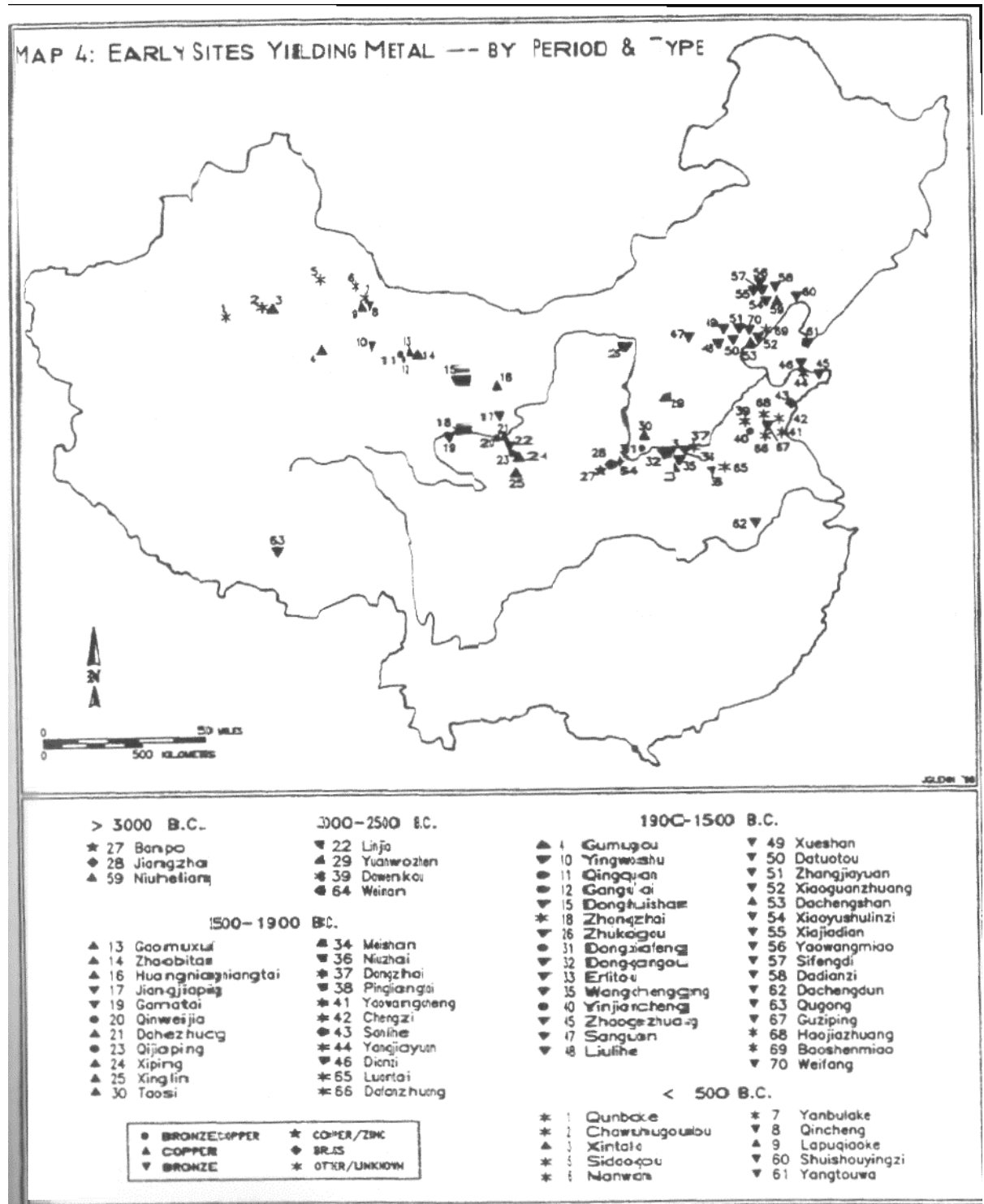
Map 31. Cultural influence on prehistoric Xinjiang from the neighboring regions (after MJJ 2000, 78 Fig. 1.1).



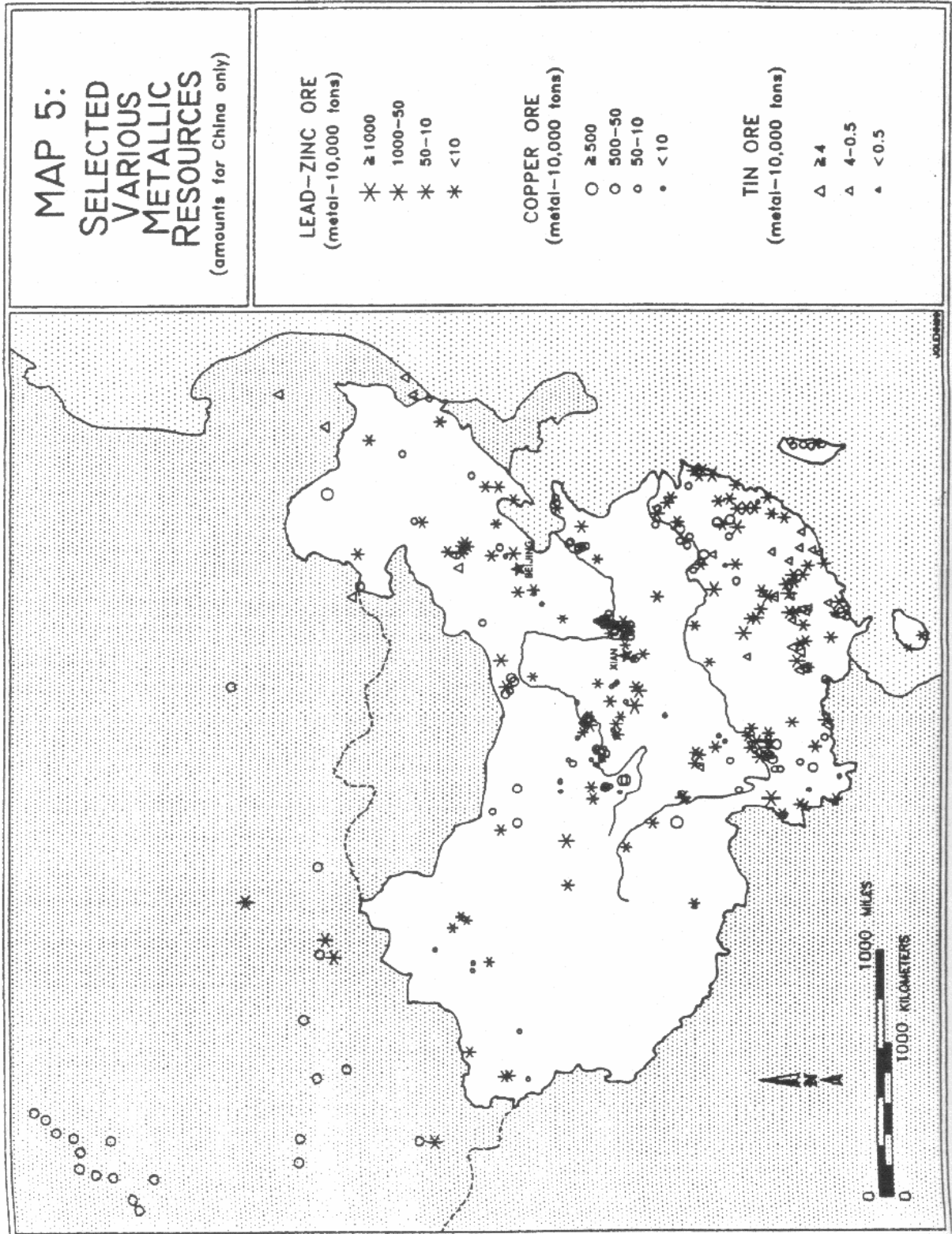
Map 32. The locations of the Afanasievo, Andronovo and Machang cultures in Eurasia. The possible directions of the cultural spread are also shown (after MJJ 2000, 161 Map 6.1).



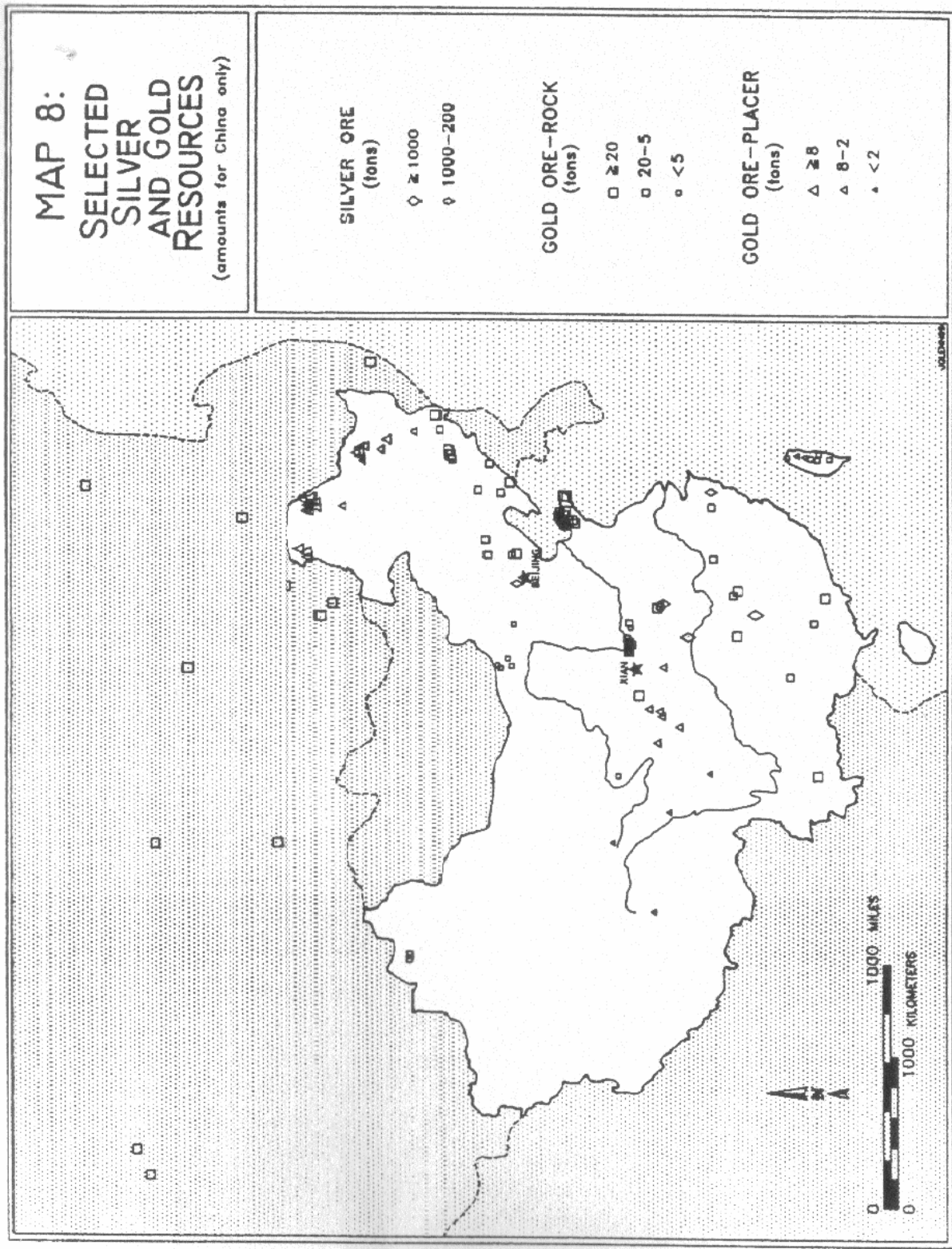
Map 33. Distribution of the Andronovo-related sites found in Xinjiang, 1 Aga'ersen; 2 Lanzhouwanzi; 3 Xintala; 4 Ka'ersang; 5 Urumuchi; 6 Xinyuan; 7 Tacheng; 8 Sazi; 9 Tuoli; 10 Yining; 11 Nieke; 12 Jimusa'er; 13 Qitai; 14 Kuisu; 15 Hami; 16 Wupu; 17 Gumugou; 18 Ke'ermuqiö; Distribution of Bronze Age cultures in Xinjiang: a Gumugou; b Xintala; c Wupu; d Yanbulake; e Nanwan; f Ke'ermuqi; g Haldun; h Aketala (after MJJ 2000, 162 Map 6.3).



Map 34. Early sites yielding metal-by period and type (after Linduff et al. 2000, 273 Map 4).



Map 35. Various metal resources in China (after Linduff et al. 2000, 274 Map 5).



Map 36. Silver and gold resources in China (after Linduff et al. 2000, 277 Map 8).

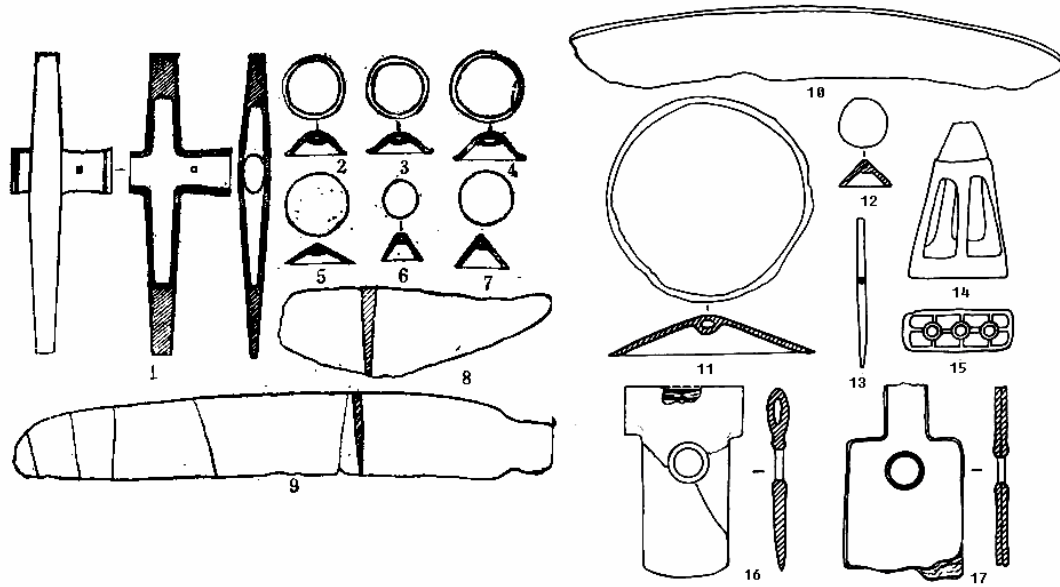


Fig. 001. Shangbanzhuwa, bronze funeral objects, 1 chisel, L 17.8cm; 2-7 bulb, dm 1-2cm; 9.10 knife, L 14.9cm.12.4 cm; 11.12 bulb, dm 5.1cm.1.4cm; 13. awl, L 3.8cm; 14 bell, dm 2.3cm; 15 joined beads, L 2.6cm; 16-17 battle axe, H 9.8cm.10.3cm (after QHY 1996, 36 Fig. 21; QHY 1998, 59 Fig. 22).



Fig. 002. Xiabanzhuwa, bronze funeral objects, 1 knife, L 10.5cm; 2 joined beads, L 1.6-2cm; 3.4 bulb, dm 1.5-3cm; 5.6 earring, 8cm.4.5cm (after Liu/Dou 1998, 8 Fig. 10, 1-5.7).

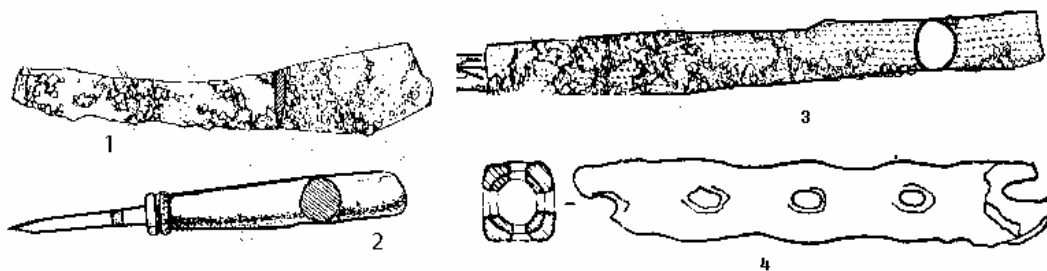


Fig. 003. Gangcha, bronze funeral objects, 1 knife, L 12cm; 2 awl, L 4.4cm; 3 tube, L 9.8cm; 4 tube, L ca.5cm (after Wang W. 1990, 18 Fig. 3, 6-8; Gu W. H. 1990, 69 Fig 3, 1).



Fig. 004. Hongshui, bronze arrowhead, L 2.3cm (after Wu H. X. 1994, 10 Fig. 3, 9).

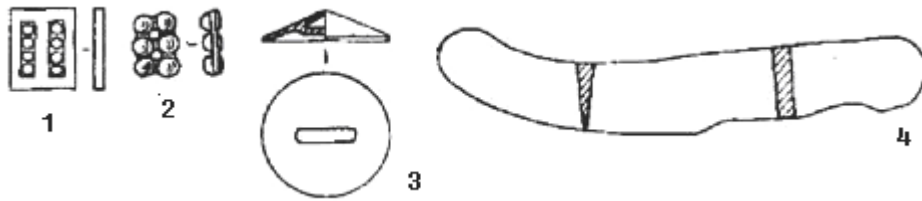


Fig. 005. Shaka, bronze funeral objects, 1,2 joined beads, L 1.8cm.1.3cm; 3 bulb dm 2.6cm; 4 knife, L 10cm (after QHY 2002a, 30 Fig. 30, 3-5. 7).

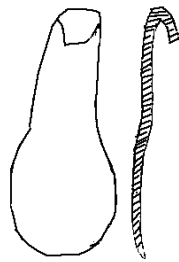


Fig. 006. Shanjiatou, Tomb M4, robe hook, L 7.8cm (after Ge/Hong 1990, 14 Fig. 10, 6).

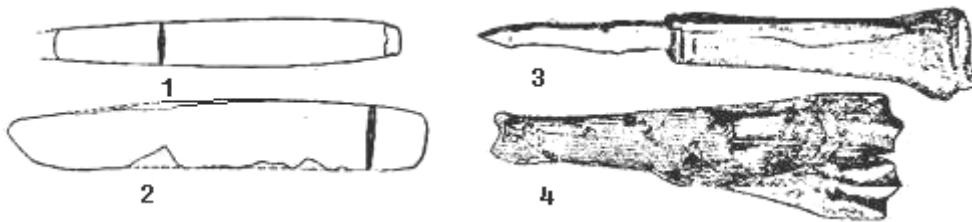


Fig. 007a. Zongzhai, funeral objects, 1-2 bronze knife, L 11.4cm.13.5cm; 3 bone awl, L 6.7cm; 4 bone knife (after QHWD 1986c, 314 Fig. 9, 7.8; 313 Fig. 8, 9).

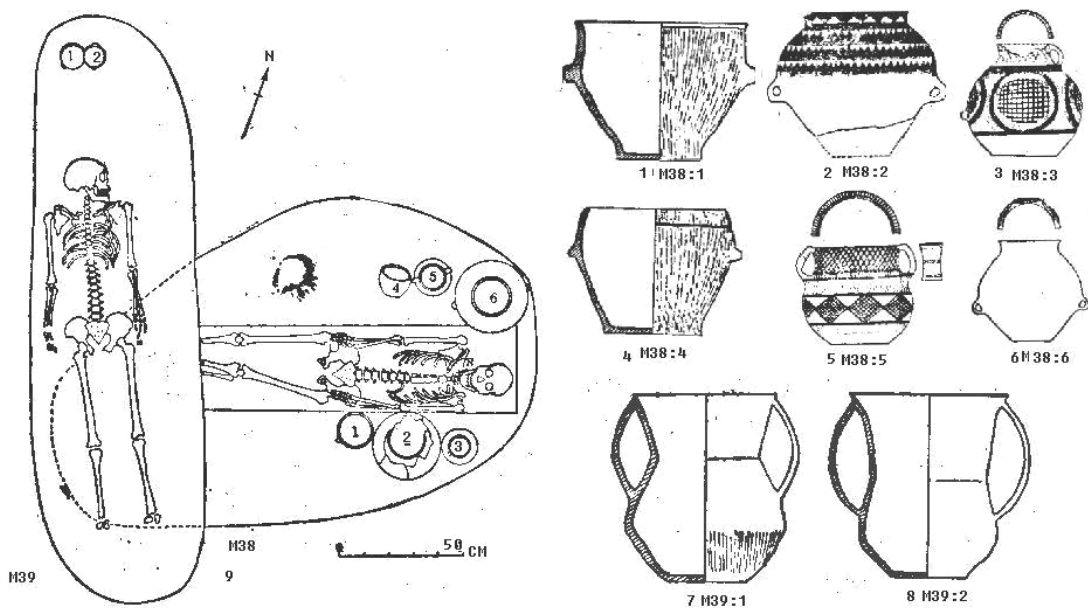


Fig. 007b. Zongzhai, tombs M38 and M39, burial goods (1-8 after QHWD 1986c, 310 Fig. 5, 1; 309 Fig. 4, 12. 2; 310 Fig. 5, 2; 309 Fig. 4, 3.1; 312 Fig. 7, 1.2; 9 adapted from QHWD 1986c, 307 Fig. 3).

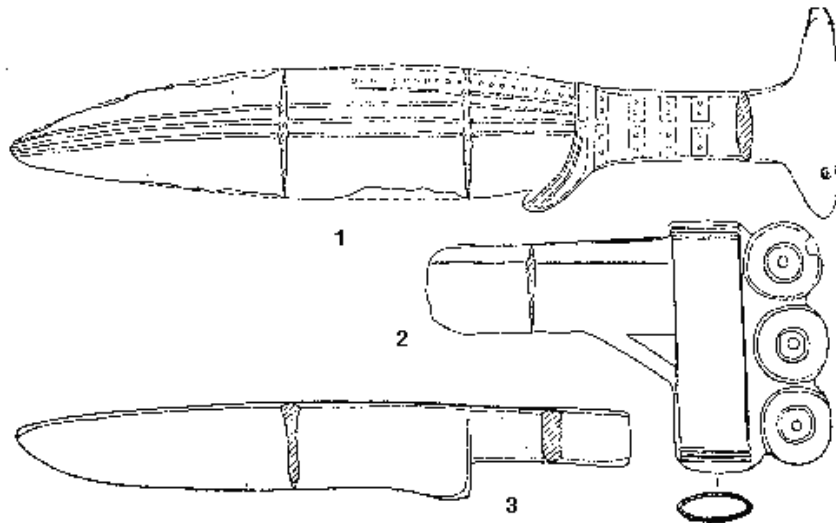


Fig. 008. Zong'an temple, stray finds of bronze artifacts, 1 knife, L 28.5cm; 2 dagger-axe, L 13.5cm; 3 knife, L 21cm (after Gao D. L. 1985b, 49 Fig. 2, 1-3).

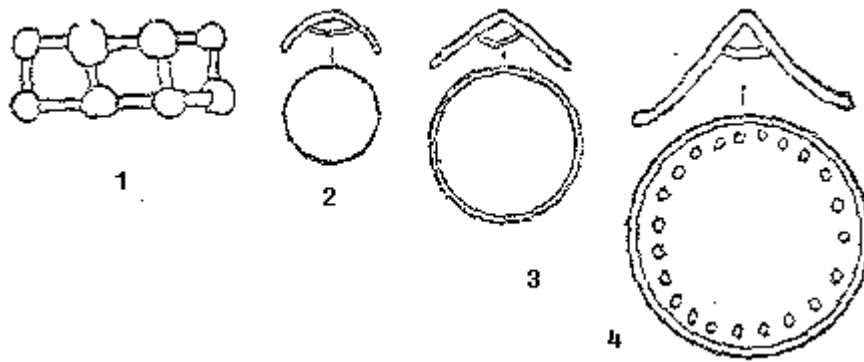


Fig. 009. Suhusa, bronze funeral objects, 1 joined beads, L 2.6cm; 2-4 bulb, dm 1.6cm. 1.9cm. 5.3cm. (after QHK 1994, 460 Fig. 30, 1-4).

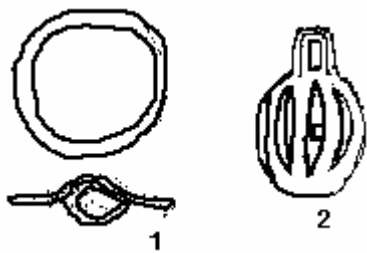


Fig. 010. Chengxi, collected bronze artifacts, 1 bulb, dm 2.15cm; 2 bell, L ca. 2.6cm (after QHY 1990c, 23 Fig. 7, 3.6).

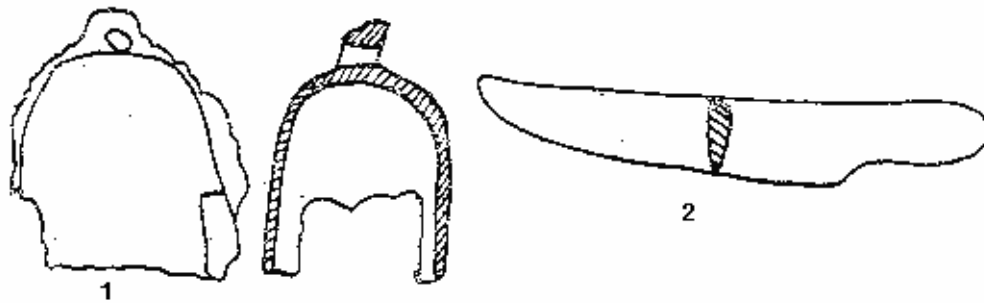


Fig. 011. Shanpingtai, bronze funeral objects, 1 bell, L ca. 2.9cm; 2 knife, L 12cm. (after QHWD et al. 1987, 267 Fig. 22, 12.13).

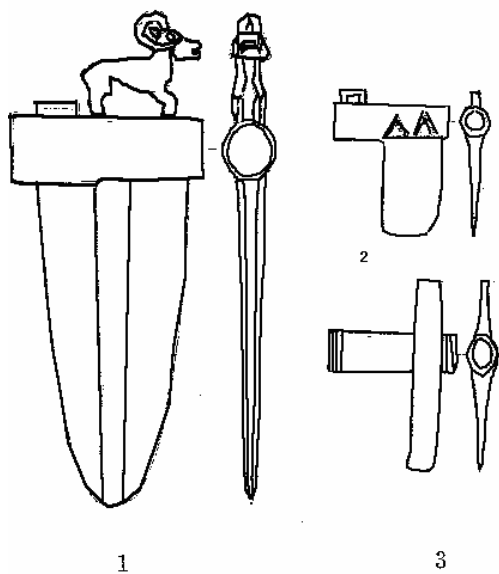


Fig. 012. Liangjiao, collected bronze artifacts, 1 dagger-axe, L 18.5cm; 2 axe, L 7.2cm; 3 cross axe, L 14.2cm (after Liu/Chen 1990, 83 Fig.1).

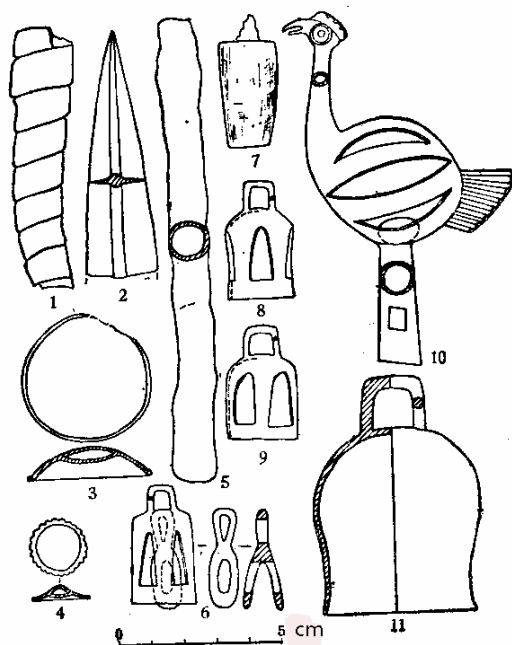


Fig. 013. Huangjiazhai, bronze funeral objects (adapted from QHY et al. 1994, 201 Fig 9).

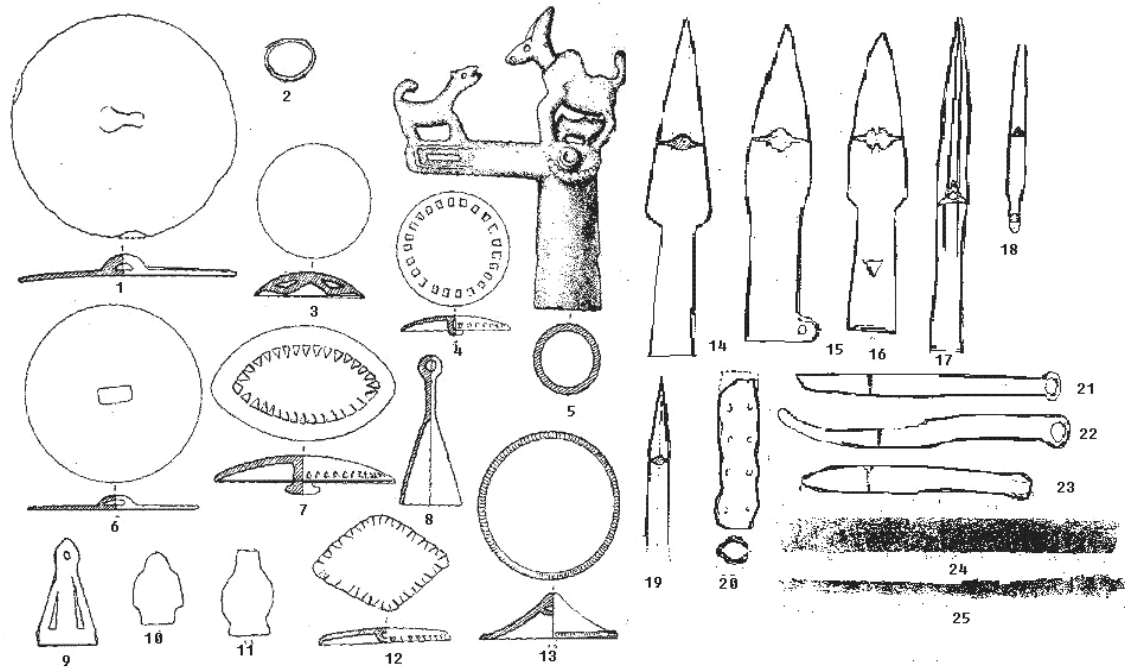


Fig. 014a. Dahuzhongzhuang, bronze funeral objects, 1.6 mirror, dm 10.5cm.9 cm;
 3.4.7.12.13 bulb; 5 pole top, L 12cm; 8-11 bell, dm 1.4-2.5cm; 14-17 spear, L
 25.5cm.23.6cm.22.38cm; 18 arrowhead, L 5.2cm; 19 awl; 21-23 knife, L ca 14.4-16cm (after
 QHHYB et al., 1985, 22 Fig. 22; 20 Fig 16, 1-10; 25 Fig. 25, 5.6).



Fig. 014b. Dahuazhongzhuang, graves (after QHHYB et al. 1985, 14 Fig. 4. Fig. 5; 13 Fig. 3; 15 Fig. 6-8).

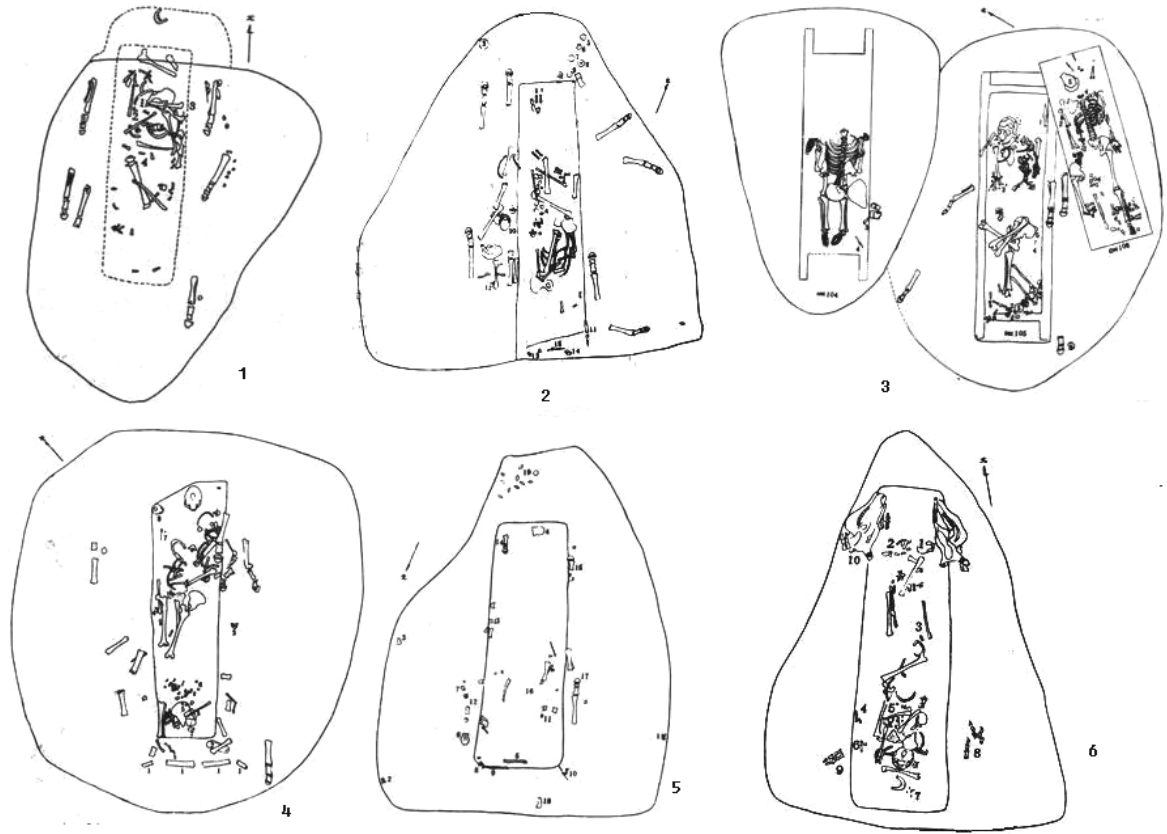


Fig. 014c. Dahuazhongzhuang, graves (after QHHYB et al. 1985, 18 Fig. 14; 17 Fig. 12; 16 Fig. 9-11; 17 Fig. 13).

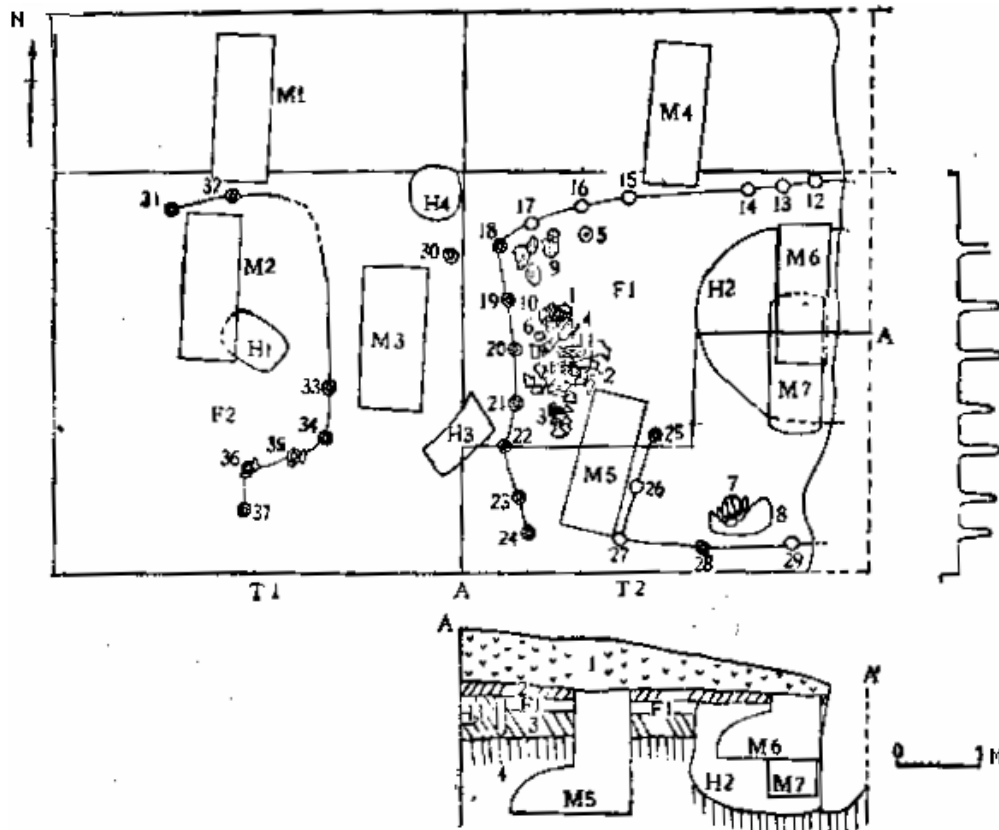


Fig. 015a Mobula, plan of house F1 and F2 (adapted from Gao/Xu 1990, 1013 Fig. 2).

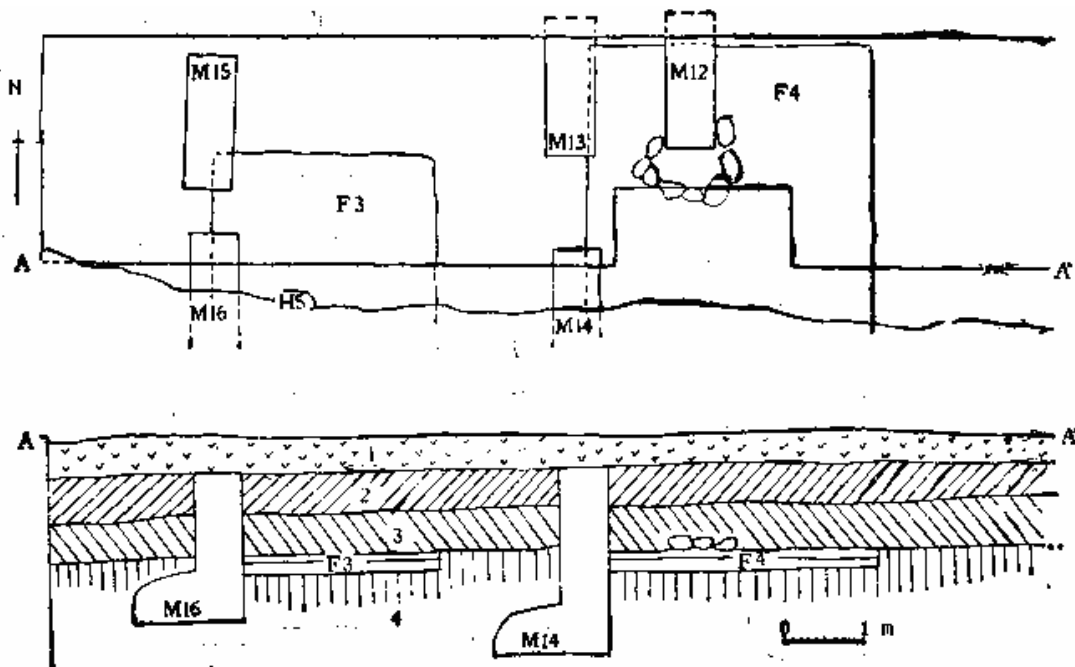


Fig. 015b. Mobula, House F3 and F4 (adapted from Gao/Xu 1990, 1014 Fig. 3).

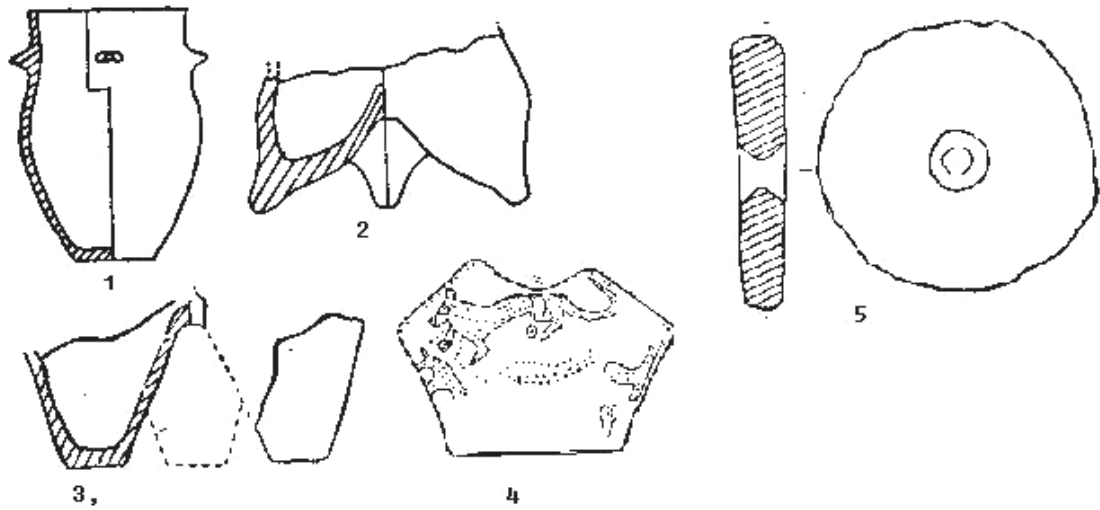


Fig. 015c. Mobula, house F1, 1-3 pottery, L 35.cm.23cm.25cm; 4 bone, L 9cm; 5 stone spiral whorl, dm 7.5cm (after Gao/Xu 1990, 1016 Fig. 6, 3.6.8.9.12).

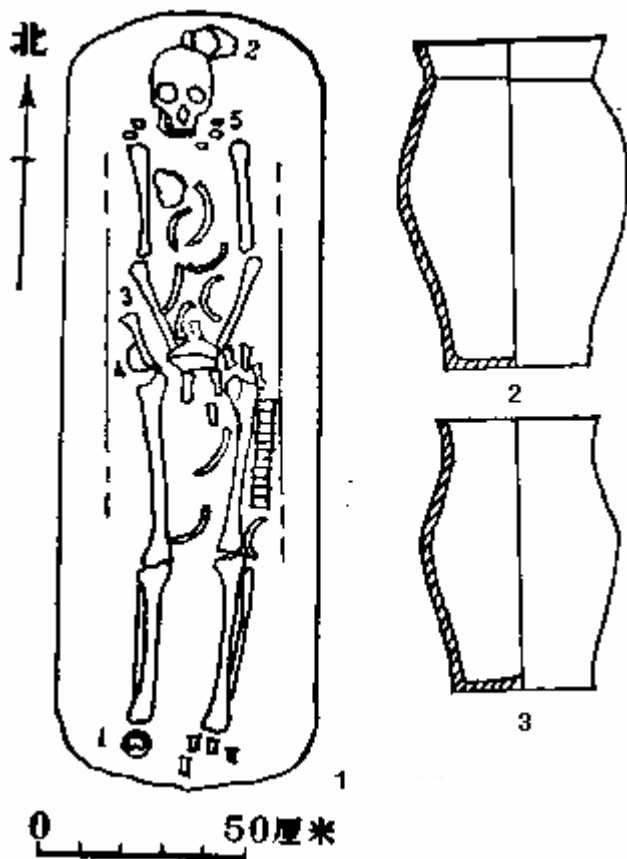


Fig. 015d. Mobula, M7, 2-3 pottery, H 16cm.14cm (after Gao/Xu 1990, 1015 Fig. 5; 1016 Fig. 6, 1.2).

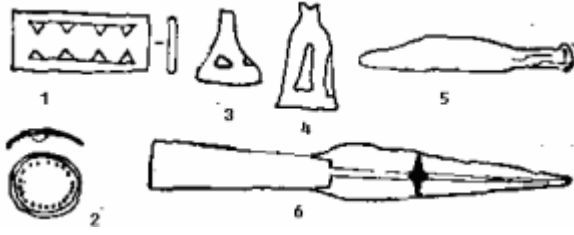


Fig. 016a. Huabiliang and Luanshan, bronze funeral objects (after QHWD et al. 1986b, 886 Fig. 6, 4-9) 1-4 scale 1:2; 5-6 1:4.

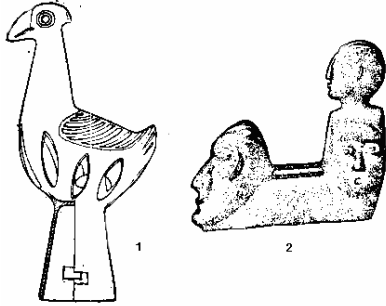


Fig. 016b. Huanyuan county, collected bronze objects, 1 bird, H ca.10.8cm; 2 figure, H ca. 6.6cm (after QHWD et al. 1986b, 883 Fig. 2, 1.11).

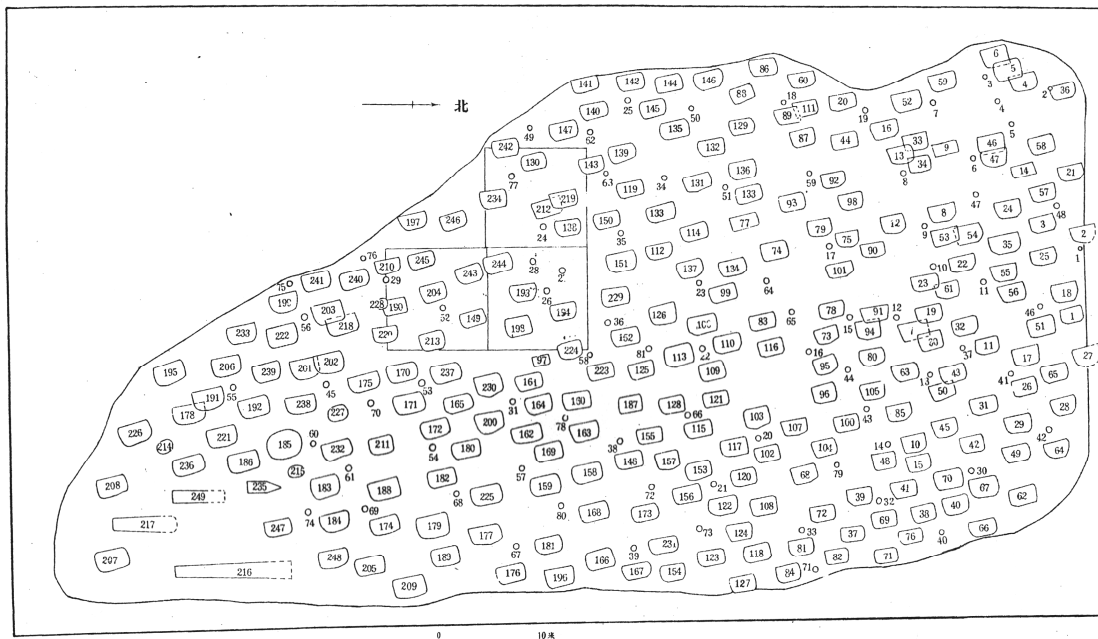


Fig. 017a. Panjialiang, distribution of the tombs (after QHY 1994b, 30 Fig. 2).

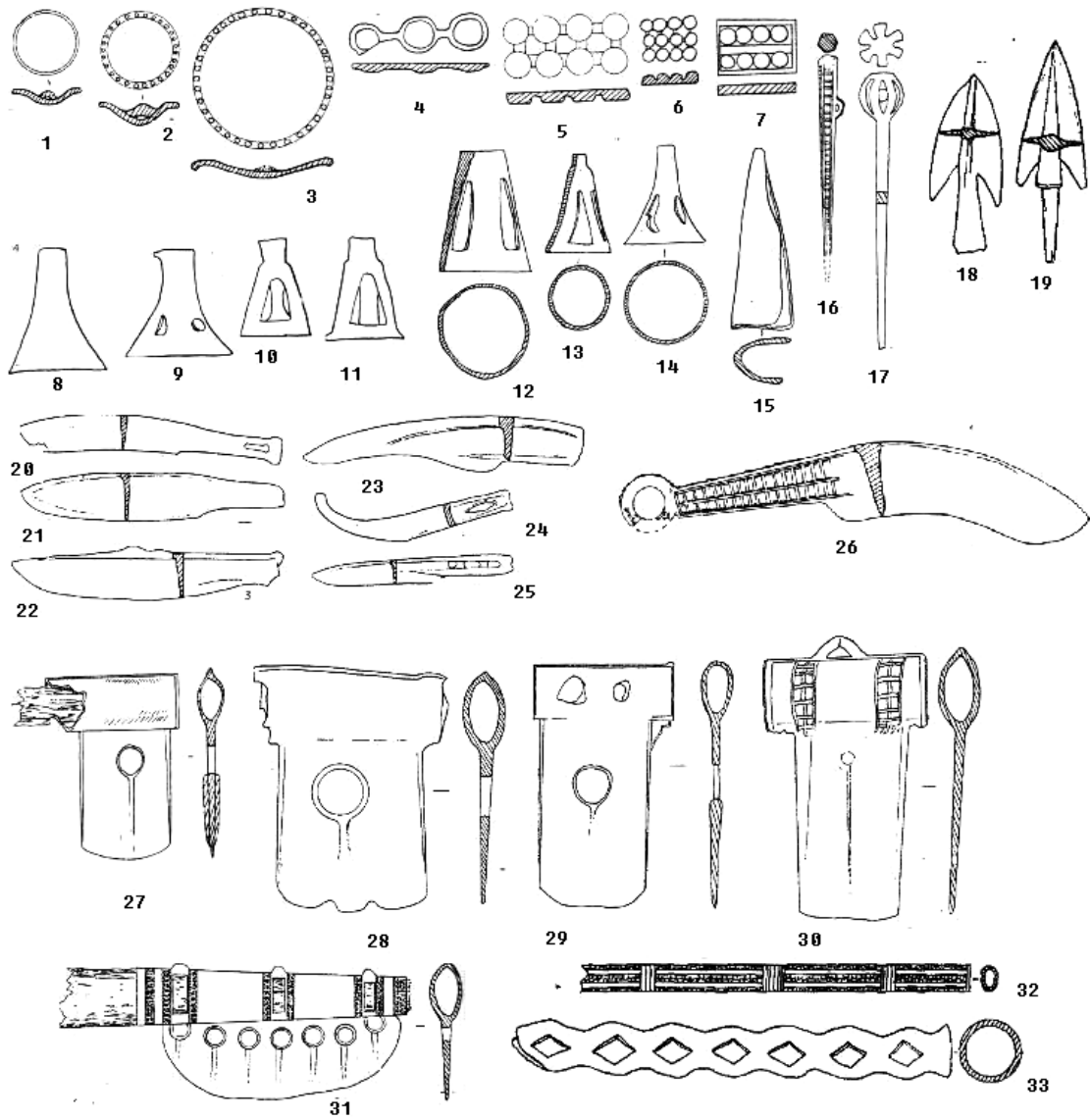


Fig. 017b. Panjialiang, bronze funeral objects (after QHY 1994b, 59 Fig. 35, 4.3.5.8.7.9.10.15.18.16.17.12-14.21.19.20; 57 Fig. 33, 19.20; 58 Fig. 34, 1-3. 8-10; 59 Fig. 35, 1.2; 58 Fig. 34, 5-7.4; 57 Fig. 33, 11.12).

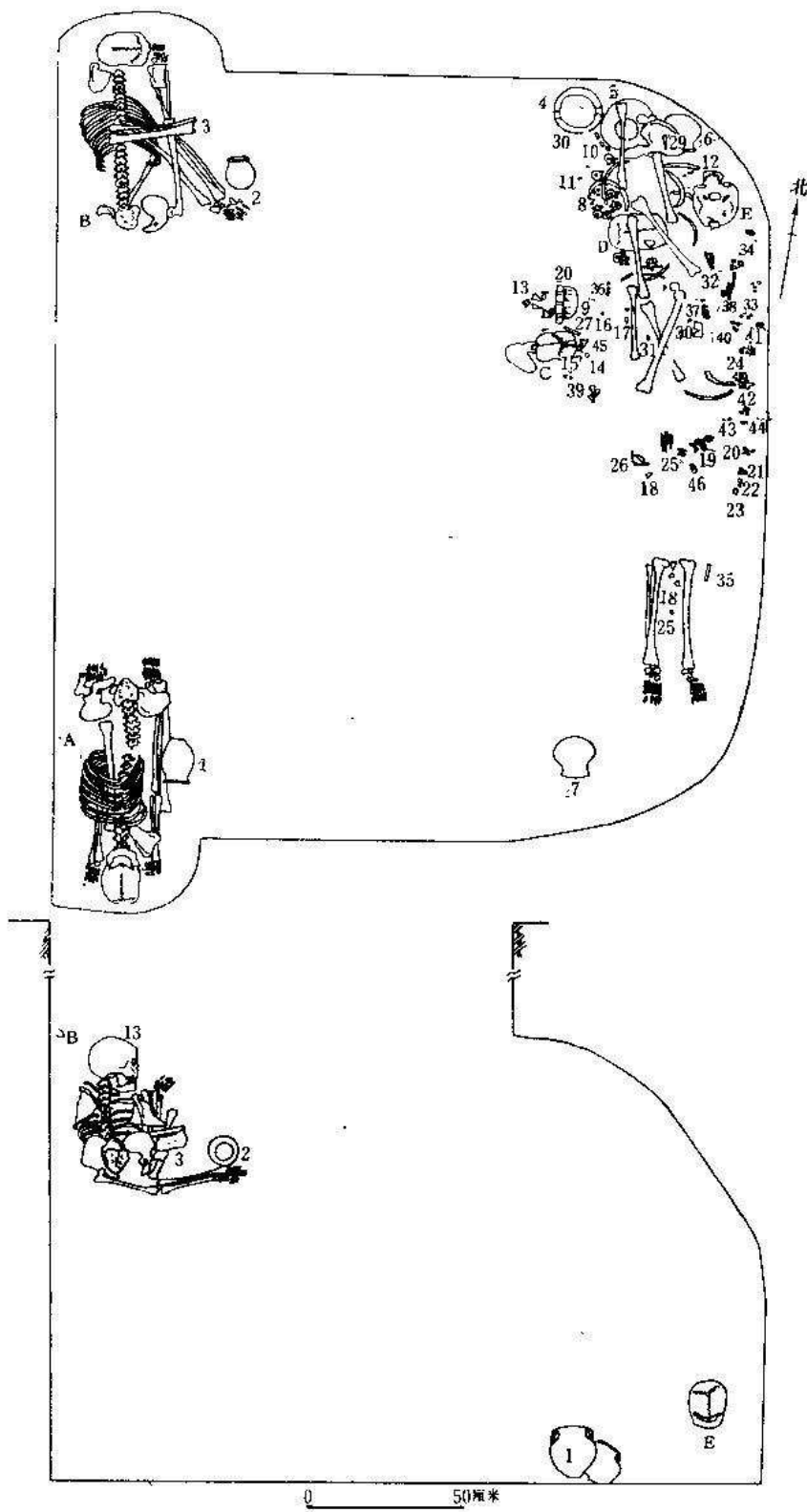


Fig. 017c. Panjiangliang, Tomb 117, A. B the person buried alive; C the bones from others; D. E the owners of the tomb (after QHY 1994b, 48 Fig. 26).

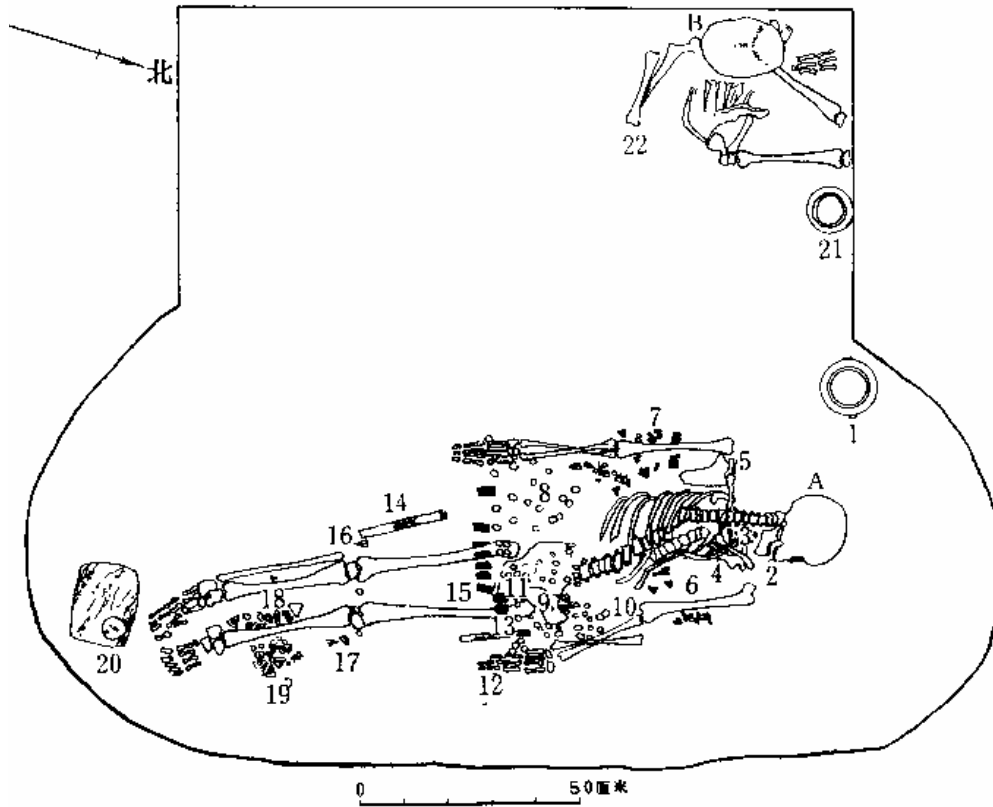


Fig. 017d. Panjialiang, Tomb M210 (after QHY 1994b, 49 Fig. 27).

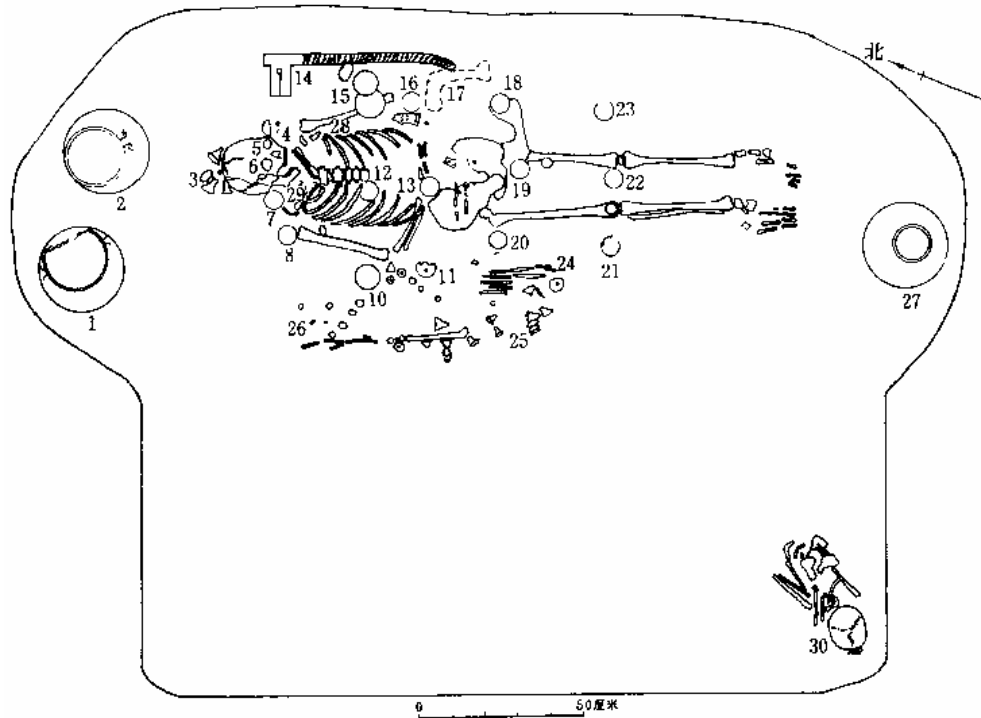


Fig. 017e Panjialiang, tomb M221 (after QHY 1994b, 49 Fig. 28).

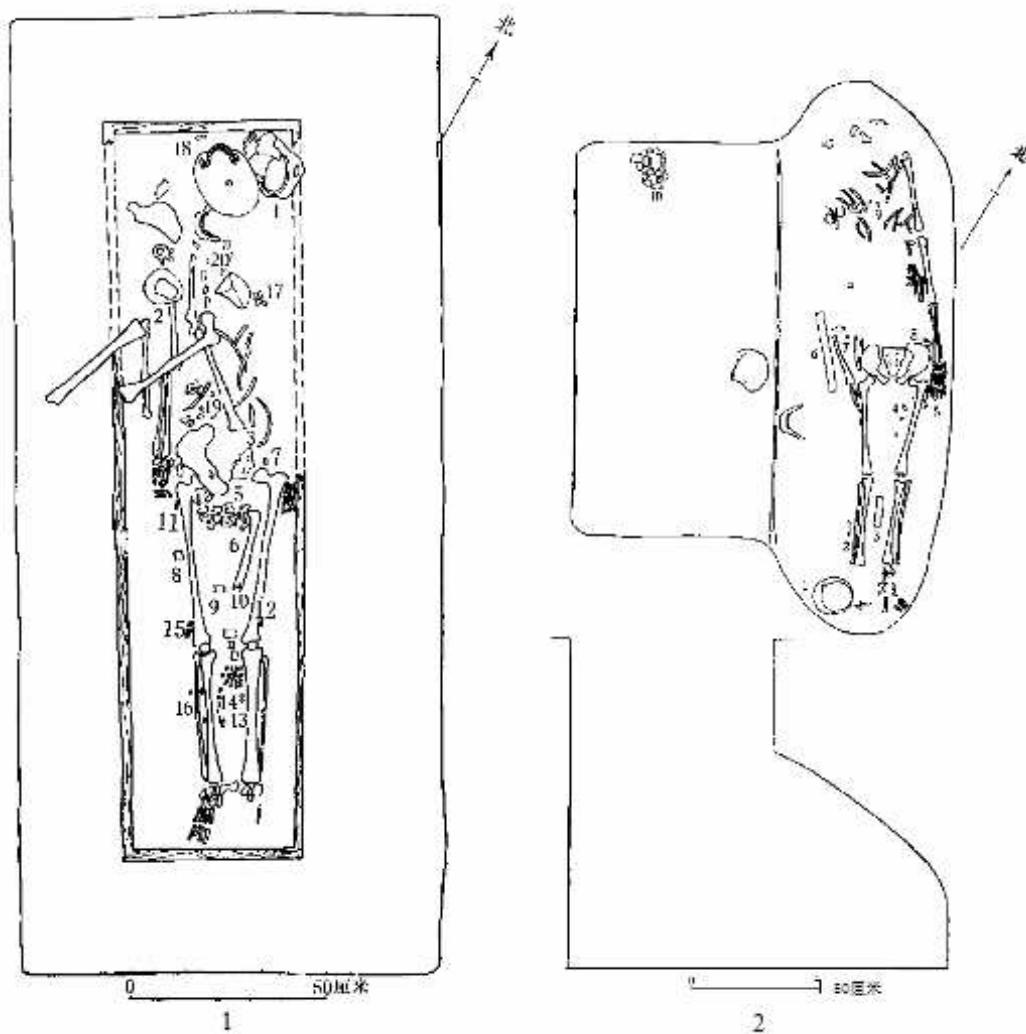


Fig. 017f. Panjialiang, 1 Tomb M144; 2 Tomb M52 (after QHY 1994b, 39 Fig. 12; Fig.13).

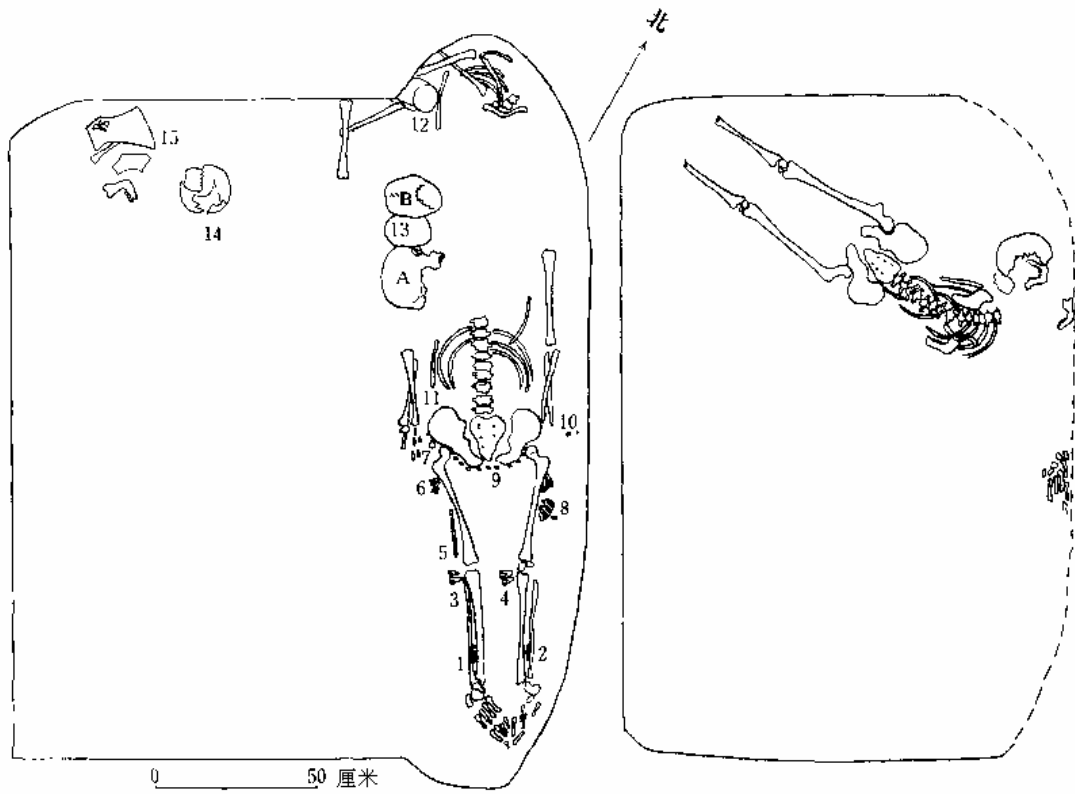


Fig. 017g. Panjialiang, Tomb M150: left, lower tomb; right, upper tomb with the person buried alive (after QHY 1994b, 44 Fig. 18).

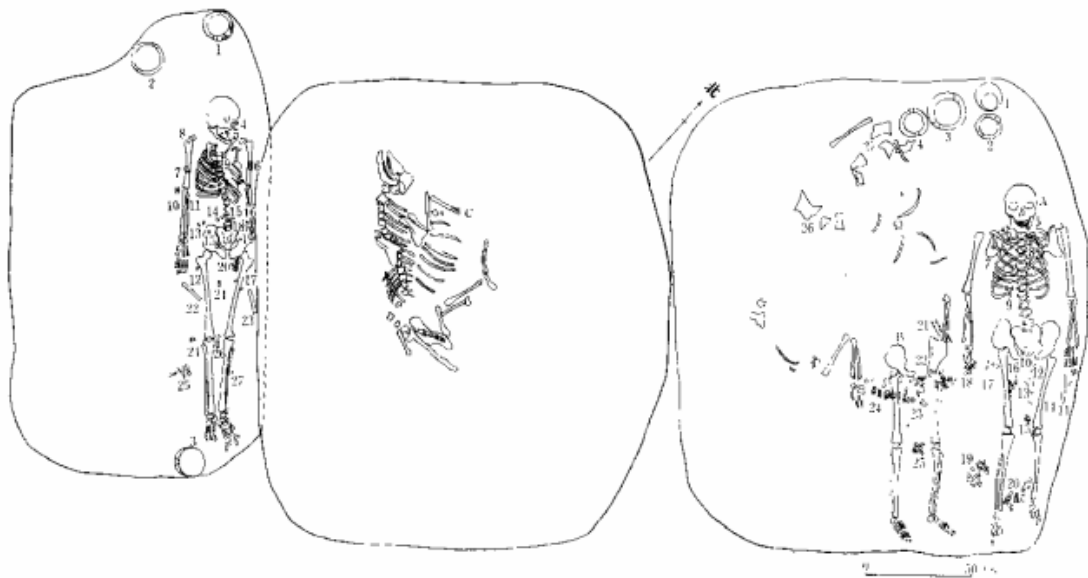


Fig. 017h. Panjialiang, left, tomb M46; right tomb M47 (after QHY 1994b, 40 Fig. 14).

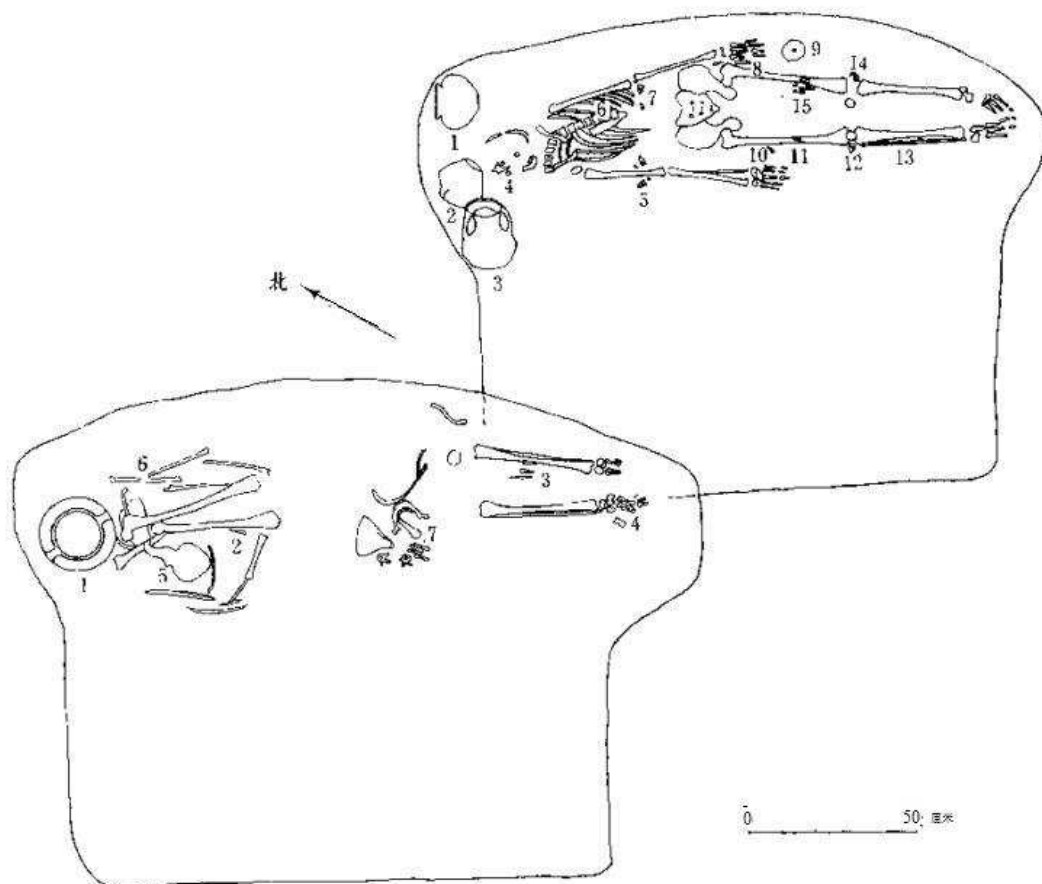


Fig. 017i. Panjialiang, upper, tomb M43; right, tomb M50 (after QHY 1994b, 61 Fig. 36).

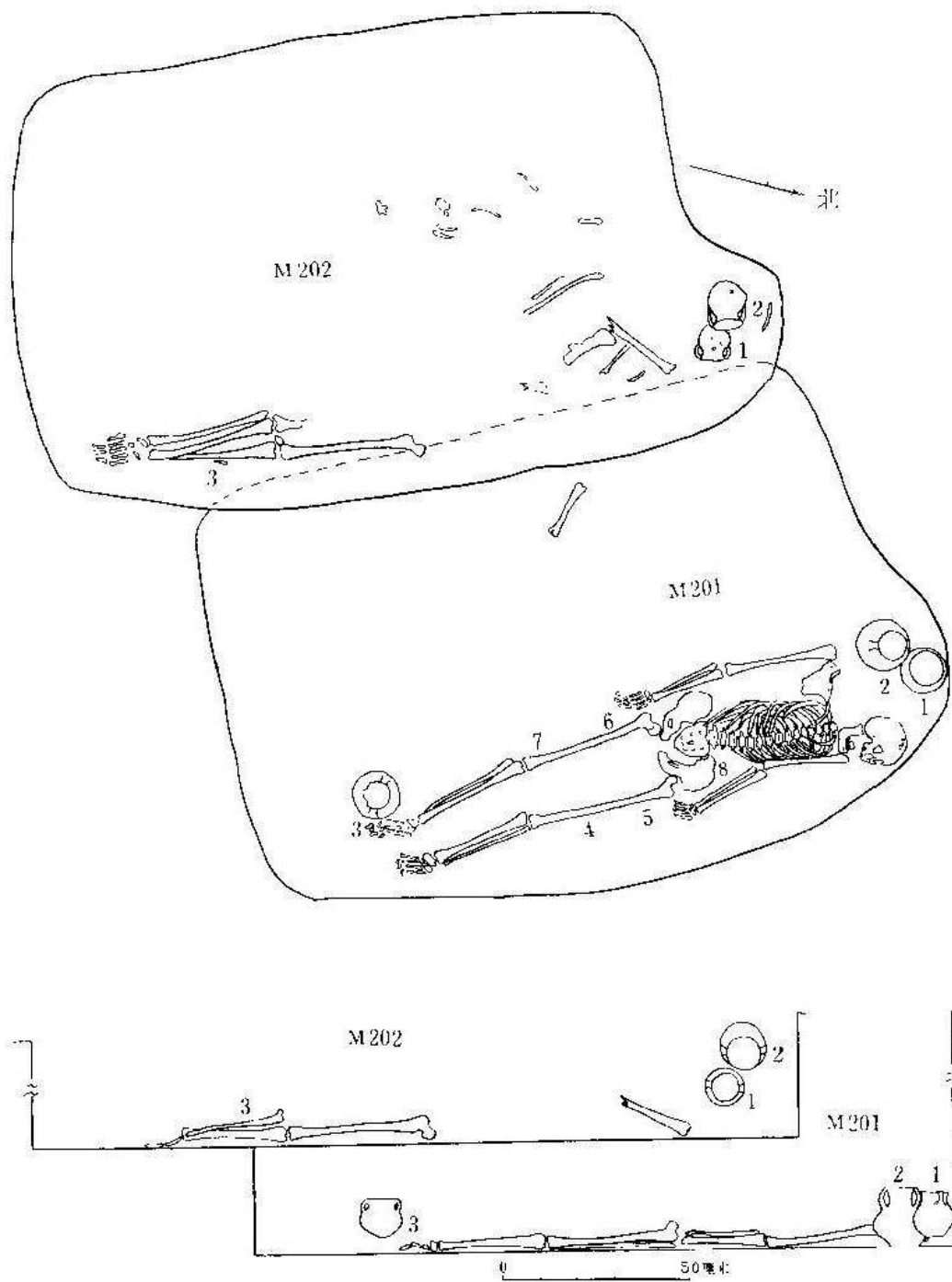


Fig. 017j. Panjialiang, Tomb M202 and Tomb M201 (after QHY 1994b, 62 Fig. 37).

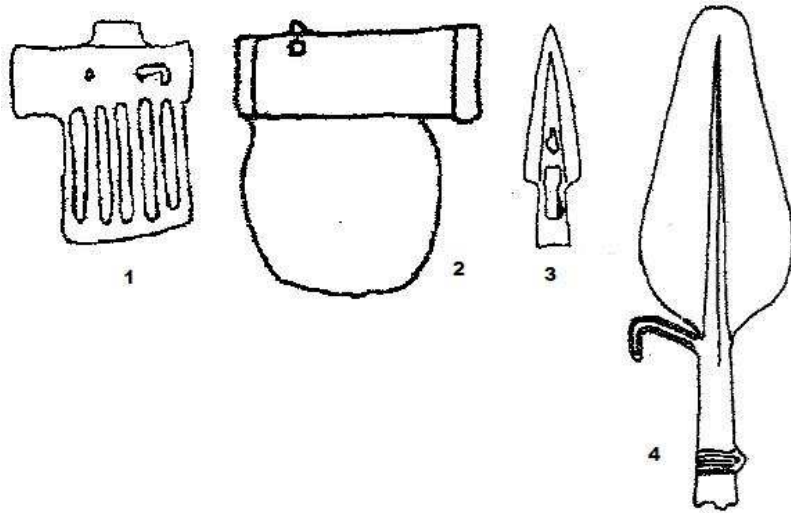


Fig. 018. Collected bronzes, 1-3 found from Huangzhong county; 4 found from Xining, spear, L 61.5 cm (after ZWL 2003, 159 Fig. 4.4, 9.15; 160 Fig. 4.5, 7.5).

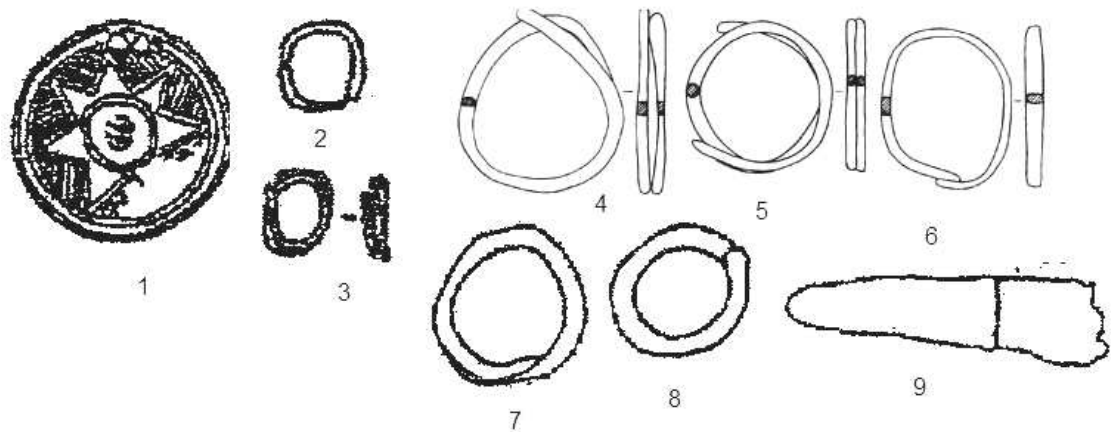


Fig. 019. Bronze objects, 1-3 from Gamatai; 4-9 from Zongri (after Shinian 91; QHW et al. 1998, 14 Fig. 35; ZWL 2003, 158 Fig. 4.2, 7.8.12).

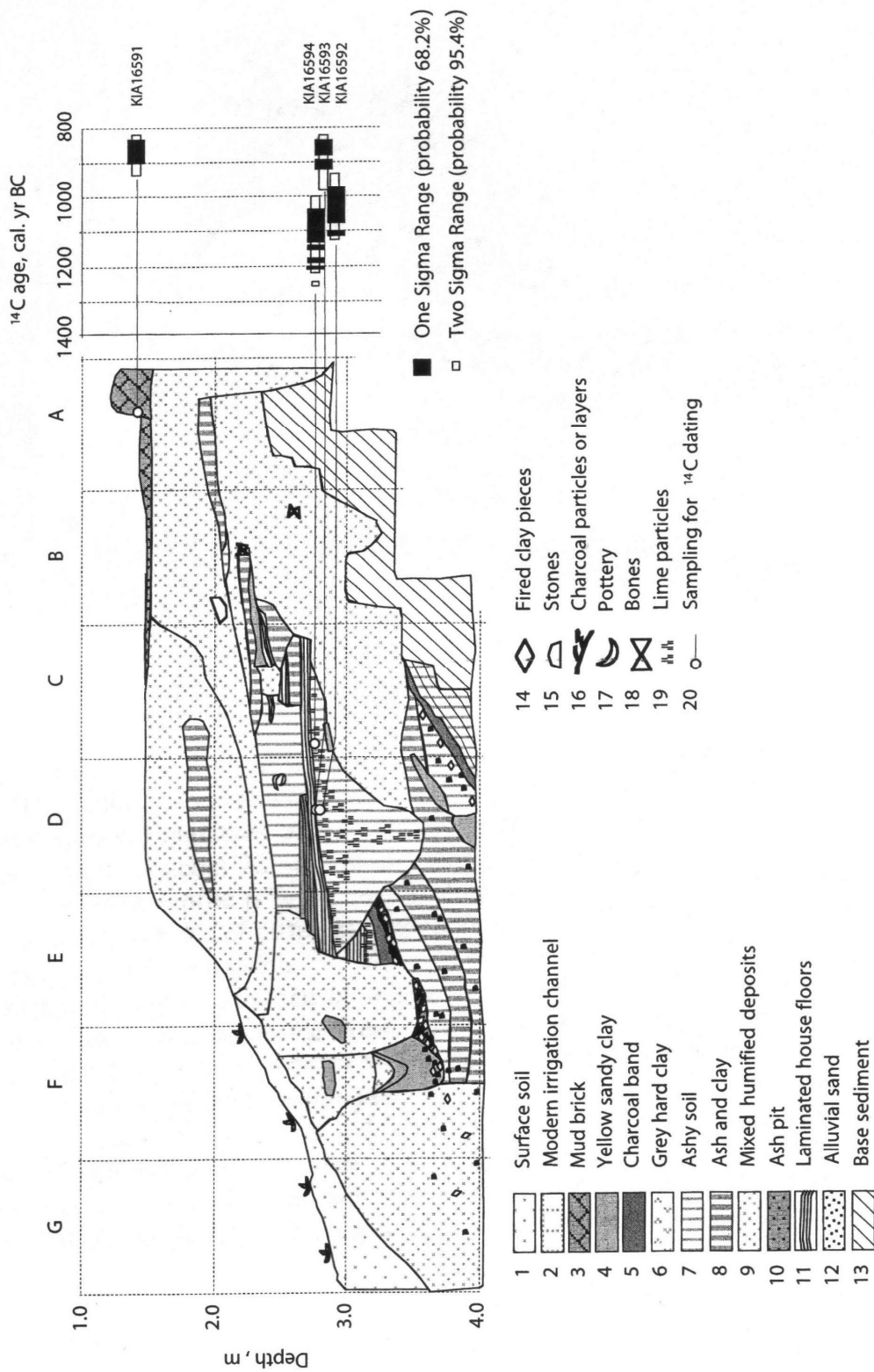


Fig. 020a. Fengtai, trench TG1, West Profile (after Xu, X. G. et al. 2003, 91 Fig. 4).

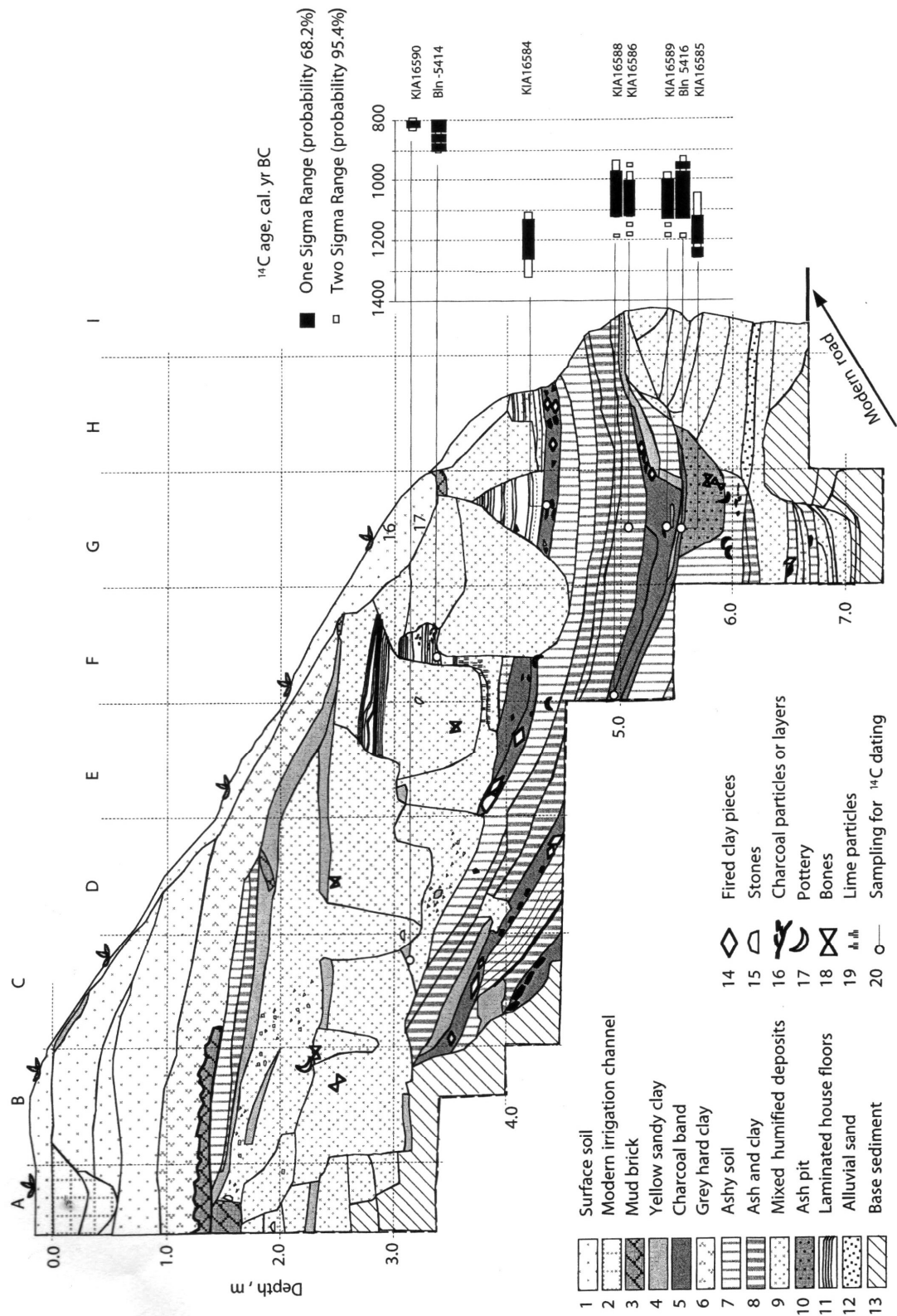


Fig. 020b. Fengtai, trench TG1, East Profile (after Xu. X. G. et al. 2003, 89 Fig. 3)

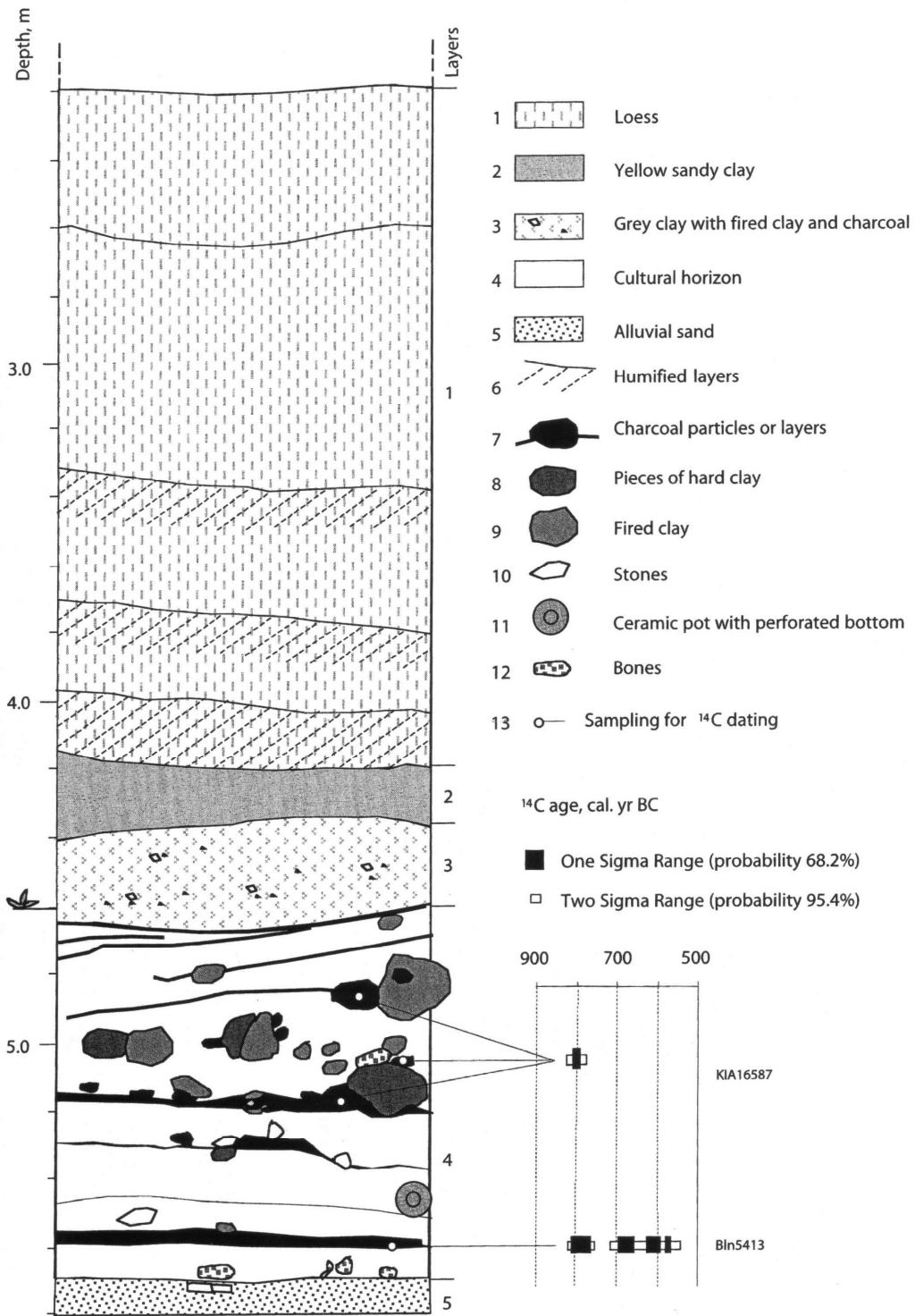


Fig. 020c. Fengtai, trench TG2, South Profile (after Xu X. G. et al. 2003, 95 Fig. 7).

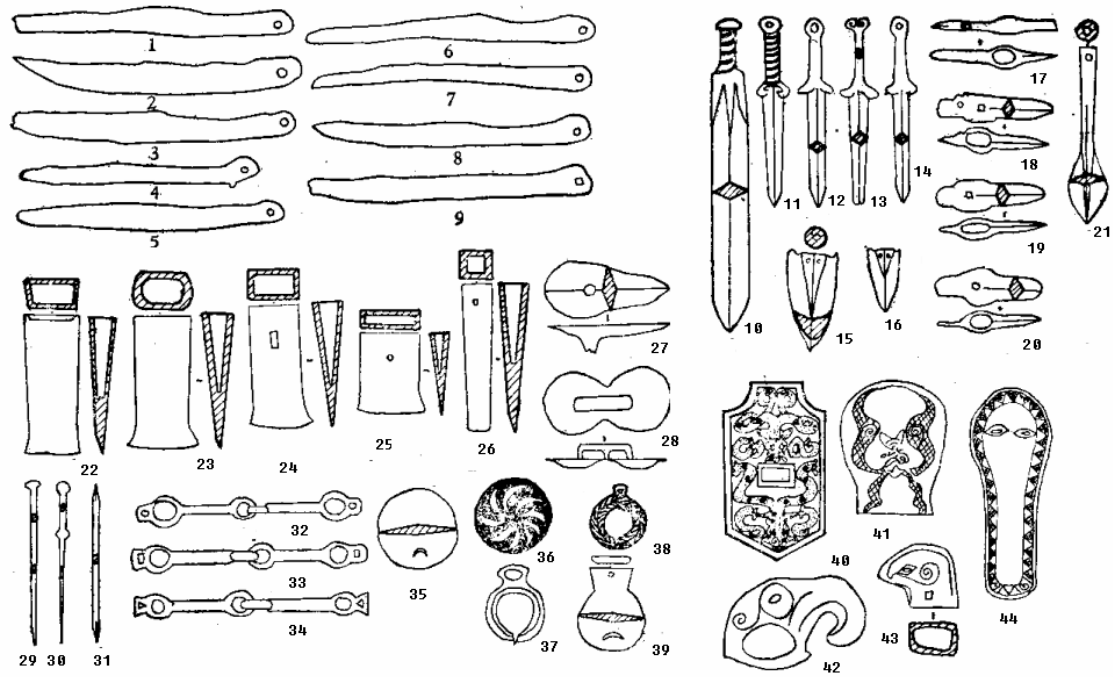


Fig. 021. Langwozikeng, bronze funeral objects, 1-9 knives, L 10.3-18.7cm; 10 iron sword with bronze handle, L 48.7cm; 11-14 short swords, L 25.9cm.29.6cm.25cm.29cm; 15.16 arrowheads, L 5.8cm.3 cm; 17 crane hook, L 16.5cm; 18-20 dagger, L 12.5cm.12cm.11.6 cm; 21 spear, L 15.5cm; 22 adze, L 9.6cm; 23-25 axe, L 19cm.8.3cm.5.2 cm; 26 chisel, L 10.1cm; 27-28 ornaments, L 10.6cm.8.8cm; 29-31 awls, L 11.3cm.10.9cm.16.4cm; 32-34 gag bits, L 20.5-21.5cm (after Zhou X. H. 1989, 973 Fig. 3, 1-9; 974 Fig. 4, 1-5.7.14.9-13; 975 Fig. 5; 976 Fig. 6).

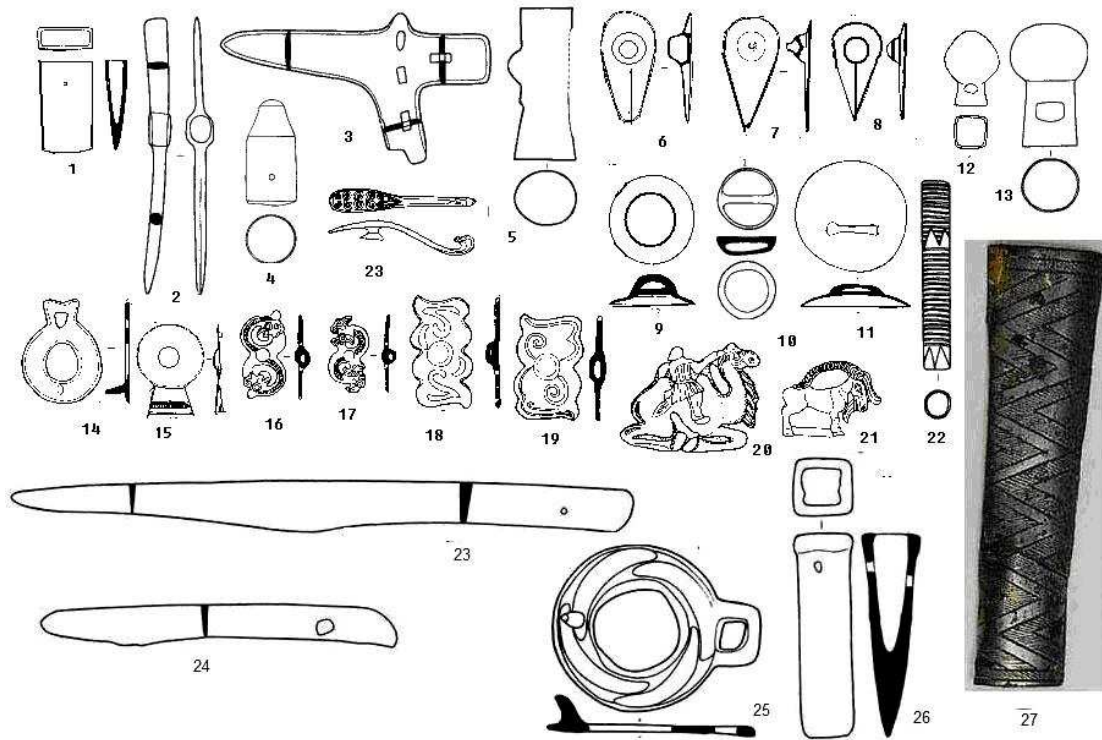


Fig. 022a. Zhangjie, collected bronzes, 1 adze, L 4.2cm; 2 crane hack, L 10.9cm; 3 dagger, L 10.5cm; 4 Dun, L 8.5cm; 5 Yuan-shaft for cart, L 12.1cm; 6-8 Danglu-chriot fitting, L 10.1-9cm; 9-11 bulb, dm 4.1cm.2.3cm.5 cm; 12-13 pole top, H 3.4cm.6.8cm; 14 belt buckle, L 6.7cm; 15 spade plaque, L 8.1cm; 16-19 bird, L 4.1cm.3.5cm.5.3cm.4.8cm; 20-21 buckle, L 6.3cm.4.5cm; 22 tube, L 7.5cm; 23-24 knife, L 17.8,10cm; 25 buckle, L 6.5cm; 26 chisel, L 5.6cm; 27 tube, L 7.5cm (after Yang/Qi 1999, 29 Fig. 1, 11; 30 Fig. 2, 3.4.1.5; 29 Fig. 1, 8.6.16.12; 30 Fig. 2, 2; 29 Fig. 1, 9.4; 30 Fig. 2, 6; 29 Fig. 1, 13.15.7.10.1.15.14; 30 Fig. 2, 7; NXI et al. 2002, 19 Fig. 7, 2.3; 20 Fig. 10, 4; 19 Fig. 7, 7; Plate 2, 2).

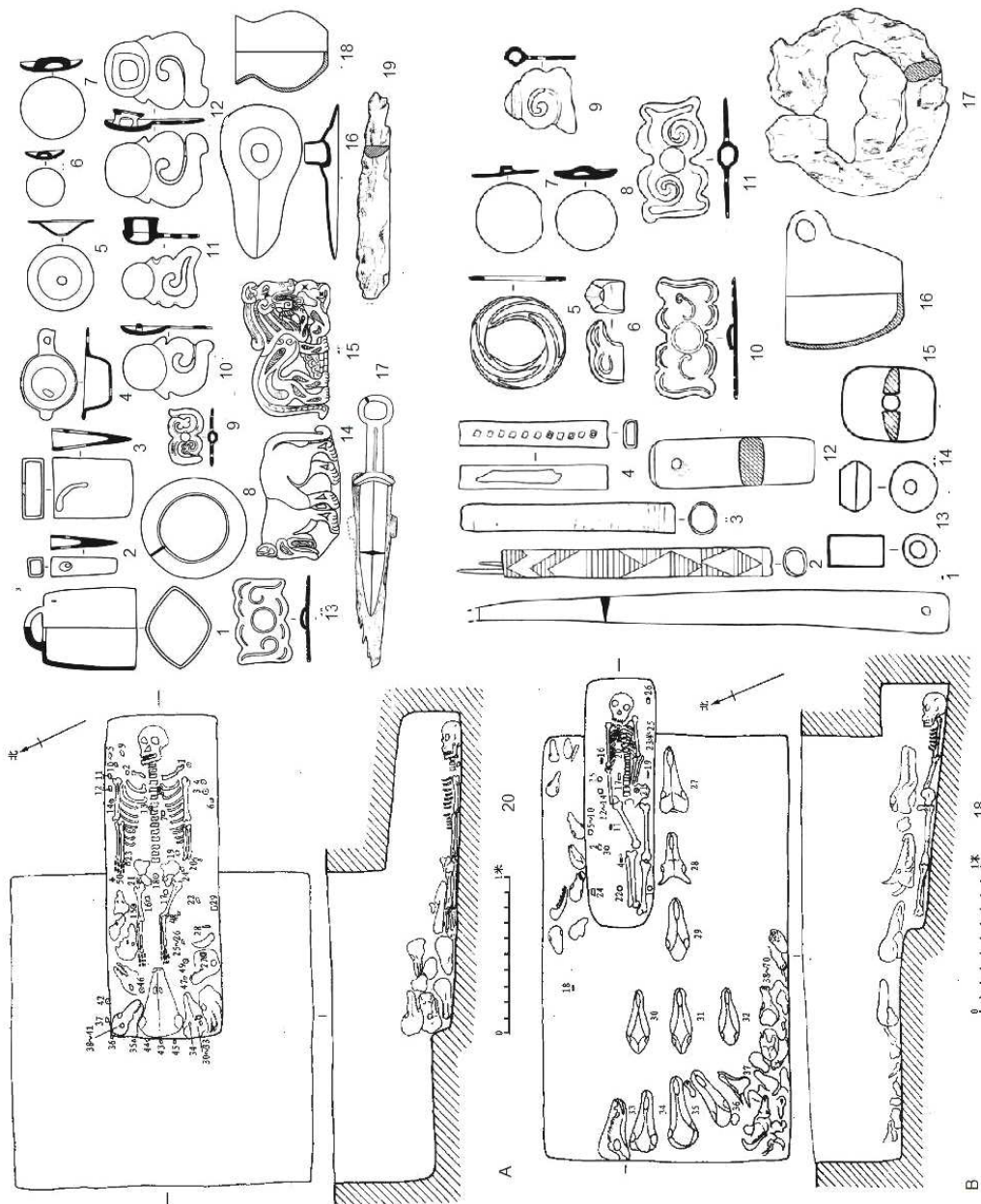


Fig. 022b. Zhangjie, tombs and funeral objects, A. 1-19 funeral objects, 20 Tomb M2; B. 1-17 funeral objects, 18 Tomb M3 A: 1-17 bronzes; 18 pottery; 19 iron; 1 bell, H 6.3cm; 2 chisel, L 3.7cm; 3 axe, L 4.5cm; 4 vessel, H 1.6cm; 5-7 bulb, dm 4.2cm.2.5cm.4cm; 8 loop, dm 6.4cm; 9-12 bird, L 2.8cm.5cm.4.4cm.5.7cm; 13 belt ornament, L 4.5cm; 14-15 plaque, L 6.8cm.7.5cm; 16 Danglu, L 9.7cm; 17 sword, L 25.4cm; 18 pottery, H 4.5cm; 19 sword, L 12.9cm; B. 1-11 bronze; 12 gravel; 13-15 agate; 16 pottery; 17 iron; 1 knife, L 19cm; 2-4 tube, L 11.5cm.9.2cm.6.3cm; 5 loop, dm 4.3cm; 6 polo hop, H 1.5cm; 7-8 bulb, dm 3.2cm.2.8cm; 9-11 plaque, L 3-4.7cm; 12 gravel, L 7.6cm; 13-15 agate, L 1.3cm.1.2cm.2.1cm; 16 pottery, H 11.5cm; 17 iron loop, dm 8.5cm (A after NXI et al. 2002, 19 Fig. 7, 4.6.11; 20 Fig. 10, 1.2.10.16.5; 21 Fig. 11, 3.4.7.1.6.5.10; 20 Fig. 10, 3; 19 Fig. 7, 9; 20 Fig. 10, 14.12; 16 Fig. 3; B after NXI et al. 2002, 19 Fig. 7, 1.8.12.10; 20 Fig. 10, 4; 19 Fig. 7, 5; 20 Fig. 10, 9.15; 21 Fig. 11, 2.6.8; 20 Fig. 10, 7; 22 Fig. 12, 2.3.15; 20 Fig. 10, 13.17; 17 Fig. 4).

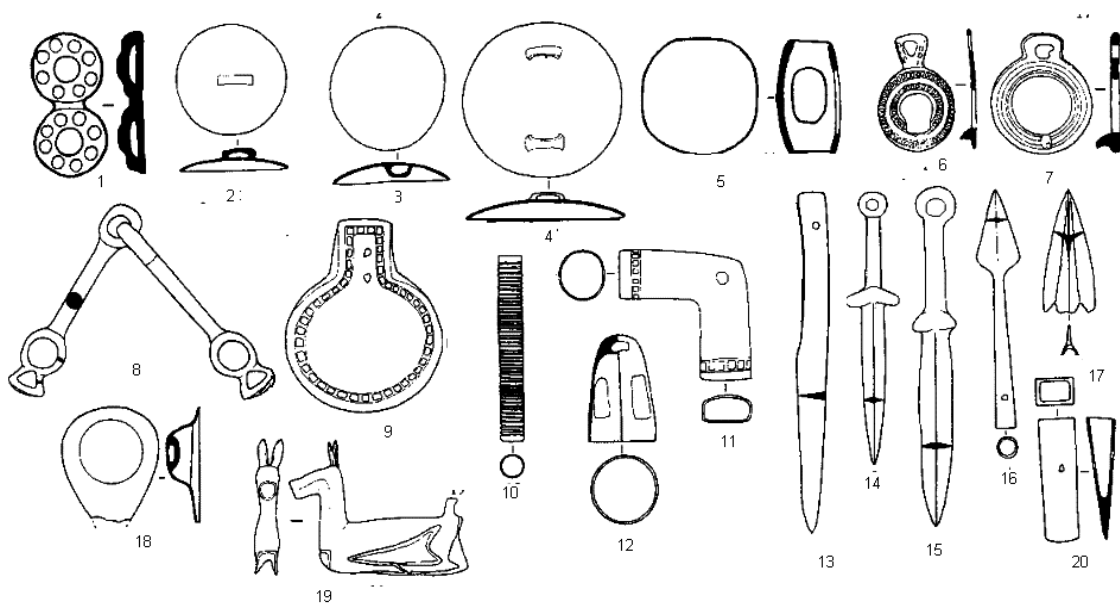


Fig. 023. Miyuan, bronze objects, 1-4 bulb, dm 3.6-7.8cm; 5 Jieyue, dm 2.8cm; 6,7 buckle, L 5.9cm.6cm; 8 gag bit L 20.5cm; 9 plaque, L 9.7cm; 10,11 tube, L 9.5cm.6cm;12 bell, H 5.4cm; 13 knife, L16.8cm; 14,15 sword, L 27.6, 15cm; 16 spear L 24cm; 17 arrowhead, L 6.3cm; 18 Danglu, L 5.8cm; 19 figure, L 8.9cm; 20 adze, L 12.4cm (after Yang/Qi 1999, 31 Fig. 3, 1.2.3.13.15.17.18.6.9.19.16.7.5.8.14.10.11..4.20.12).

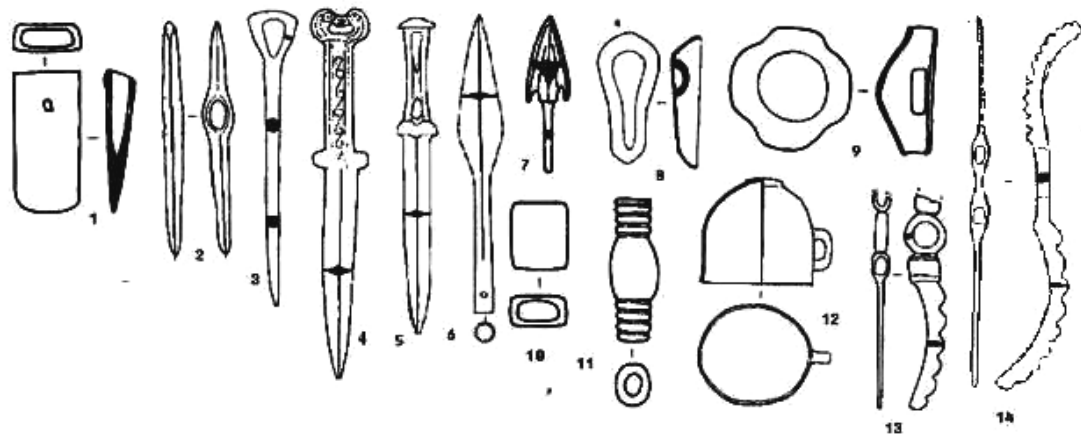


Fig. 024. Xianma, bronze objects, 1 adze, L 3cm; 2 crane hack, L 10cm; 3 awl, L 12cm; 4-5 short sword, L 25.6cm.17cm; 6 spear, L 15.8cm; 7 arrowhead, L 3.3cm; 8 Danglu, L 5.6cm; 9 Jieyue, dm 2.7cm; 10-11 tube, L 1.4cm.3cm;12 axle, dm 4.4cm; 13-14 horse bit, L 9.1cm.15cm (after Yang/Qi 1999, 33 Fig. 4, 6.2.13.14.1.3.4.5.8.7.12.10.13.11).

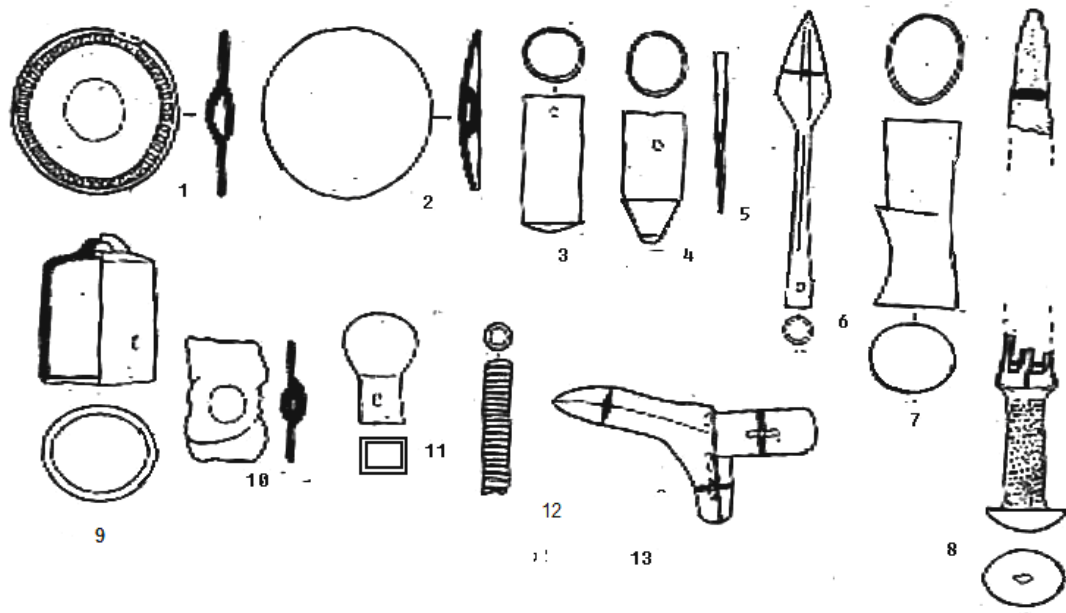


Fig. 025. Guantai, bronze objects, 1-2 plaque, dm 10.6cm.4.5-8.1cm; 3-4 Dun, H 9.6cm.9.2cm; 5 awl, H 5.7cm; 6 spear, L 2.6cm; 7 axle ornament, H 12.4cm; 8 sword, L 50cm; 9 bell, H 5.4cm; 10 plaque, L 4.3cm; 11 pole top, L 3.9cm; 12 tube, H 2.5-5.5cm; 13 dagger, L 18.4cm (after Luo/Yan 1993, 18 Fig.1, 1.2.6.10.7.13.14.9.8.13.11.5).

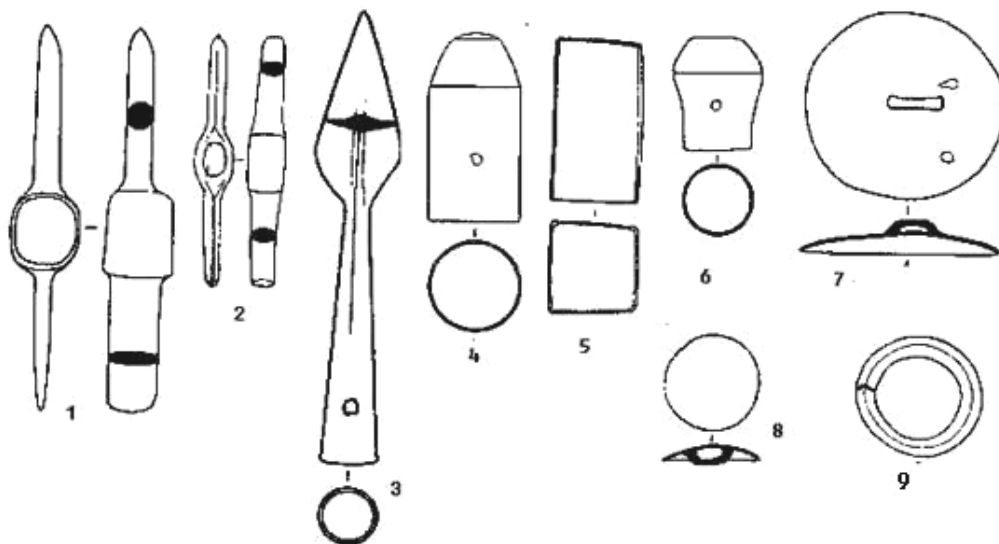


Fig. 026. Baicaowa, bronze objects, 1-2 crane hack, L 14cm.9.1cm; 3 spear, L 16.4cm; 4 Dun, L 6.8cm; 5 Yuan-shaft of the cart, L 5.8cm; 6 pole top, H 4.1cm; 7-8 bulb, dm 7cm.2cm; 9 loop, dm 4.5cm (after Yang/Qi 1999, 34 Fig. 5, 8.1.7.5.6.3.4.2.9).

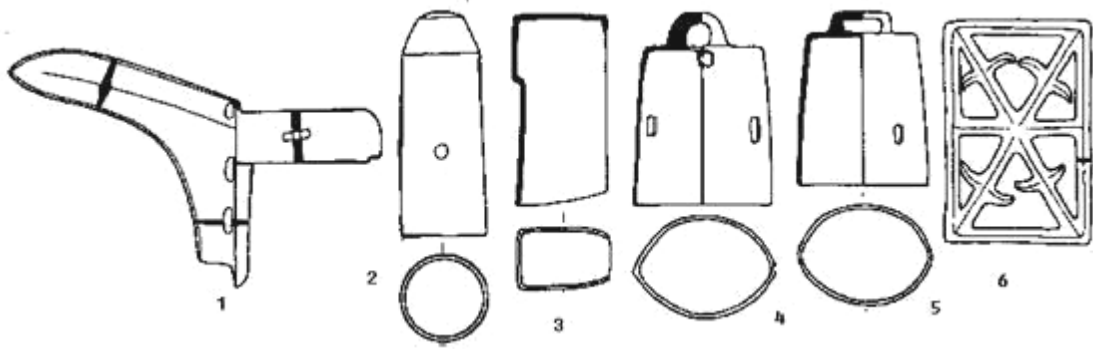


Fig. 027. Baicha, bronze objects, 1 dagger, L 12cm; 2 Dun, L 11.7cm; 3 Yuan-Shaft of a cart, L 10cm; 4-5 bell, H 10.9cm; 6 plaque, L 11.7cm (after Yang/Qi 1999, 34 Fig. 6, 6.2.4.1.5.3.).

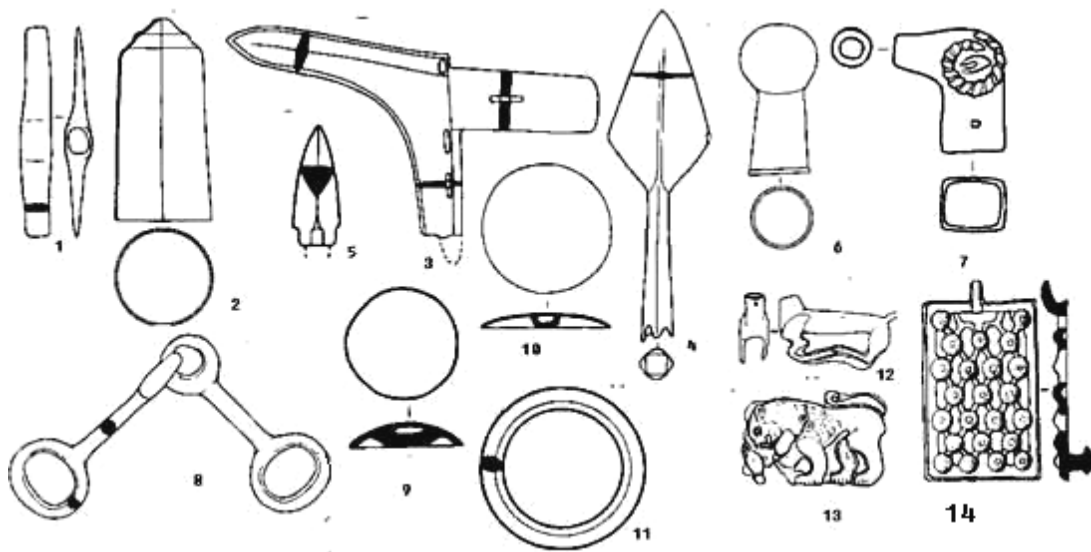


Fig. 028. Dianwa, bronze objects, 1 crane hack, L 10.5cm; 2 Dun, L 10cm; 3 dagger, L 10.8cm; 4 spear, L 16.4cm; 5 arrowhead, L 3cm; 6-7 pole top, L 7.4cm.3cm; 8 gag bit, L 20cm; 9-10 bulb, dm 2.8cm.6.2cm; 11 loop, dm 4cm; 12-13 figure, L 6cm. 6.9 cm; 14 belt buckle, L 10cm (after Yang/Qi 1999, 36 Fig. 7, 8.2. 6.11.12.7.13.4.3.11.10.9.15).

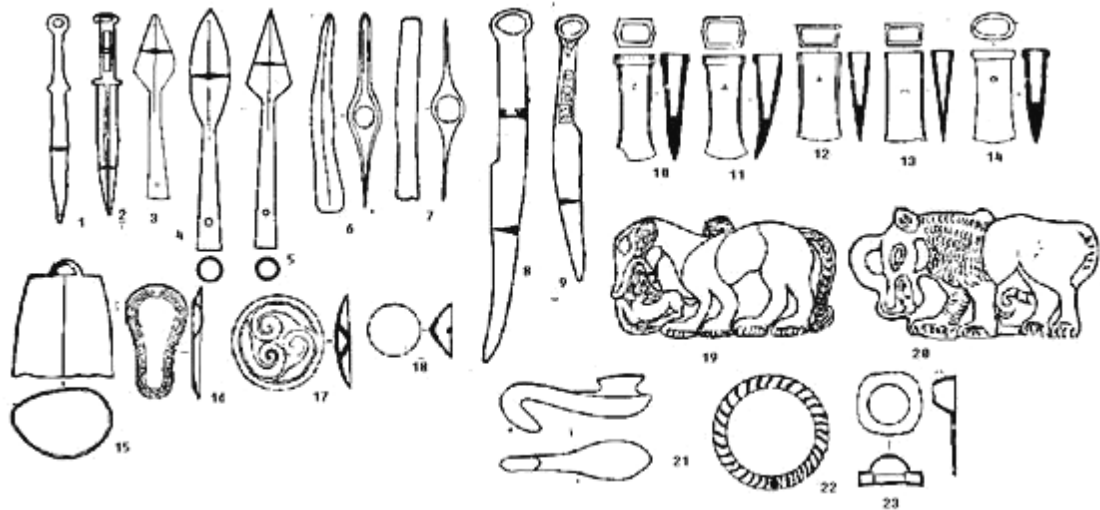


Fig. 029. Pengyang county, bronze objects, 1-3 from Zhengzhuang, L 19.5cm.7.7cm.12.6cm; 4.19.22 from Baiyanglin, L 22.8cm.8cm.; 5 from Miyuan, L 22.8cm; 6.7.9-11.21 from Gucheng, L 15.6cm.14.5cm.15.6-17.4cm.9.3-11.6cm.5-10cm; 8.12-18 from Mengyuan, L 7.9-22.4cm; 20 from Yaohe, L 9cm (after Luo/Han 1990, 404 Fig. 1, 2.5; 405 Fig. 2, 5.6.; 406 Fig. 3. 2.3; 407 Fig. 5, 3.11; 408 Fig. 7, 8.9.1.2.5; 409 Fig. 8, 10; 411 Fig. 10, 9; 412 Fig. 11, 2.5; 413 Fig. 12, 1.2; 415 Fig. 14, 7.13).

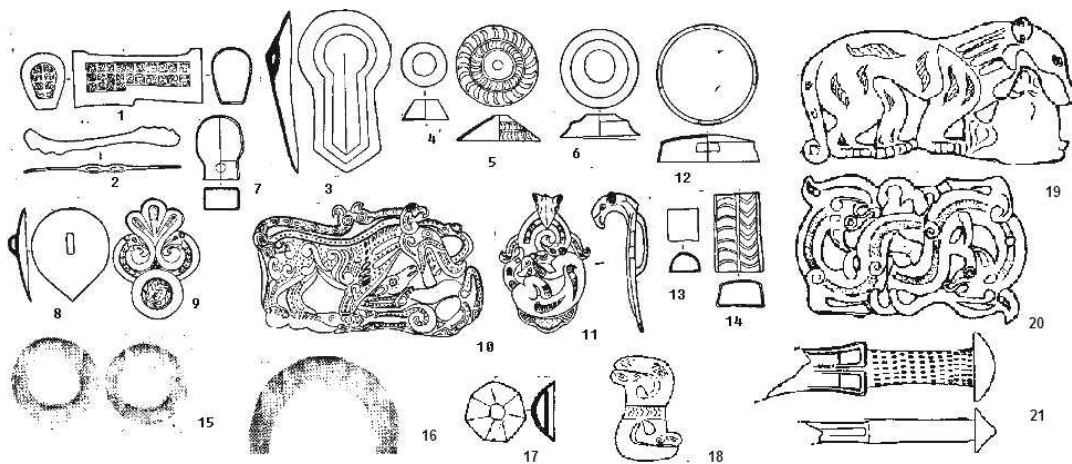


Fig. 030. Chenyangchuan, metal objects, 1-15 bronze; 16 silver, 1 Yuan-shaft of cart, L 13cm; 2 horse bit, L15.6cm; 3 Danglu, H 8.2cm; 4-6 bulb, dm 2.2cm.4.2cm.5cm; 7 pole top, H 3.2cm; 8-11 plaques, L 9.2cm.6.1cm.12.2cm.7.1cm; 12 Jieyue, dm 5.1cm; 13-14 tube, L 1.4-1.9cm; 15 loop, dm 6.8cm; 16 plaque, dm 9cm; 18 bird, L 5cm; 19.20 plaque, L 9.6cm.7.8cm; 21 iron sword, L 19cm (after Yan/Li 1992, 574 Fig. 1, 1.2.3.4.12.14.9.8.7.10.11.13; 574 Fig. 2, 3.2; Luo/Han 1990, 415 Fig. 14, 9; 414 Fig. 13, 9.413 Fig. 12, 2.3; 404 Fig. 1, 4).

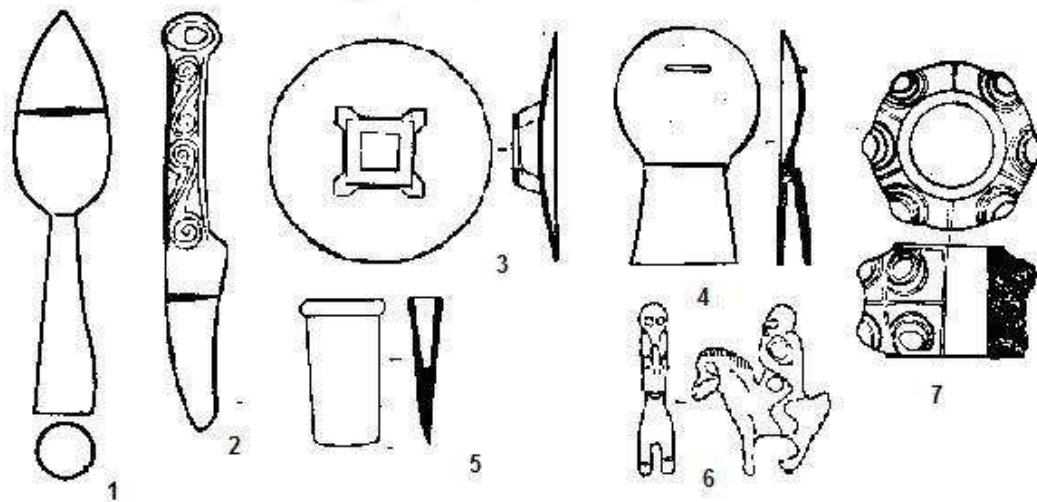


Fig. 031. Bronze objects, 1-2 from Danbei, L 14.8cm.15.6-17.4cm; 3-5 from Baizigou, L 9.3cm.7cm.9.6cm; 6 from Yuqiao, L 4cm; 7 from Maogou, dm 5cm (after Luo/Han 1990, 405 Fig. 2, 4; 407 Fig. 6, 12; 411 Fig. 10, 4,15; 408 Fig. 7, 3; 414 Fig. 13, 5; 406 Fig. 3, 5).

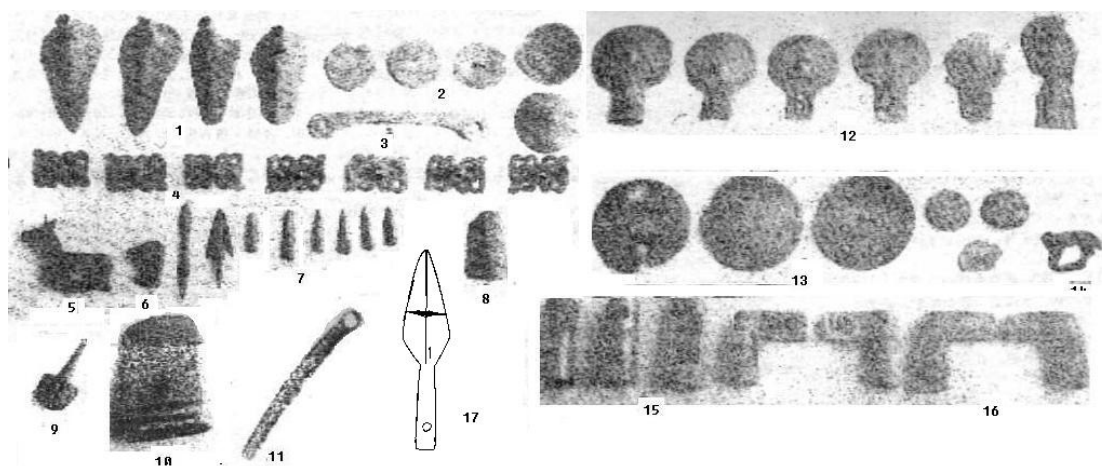


Fig. 032. Bronze objects, 1-8 from Wugou; 9-11 from Heshenlin; 12-17 from Shatang (after Wang J. Q. 1990, 5 Fig.1; 7 Fig. 3; 6 Fig. 2; Luo/Han 1990, 405, Fig. 2, 3)

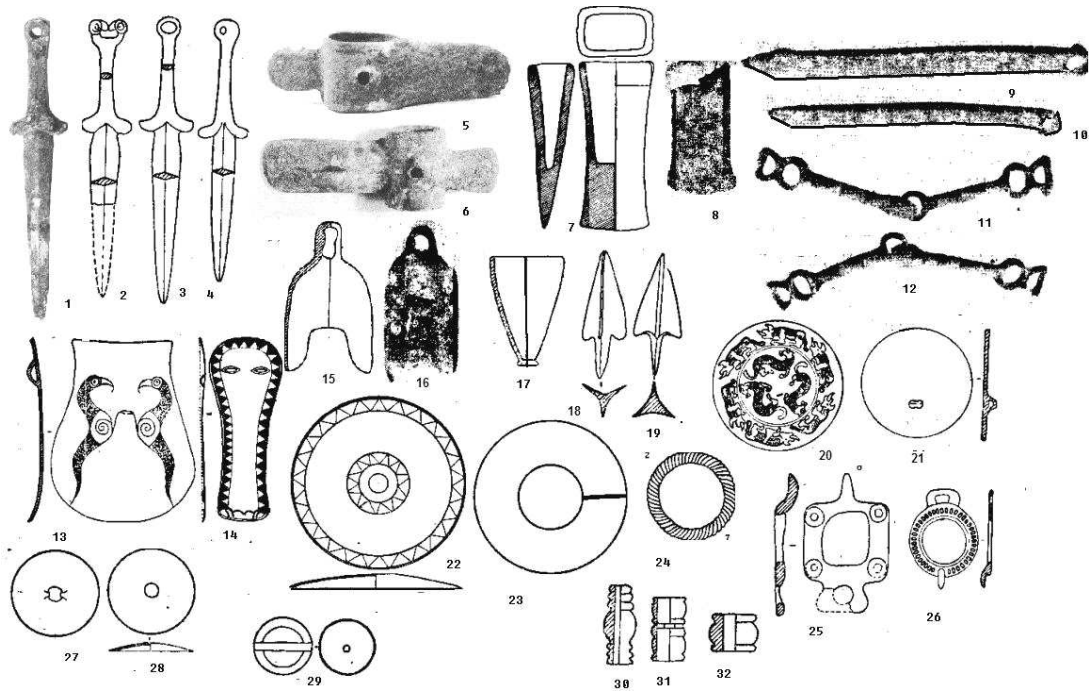


Fig. 033. Niding, bronze funeral objects, 1-4 short sword, L 30.03cm.18.3cm.28.4cm.27.4cm; 5-8 axe, L 12cm.11.3cm.9.5cm.7.8cm; 9-10 knife, L 17.cm.20.04cm; 11-12 gag bit, L 20.4cm.21.4cm; 13-14, Danglu, L 10.4cm.21cm; 15-16 bell, H 6.1cm.6.5cm; 17 Dun, H 3.7cm; 18-19 arrowhead, L 3cm.4cm; 20-21 mirror, dm 7.4cm.3.5cm; 22-24 loop, dm 9.8cm.8.5cm.4.9cm; 25-26, buckle, L 2.8cm.5.6cm; 27-29 bulb, dm 2.9-1.2cm; 30-32 tube, L 2.3-1cm (after Zhong K. 1987a, Plate 1, 2; 774 Fig. 3, 1-3; Plate 1, 7; 775 Fig. 4, 6; Plate 1, 6; 776, Fig 7; 775 Fig. 5; Fig. 4, 3.4; 774 Fig. 3, 11; 776 Fig. 6, 2; 774 Fig. 3, 15.4.5; 775 Fig. 4, 9; 774 Fig. 3, 13.16.17.10.7.8.9).

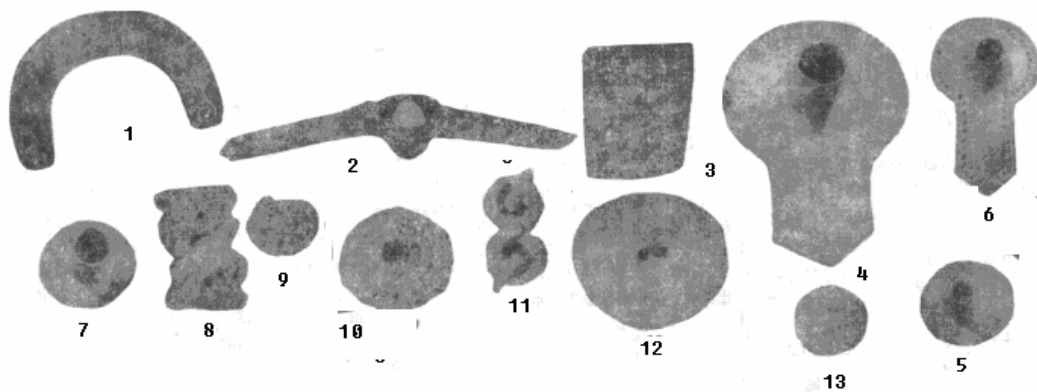


Fig. 034. Xijiao, collected metal objects, 1 made of silver, width 3.8-4.9cm; 2-13 made of bronze, 2 pickaxe, L 14cm; 3 adze, L 4.8cm; 4-7 tubular ornament, L 3.4-8.94cm; 9.13 bulb, dm 2.4-2.6cm; 10.12 horse mask, dm 3.9cm.5.2-6.7cm; 14 plaque, L 13.7cm (after Zhong K. 1978, 89 Fig. 9, 1-13).

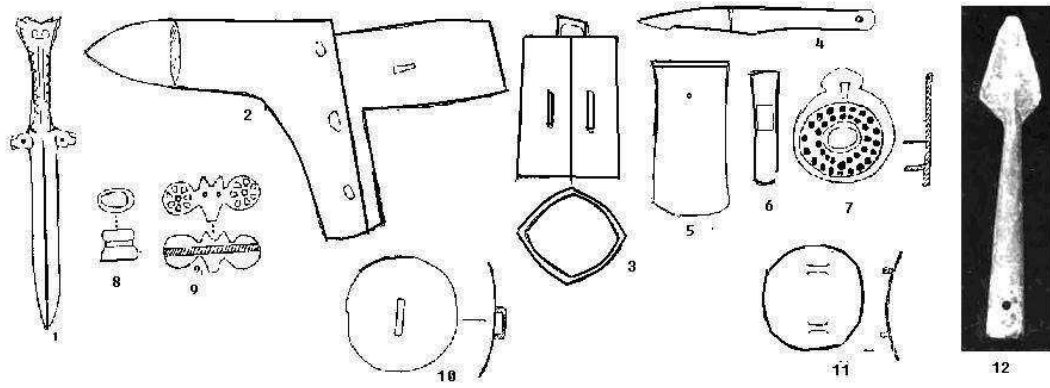


Fig. 035. Yangwa, bronze objects, 1 sword, L 26cm; 2 dagger, L 17cm; 3 bell, L 7cm; 4 knife, L 20cm; 5 adze, L 6.5cm; 6 chisel, L 4.6cm; 7 buckle, dm 3.7cm; 8 loop; 10-11 plaque, dm 4.2-11.1cm; 12 spear, L 16cm (after Zhong/Han, 1985, 204 Fig. 1, 1-8.10-12; Luo F. 1983, Plate 25, 4).

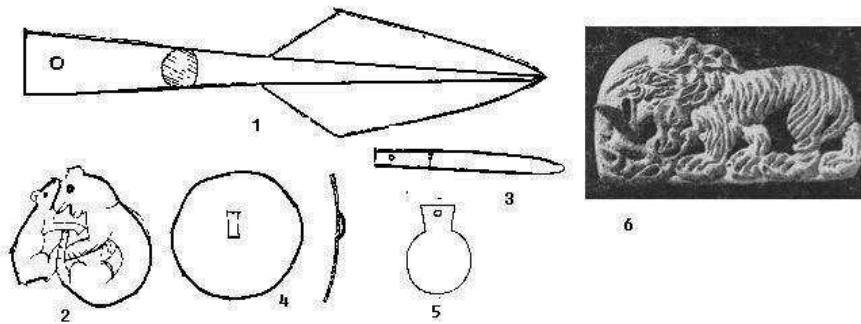


Fig. 036. Dabeishan, bronze objects (after Zhong/Han 1985, 205 Fig. 2, 12.5.1.2.3; cover).

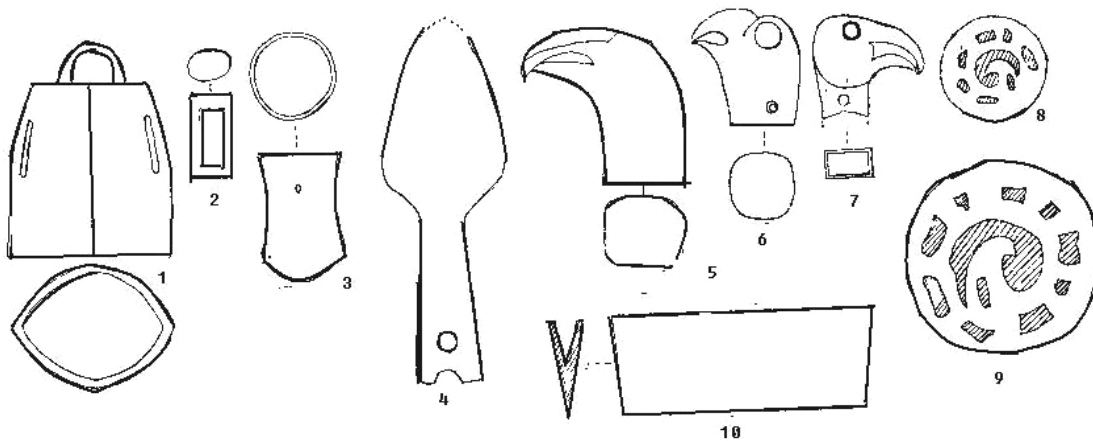


Fig. 037. Wangjiaping, bronze objects (after Zhong/Han 1985, 205 Fig.3, 1-10).

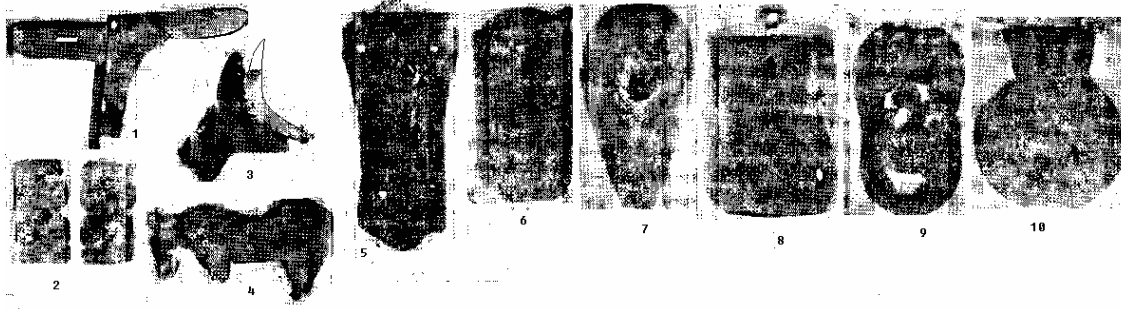


Fig. 038. Lüping, bronze objects, 1 dagger, L 22cm; 2 plaque, L 4.2cm; 4 animal, L 8.5cm; 8 bell, L 15cm; 9 buckle, L 7.2cm; 10 shovel shaped plaque, L 10.2-7.8cm (after GYB 1992, 469 Fig. 1, 1-4; 470 Fig. 2).

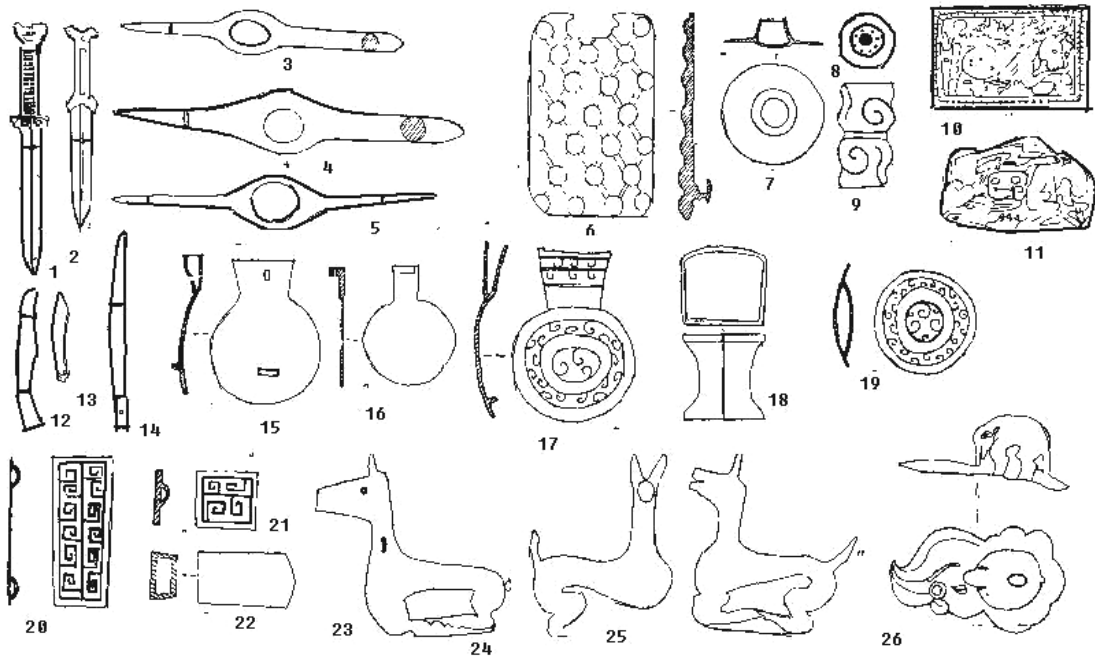


Fig. 039. Guyuan, collected bronze and gold objects (10.11 gold; others bronze), 1-2 sword, L 29.6cm.22.5 cm; 3-5 crane hawk, L 12.8cm.16cm.14.5cm; 19 plaque, dm 3.6-4.8cm; 18 L 3.3-4.5cm; 23-26 sheep, L 5.5-7.5cm; 26 H 3cm (after Zhong/Han 1985, 206 Fig. 4; 207 Fig. 5).

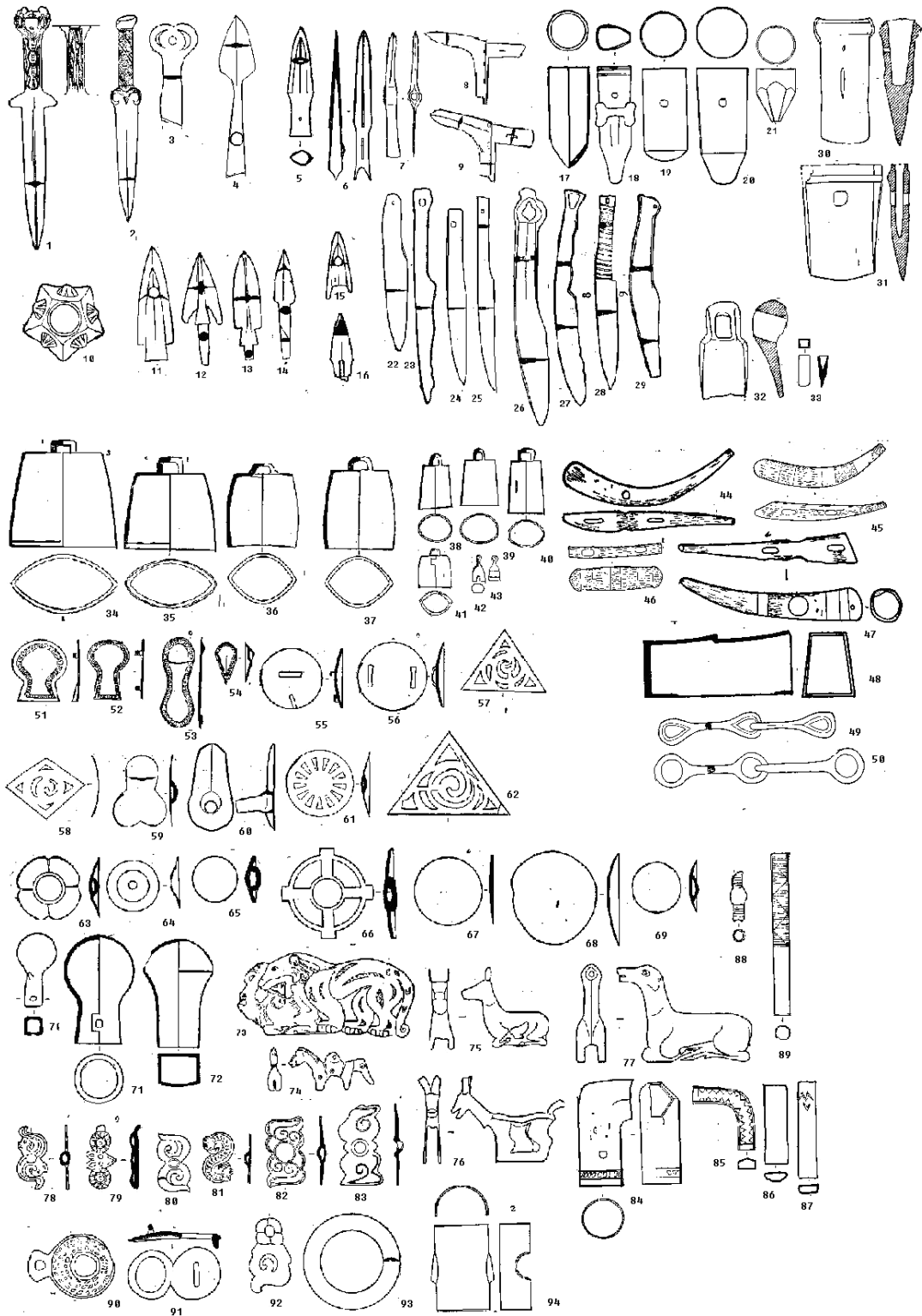


Fig. 040. Ningxia, metal objects, 1.4.9.17.19.20.21.22.29.33.34.35.36.37.38.39.40.43-48.51-59.61.62.64-72.76-79.81.83-88.90.91.94 from Samen; 2 from Lüyuan; 3 from Nanjiao; 7.42.60.63.80.82.89.92.93 from Luzigou; 8 from Siyingshuiku; 9.10.22.75 from Xijiao; 18 from Sanying; 24.31 from Tianwa; 73 from Shangtai, 5.6.11-16.25.26.27.28.32.49.50 collected from Guyuan county, 1-3 sword, L 28.6cm.14.2cm.7.4cm; 4-6 spear, L 16cm.15.2cm.22cm; 7 crane hack, L 9.3cm; 8-9 dagger, 25.3cm.19cm; 10 pole top, dm 4.4cm; 11-16 arrowhead, L 5.8cm.3.9-5.9cm; 17-21 Dun, L 10cm.11.6cm.9cm.11.2cm.5.3cm; 22-29

knife, L 11-22.4cm; 30-31 adze, L 10.2cm.9.3cm; 32 shovel, L7.6cm; 33 chisel, L 2.5cm; 34-43 bell, L 35-18cm; 44-47 horse bit, L 14.6cm.11cm.8cm.15.6cm; 48 axle, L 12cm; 49-50 gag bit, L15cm.18cm; 63-69 bulb, dm2.3-5.4cm; 70-72 pole top, dm 4-6 cm; 73 plaque, L 10.6cm; 74-77 figure, L 4.9-8.5cm; 78-83 buckle, L 3-4.8cm; 84-89 tube, L 5.2-6.8cm; 94 hoop, L 5.5cm (after Luo/Han 1990, 404 Fig. 1, 1.3.6; 405 Fig. 2, 1.7.8; 406 Fig. 3, 1.6.7.4; 406 Fig.4, 1-6; 406 Fig. 5, 1-5; 407 Fig. 6, 1.2.4.6.8-10; 408 Fig. 7, 4.10.7; 409 Fig. 8, 8.9.6.7.3.4.5.11.1.2; 410 Fig. 9, 4.1.2.3.5.6.7; 411 Fig. 10, 1.6.7.8.2.3.4.10.12.13.14.5.11; 412 Fig.11, 1.8.7.9.3.4.7.11.12.13; 413 Fig. 12, 5; 414 Fig. 13, 1.2.3.4.6.10.7.8.11.12; 415 Fig. 14, 1.8.12.14.2.15.5.6.10.11.3).

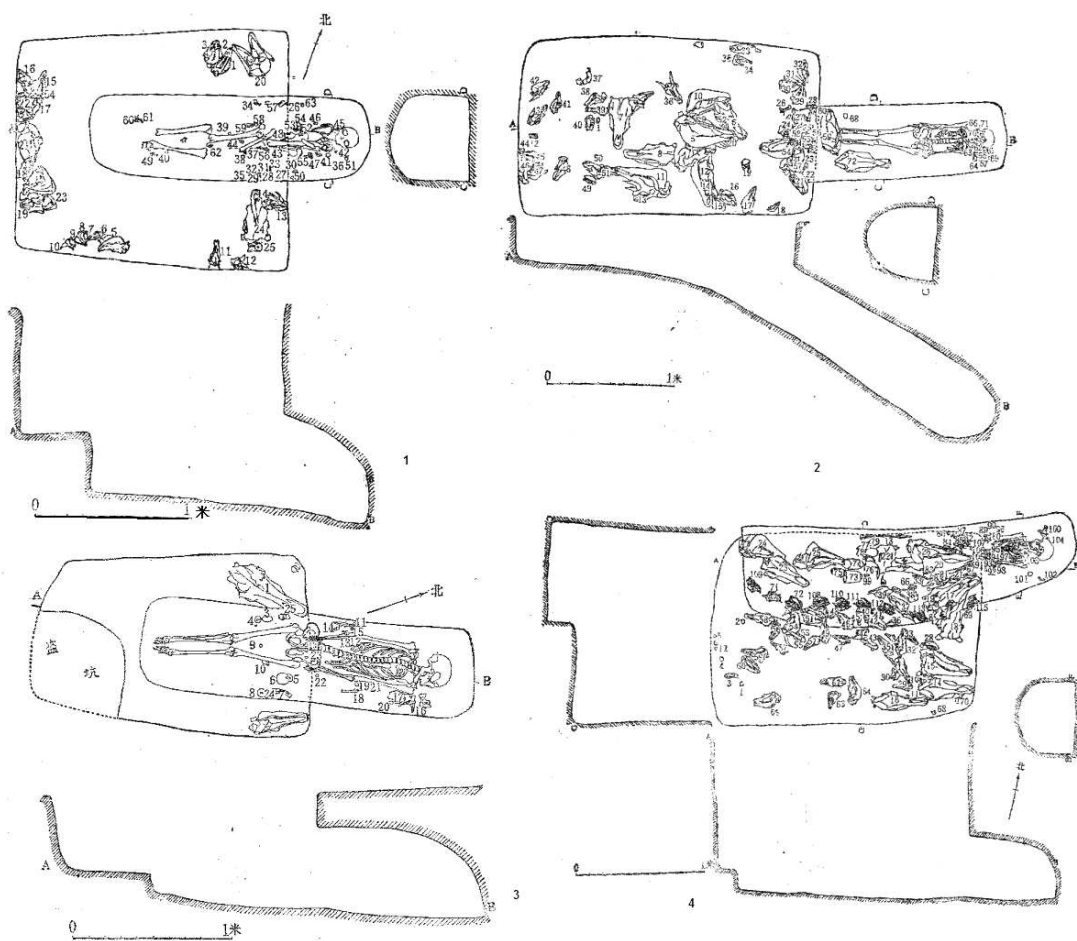


Fig. 041a. Guzhuang, 1 Tomb IIM1; 2 Tomb IIM3; Tomb IM4; Tomb IIM4 (after NXY et al. 1993, 24 Fig. 12; 25 Fig. 13, 26; 23 Fig. 11; Fig. 14).

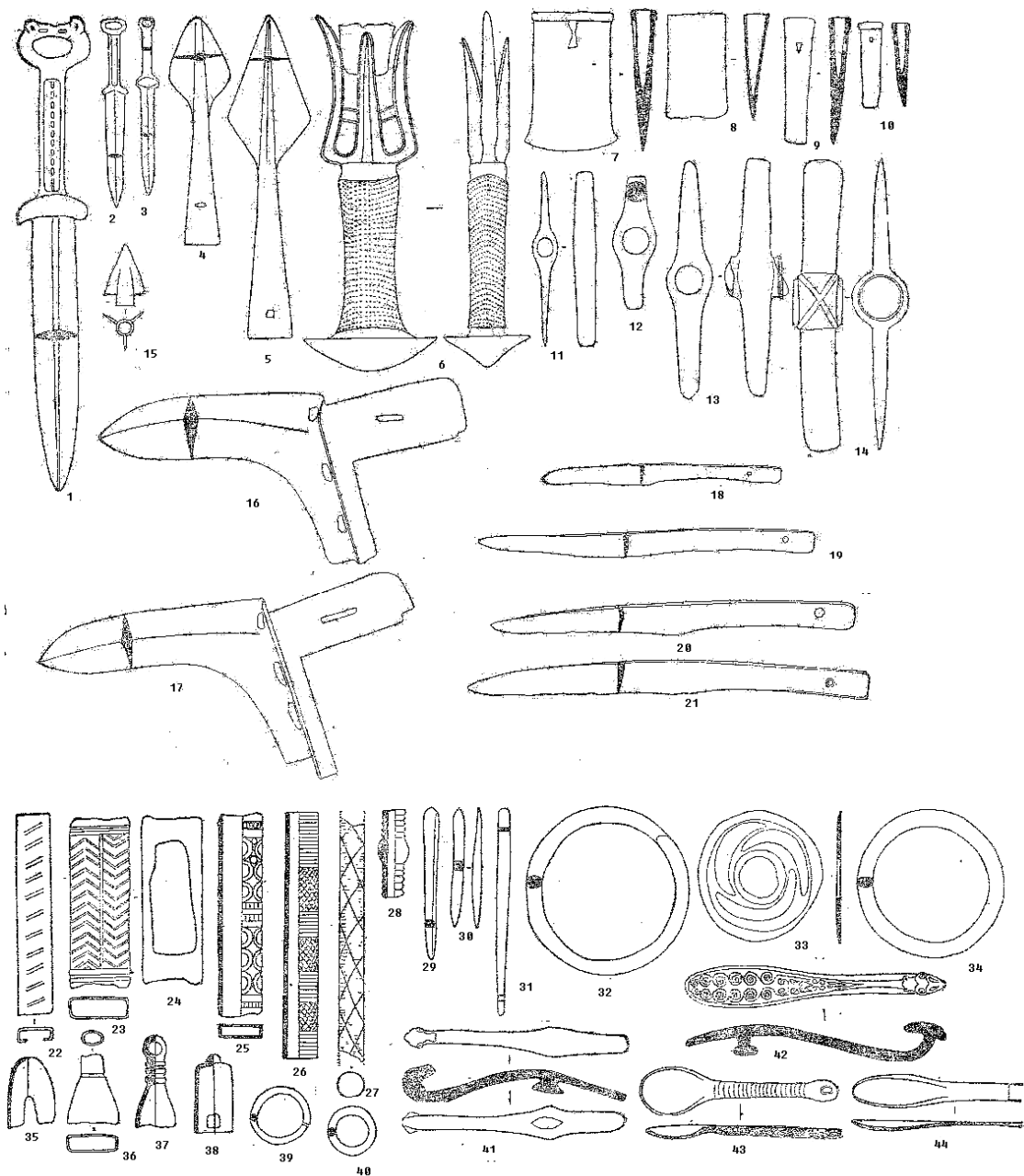


Fig. 041b. Mazhuang, bronze funeral objects, 1-3 sword, L 20.2cm.20.2cm.18.8cm; 4-5 spear, L 18.9cm.17.2cm; 6 iron sword with bronze handle, L 18.9cm; 7-8 axe, L 7.4cm.5.5cm; 9-10 chisel, L 6.7cm.4.6cm; 11-14 crane hack, L 9.3cm.7cm.12.6cm.15.6cm; 15 arrowhead, 16-17 dagger, L 19.3cm.19.9 cm; 18-21 knife, L 12.6cm.18.1cm.19.5cm.21.6 cm; 22-28 tube, L 3.2-8.7cm; 29-31 awl, L 5.5cm.4.4cm.7.9cm; 32-34 loop, dm 5.7cm.4.7cm.5.5cm; 35-38 bell, H 2.6-3.5cm; 39-40 earrings, dm 2.2, 1.7cm; 41-42 hook, L 8.4cm.9.7cm; 43-44 spoon, L 7.5, 5.9cm (after NXY et al. 1993, 29 Fig. 16, 1-21; 31 Fig. 17, 1-22).

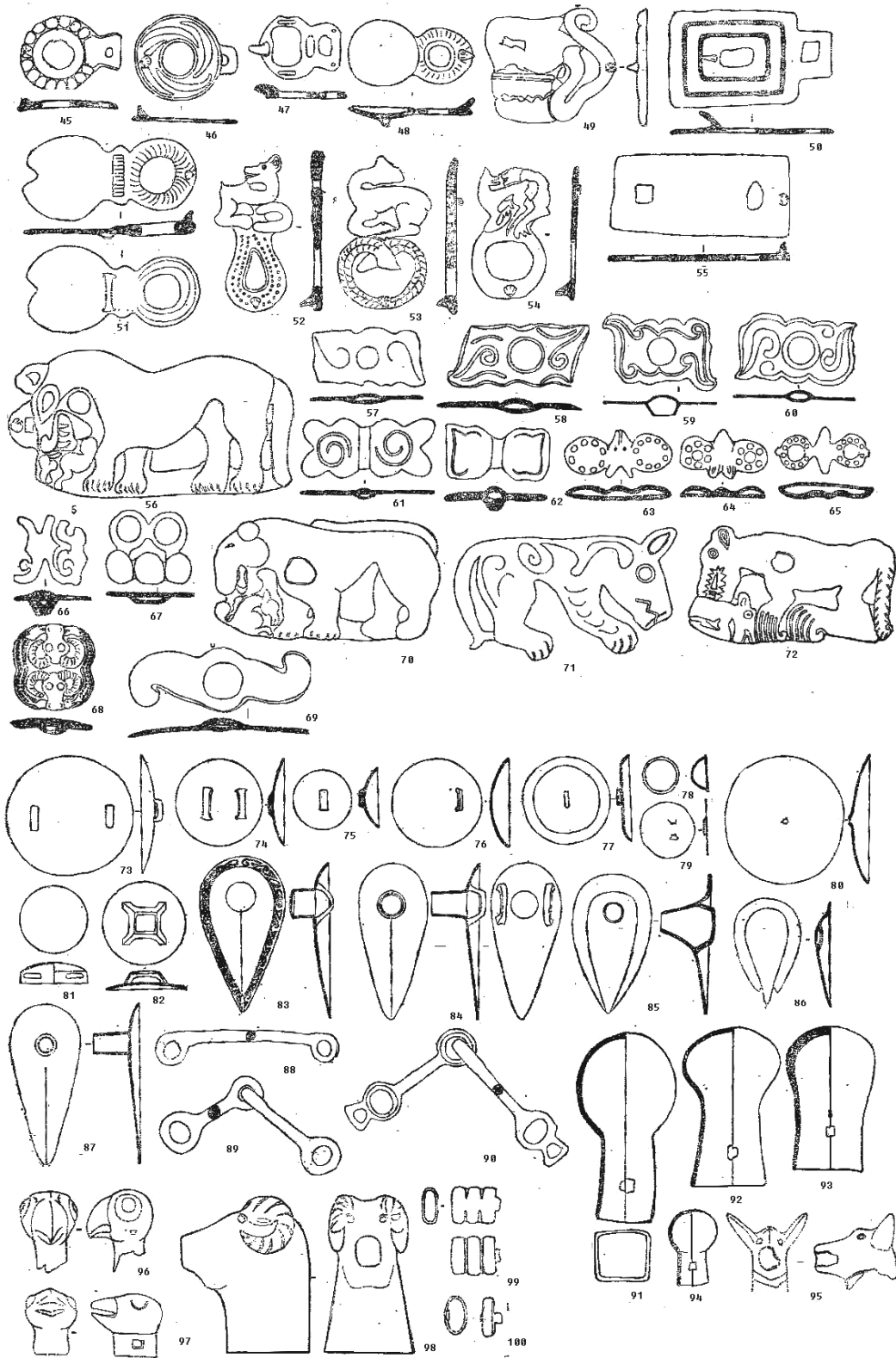


Fig. 041c. Mazhuang, bronze funeral objects, 45-56 buckle, L 4.2-12cm; 57-72 belt ornament, L 4.6cm.5cm.4.4cm.5cm.5.8cm.4.4cm.4.7cm.3.7cm.4cm.2.9cm.3.8cm.3.6cm.7.7cm.9.5cm. 9.3cm.8.1cm; 73-80 bulb, dm 2.5-8.8cm; 81-82 Jieyue, dm 4.8cm.5.8cm; 83-87 Danglu H 10.8cm.11cm.9.8cm.7.3cm.11cm; 88-90 horse bit, L 13cm.14.8cm.20.1cm; 90-98 pole top, L 8cm.6.2cm.6cm.3cm.3.4cm.3.4cm.3.4cm.6.7cm; 99-100 hoop, dm 1.5cm.1.5cm (after NXY

et al. 1993, 32 Fig. 18; 33 Fig. 19; 36 Fig. 20).

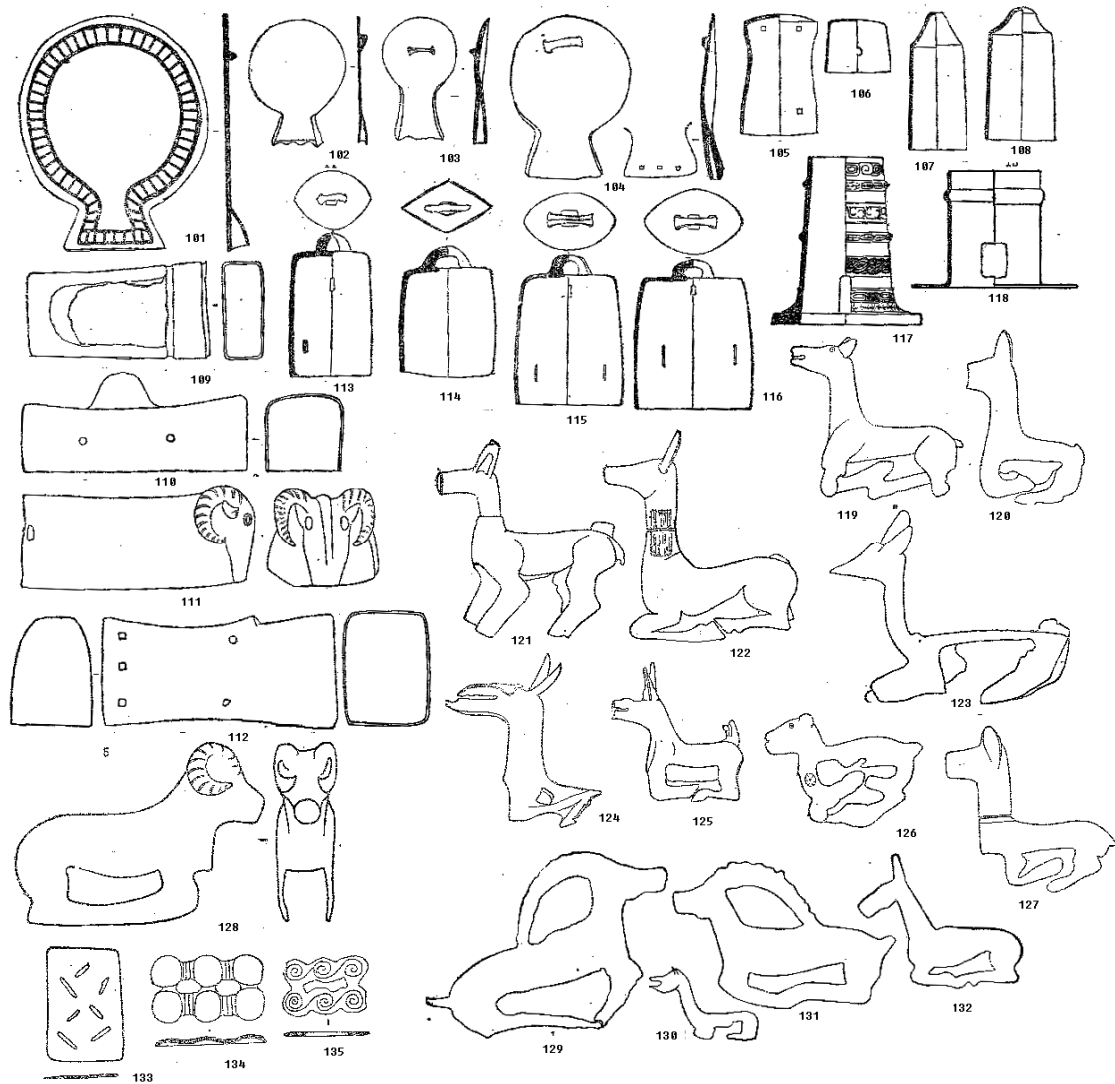


Fig. 041d. Mazhuang, bronze funeral objects, 101-104 plaque, H 12.6cm.6.7cm.6.5cm.8.7cm; 105-108 Wei (韋), H 6.5cm.2.9cm.7.2cm.7.5cm; 109-112 shaft of cart, L 9.8-12.5cm; 113-116 bell, H 7.7-16cm; 117-118 Gu(轂), H 9cm.6.3cm; 119-128 animal figure, H 4.3-7.9cm; 129-132 animal plaque, H 6.6-13.8cm (after NXY et al. 1993, 38 Fig. 22; 41 Fig. 23; 42 Fig. 24).

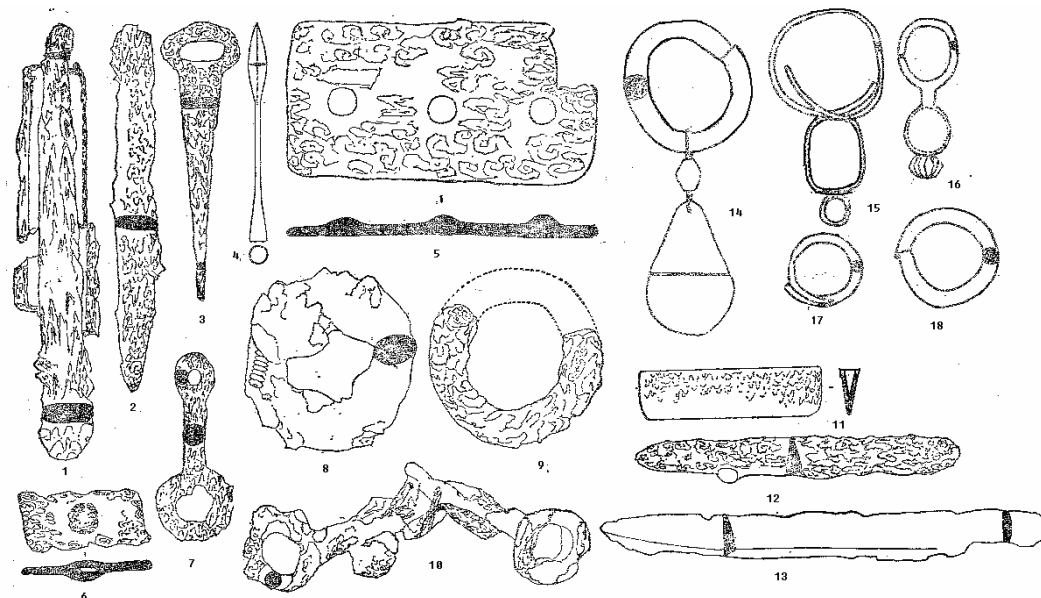


Fig. 041e. Mazhuang, metal objects, 1-12 iron objects; 13-17 gold and silver objects. 1-2 sword, L 21.5cm.18cm; 3 awl, L 13.7cm; 4 spear, L 43.2cm; 5-6 belt ornament , L 15.4cm.5.9cm; 7 horse bit, L 7.2cm; 8-9 loop, dm 8.9cm.8.5cm; 10 gag bit, L 17.6cm; 11 Cha (鍔), L 18cm; 12-13 knife, L 16.1cm.22cm; 14-16, L 7.5cm.5.2cm.3.9cm; 17-18 loop, dm 1.8cm.2.3 cm (after NXY et al. 1993, 25).

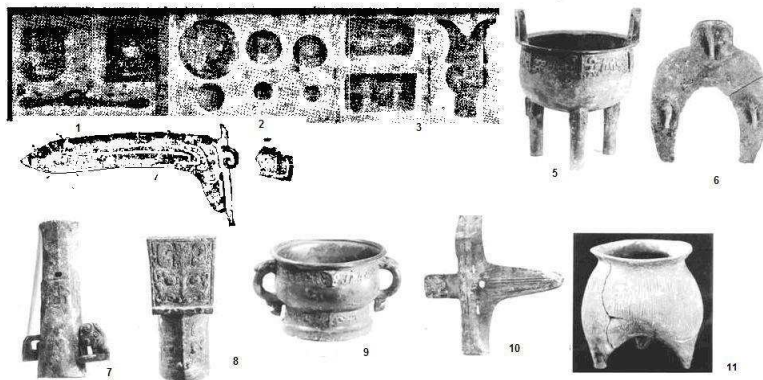


Fig. 042. Sunjiazhuang, funeral objects, 1-10 bronze; 11 pottery (after GYG 1983, 984 Fig. 4, 1-4; Plate 2, 1.2.4.3.5.6.7).

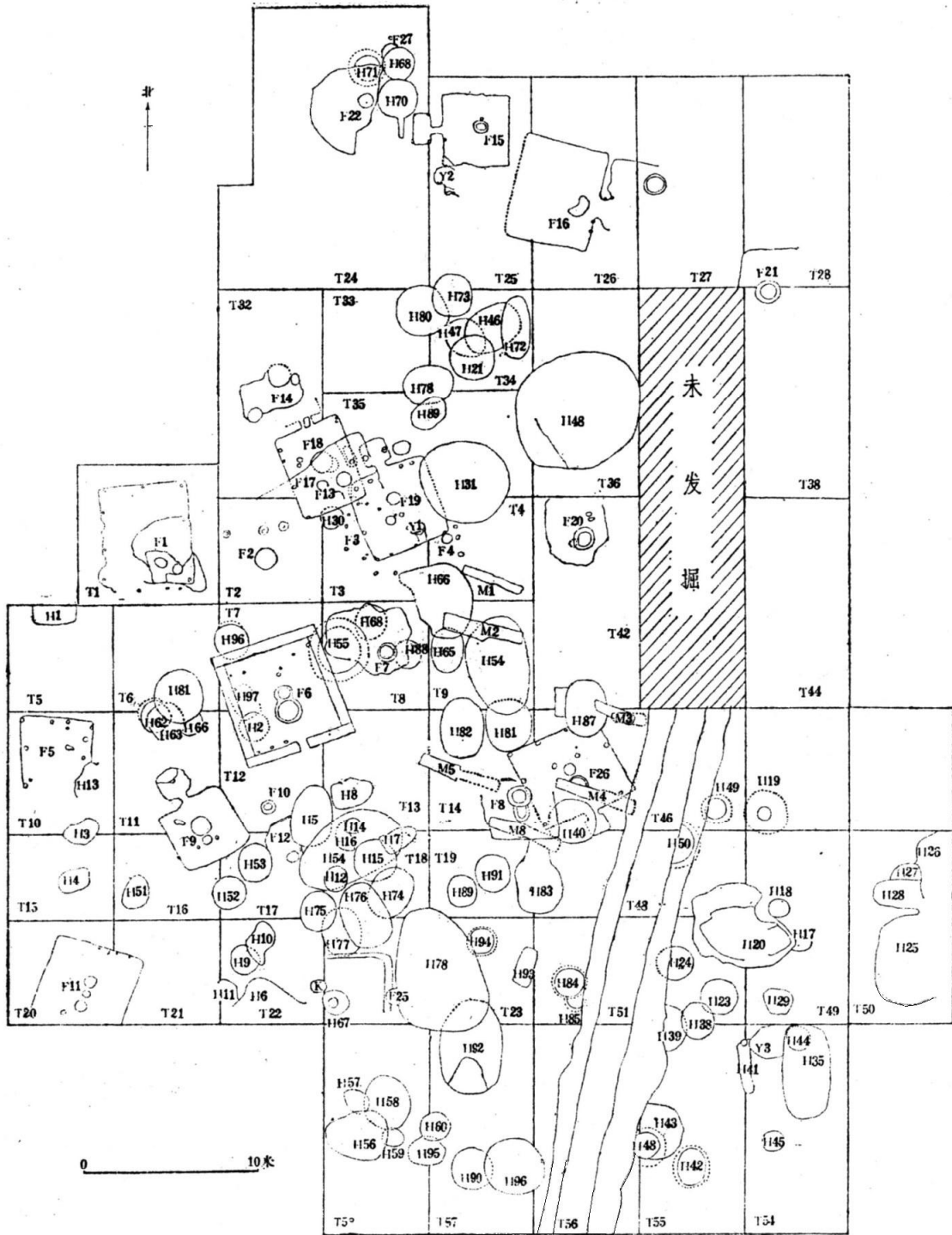
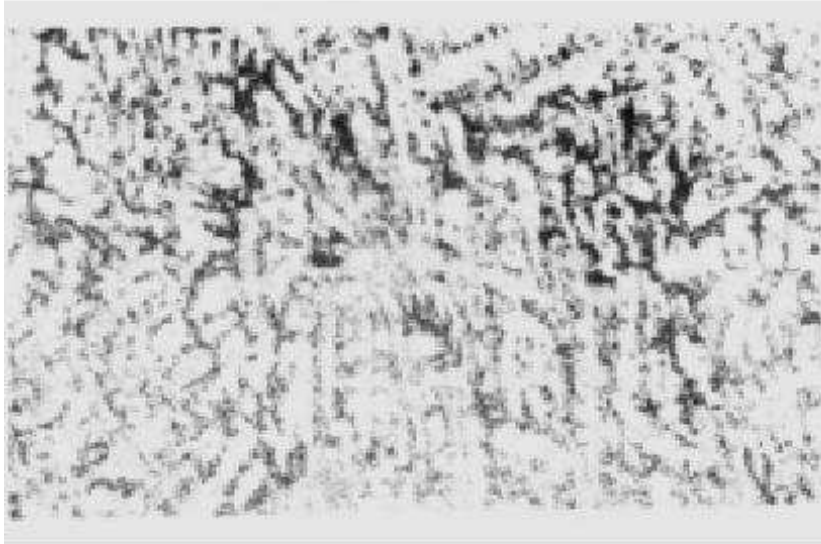


Fig. 043a. Linjia, plan of excavation district (after GSG et al. 1984, 114 Fig. 3).



1



2

Fig. 043b. Linjia. 1 bronze knife found from F20:18, L 12.5cm; 2 metallurgical structure of the bronze knife (after Sun/Han 1997, 76 Fig. 1; Fig. 2).

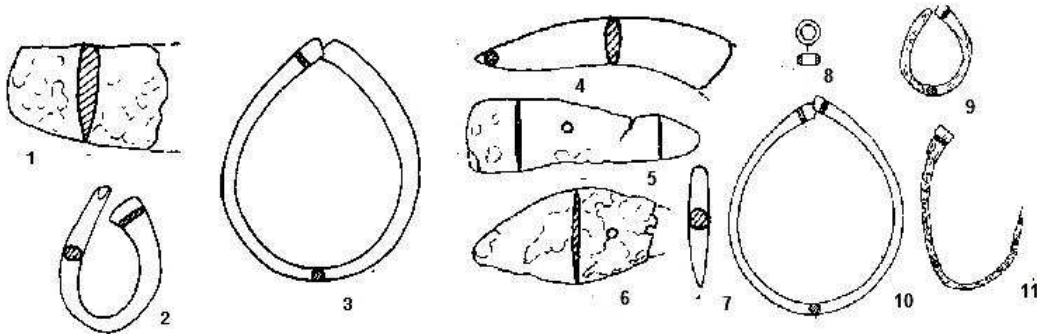
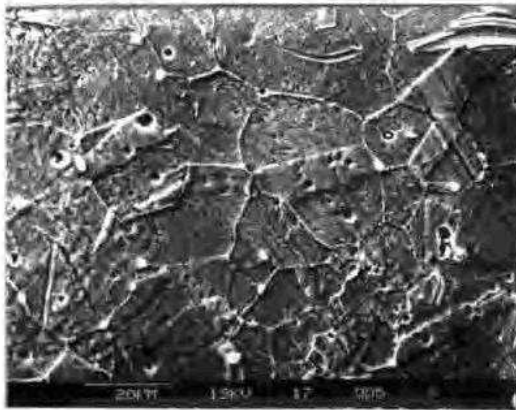
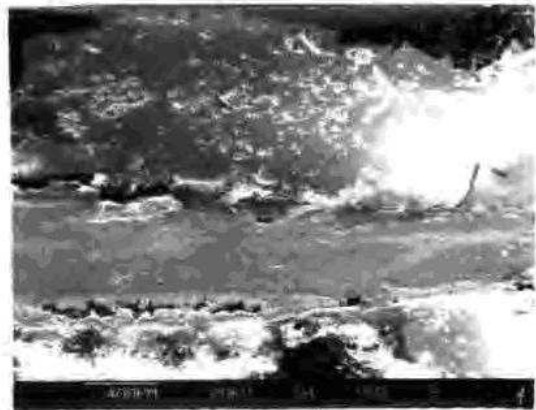


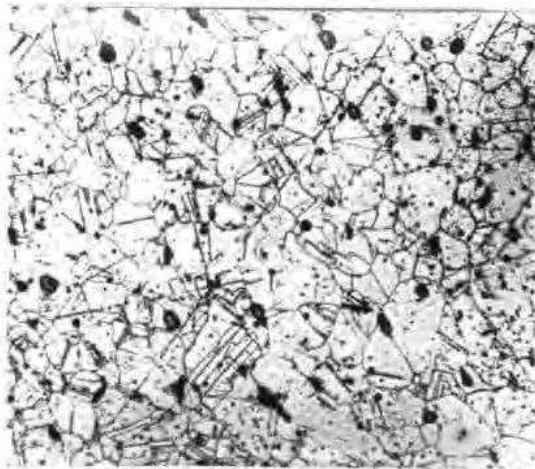
Fig. 044a. Donghuishan, bronze objects, 1-3 from dwelling remains; 4-11 from tombs, -1 knife (0155), L 3.15 cm; 2 earring, dm 2.4-3.6cm; 3 earring, dm 4.8-5.9cm; 4-6 knife, L 5.5cm.5cm.4cm; 7 awl, L 2.8cm; 8 ornament, dm 0.8cm; 9.10 earring, dm 7.4-5.8cm (after Donghuishan 98, 7 Fig. 7, 6; 24 Fig. 19, 3.5; 51 Fig. 44, 1-4; 93 Fig. 69, 2.5.4.8).



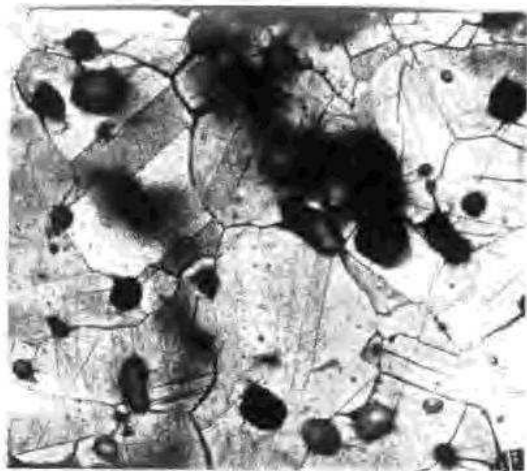
1 Tube (1672M23), Secondary electron image by scanning electron microscopy



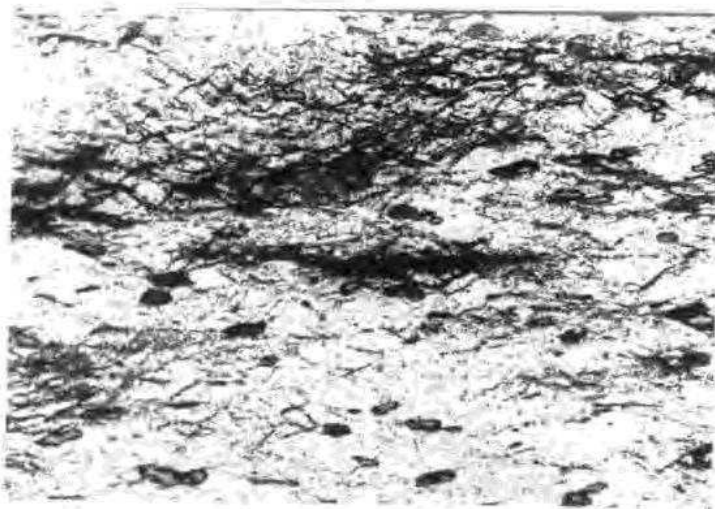
2 knife (1654M4:2), rust, Secondary electron image by scanning electron microscopy



3 Earring (1650T7), metallurgical structure X 250



4 Earring (1651 T17M21), metallurgical structure X200



5 Point of knife (1666M218:3), metallurgical structure X200

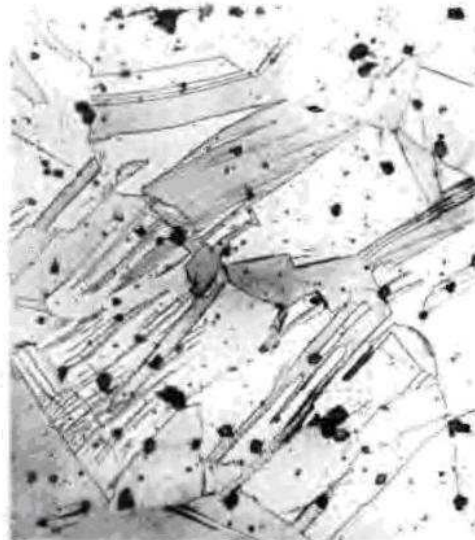
Fig. 044b. Donghuishan, secondary electron image by scanning electron microscope and metallurgical structure (adopted from Donghuishan 98, Plate 61).



1 Earring (1668M51)



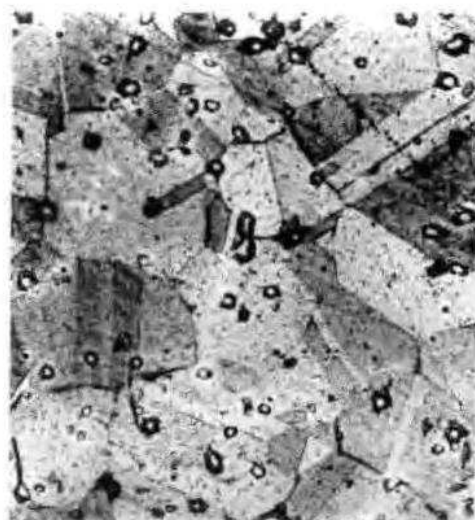
2 Earring (1669T12 @)



3 Earring (1670M79:1)



4 Awl (1671M157)



5 Earring (1674M34)

Fig. 044c. Donghuishan, metallographic structure of the bronzes (adopted from Donghuishan, Plate 62).

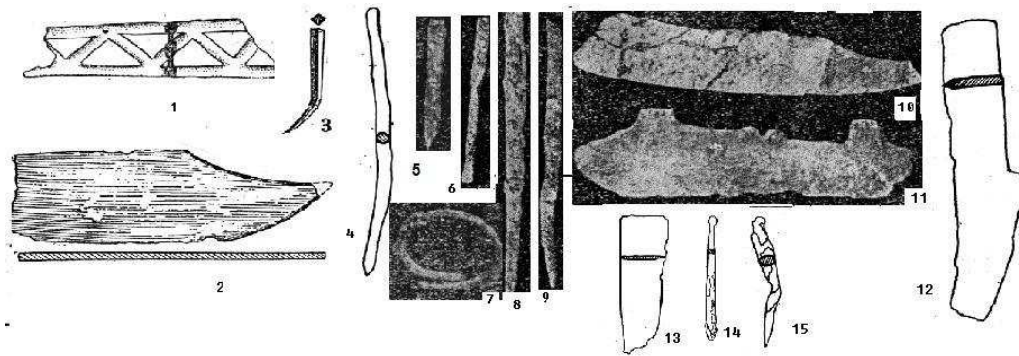


Fig. 045a. Huangniangniangtai, bronze objects, 1 fragment (H9③), L 6.7cm; 2 knife (T3②), L 6cm; 3 (T2②).4 (H6).5 (T6). 6 (T19②).8 (T10(3)).9 (T9(3)), L 3.8-12cm; 7 loop (T18(2)), dm 2cm; 10-13 knife, L 11.5cm.10.8cm.8cm.6.7cm; 14 drill (T3:7), L 5.2cm; 15 awl (T14:8) (after GSB 1960c: 60 Fig. 4, 1-4; Plate 4, 9.8.12.11.7.3.4; GSB 1978, 437 Fig. 21, 2-4.1).

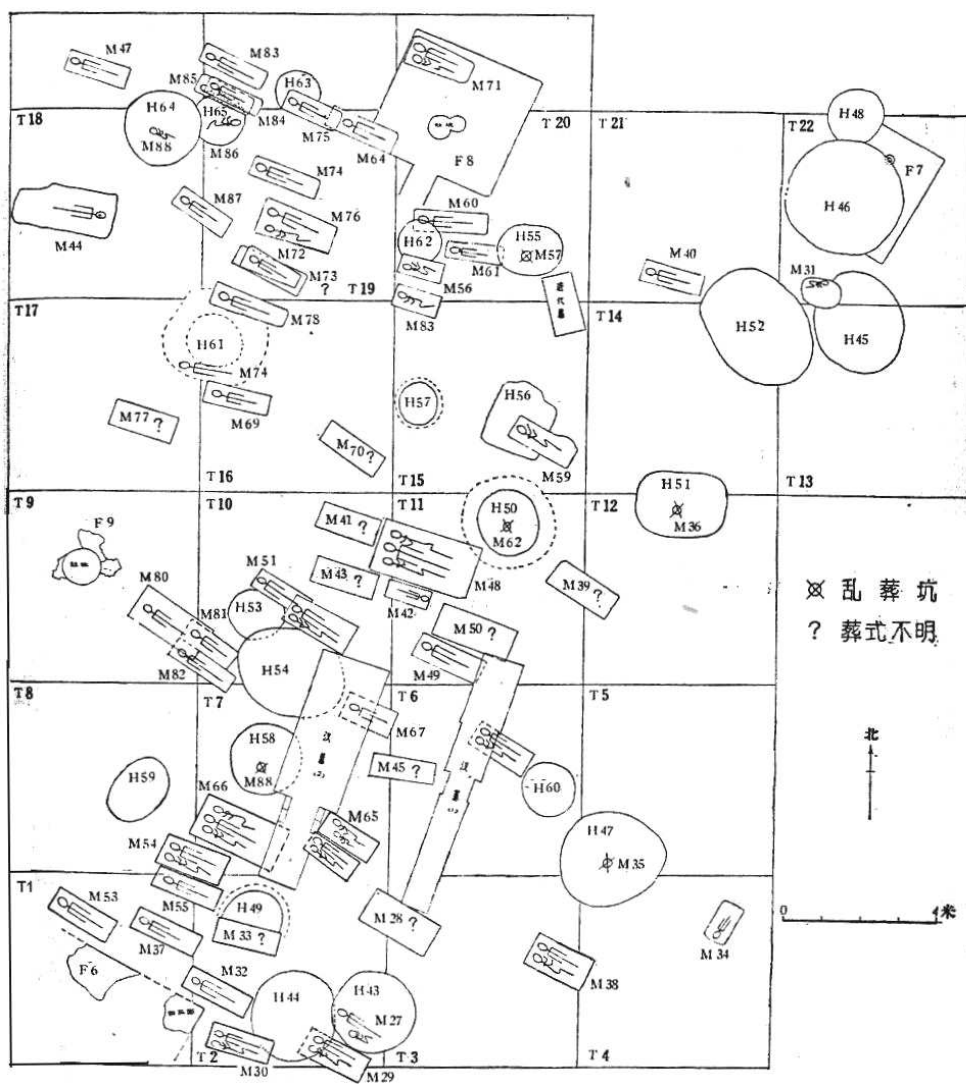


Fig. 045b. Huangniangniangtai, plan of the fourth excavation (after GSB 1978, 423 Fig. 3).

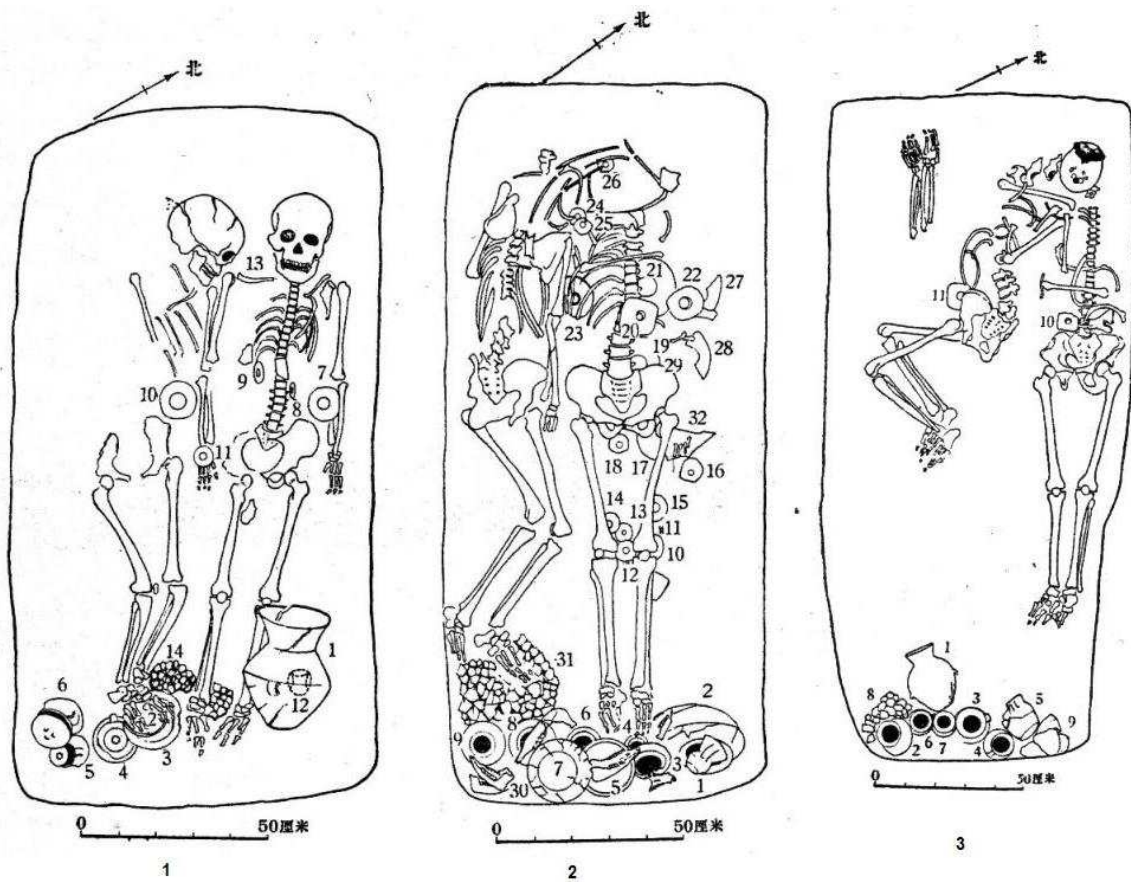


Fig. 045c. Huangniangniangtai, joint tombs, 1 Tomb M38; 2 Tomb M52; 3 Tomb M76 (after GSB 1978, 429 Fig.13; Fig. 14; 430 Fig. 15).

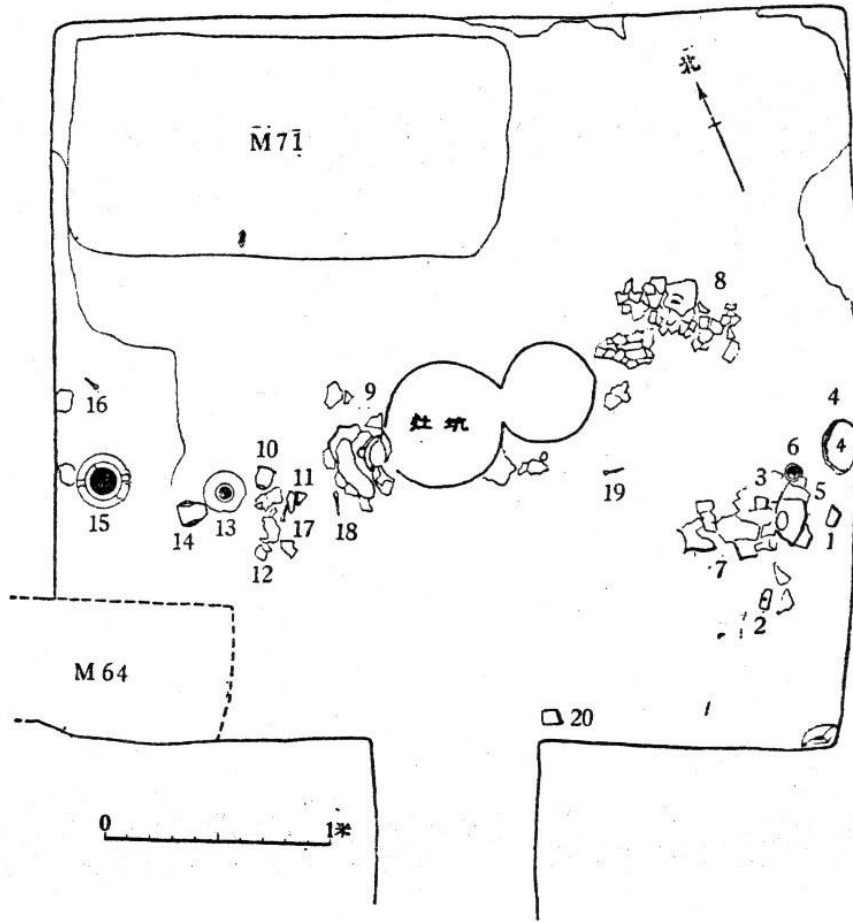


Fig. 045d. Huangniangniangtai, plan of House F8 (after GSB 1978, 424 Fig. 4).

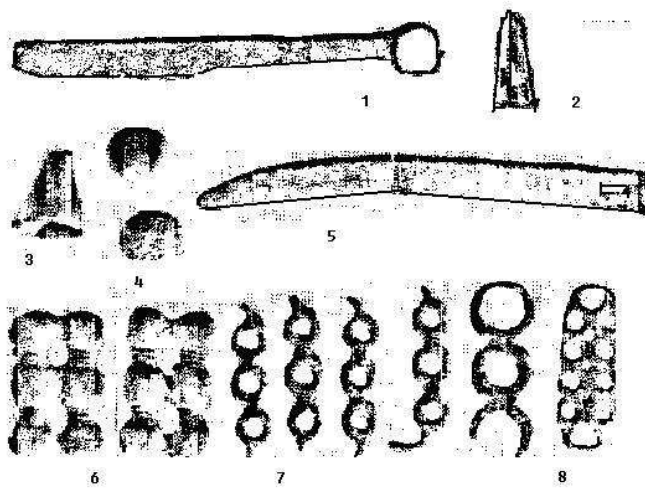


Fig. 046a. Bronze objects, 1.2 from Sanjiaocheng; 3-8 from Hamadun - 1 knife, L 15.8cm; 2 arrowhead, L 3.4 cm; 3 flaring shaped ornament, dm 2.1cm; 4 bulb, dm 1.8cm; 5 knife, L 12cm (after GSBG et al. 1984, 600 Fig. 3, 1.3; 601 Fig. 4, 1-6).

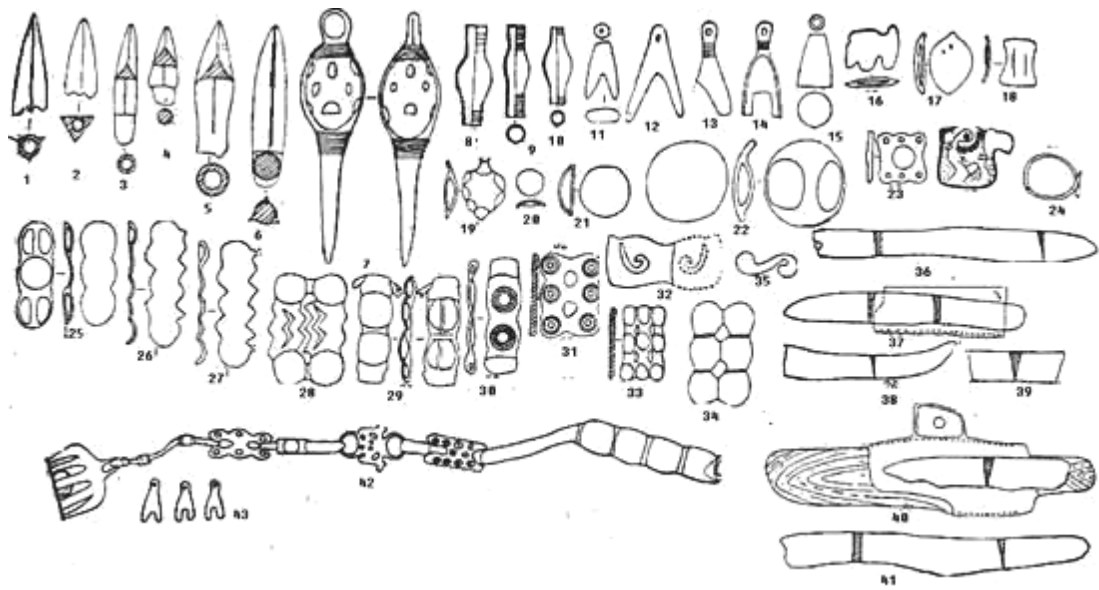


Fig. 046b. Bronze objects, 1-7 from Sanjiaocheng; 8-41 from Hamadun; 1-6 arrowhead, L 3cm.2.4cm.3.5cm.2.4cm. 4.1cm.4.8cm; 7 awl, L 7.7cm; 8-10 tube, L 2.9cm.3.4cm.3.1 cm; 11-15 bell, H 2.2-4.1cm; 16-18 ornament, H 1.9-2.4cm; 19-22 bulb dm 1.2-3.4cm; 23 plaque, L 2.1cm; 24 loop, dm 2.2cm; 25-31, 33-34 bead, H 3.3-5.4cm; 32 animal figure, L 3.3cm; 35 hook, L 2.5cm; 36-41 knife, L 11.5cm.9.7cm.7cm.4cm.7.5cm.12.2 cm; 42 whip, L 55cm; 43 (after GSY 1990, 215 Fig.10, 1-4.8.11.7.5; 226 Fig. 19, 1-12.13.11.14.15.22.16.17.29.18.19.20.36.21.35.33.34.23.24.25.26.27.38.39; 229 Fig. 20).

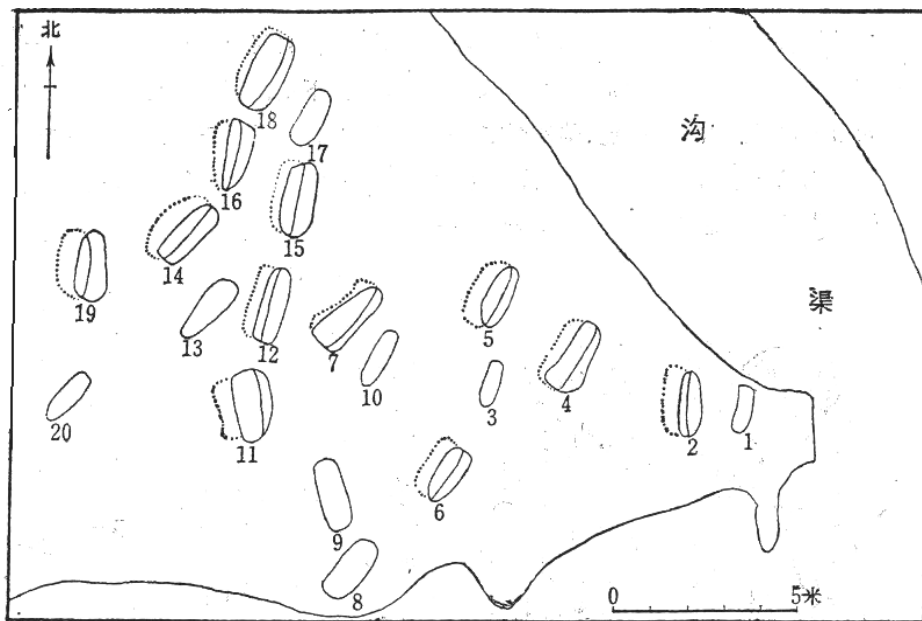


Fig. 046c. Hamadun, distribution of the tombs (after GSY 1990, 217 Fig. 11).

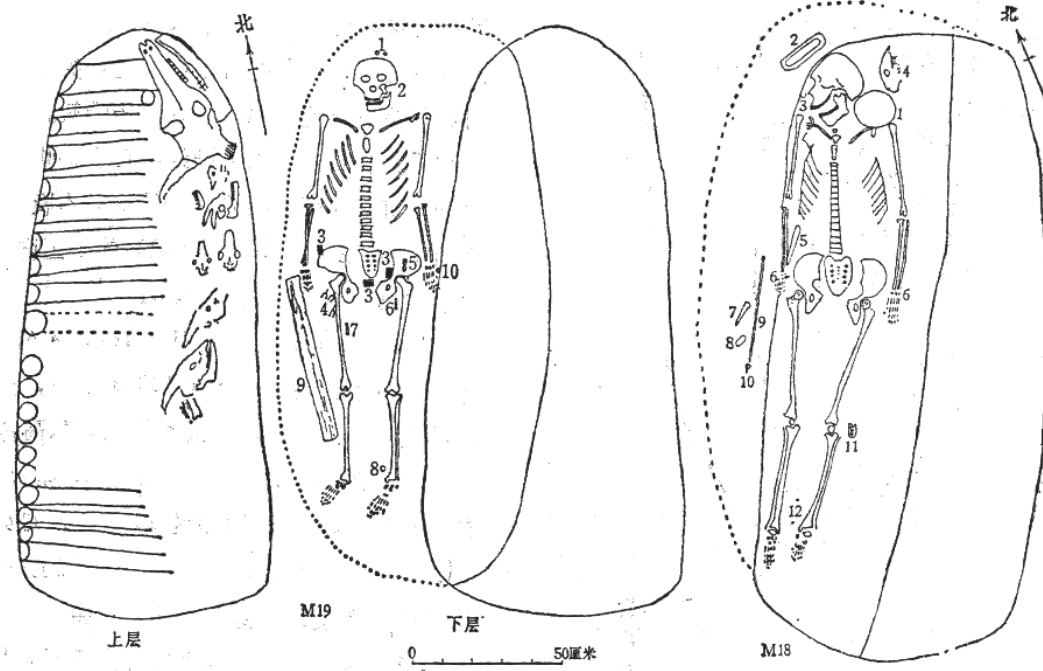


Fig. 046d. Hamadun, Tombs M19 and M18 (after GSY 1990, 219 Fig. 13).

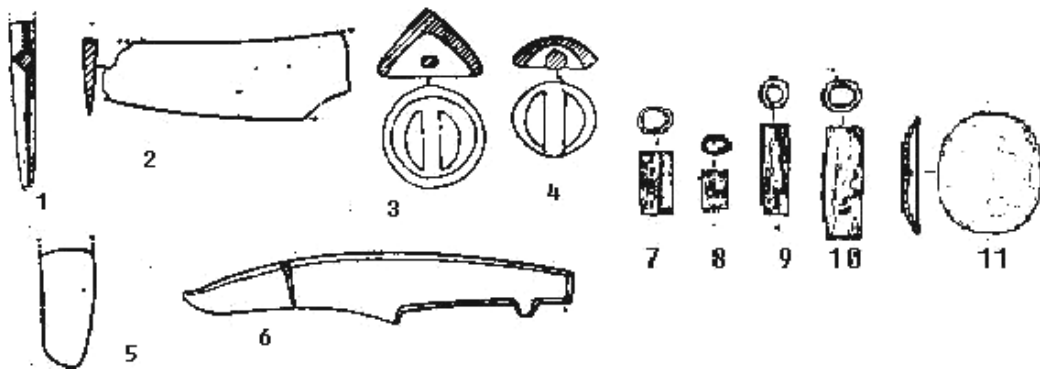


Fig. 047a. Lianhuatai, bronzes objects, 1 awl, L 5.2cm (appraised); 2 knife, L 4.5cm; 3-4 buckles, dm 1.6-1.4cm; 5 dagger, L 2.3cm; 6 knife, L 5cm; 7-10 bronze tubes, L 0.8-1.95cm; 11 buckle, dm 2cm (after Xie R. J. 1980a, 299 Fig. 7, 5.9; 300 Fig. 8, 8.10; 306 Fig. 13, 14.23; GSG et al, 1988, 15 Fig. 12, 1.2.3.8.7).

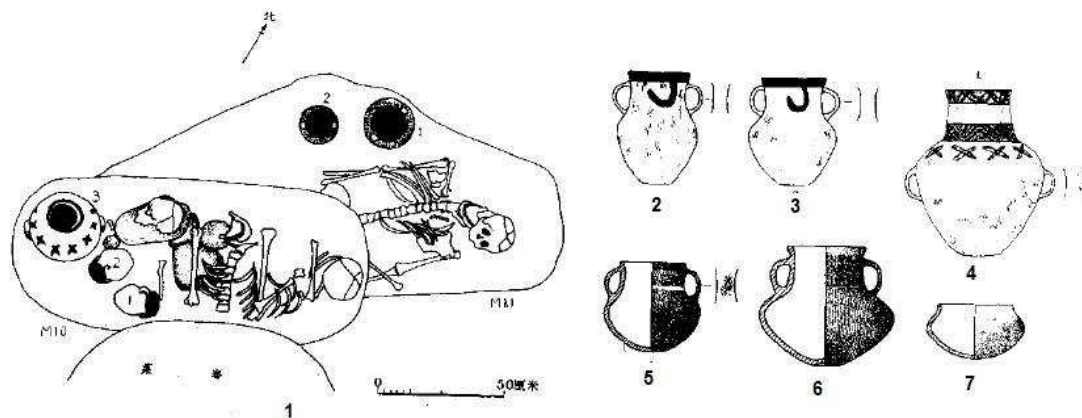


Fig. 047b. Lianhuatai, 1 plan of tomb M10 and M11; 2-4 potteries from Tomb M10; 5-6 potteries from Tomb M11 (after GSG et al. 1988, 9 Fig. 6; 13 Fig. 13, 5.6; 14, Fig. 11, 4; 11 Fig. 7, 4.6; 12 Fig. 8, 4).

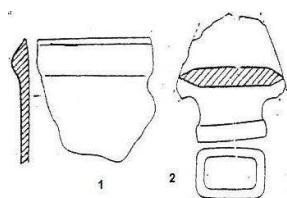


Fig. 048. Zhangjiazui, bronze objects, 1 fragment, 2 spear (after Xie R. J. 1980b, 194 Fig. 9, 4.6).

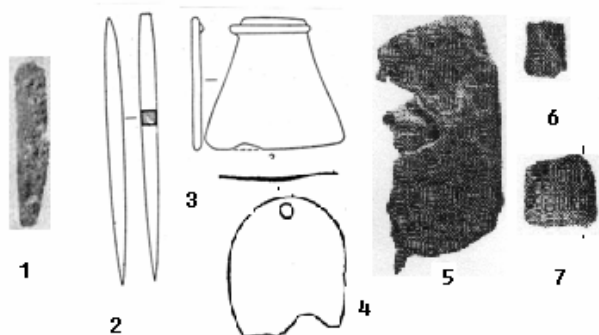


Fig. 049a. Copper and bronze objects, 1 from Dahezhuang; 2-7 from Qinweijia, 1 knife, L 12.5cm; 2 awl, L 8.2cm; 3 axe, L 4cm; 4 ornament, L 2.5cm; 5-7 fragments (after ZKKG 1974, plate 18, 10; Xie R. J. 1975, 73 Fig. 12, 1.2.3; Plate 12, 17.15.14).

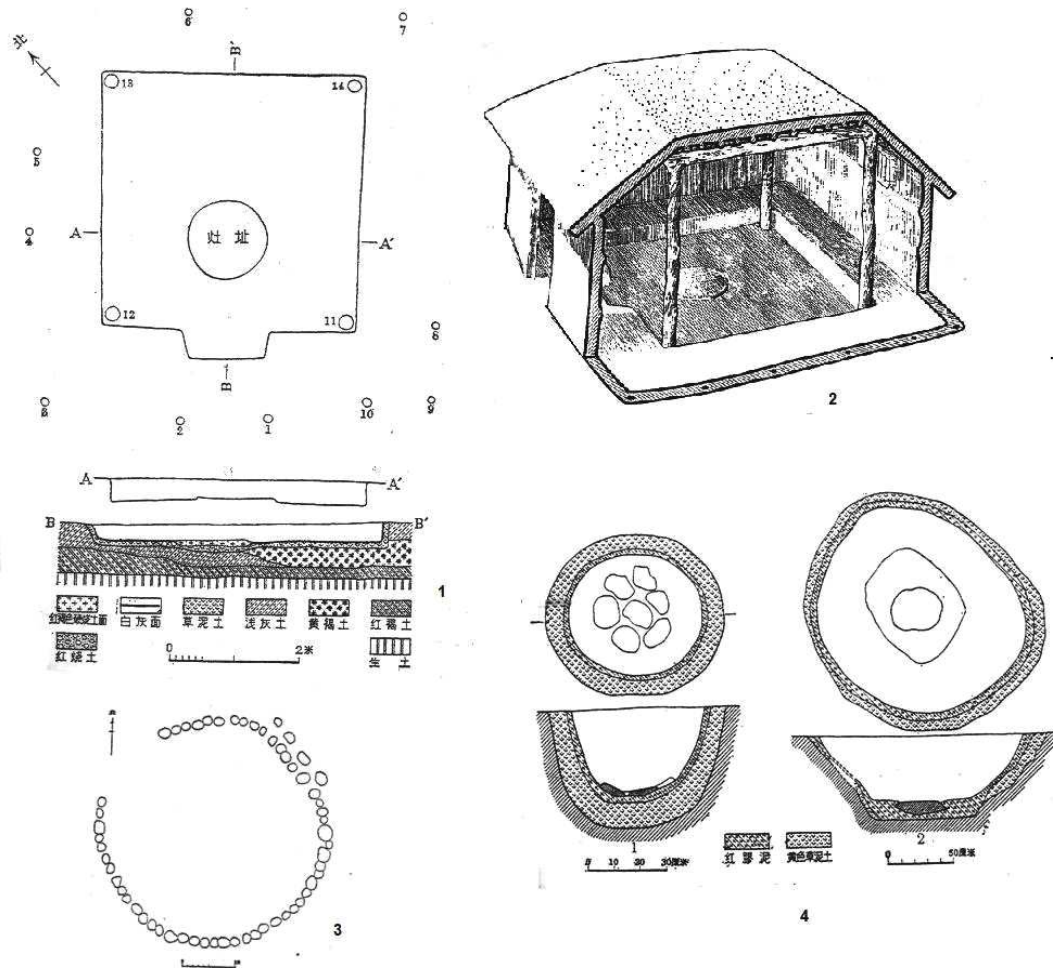


Fig. 049b. Dahezhuang, 1 plan of House F7; 2 recovery of House F7; 3 Plan of F1; 4 pit H10 and H7 (After ZSKKG 1974, 34 Fig. 6; 36 Fig. 7; 38 Fig. 12; 37 Fig. 10).

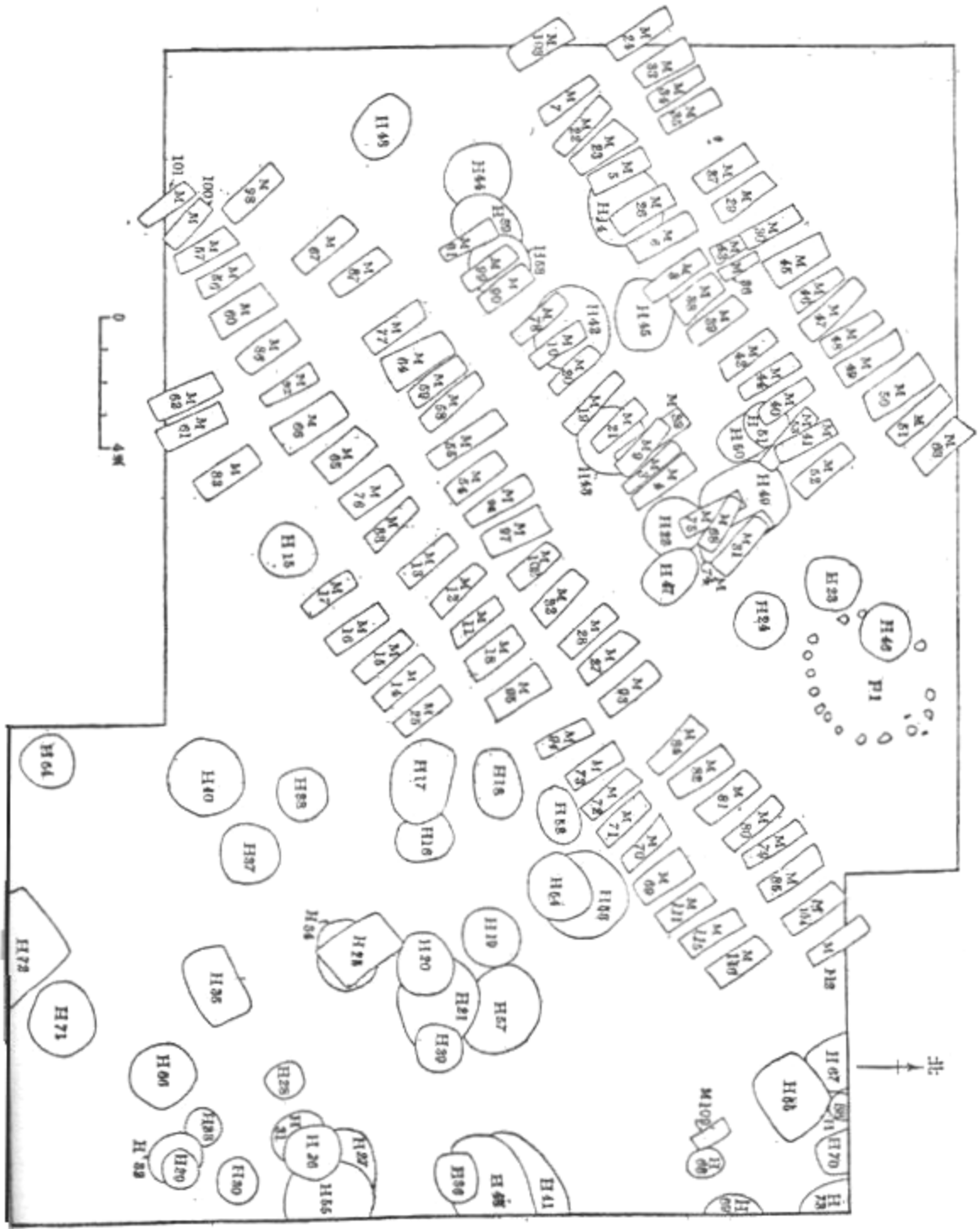


Fig. 050a. Dahezhuang, the southern part of the cemetery (after Xie R. J. 1975, 60 Fig. 3).

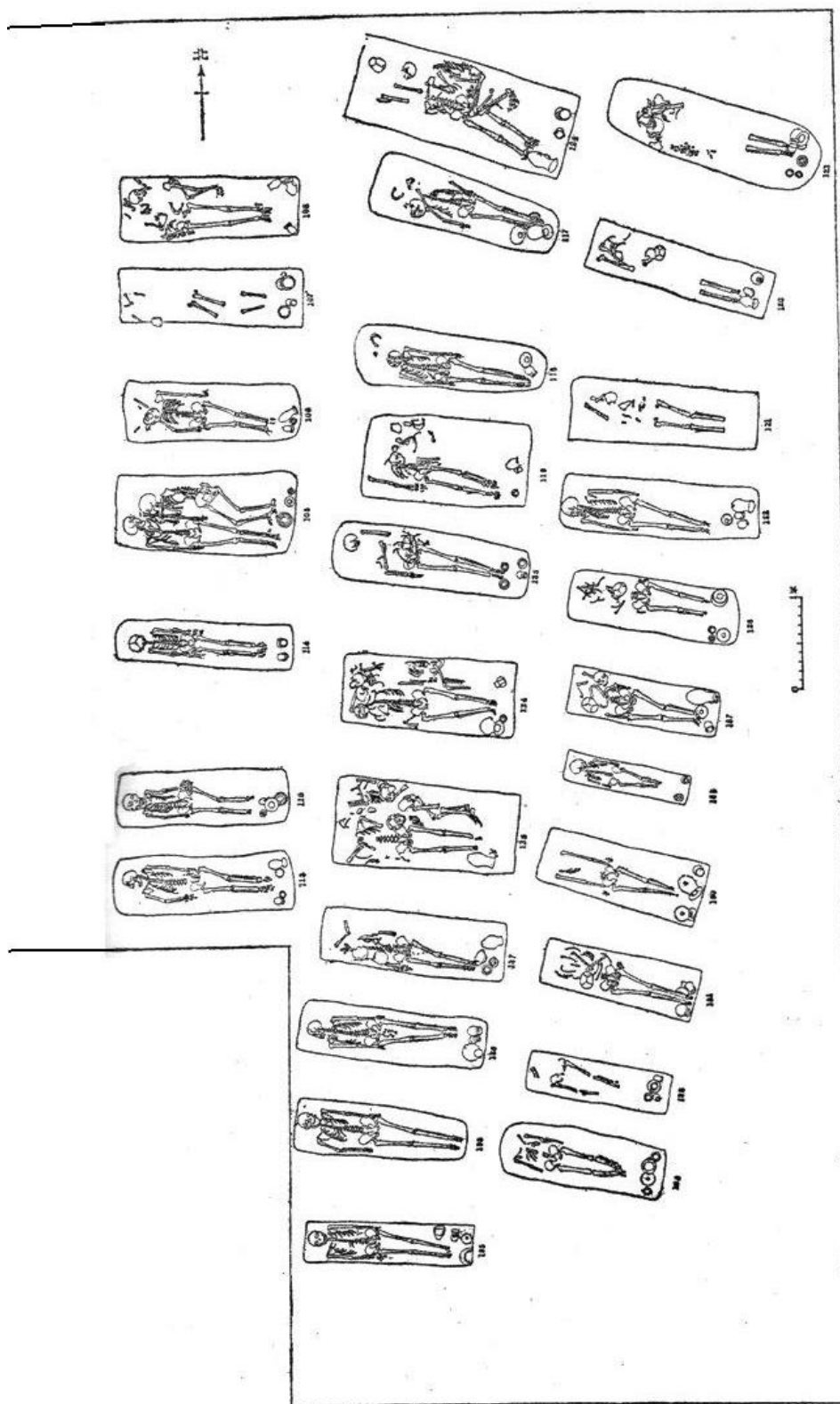


Fig. 050b. Qinweijia, the northern part of the cemetery (after Xie R. J. 1975, 61 Fig. 4).

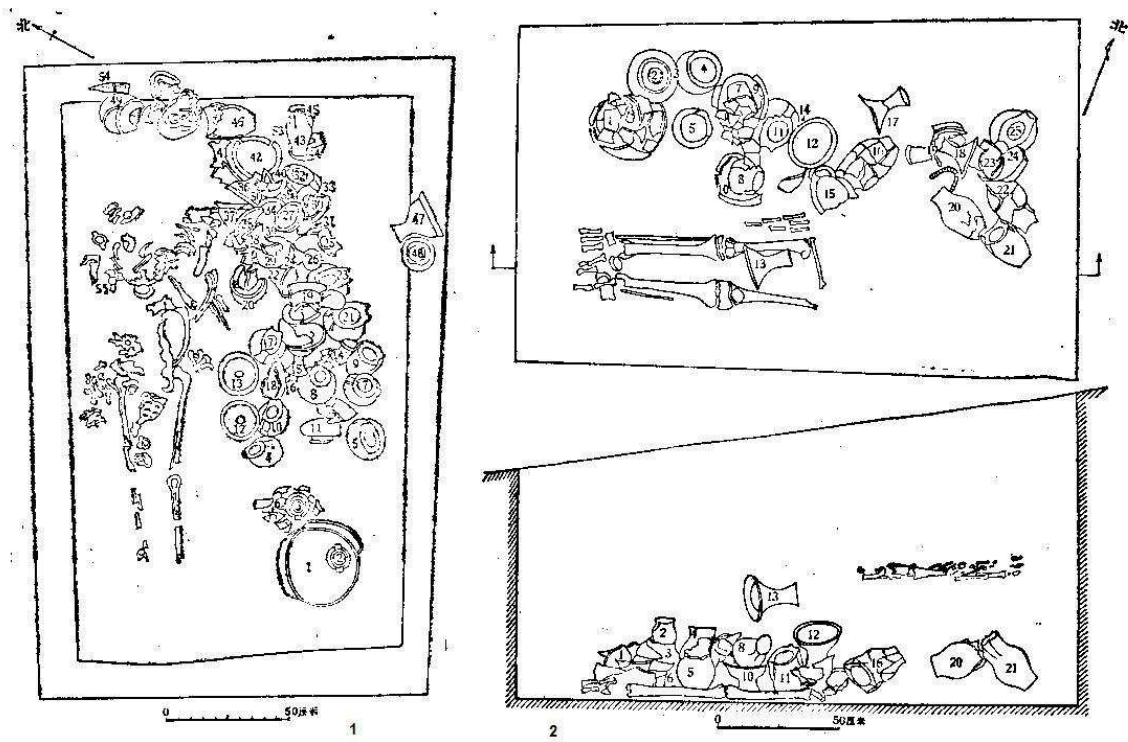


Fig. 051a. Lanqiao, tombs, 1 Tomb M4; 2 Tomb M6 (after GSG 1987, 681 Fig. 6; 680 Fig. 5).

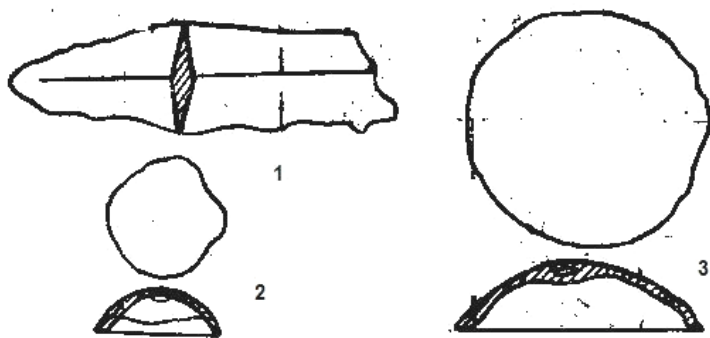


Fig. 051b. Lanqiao, bronze objects, 1 dagger, L 10.3cm; 2,3 bulb, dm 1.6cm.2.3 cm (after GSG et al. 1987,688 Fig.18, 1.3.5).

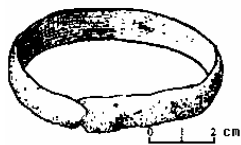


Fig. 052. Siwashan, bronze bracelet (after J. D. Anersson 1943, 251 Fig 62).

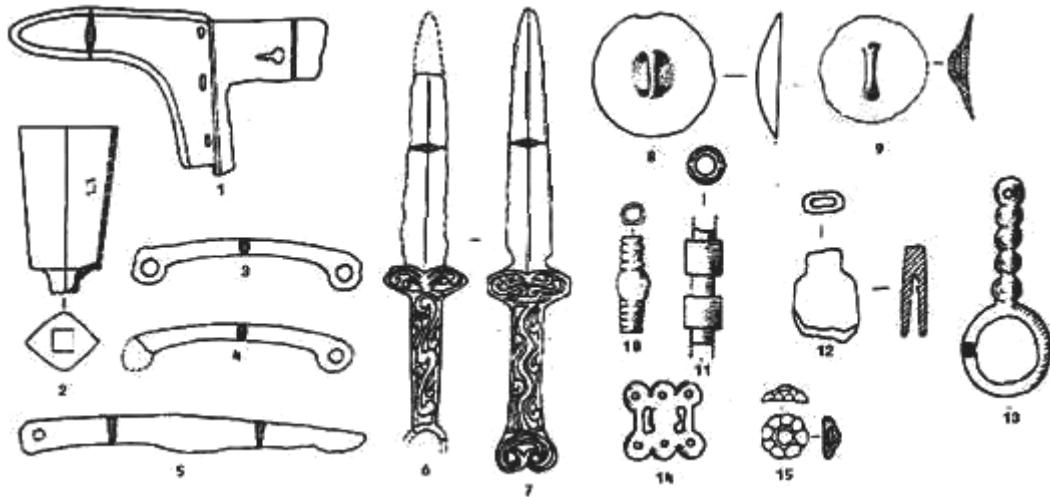


Fig. 053. Shaoping, bronzes objects, 1 dagger, L 18.1cm; 2 Dun, H 9.2cm; 3.4 gag bit, L 13cm.12.3cm; 5 knife, L 19.7cm; 6.7 sword, L 22cm.27cm; 8.9 bulb, dm 6.8cm.4.3cm; 10.11 tube, L 3cm.3 cm; 12 bundle, L 2.4cm; 13 loop, L 5.7cm; 14 ornament, L 2cm; 15 buckle, dm 1.4cm (after ZLB 2000, 45 Fig. 7, 1-7; Fig. 8, 1-8).

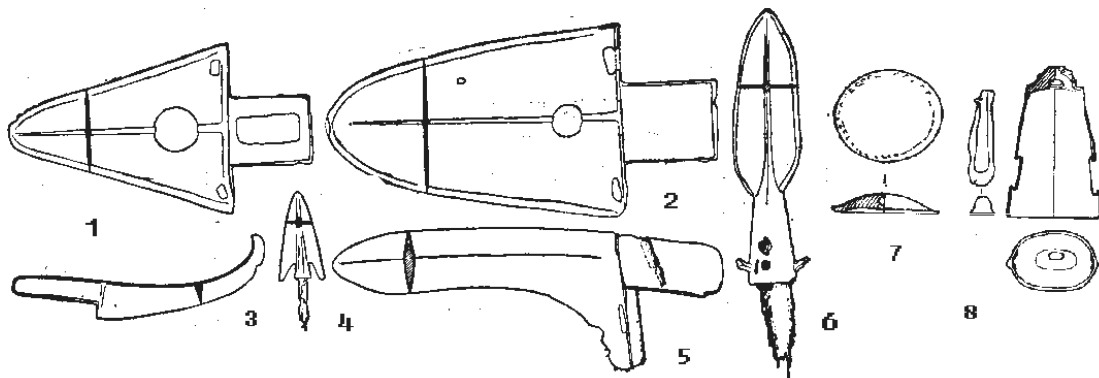


Fig. 054. Xujianian, bronze objects, 1.2.5 dagger, L 16.7cm.21.5cm.21.5 cm; 3 knife, L 14cm; 4 arrowhead, L 7.3cm; 6 spear, L 15cm; 7 bulb, dm 3cm; 8 bell, L 4.8cm (after ZHSKYJ 1982, 558 Fig. 4, 1-6; Fig. 5, 1-3).

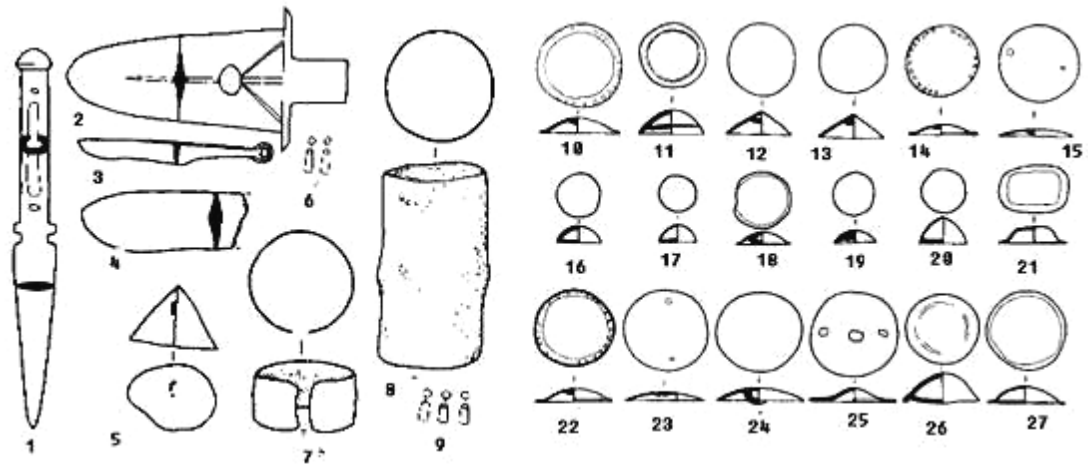


Fig. 055a. Jiuzhan, bronzes objects, 1 sword, L 11.2cm; 2-4 dagger, L 17-18cm (4 is collected); 3 knife, L 116cm; 5 bell, dm 5.4cm; 6.9 tube, L1.3cm.0.9cm; 7.8 armlets, L 2.8cm.11.2cm; 10-27 bulb, dm 1.3-3.5cm (after Wang/Shui 1997, 437 Fig. 93, 1-9; 438 Fig. 094, 1-18).

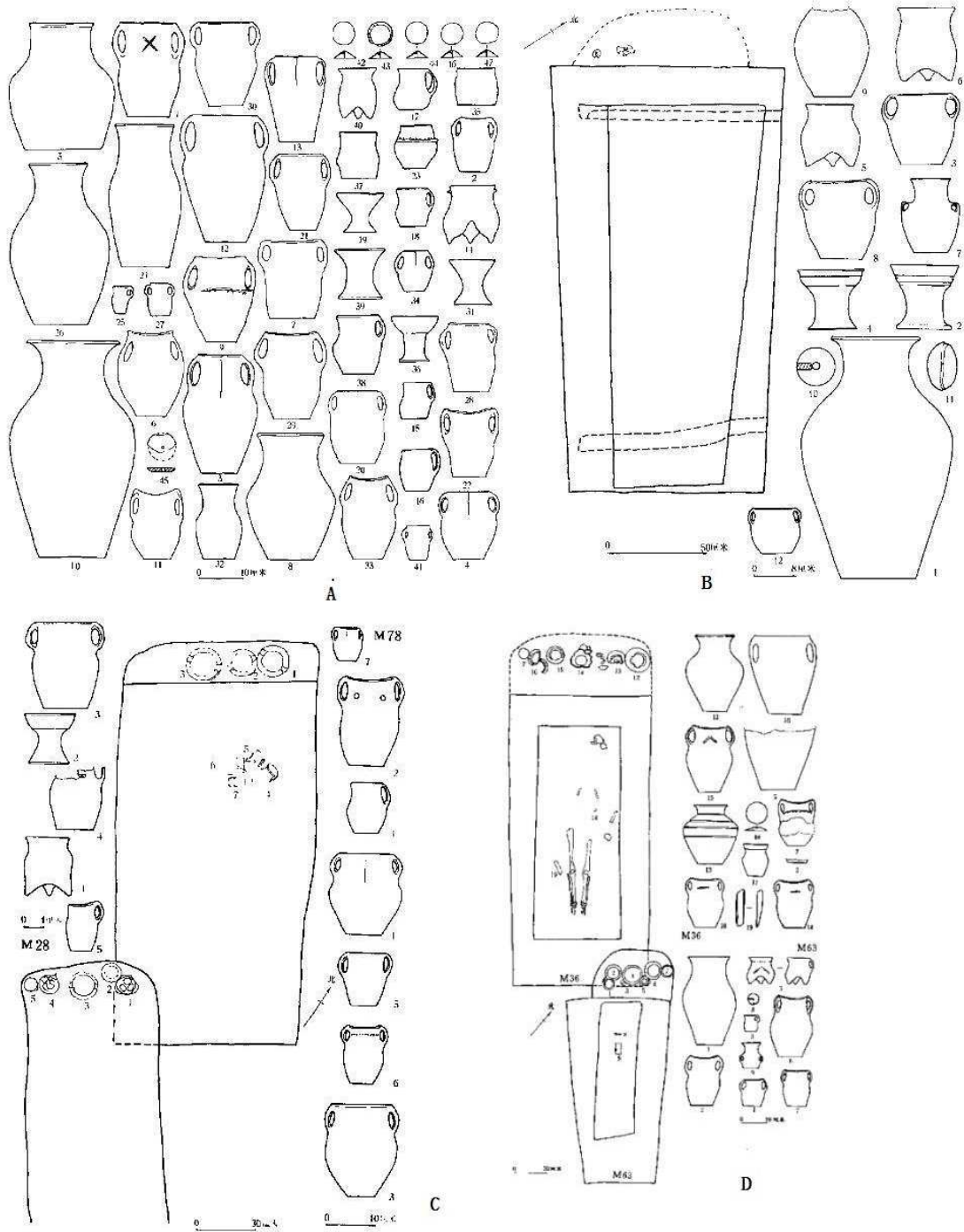


Fig. 055b. Jiuzhai, tombs: A M3; B M17; C M28 and M78; D M36 and M63 (after Wang/Shui 1997, 359 Fig. 39; 360 Fig. 40; 361 Fig. 41; 362 Fig. 42).

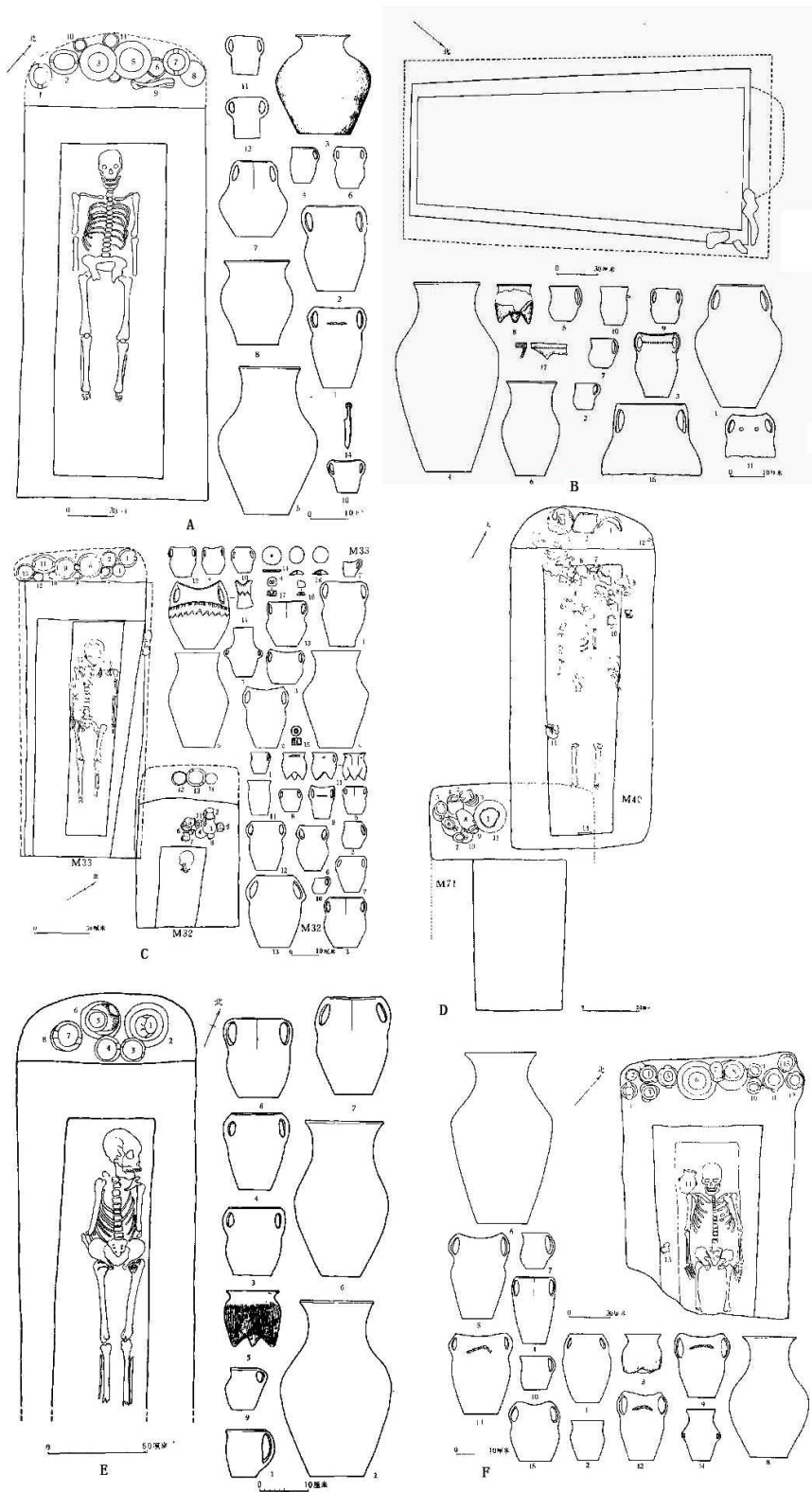


Fig. 055c. Jiuzhan, tombs: A M11; B M19; C M32 and M33; D M40 and M71; E M47; F M1 (after Wang/Shui 1997, 368 Fig. 48; 371 Fig. 51; 363 Fig. 43; 364 Fig. 44; 367 Fig. 47; 372 Fig. 52).

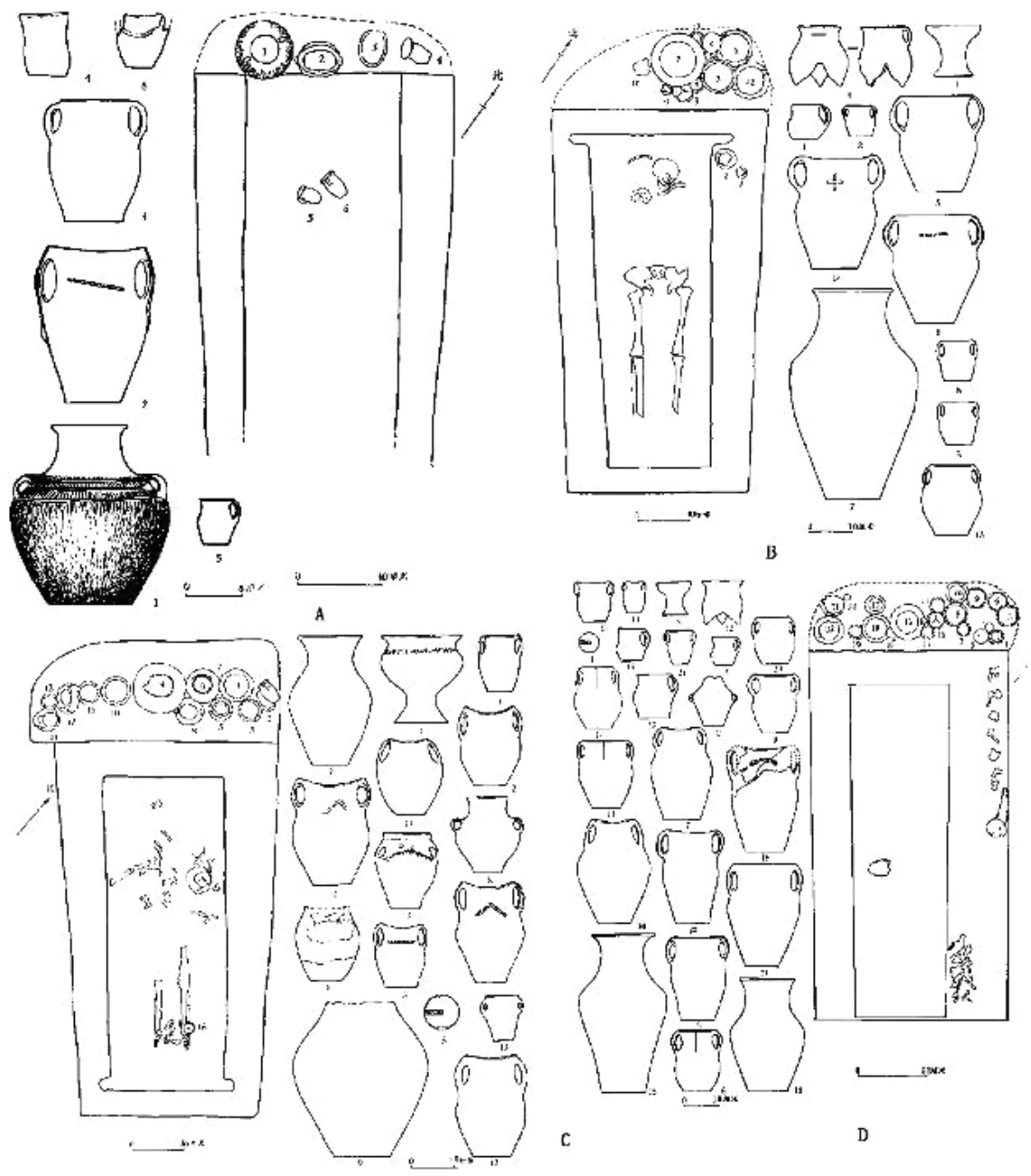


Fig. 055d. Jiuzhan, tombs: A M55 B M59; C M64; D M11 (after Wang/Shui 1997, 366 Fig. 46; 369 Fig. 59; 374 Fig. 64; 370 Fig. 50).

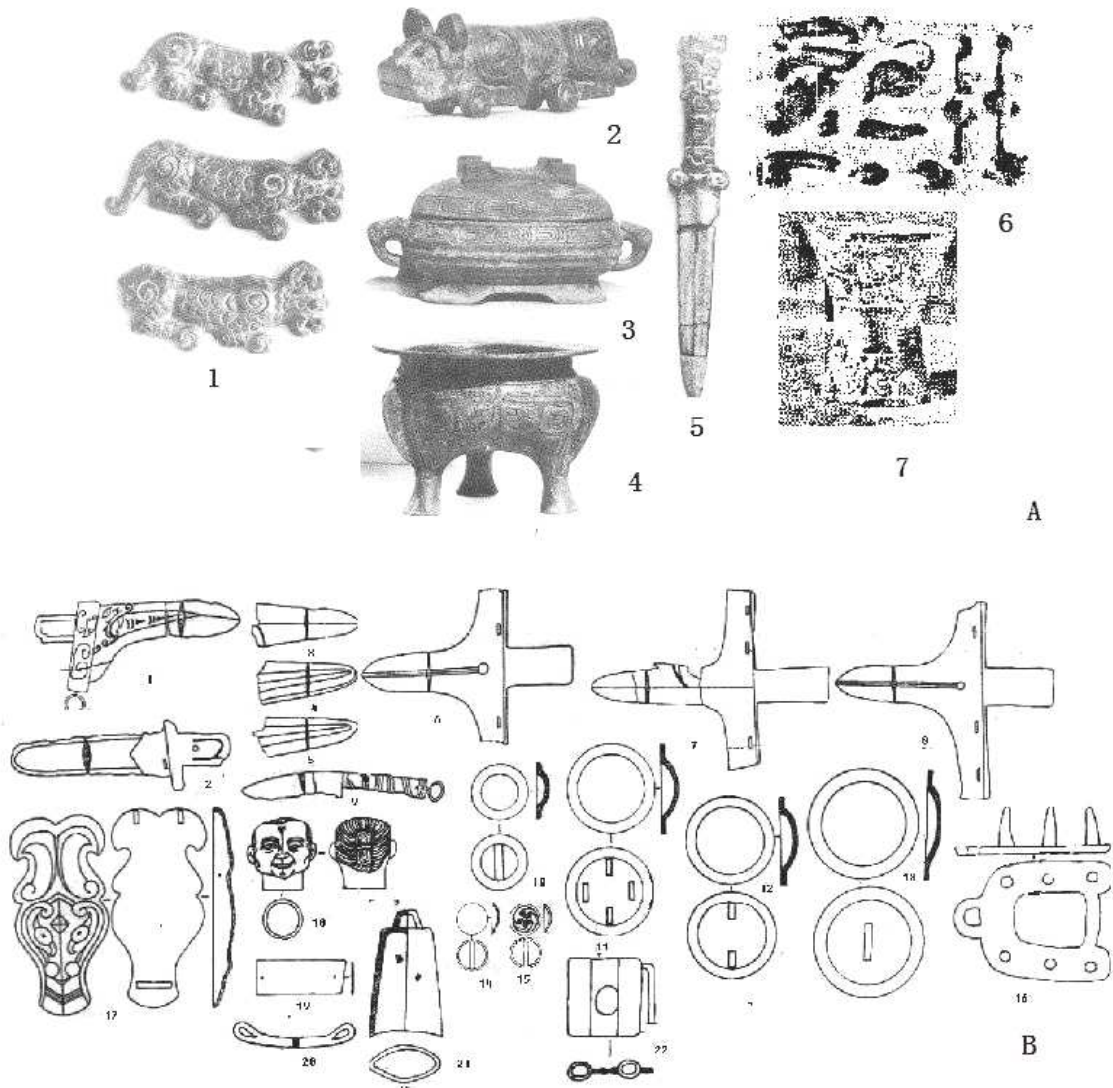


Fig. 056. Bronze objects in the Western Zhou style, A from Yu; B from Jiao (after Xu/Liu 1985, Plate 5, 1-5; 351 Fig. 6; Fig. 5; QYB 1989, 25 Fig. 2, 1.10.4.5.6.2.8.11.7; 26 Fig. 3, 2.5.13.19.6.14.3; 25 Fig. 2, 2; 26 Fig. 3, 1.7.11.18.12).

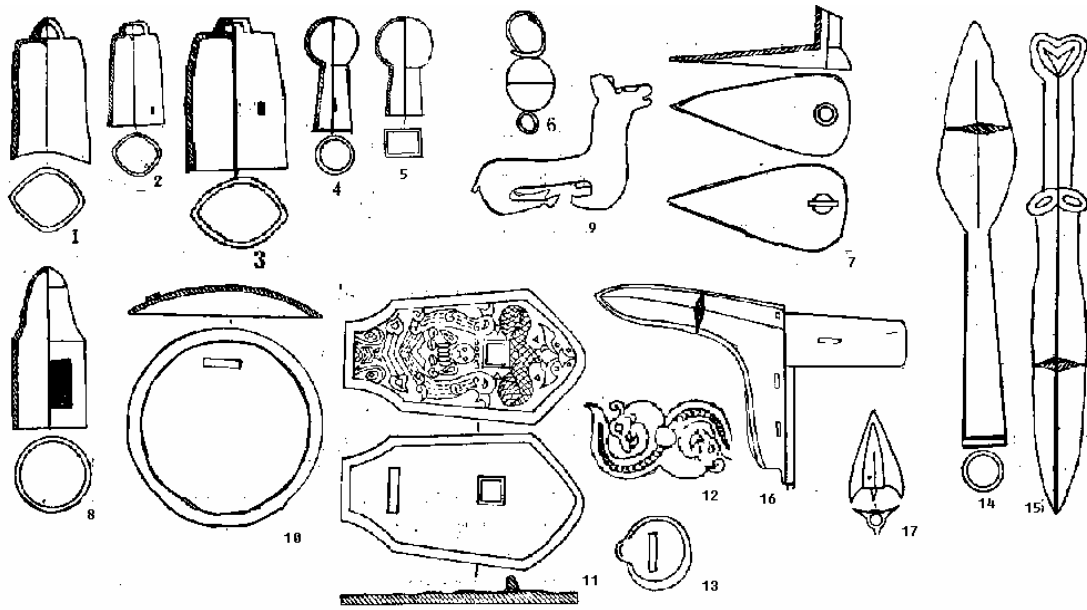


Fig. 057. Yuanjia, bronze object, 1-5 bell, H 9.5cm.4.5cm.16cm.7cm.4.5cm; 6 silver earring H 5cm; 7 tube, L 10.5-12.5cm; 8 chariot fitting, L 11cm; 9 deer, L 6.1cm; 10 horse head ornament, dm 12.5cm; 12 ornament, L 8cm; 13 buckle, dm 2.5cm; 14, iron spear, L 28cm; 15 sword, L 15.5cm; 16 dagger, L 20.3cm; 17 arrowhead, L 3.5cm (after Liu /Xu 1988, 414 Fig. 2, 1.2.3.4.8.6.7.5.9.10.11.12.13.14.15; 416 Fig. 7, 2).

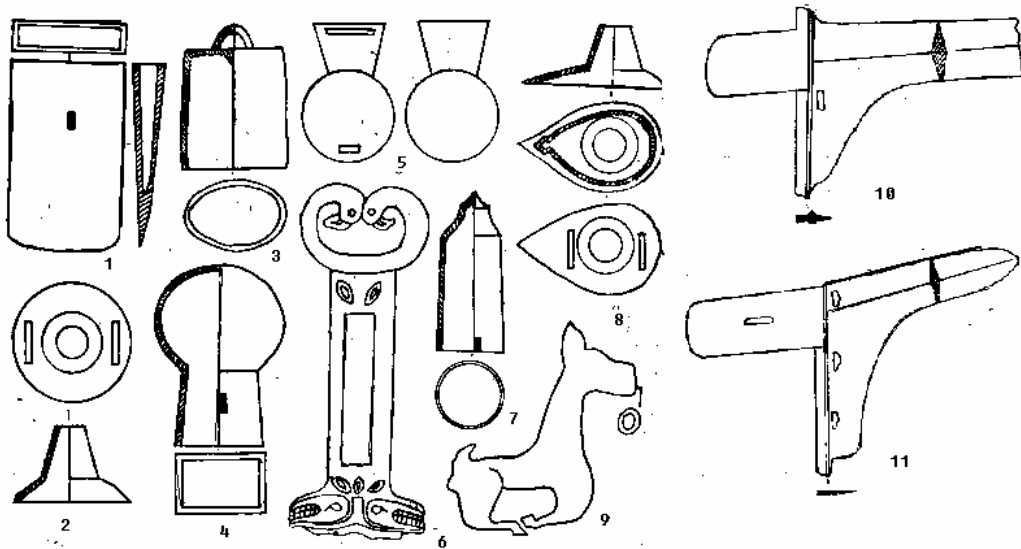


Fig. 058. Houzhuang, bronze objects, 1 adze, L 6.2cm; 2.8 tube, H:2.6cm.9.2cm; 3.4 bell, H 9.5cm.6cm; 5 Dangu, H 6cm; 6 iron handle of sword, L 9.6cm; 7 chariot fitting, L 9.6cm; 9 deer, H 7cm; 10.11 dagger, L 14.9cm.18.5cm (after Liu/Xu 1988, 415 Fig. 5; 416 Fig. 7, 1; 421 Fig. 19, 2).

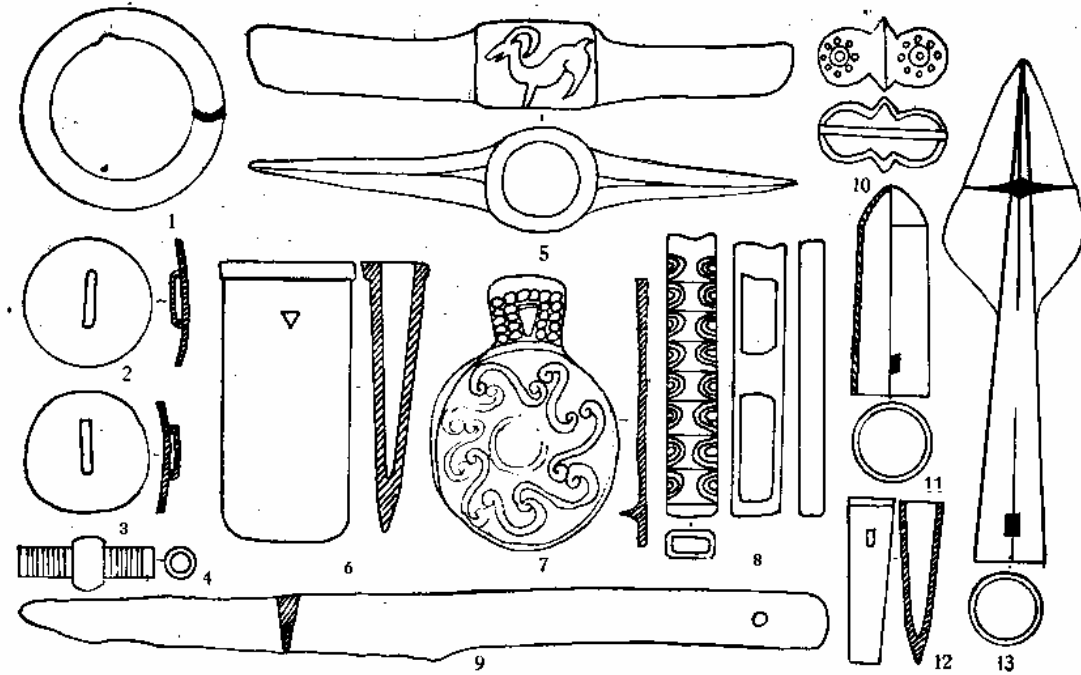


Fig. 059. Miaoqu, bronze objects, 1 loop, dm 5.2cm; 2.3 bulb, dm: 2.5-4.9cm; 4.8 tube, L 3.5cm.7.4cm; 5 hack, L 14.3cm; 6 adze, L 7.2cm; 7 belt ornament, H 7cm; 9 knife, L 20.8cm; 10 ornament, L 3.4 cm; 11 H 11cm; 12 chisel, H 43cm; 13 spear, L 12.9cm (after Liu/Xu 1988, 417 Fig. 8).

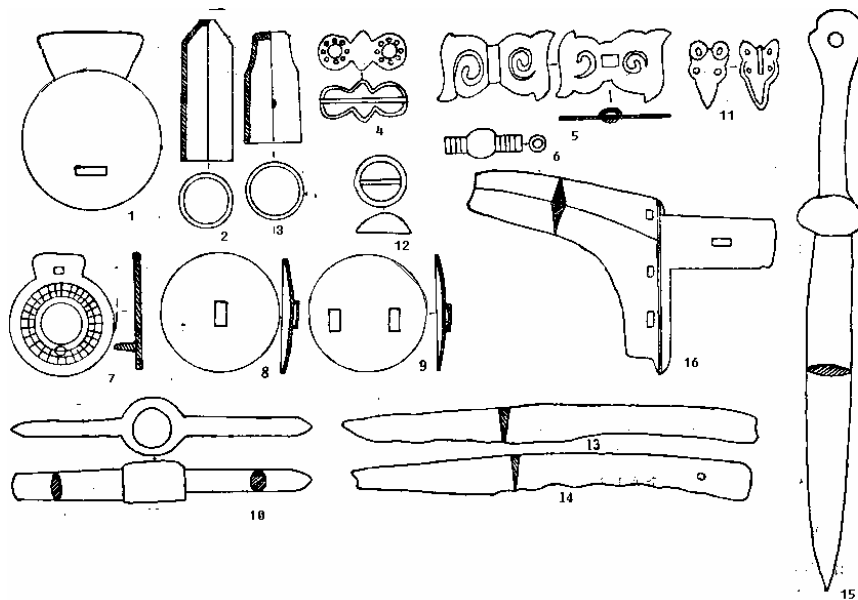


Fig. 060. Hongyan, bronzes objects, 1 Danglu, H 7.5cm; 2.3 H 11.8cm.9cm; 4.5 ornament, L 3.5cm.4.8cm; 6 tube, L 3.5cm; 7 belt ornament, L 5cm; 10 hack, L 12.6cm; 11 ornament, L 3cm; 12 buckle, dm 2.3cm; 13.14 knife, L 16.6cm.17.1cm; 15 sword, L 24.4cm; 16 dagger, L 17.3cm (after Liu/Xu 1988 418, Fig. 10).

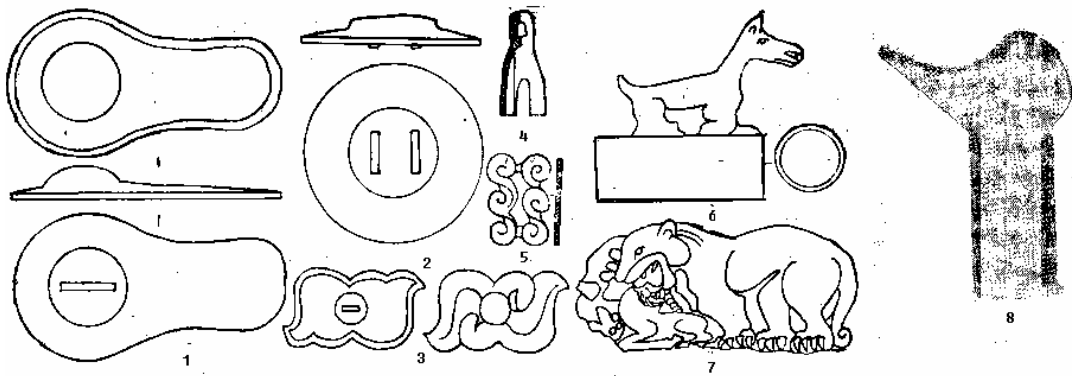


Fig. 061. Wujiagouquan, bronze objects, 1 bulb, L 5.2-3.5cm; 2 bulb, dm 6.4cm; 3 ornament, L 5.2cm; 4 bell, H 3.7cm; 6 deer, H 6cm; 7 belt ornament, L 10.2cm; 8 head of duck, L 7.5cm (after Liu/ Xu 1988, 419 Fig. 12; Fig. 13).

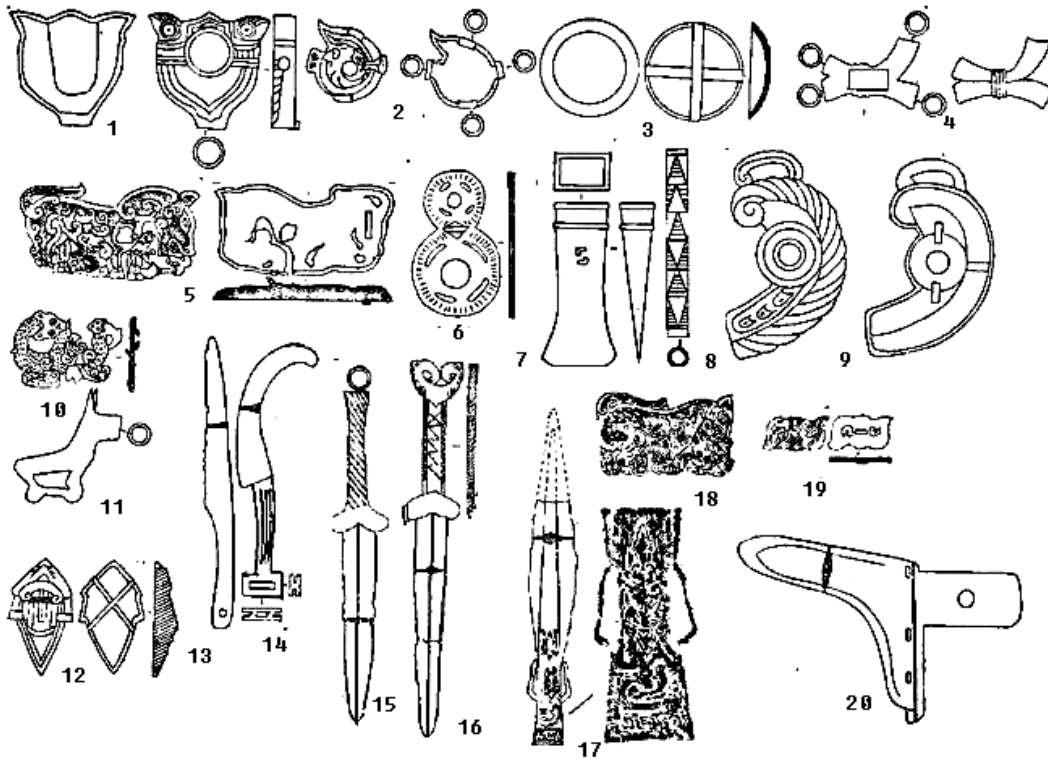


Fig. 062. Bronze objects, 1-13.20 from Qingyang region; 14.15 from Mazhai; 16.17 from Ligou; 18.19 from Tatou; 1 head of bird, L 6.3cm; 2.4.9.12 Jieyun, L 3.6cm.5cm.10.5cm.6.1cm; 3 bulb, dm 5.1cm; 5.6 belt ornament, L 9.5cm.7.8cm; 7 axe, L 8.5cm; 8 tube, L 10.1cm; 10 belt ornament, L 4.7cm; 11 deer, H 6cm; 13.14 knife, L 16.7cm.19.2cm; 15.16 sword, L 27.8cm.17.8cm; 17 spear, L 17.7cm; 18-19 ornament, L 10.8cm.5cm (after Liu/Xu 1988, 421 Fig. 18, 1-12; 420 Fig. 15; Fig. 16, 1; Fig. 17, 1-4; 421 Fig. 19, 4).

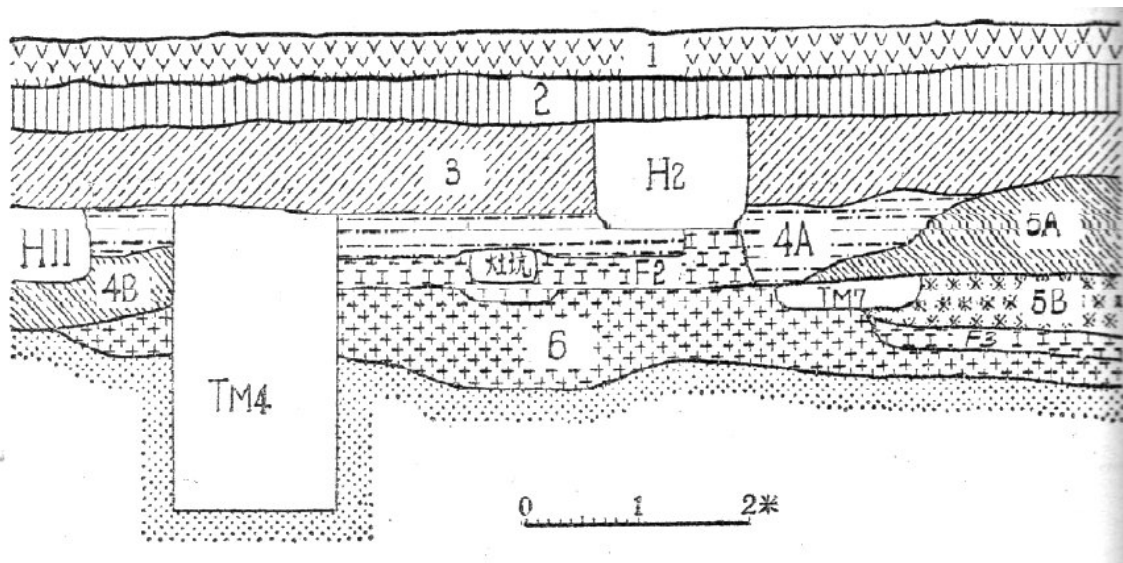


Fig. 063a. Maojiaping, section plan of the east wall of Square T1 and T2, 1 soil; 2 disturbed soil; 3 gray soil; 4A yellowish gray soil; 4B dark gray soil; 5A gray brown soil; 5B yellow soil; 6 red soil (after GSG 1987b, 360 Fig. 2).

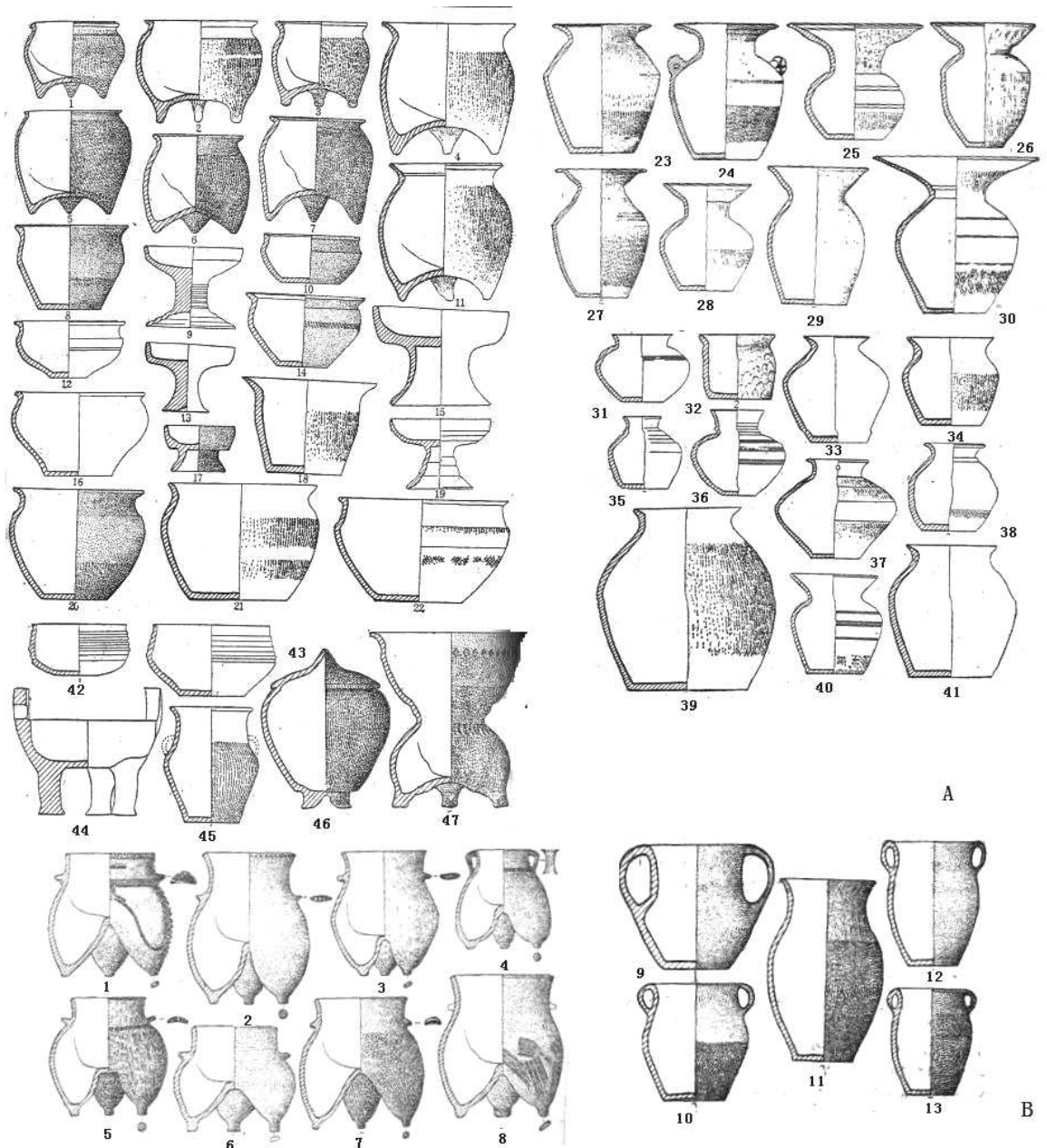


Fig. 063b. Maojiaping, potteries, A Group A; B Group B (after GSG 198b, 379 Fig. 17, 1-22; 382 Fig. 18, 1-8; 383 Fig. 19, 1-11; 384 Fig. 20, 1-6; 390 Fig. 23, 1-8; 391 Fig. 24, 1-5).

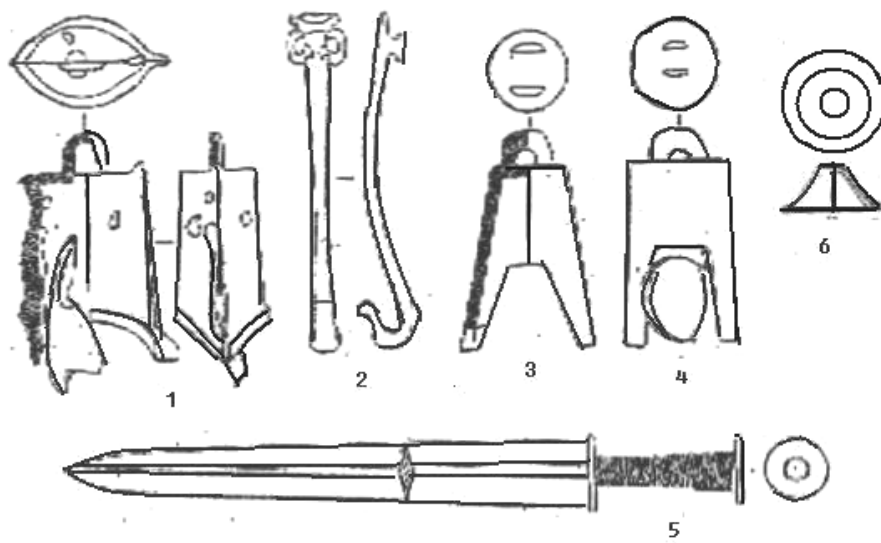


Fig. 063c. Maojiaping, bronzes objects, 1-5 from burials of Group A; 6 from dwellings of Group A, 1.3.4 bell, L 4.5cm.4.2cm.4.2 cm; 2 hook, L 6.6cm; 5 sword, L 38.7cm (after GSG 1978b, 385 Fig. 21, 1.2.5.6.11; 374 Fig. 12, 11).

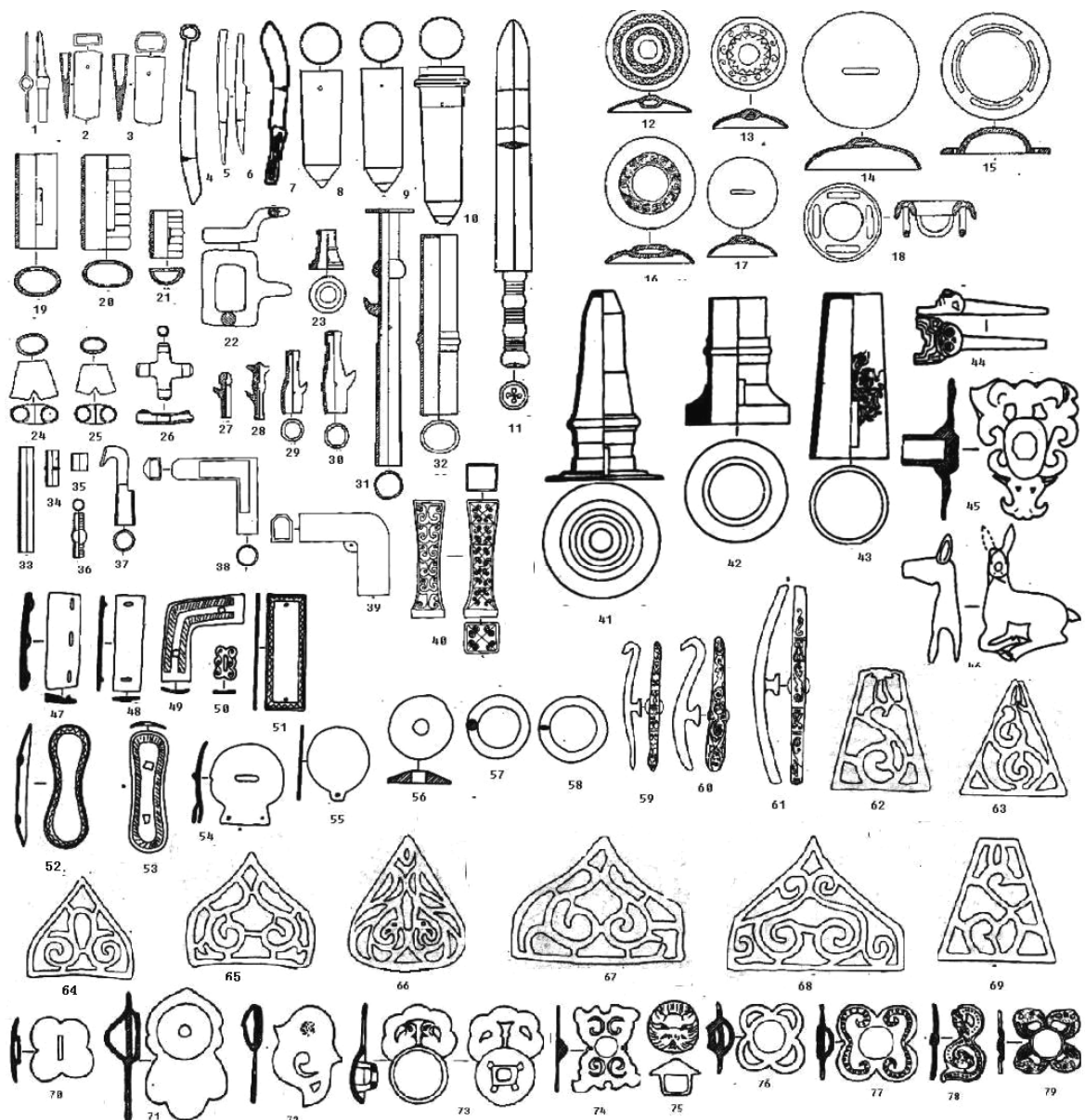


Fig. 064a. Liuping, bronze objects, 1 crane hack, L 12.5cm; 2.3 axe, L 8cm.8 cm; 4-7 knife, L 21cm.16cm.14cm.16 cm; 8-10 Dun, L 15.3cm.14.4cm.19.5cm; 11 sword, L 43cm; 12-17 bulb, dm 4.5-7.6cm; 19-21 horse fitting, H .1-6cm; 22 chariot fitting, H 5.3cm; 23 ornament of axle, H 3.5cm; 24-36 Jieyue, H 2-3.7cm; 27-31 chariot fitting, H 2.6cm.3.4cm.4cm.5.3cm.16.4dm; 32 chariot fitting, H 11.4cm; 33-40 tube, H 1.5-15.5cm; 41-45 chariot fittings, H 9-13.5cm; 46 figure, H 8.3cm; 47-55 plaque, H 2-13.; 56-58 loop, dm 2.3-4.4cm; 59-61 hook, H 10.4cm.10.8cm.15cm; 62-69 hallow-worked plaque, H12-13.8cm; 70-79 buckle, H3.3-8.8cm (after Li/Nan 2003, 5 Fig. 1, 1-6; Fig. 2, 2.1.3.4.5; 6 Fig. 3, 1-21; 8 Fig. 8, 2.5.6.4..1.7.8.3; 7 Fig. 4, 1-5;15 Fig. 6; 13 Fig. 20, 1-9; Fig. 21, 1-6; 14 Fig. 22, 8.7.3.4.1.4.5.6; 15 Fig. 23, 5.1.2.8.8.10.7.3.4.6).

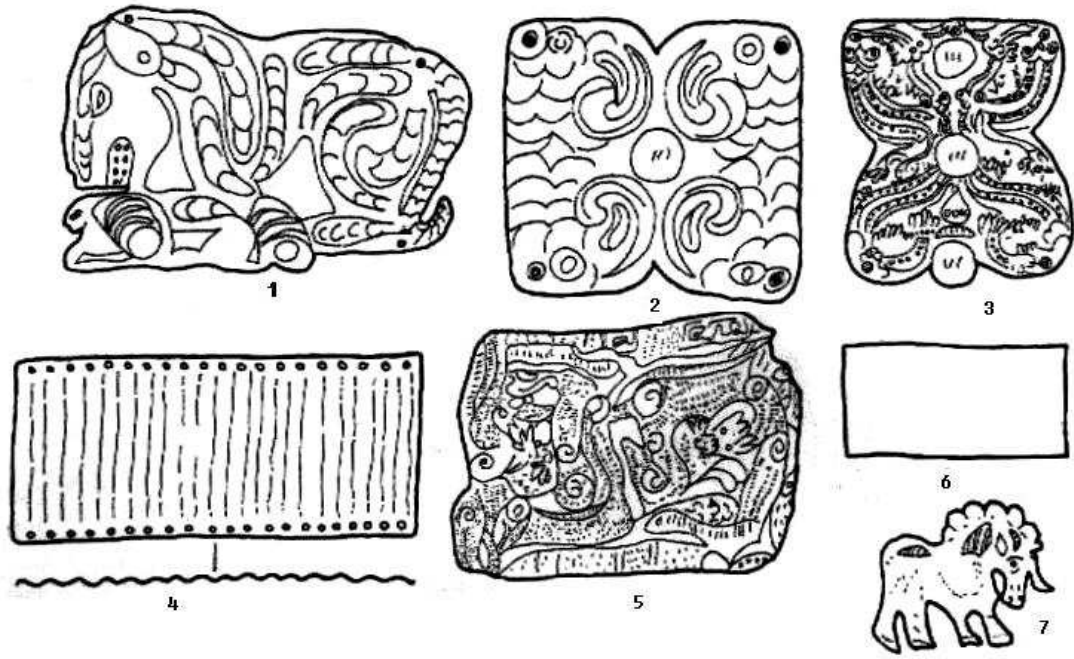


Fig. 064b. Liuping, gold objects, 1-7 ornament, L 3.5-8.4cm (after Li /Nan 2003, 16 Fig. 25, 1-7).

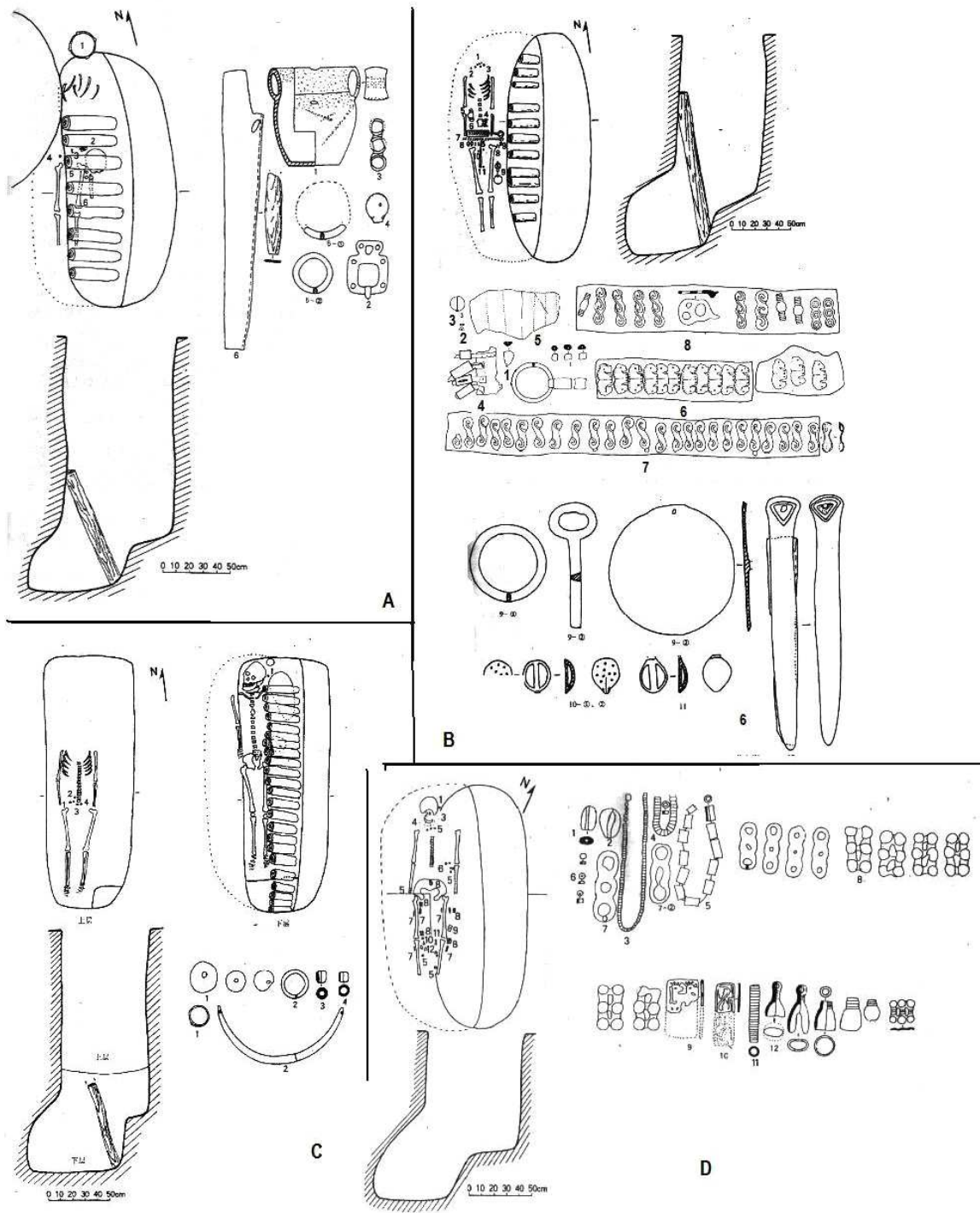


Fig. 065a. Xigang, tombs: A Tomb M194; B Tomb M140; C Tomb M26; D Tomb M365 (adapted from Xigangchaiwangang 2001, 11 Fig. 3; 13 Fig. 5; 14 Fig. 6; 13 Fig. 6; 16 Fig/ 7; 18 Fig. 8).

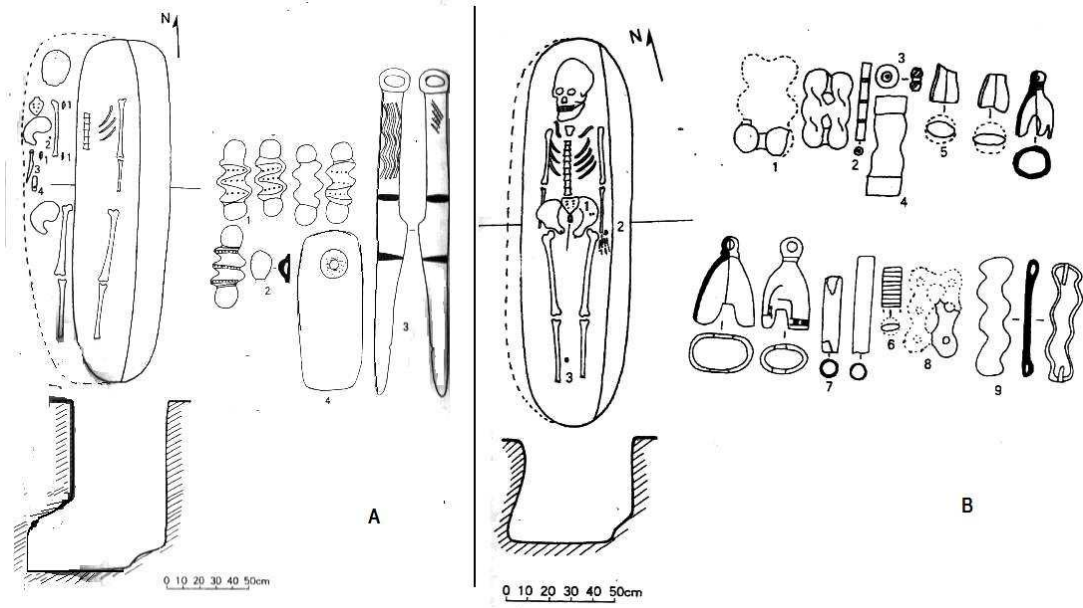


Fig. 065c. Xigang, tombs: A Tomb M429; B Tomb M219 (adapted from Xigangchaiwangang 2001, 25 Fig. 13; 27 Fig. 14).

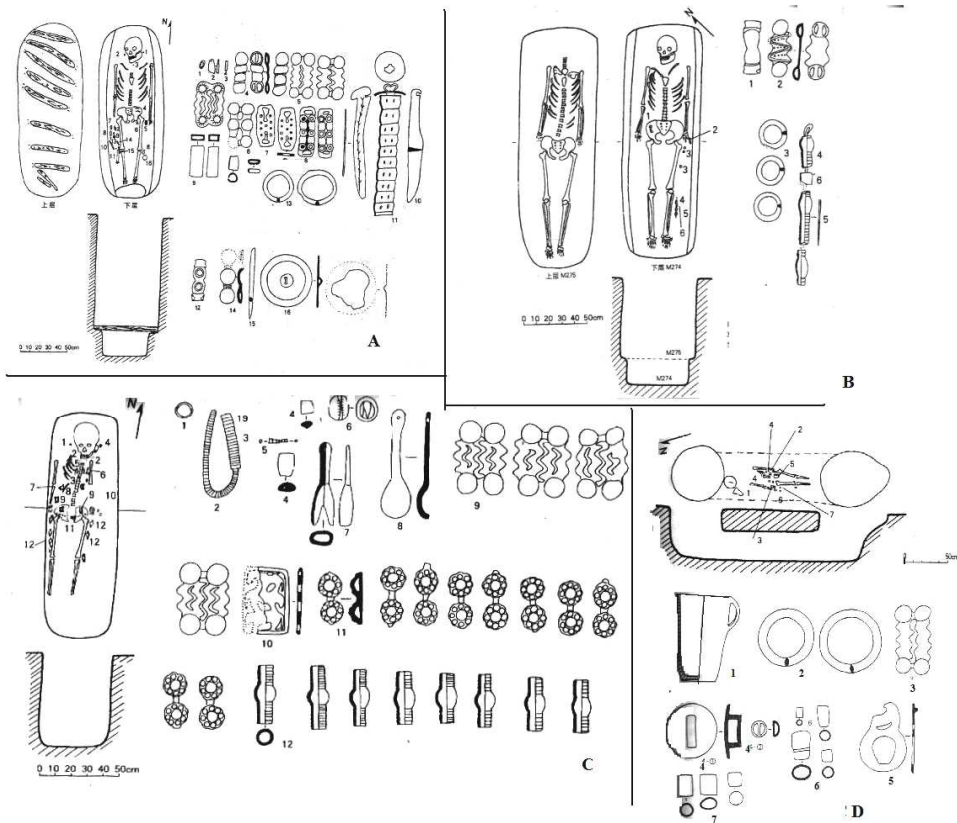


Fig. 065d. Xigang, tombs: A Tomb M15; B Tomb M275; C Tomb M24; D Tomb M442 (adapted from Xigangchaiwangang 2001, 28 Fig. 15; 30 Fig. 16; 33 Fig. 17; 35 Fig. 18).

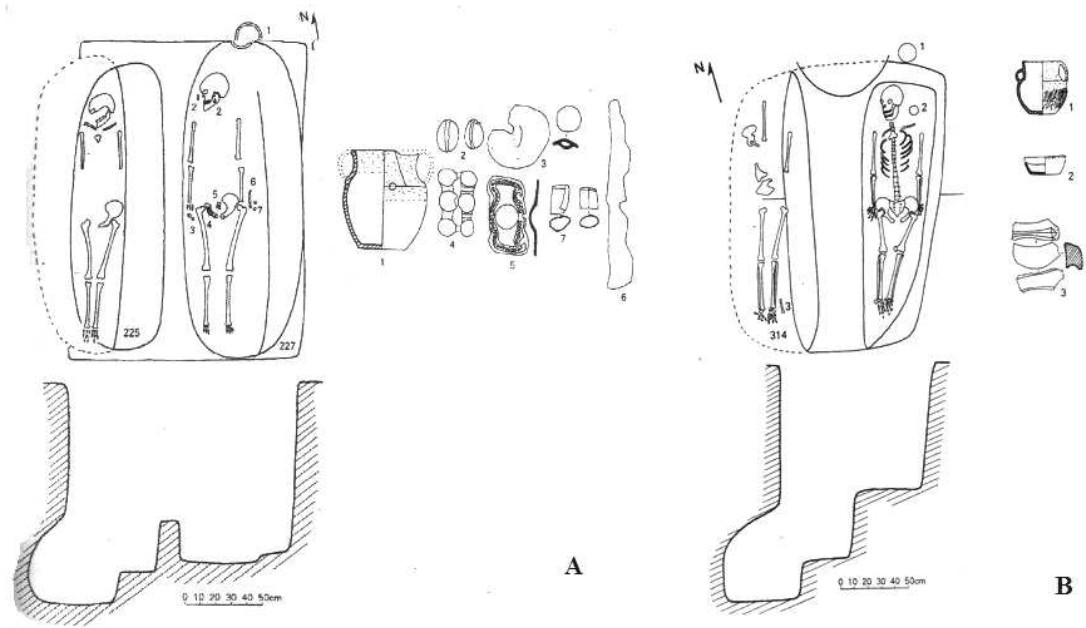


Fig. 065e. Xigang, tombs: A Tomb M225, M227; B Tomb M313, M314 (from Xigangchaiwangang 2001, 39 Fig. 19; 40 Fig. 20).

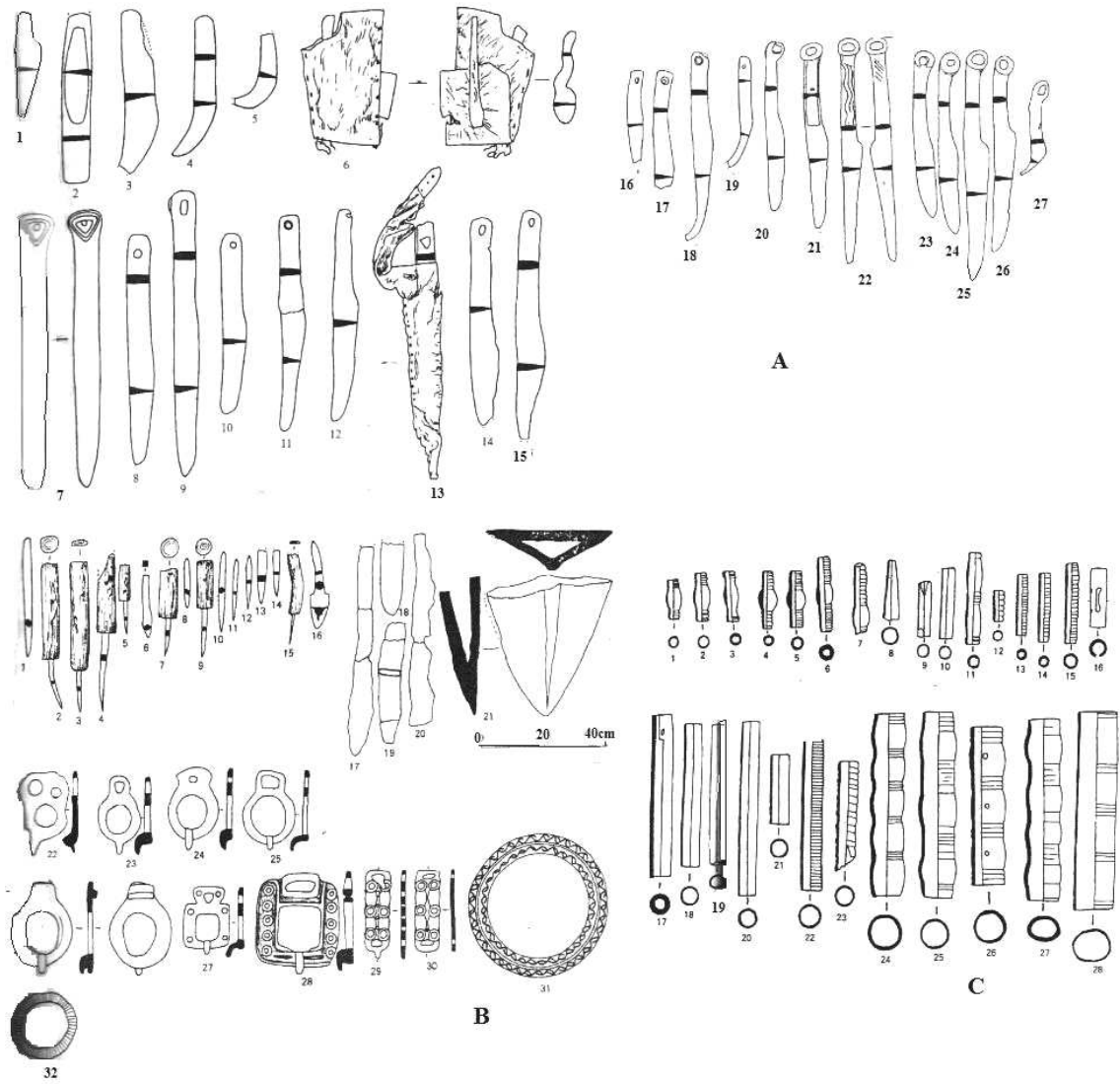


Fig. 065f. Xigang, metal objects: A knife (after Xigangchaiwangang 2001, 61 Fig. 25, 1-15; 62 Fig. 26, 1-12); B 1-16 awl ; 17-20 knives; 21 plough; 22-30 buckle; 31.32 rings (after Xigangchaiwangang 2001, 69 Fig. 27, 1-32); C tubes (after Xigangchaiwangang 2001, 82 Fig. 31, 1-28), B 17-21, iron objects; others, bronze objects.

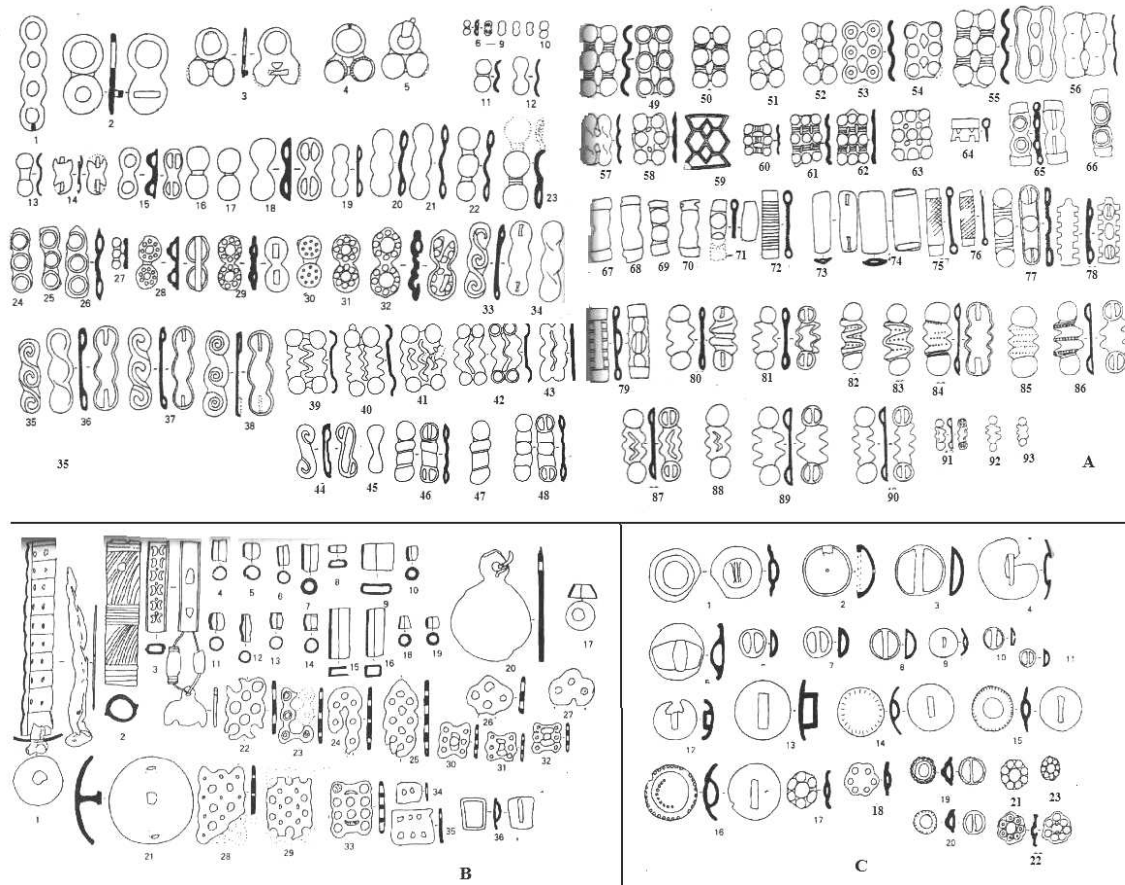


Fig. 065g. Xigang, metal objects: A bead (after Xigang Chaiwangang 2001, 72 Fig. 28, 1-38; 80 Fig. 30, 1-10; 79 Fig. 29, 1-42); B 1-19 tube; 20-35 ornament with holes; 36 ornament (after Xigangchaiwangang 2001,85 Fig. 32, 1-36); C bulb (after Xigangchaiwangang 2001, 92 Fig. 33, 1-23).B19 iron; others, bronze objects.

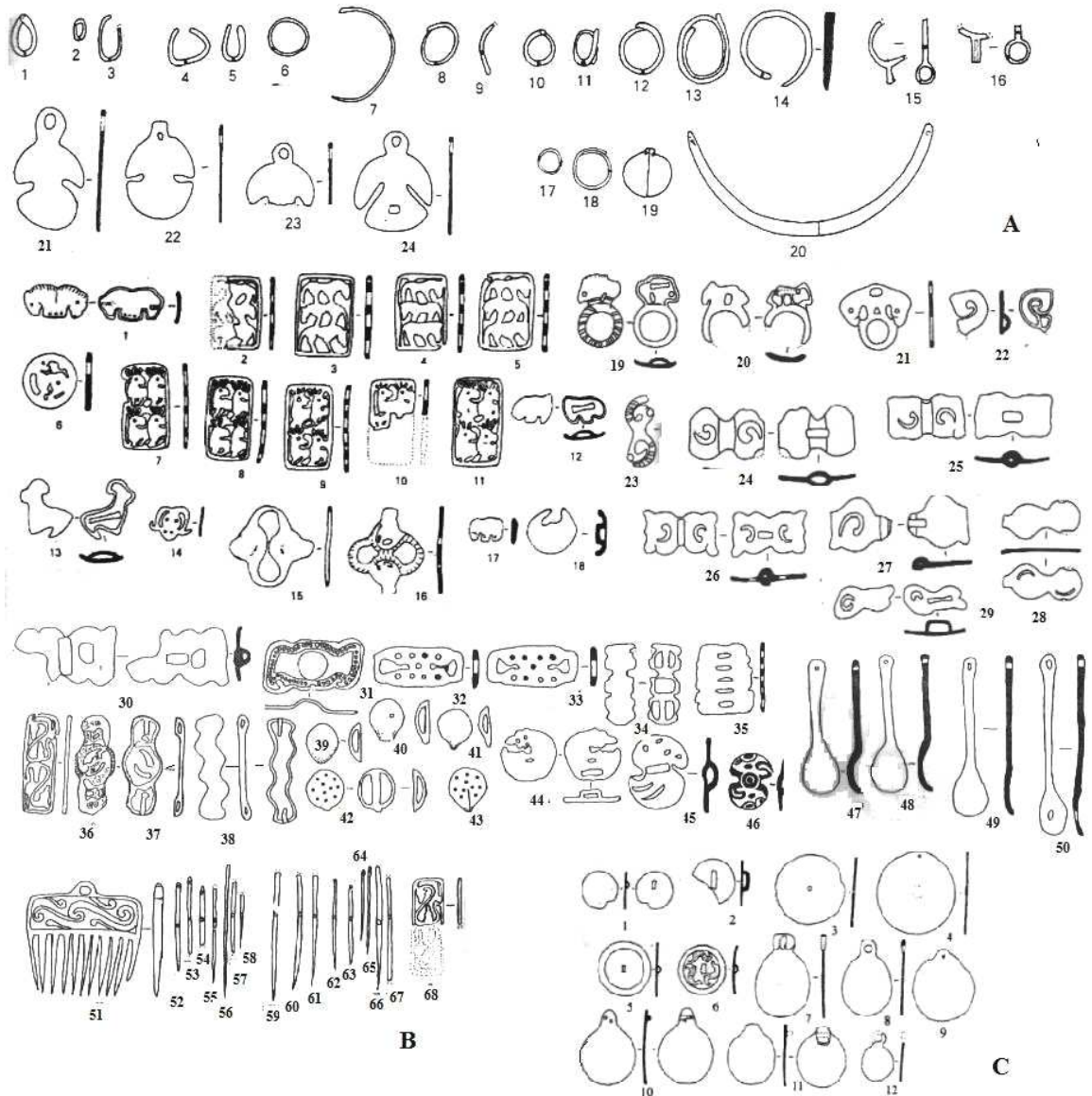


Fig. 065h, Xigang, metal objects: A 1-18 earrings; 19-20 ornament; 21-24 figures of human beings (after Xigangchaiwangang 2001, 93 Fig. 34, 1-20); B 1-46, 68 plaques; 47-50 spoons; 51 comb; 52-67 needles (after Xigangchaiwangang 2001, 95 Fig. 35, 1-18; 96 Fig. 36, 1-11; 100 Fig. 37, 1-39); C mirrors(Xigangchaiwangang 2001, 101 Fig. 38, 1-12). B 17-20, gold objects; others, bronzes.

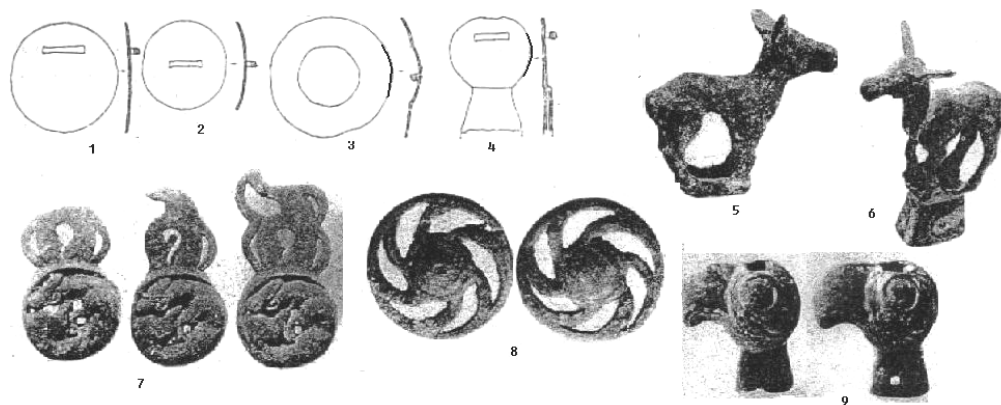


Fig. 066. Yushugou, bronze objects, 1-3 plaque, dm 5.8-7cm; 4 spade plaque, H 6.8cm; 5,6, H 5cm.6.5cm; 7 dog-shaped plaque, H 9-10cm; 8 turbo-shaped plaque, dm 6.8cm (after GSBG 1981, 34 Fig. 1, 2.4.5.6; Plate 5, 1.2.6.5.4).

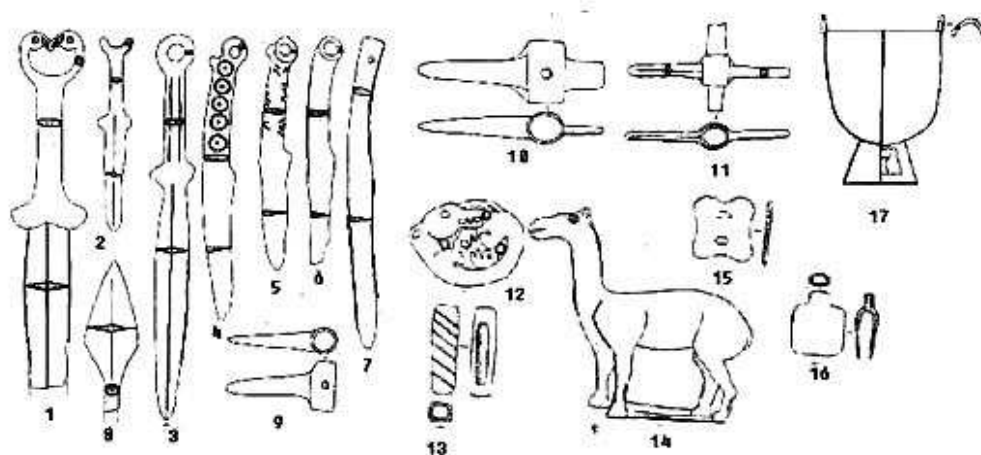


Fig. 067. Qin'an, bronze objects, 1-3 swords, L 21cm.18cm.22.7cm; 4-7 knife, L 16.6cm.13.7cm.14.5cm.18.3cm; 8 spear, L 9cm; 9-11, crane hook, L 6.5cm.12.1cm.9.9 cm; 12 plaque, dm 2.8-3.8cm; 13 tube, L 2.9cm; 14 sheep, H 6.8cm; 15.16 ornament, L 2cm.2.7cm; 17 Fu- cooking ware, L 18cm (after Xu/Guo 1986, 40 Fig. 1, 1-11; 41 Fig. 2, 1-5; 42 Fig. 3).

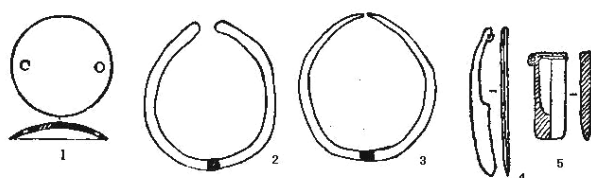


Fig. 068. Bronze objects, 1-3 from Xinzhuangping; 4-5 from Xinglin; 1 bulb, dm 2cm; 2,3 bracelets, dm 6.4cm.6.3 cm; 4 knife, L 22cm; 5 axe, L 13cm (after GSB 1996, 51 Fig. 6, 1.2.4; Yang Y. M. 1985, 978 Fig. 2, 10.11).

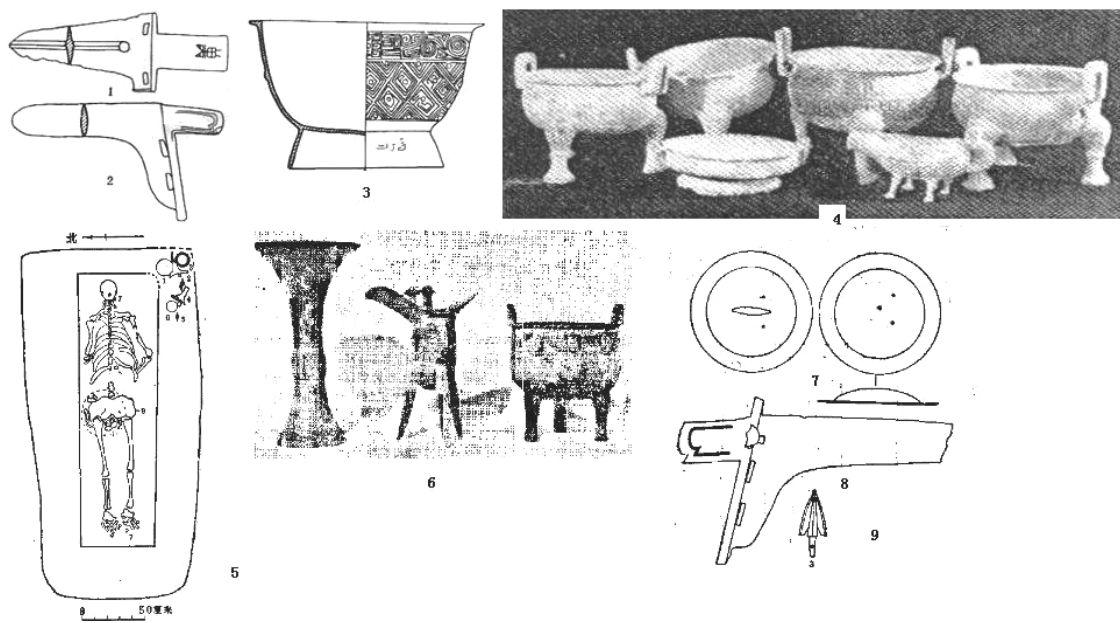


Fig. 069. Bronze objects in the the Central Plains style found in the Gansu Province, 1-3 from Yujiawan; 4 from Tianshui; 5-9 from Miaozui (after GSG 1986, 5 Fig. 1-3; Wang B. Q. 1998, 82 Fig. 1; Xu J. C. et al. 1985, 853 Fig. 1; 854 Fig. 2; Fig. 3, 1-3).

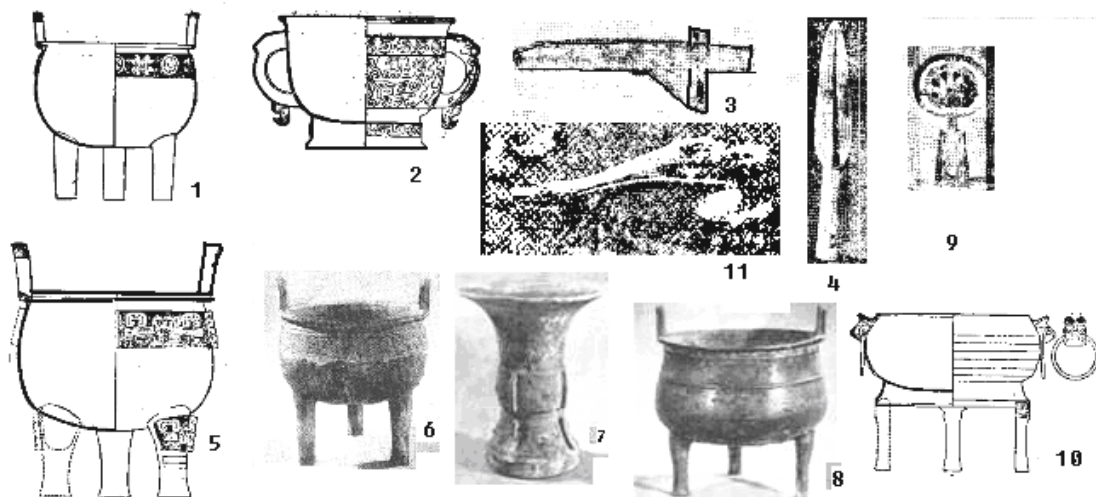


Fig. 070. Bronze objects in the Central Plains style, 1-4 from Yaojiahe; 5-7.11 from Dongshan; 8-10 from Xiling (after GSBG 1976, 41 Fig. 4, 1.2; 40 Fig. 2, 3.4; 41 Fig. 4, 4; Plate 6, 2.5.11; 40 Fig. 2, 5; 41 Fig. 4, 1).

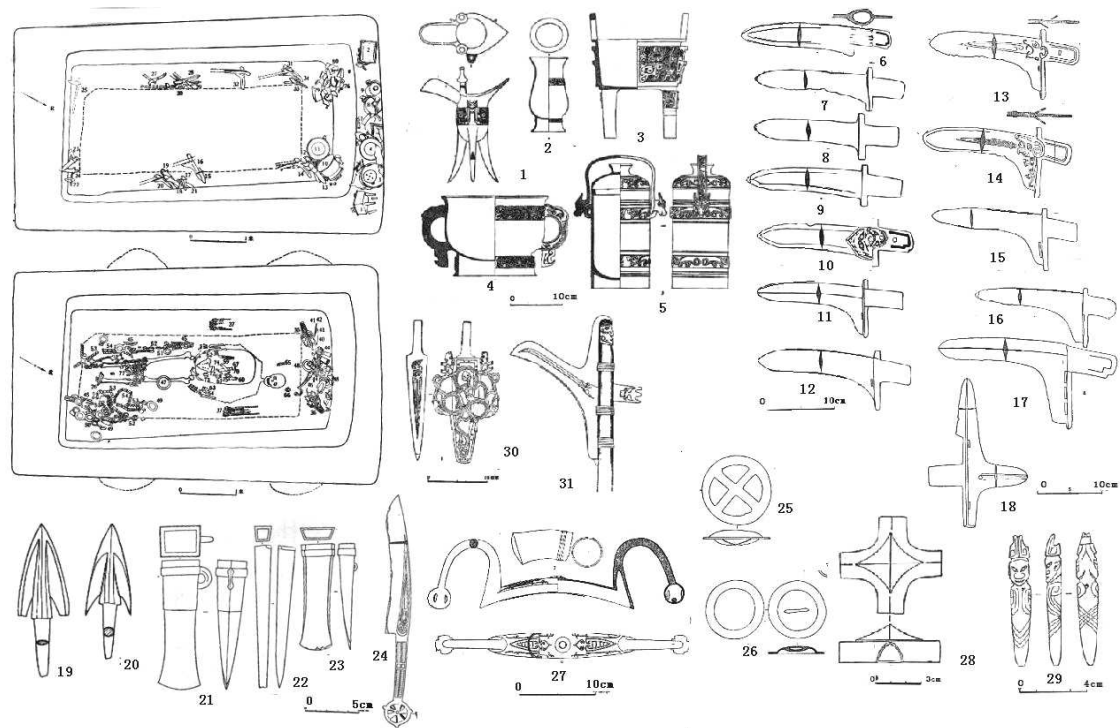


Fig. 071a. Baicaopo, burial goods of Tomb M2, 1-28 bronze; 29 jade, 19,20, L 6.2cm.4.7cm (after Chu S. B. 1977, 107 Fig. 7, 1-5; 111 Fig. 10, 2.5.7.8.10.13.14; 113 Fig. 11, 1.2.5.6.8.10; 115 Fig. 14, 1.2; 116 Fig. 15, 1-3.6; 117 Fig. 16, 4.5.9; 118 Fig. 17, 6; 120 Fig. 19, 2; 115 Fig. 13, 1.3).

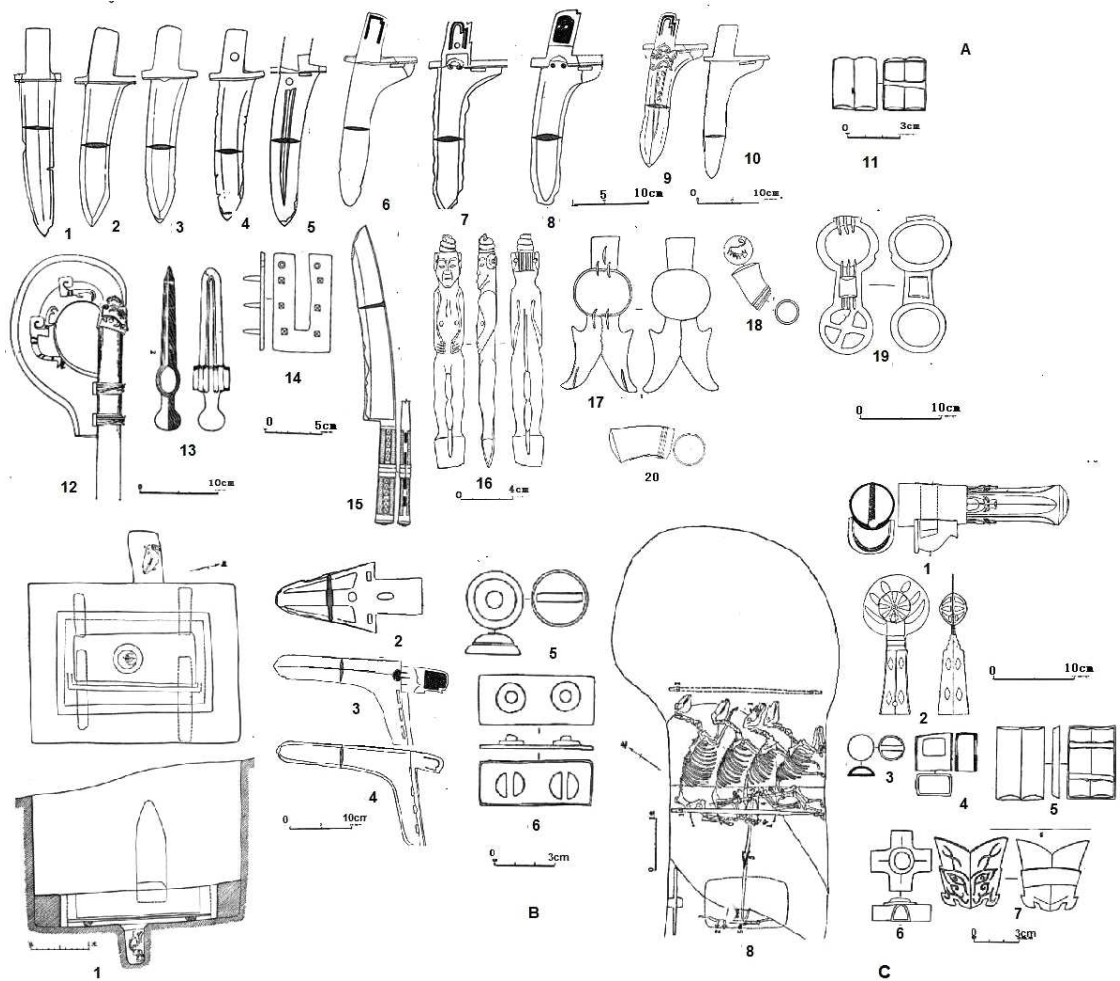


Fig. 071b. Baicaopo, tombs and burial goods, A Tomb M1; 2 Tomb M7; C chariot pit (A after Chu S. B. 1997, 111 Fig. 10, 3.4.6.9.11.12.15.16; 113 Fig. 11, 7.9; 118 Fig. 17, 4; 115 Fig. 13, 4.2; 116 Fig. 15, 4.5; 120 Fig. 19, 1; 117 Fig. 16, 1.3.6.7; B after Chu S. B. 100 Fig. 2; 111 Fig. 10, 1; 113 Fig. 7.9; 118 Fig. 17, 2.5; C after Chu S. B. 1997, 105 Fig. 6; 117 Fig. 16, 2.9; 118 Fig. 17, 1.3.7.8.9).

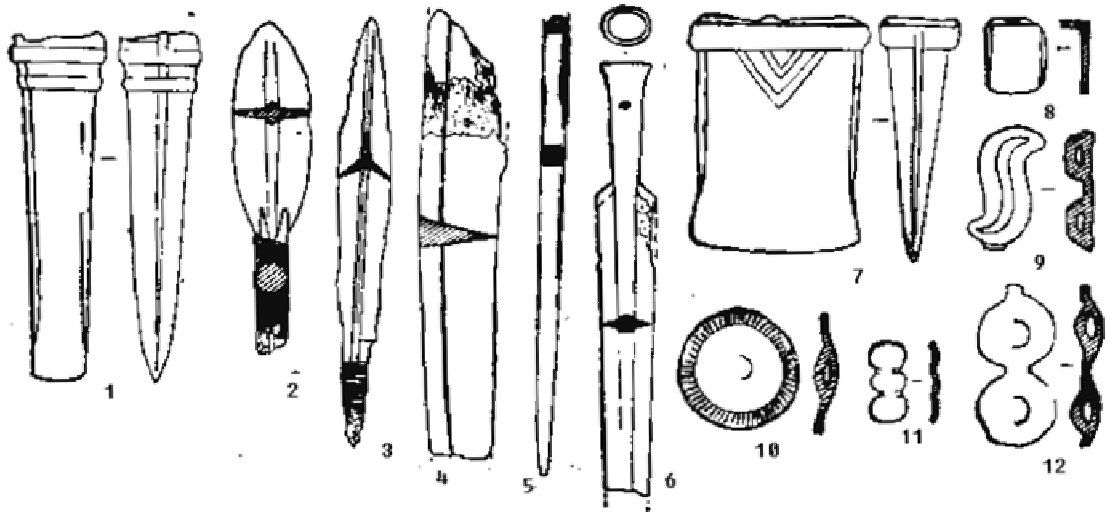


Fig. 072. Longtoushan, bronzes objects, 1 chisel, L 7.5cm; 2.3 arrowhead, L 7cm.9.2cm; 4 knife, L 9.6cm; 5 awl, L 9.6cm; 6 sword, L 30.5cm; 7 axe, L 5.2cm; 8 ornament, H 1.6cm; 9 belt ornament, H 2.7cm; 10 bulb, dm 2.6cm; 11.12 buckle, L 1.7cm.3.4cm (after NMGY et al. 1991, 709 Fig. 11, 1-5; Fig. 12, 1; Fig. 11, 6.9.8.7.10.11).

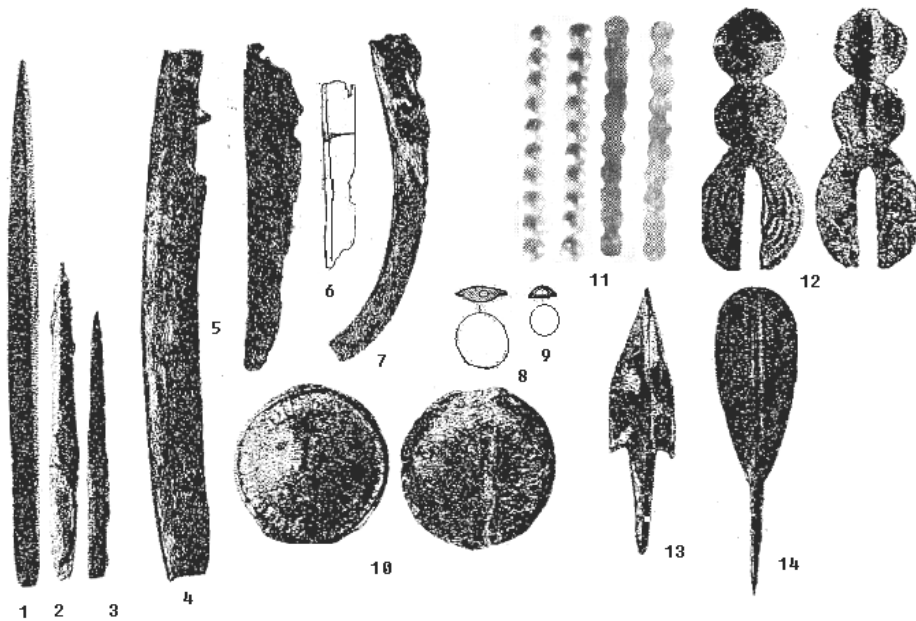


Fig. 073. Xiajiadian, bronze objects, 2 awl, L 9.4cm; 4-7 knife, L 6-13cm; 8-10 buckle, dm 3-3.3cm; 11.12 bead ornament, L 4.5-4.7cm; 13.14 arrowhead, L 4.3-5.1cm (after ZKKN 1974, Plate 14, 2.3.4.11.13; 140 Fig. 30, 3; Plate 14, 10.12; 140 Fig. 30, 5.4; ZKKN 1961, Plate 6, 5; ZKKN 1974, Plate 14, 7.5.6).

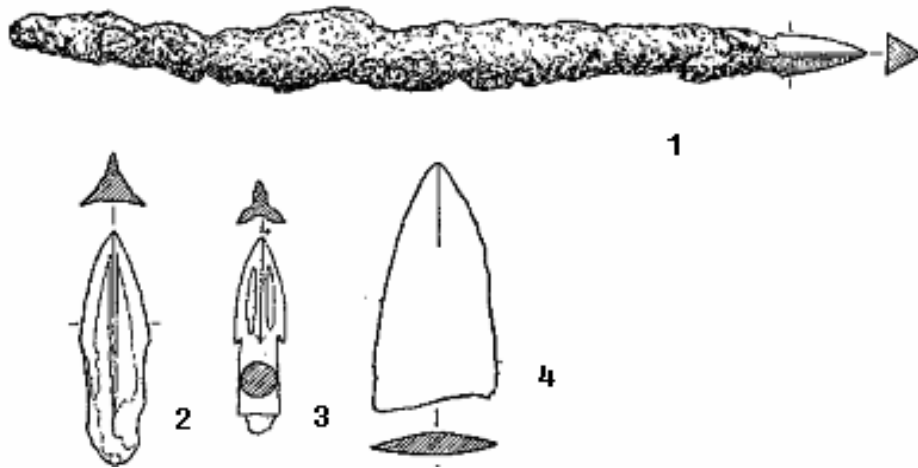


Fig. 074a. Zhizhushan, bronze objects, 1-3 arrowhead, L 18cm.4.5cm.4cm; 4 sword, L 5.1cm (after ZHSKYN 1979, 238 Fig.19, 10.1.2.6).

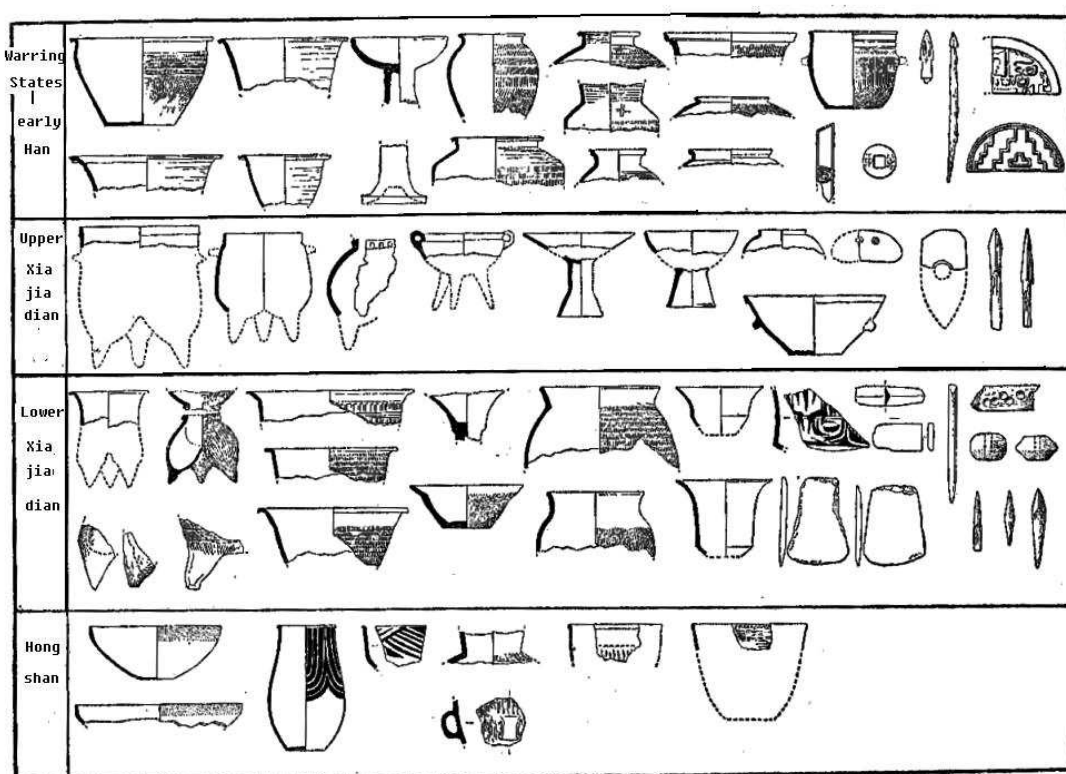


Fig. 074b. Zhizhushan, potteries of the four succeeding layers: Hongshan culture, Lower Xiajiadian culture; Upper Xiajiadian culture; the Warring States-early Han (adapted from ZHSKYN 1979, 240 Fig.20).

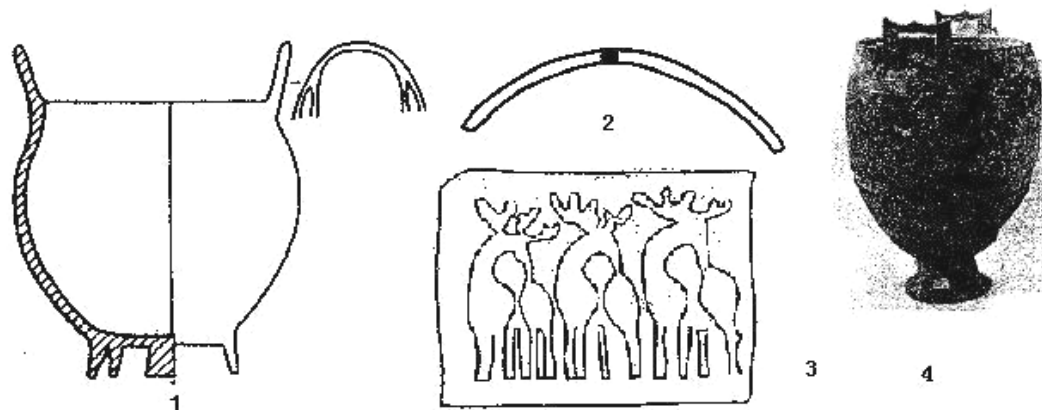


Fig. 075. Metal objects, 1-3 from Susitai; 4 from Dayingzi (1.2.4 bronze; 3 gold), 1 Fu-cooking ware, H 14cm; 3 plaque, L 7.8cm; 4 Fu-cooking ware, H .67cm (after Wang G. 1997, 462 Fig. 2, 1; Fig. 3, 2.1; Wang G. 1994, 133 Fig. 2).

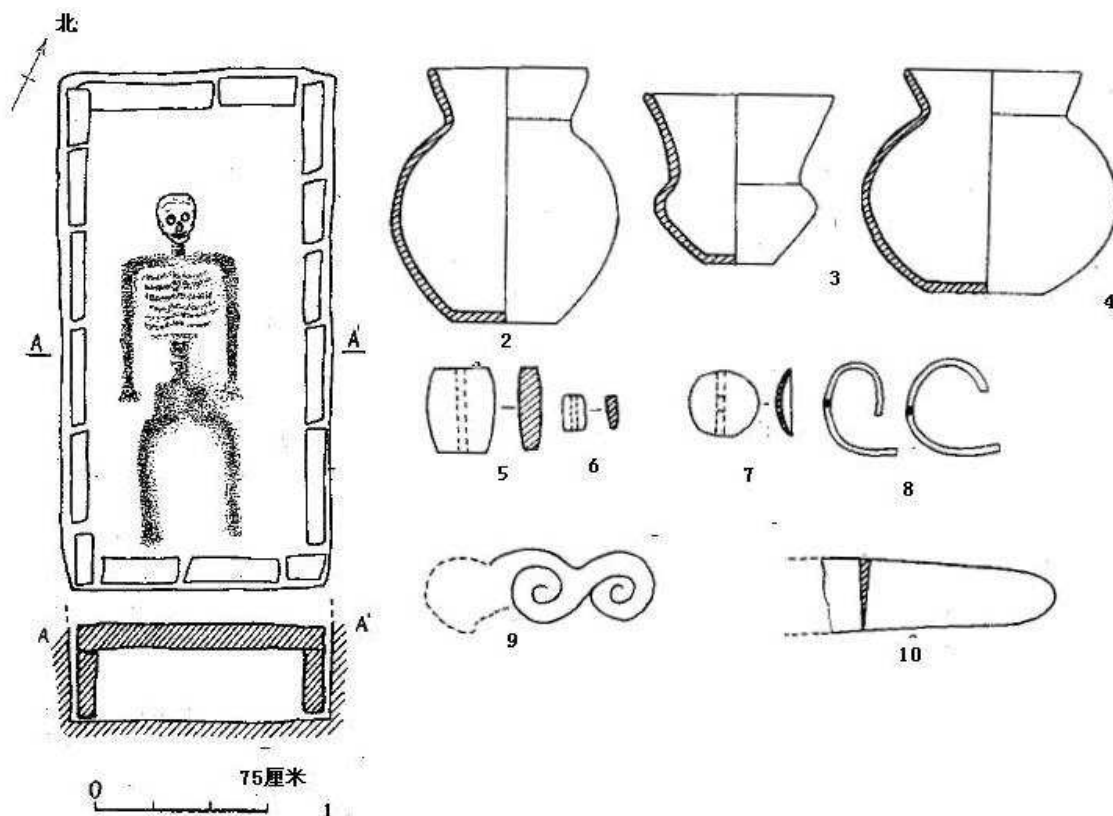


Fig. 076a. Jinggouzi, tomb excavated in 1996, 2-4 pottery; 5.6 turquoise; 7-10 bronze; 1-3 H 17cm.11.4cm.15cm; 5.6 H 1.8cm.0.8cm; 7 dm 1.2cm; 8.9 L 4.8cm.5cm (after Wang G. 1998, 2 Fig. 2; 3 Fig. 3, 1-3; Fig. 4, 1.3.2.4-6).

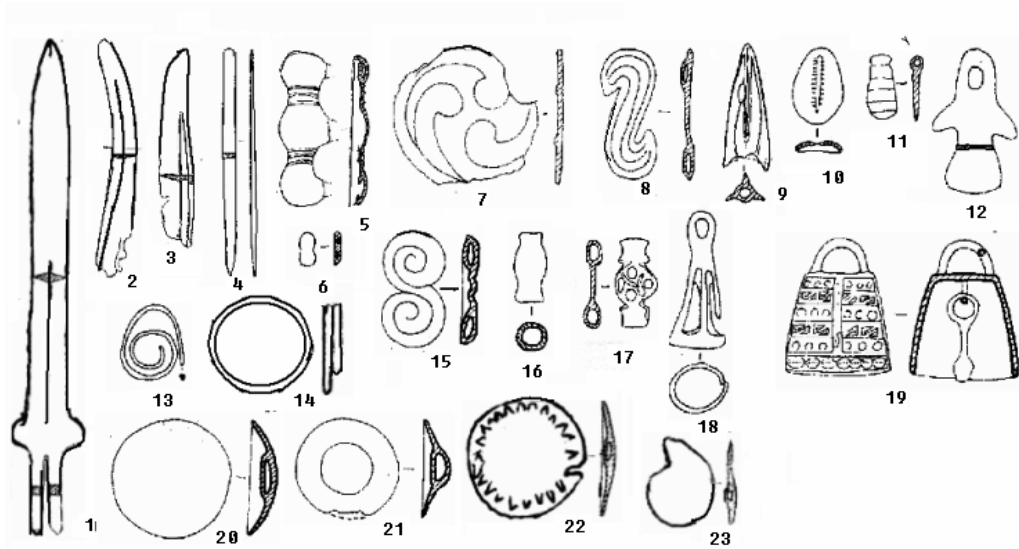


Fig. 076b. Jinggouzi, bronzes objects, 1 sword, L 39.8cm; 2.3 knife, L 13cm.11.7cm; 4 awl, L 12.4cm; 5-6 joined beads, L 4.2cm.0.9cm; 7.8 ornament, L 4cm.3.6cm; 9 arrowhead, L 3.4cm; 10-12 ornament, L 2.1cm.1.7cm.4cm; 13.14 earring, dm 2cm.3.6cm; 15 ornament, L 3.6cm; 16 tube, L 1.9cm; 17 varied bird figure, L 2.5cm; 18.19 bell, L 3.8cm.3.9 cm; 20-24 bulb, dm 3.2cm.2.8cm.4.6cm.3.5cm (after Wang L. X. et al. 2004, 13 Fig. 8, 1; 12 Fig. 7, 2.3.1.4.15.5.6.7.8.9.17.10; 13 Fig. 8, 4; 12 Fig. 7, 11.12.16.18.19.13.14; 13 Fig. 8, 2.3).

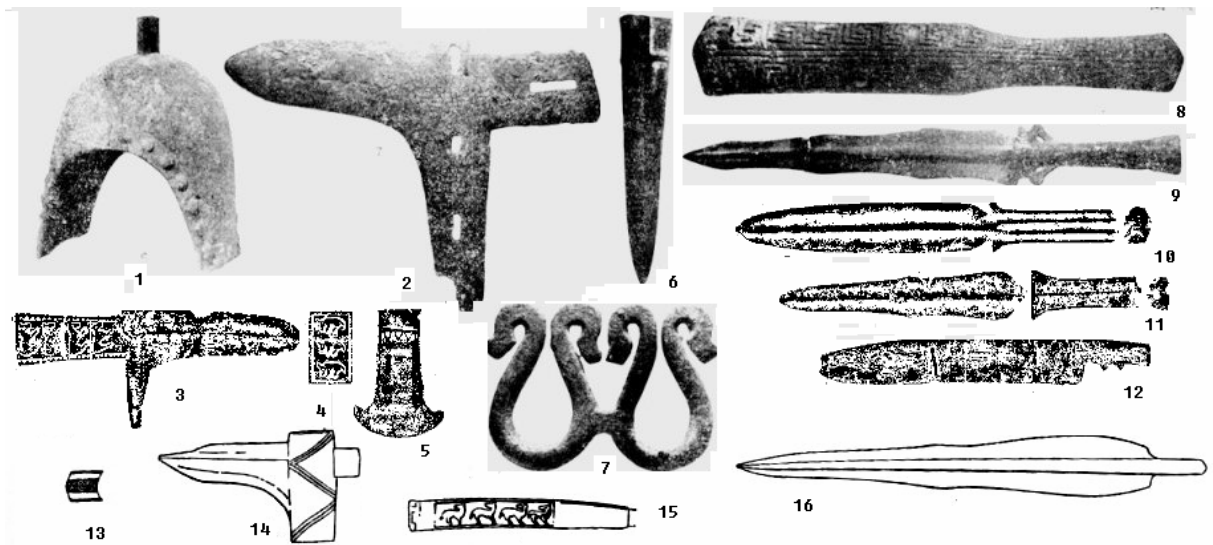


Fig. 077a. Nanshangen, collected bronzes in 1958, 1 helmet, L 24cm; 2.3 dagger, L 17cm.24cm; 4 plaque, L 4.9cm; 5 axe, L 8.5cm; 6 Zun (罇), L 10cm; 8 sheath, L 35.5cm; 9 spear, L 38cm; 10-11 sword, L 27.5cm.26 cm; 12 knife, L 22cm (after Li Y. Y. 1959, Plate 276-277, Fig.1-2, Plate 1, 6.7; 276 Fig. 1; 277 Fig. 2, 3.4; Plate 1, 3.4.1.2; 277 Fig. 2, 5.6.7; ZKKN 1975, 138 Fig. 20, 2.4.3.1).

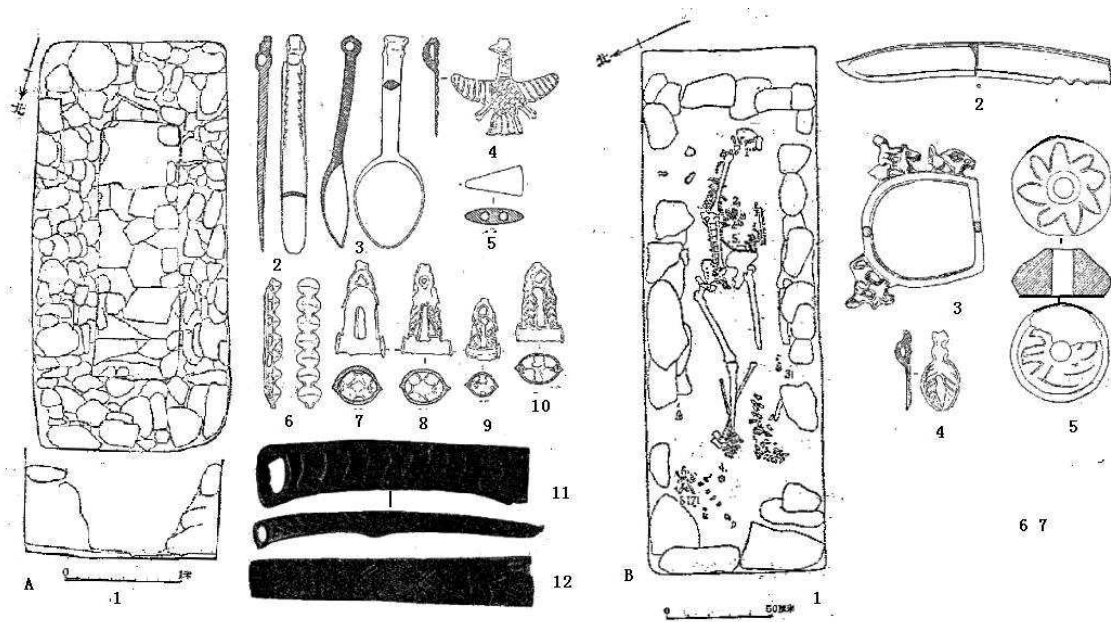


Fig. 077b. Nanshanben, Tomb M3 and M4, A Tomb M4; B Tomb M3 (A, 5 bone; B, 5 pottery whirl; others bronze). A 2.3 spoon, L 9cm.9.8cm; 7-10 bell, L 2.8-4cm; 11 knife, L 25.7cm; 12 tube, L 11.85cm (after ZKKN 1975, 134 Fig. 17; 17 Fig. 19, 1.2.5.8.12.13.14.15.16; Plate 7, 1-3); B 2 knife, L 11.9cm (after ZHYYN 1975, 134 Fig. 16; 137 Fig. 19, 3.4.11.17).

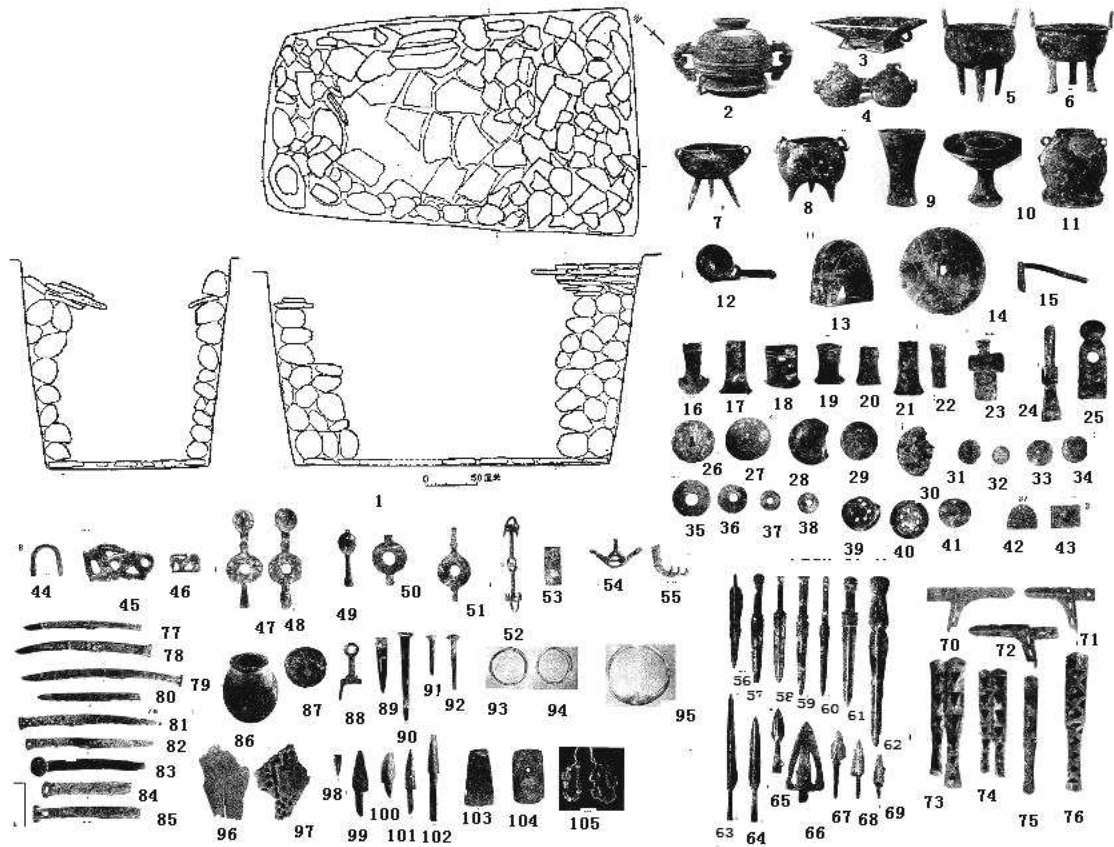


Fig. 077c. Nanshan'gen, Tomb M 101, 2-92 bronzes; 93-95 gold; 96-102 bone; 103-105 stone (after LNZ et al. 1973, 28 Fig. 2; Plate 1-12).

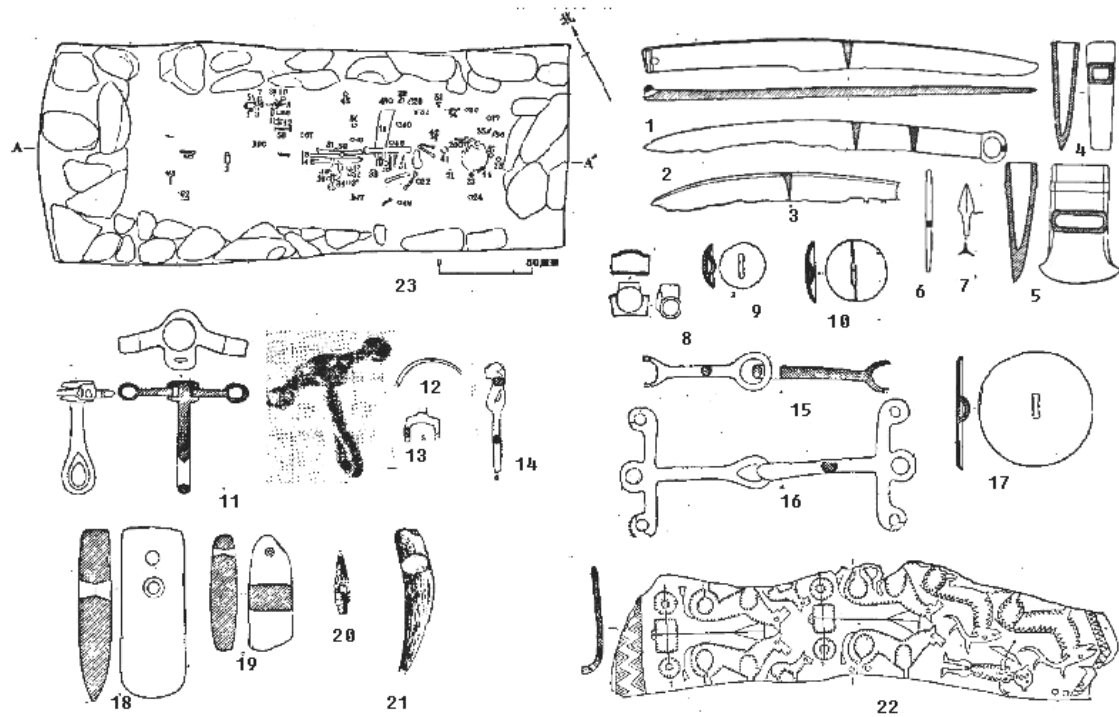
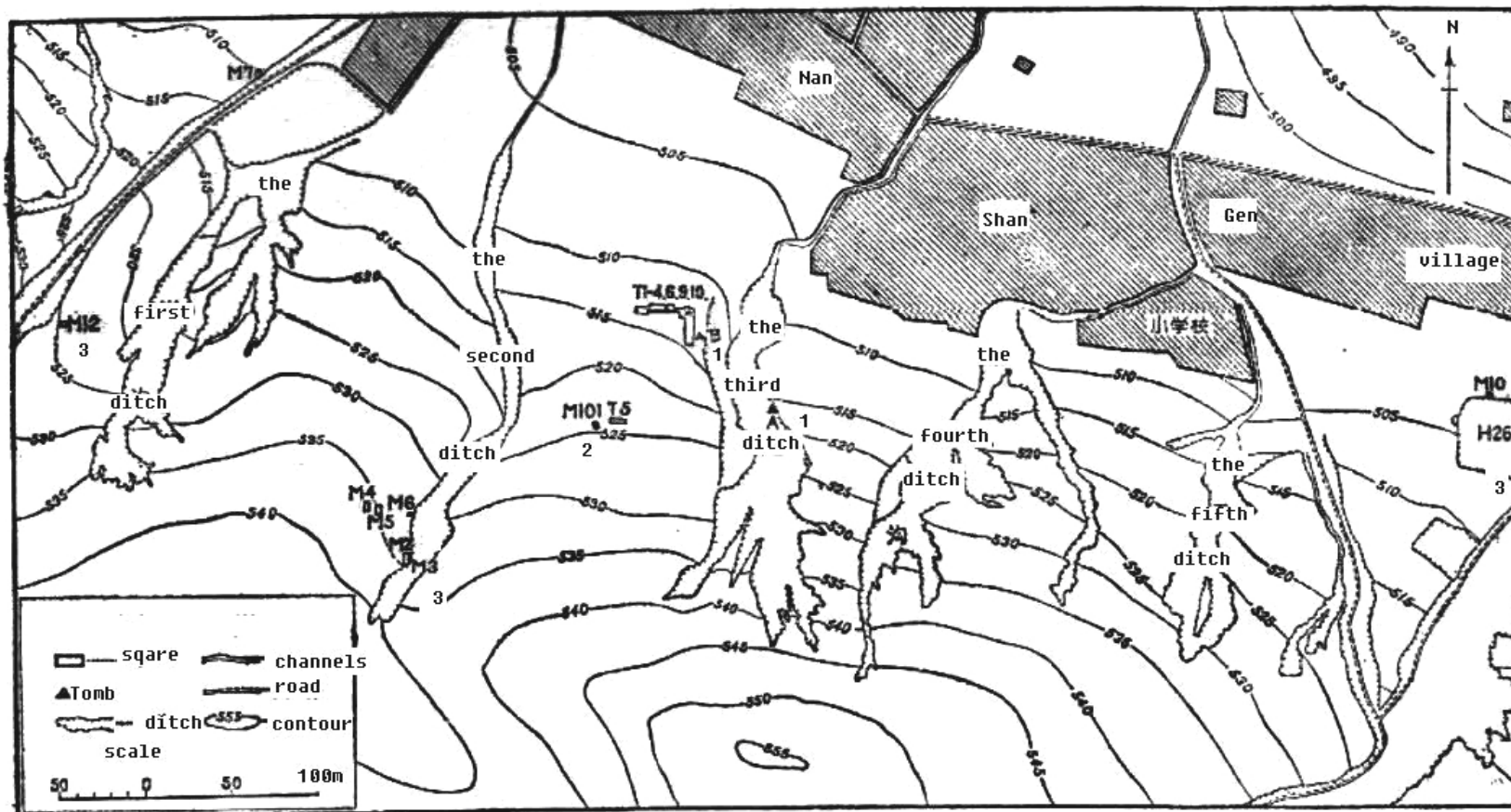
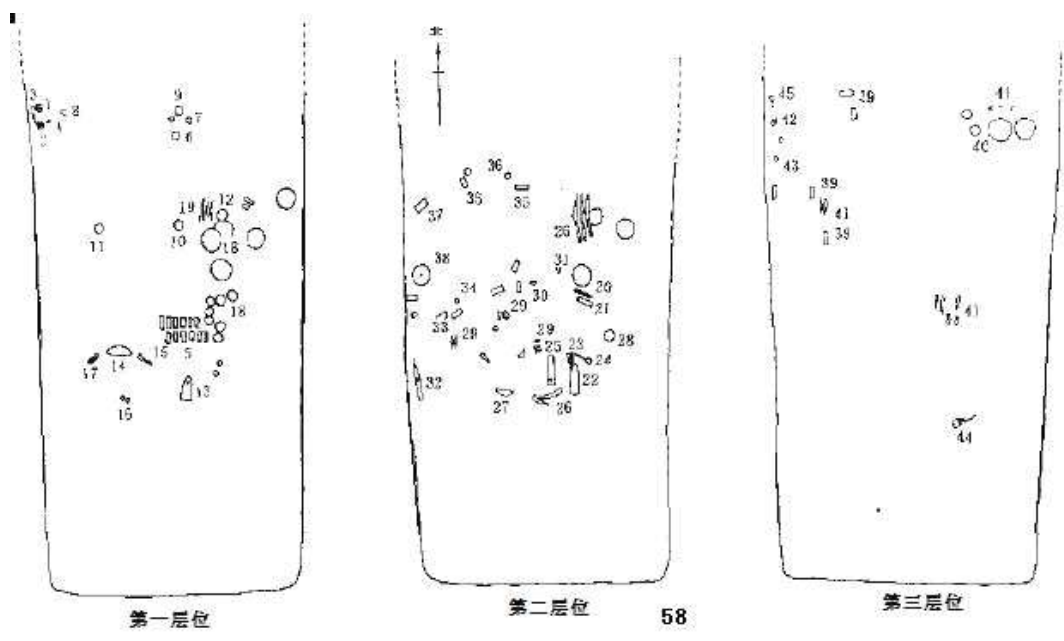


Fig. 077d. Nanshangen, Tomb M102 (1-17 bronze; 18,19 stone; 20-22 bone), 1-3 knife, L 26.2cm.24.2cm.16.2cm; 4 axe, H 7.3cm; 8 adze, L 8cm; 6 awl, L 6.9cm; 7 arrowhead, L 3.5cm; 8 ornament, L 2.5cm; 9-10 bulb, dm: 3.1cm.4cm; 11 horse fitting, L 7.5cm; 12-14 broken object, L 7cm.4cm.7.5cm; 15-16 gag bit, L 16.2cm.19.8cm; 17 mirror, dm 7.8cm; 18 stone axe, L 11.5cm; 19 L 7.7 cm; 21 horn, L 9.4cm; 22 incised bone board, L 34cm (after ZHSKYD 1981, 305 Fig. 2, 1-4.7.5.6; 306 Fig. 4, 1.3.2.4; Fig. 5, 4.5.6; Fig. 4, 5.6.; Fig. 5, 2.1.7.3.8; Fig. 6).



1 excavated in 1958 2 excavated in 1963 3 excavated in 1961

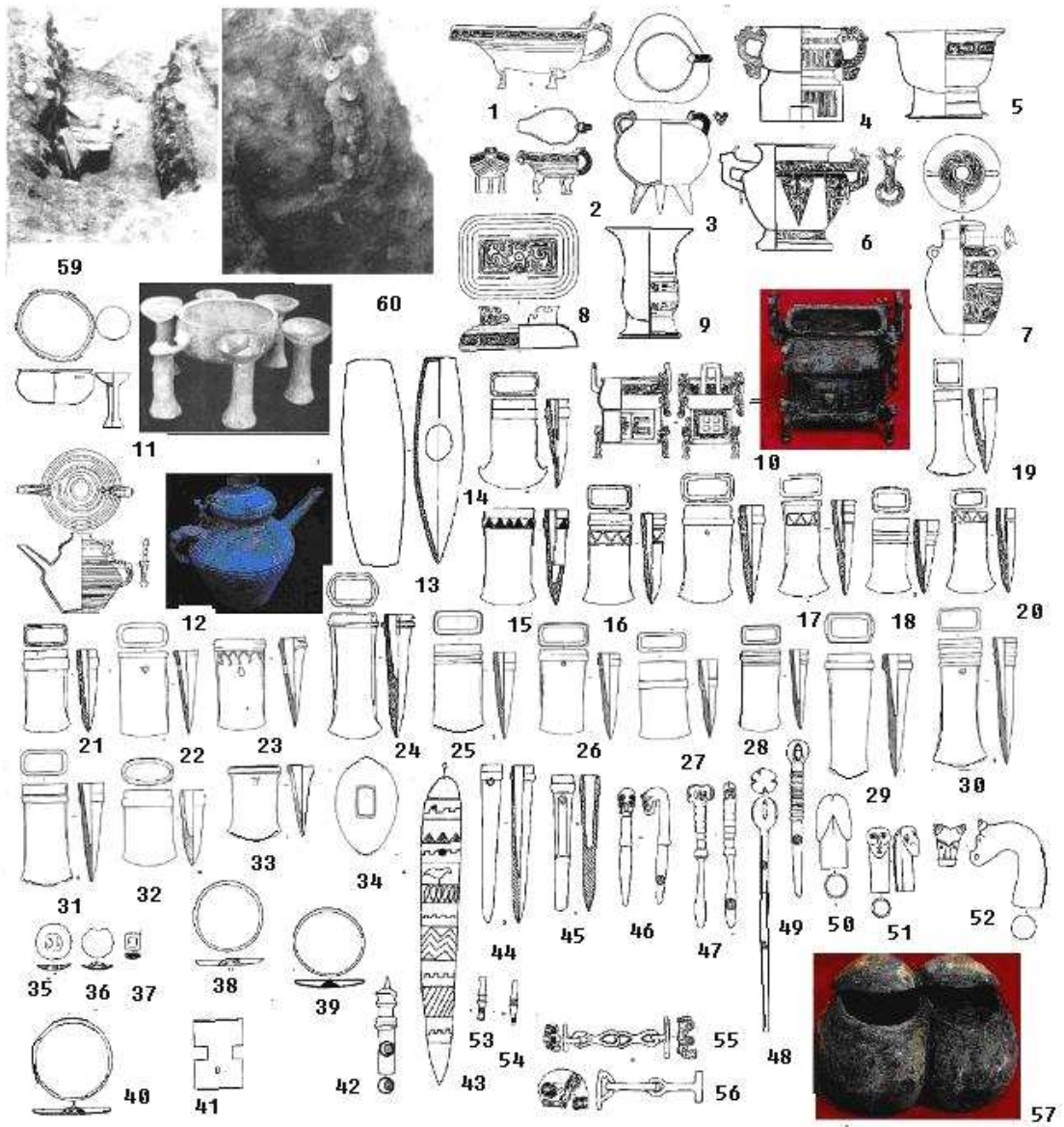
Fig. 077e. Nanshangen, distribution of tombs (adapted from ZKKN 1975, 118 Fig. 2)



第一层位

第二层位 58

第三层位



57

Fig. 078a. Xiaoheishigou, funeral bronze objects, 1-2 Yi (匜), H 19cm.9.3cm; 3 Ding (鼎), H 26cm; 4-5 Gui (簋), H 25.5cm.17cm; 6 Lei (罍), H 28cm; 7 Hu (壺), H 30.6cm; 8 cover, W 16.6cm; 9 Zun (罇), H 23.8cm; 10 Ding, H 12.4cm; 11 six-joined pot, H 15.6cm; 13 He (盃), H 21cm; 13-31 axe, L 7.2-17.8cm; 32-33 adze, L 7.7cm.7.3cm; 34 hammer, L 9.9cm; 35-40 buckle, dm 2.5-10.7cm; 41 H 15.7cm; 42, L 7.9cm; 43.46-49 awl, L 19cm.7.7cm.9.4cm.15.2cm.10.4cm; 44.45 chisel, L 10.4cm.9cm; 50.51 head of pole, H 6cm.5.4cm; 52 animal head, H 8cm; 53.54 nail, L 3.1-3.6cm; 55-56 gag bit, L 9cm.8.8 cm; 57 joint pot, H 15cm (after Xiang/Li 1995, 8 Fig. 6; 7 Fig. 5, 4; 8 Fig. 6, 6.1; 5 Fig. 5, 2; 8 Fig. 6, 2.4; 7 Fig. 5, 3; 8 Fig. 6, 8; 7 Fig. 5, 1; 8 Fig. 6, 7; 12 Fig. 12; 8 Fig. 6, 5; 13 Fig. 14, 1-5; Fig. 15, 1-6; 14 Fig. 16, 1-12; 16 Fig. 19, 6.7.8; 17 Fig. 21, 2; 16 Fig. 19, 12.13; 15 Fig. 17, 1-7; 16 Fig. 19, 1.2.5.3.4.9.11; WW 5, 1995, Cover 3, 2).

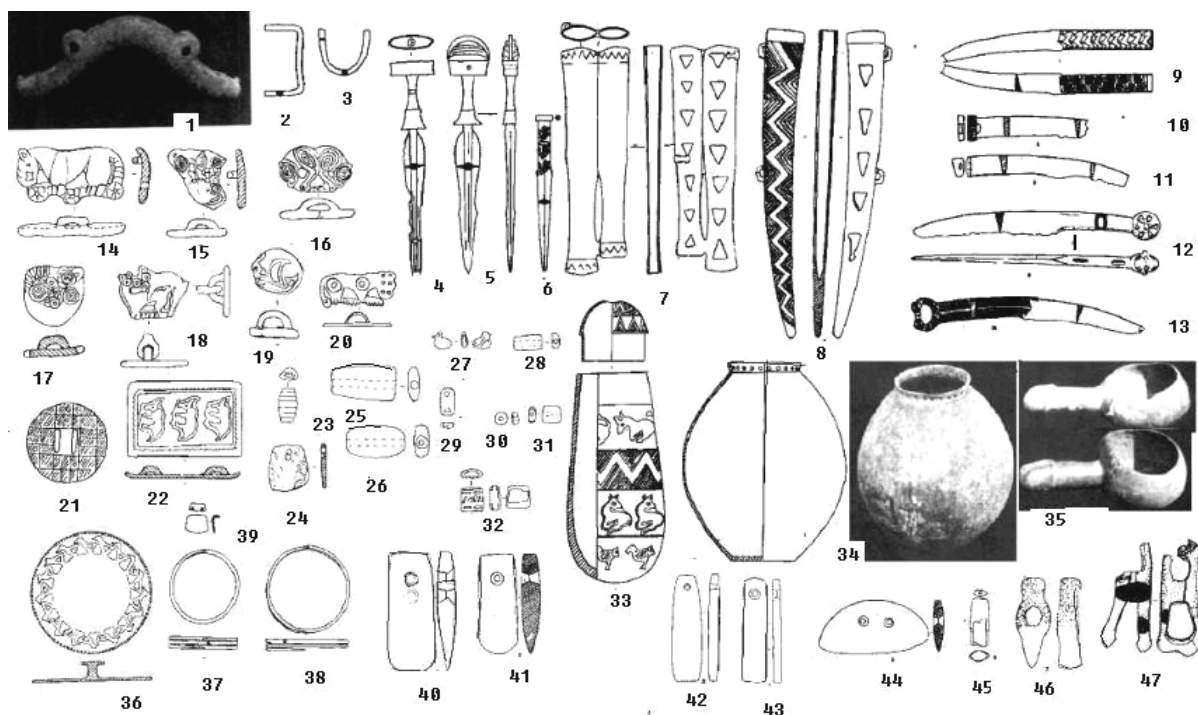


Fig. 078b. Xiaoheishigou, funeral objects (1-35 bronze; 36-39 gold ware; 40-46 stone ware; 47 bone ware), 2-3, L 5.3cm.7.3cm; 4-5 sword, L 41.5cm.36.7cm; 6 dagger, L 13.5cm; 7 double-jointed scabbard, L 39.3cm; 8 scabbard, L 26.5cm; 9-13 knife, L 18cm.10.6cm.14.4cm.21.9cm.20.5cm; 14-22 plaque, L 2-4.7cm; 23-32 small ornament, L 0.7-2.4cm; 33 round based utensil, H 13.6cm; 34 flat-based vase, H 11.3cm; 35 spoon, W 26.5cm; 36 gold plaque, dm 7.1cm; 37-38 gold loop, dm 4.0-4.1cm; 39 gold ornament, L 1.3cm; 40-42.46 stone axe, L 13.6cm. 11.5cm.12.3cm.12cm.10.4cm; 44 knife, W 13cm; 45 millstone, L 5.5cm; 47 bone ware, L 15.8cm (after Xiang /Li 1995, 16 Fig. 20; 17 Fig. 21, 3.5; 17 Fig. 22, 1-6.8.9.7.10; 18 Fig. 23, 1-10.19.12.13.11.17.14.15.16.18; 19 Fig. 1.2; 20 Fig. 26; Fig. 28; 24 Fig. 24, 1-3; 15 Fig. 18, 1-7; 17 Fig. 21, 1).

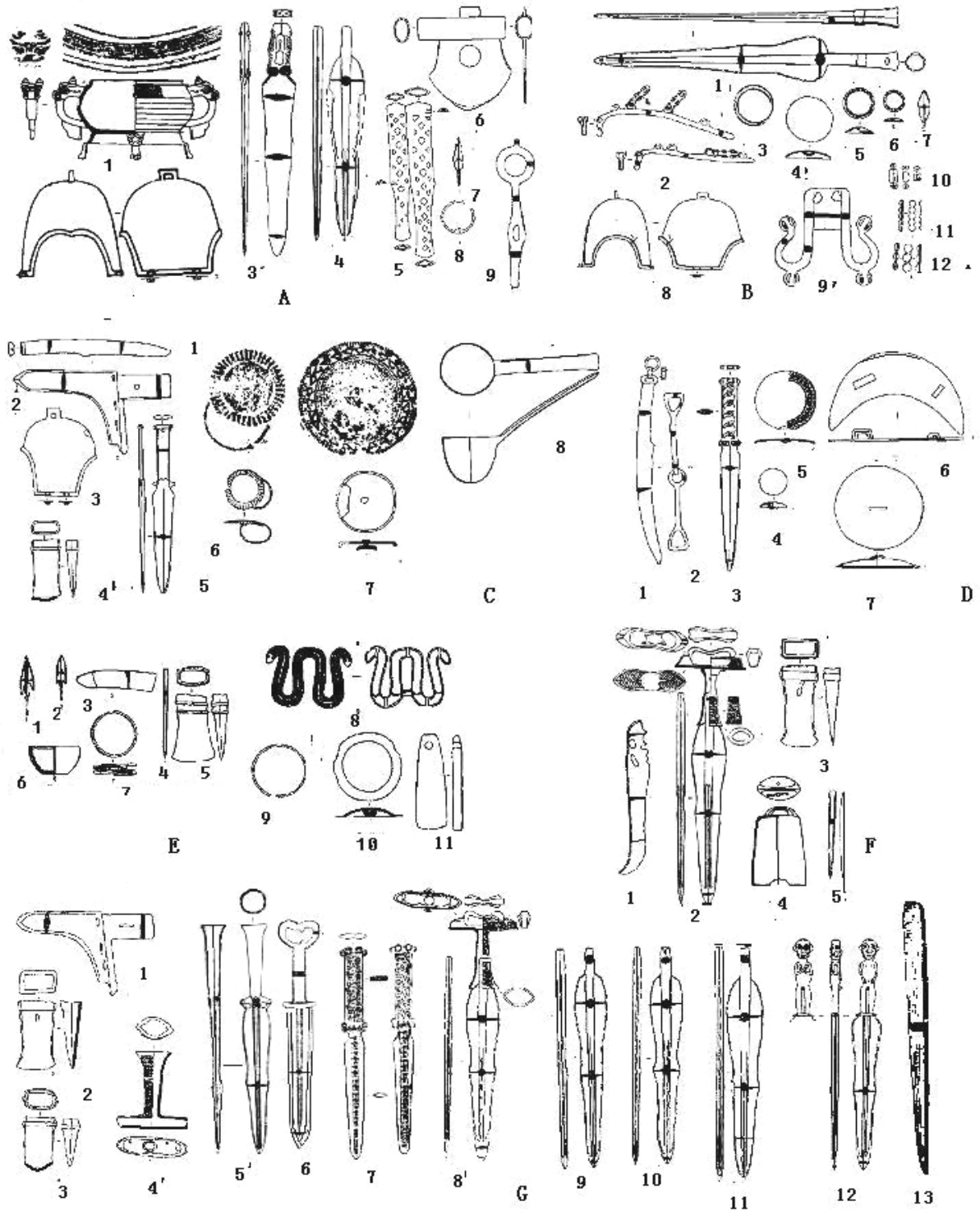


Fig. 079. Metal objects, **A** from Beishanzui, Tomb M7501, 1 Gui, H 16cm; 2 helmet, H 22cm; 3-4 sword, L 31.8cm; 6 Yue, H 13.6cm; 7 arrowhead, L 7.25cm; 8 gold loop, L 20.4cm; 9 L 20.4cm (after Jin F. Y. 1985, 25 Fig. 3, 1.2; Fig. 4, 1.2; 26 Fig. 5, 1-5); **B** from Xiaoheshigou, Tomb M8061, 1 sword, L 41.7cm; 2 L 19cm.16.5cm; 3 gold bracelet; 4-6 bulb, dm 6.3cm.4.2cm.2.9cm; 7 arrowhead, L 4.4cm; 8 helmet, L 21.2cm; 9 L 13.4cm; 10 bone bead, L 0.85-1.95cm; 11.12 buckle, L 4.25cm.3.9cm (after Jin F. Y. 1985, 29 Fig. 11, 1.3.4.6.7.8.2; 28 Fig. 10, 1.2; 29 Fig. 11, 5; 28 Fig. 10, 3.4); **C** from Wafangzhong, Tomb M791; 1 knife, L 20.65cm; 2 dagger, L 21.65cm; 3 helmet, H 24cm; 4 axe, L 7.9cm; 4 sword, L 23.1cm; 6.7 plaque, dm 5.2-5.4cm; 8.4cm; 8 spoon, L 17cm (after Jin F. Y. 1985, 27 Fig. 7,1-5; 28 Fig. 8;

Fig. 9, 1-3); **D** from Tianjuqua, Tomb M7301, 1 knife, L 28.7cm; 2 gag bit, L 21.7cm; 3 sword, L 26.9cm; 4.5 bulb, dm 3.75cm.8.3cm; 6, L 18.5cm; 7 mirror, dm 11.5cm (after Jin F. Y. 1985, 30 Fig. 13, 1.2; Fig. 12, 1.3.2; Fig.13, 3; Fig. 12, 4); **E** from Liangjiayingzi, Tomb M8071, 1.2 arrowhead, L 6.1cm.4.3cm; 3 knife, L 8cm; 4 awl, L 9.3cm; 5 axe, L 7cm; 6 pot; 7 loop, dm 4.7cm; 8 ornament, L 8.8cm; 9 loop, dm 5.7cm; 10 bulb, dm 7cm; 11 stone, L 9.9cm (after Jin F. Y. 1985, 31 Fig. 14, 1-11); **F** from Sunjiagou, Tomb M7371, 1 knife, L 16.1cm; 2 sword, L 35cm; 3 axe, L 8.5cm; 4 bell, L 16.4cm; 5 awl, L 8.8cm (after Jin F. Y. 1985, 35 Fig. 30, 1; 33 Fig. 23; 35 Fig. 30, 5.4.2); **G** collected bronzes, 1 Liujiagou, L 9cm; 2.4.11 Ningcheng, L 9.5cm.9cm.31.4cm; 3 Sujaiwopu, L 6.9cm; 5.7 Xiaoheishigou, L 30.2cm.28.1cm; 6 Laocanggou, L 30.4cm; 8 Wangyingzi, L 34cm; 9 Dianzi, L 30.2cm; 10 Sidaoyingzi, L 29.9cm; 12 Nanshangen, L 31.7cm; 13 Xiaoyushulinzi, L 6.7cm (after Jin F. Y. 1985, 38 Fig. 35, 1-4; 37 Fig. 32, 1-4; 38 Fig. 34; Fig. 33, 1-3; 36 Fig. 31; NMGG 1965a, 621 Fig. 4, 1).

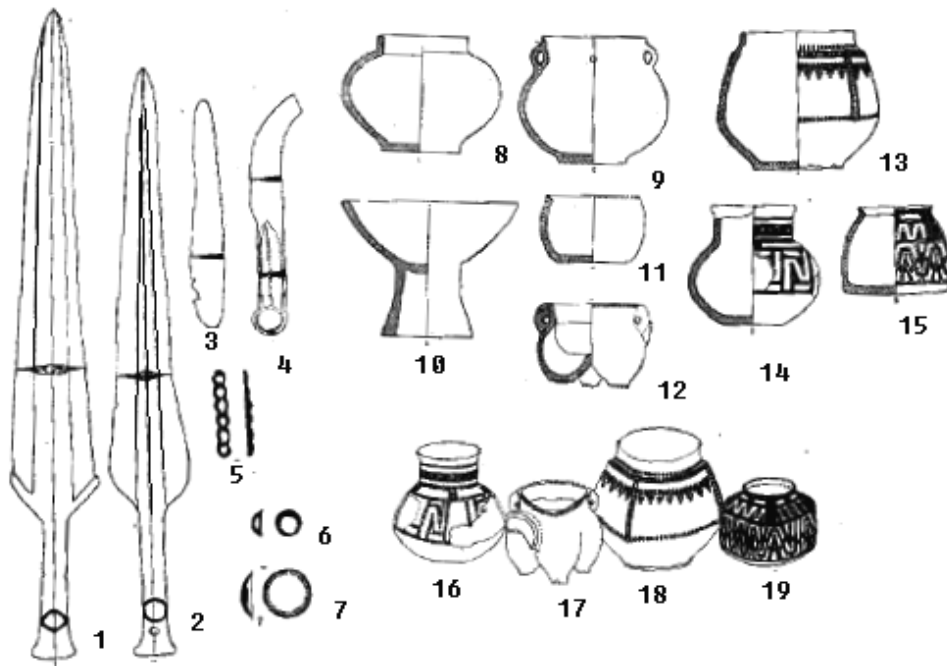


Fig. 080. Dapaozi, funeral objects, 1-7 bronze; 8-19 pottery; 1.2 sword, L 41cm.37cm; 3.4 knife, L 14.5cm.15.5cm; 5 bead, L 5.5-6.7cm; 6.7 bulb, dm 1.2-1.5cm.3.4cm; 8-19 pottery, H 7-17.2cm (after Jia H. E. 1984, 52 Fig. 2, 1-7; Fig. 3, 1-5; Fig. 1-3; Fig. 5, 1-4).

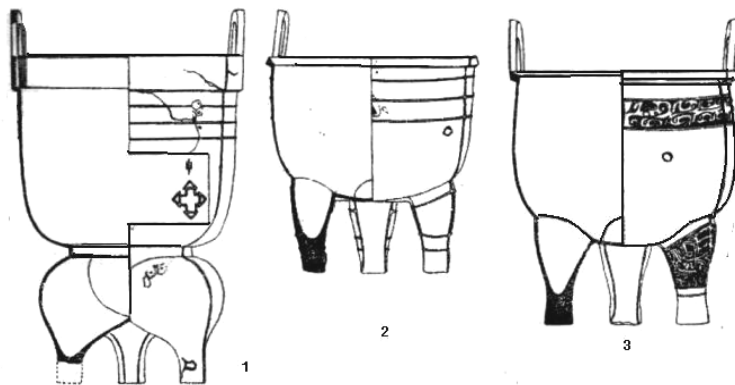


Fig. 081. Toupaizi, bronzes, 1 Yan, H 66cm; 2 Li H 67cm; 3 Li, H 54cm; (after Su H. 1982, 1 Fig1, 1-3).

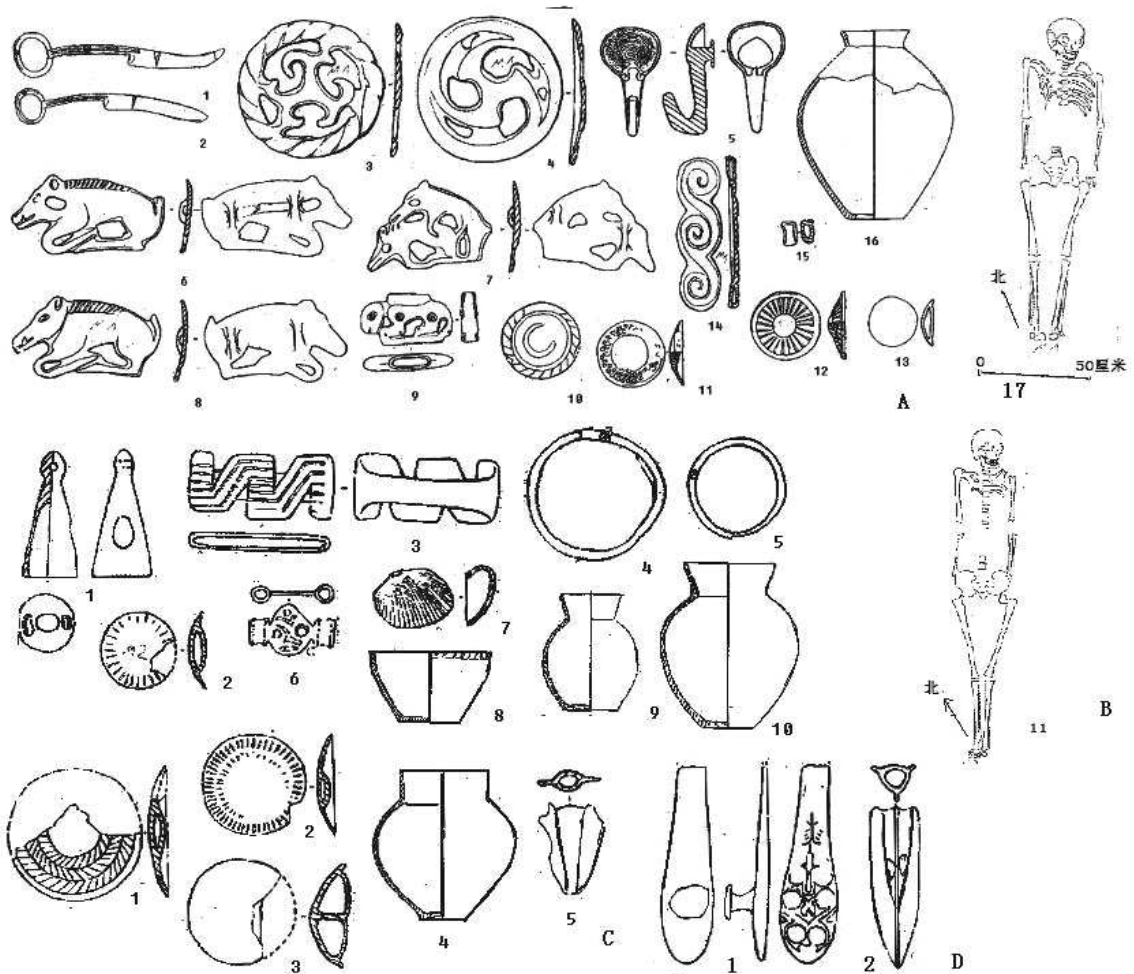


Fig. 082. Tiejiaogou, burials goods, A tomb M1; B tomb M2; C tomb M3; D collected, A: (1-15 bronze; 16 pottery) 1-2 knife, L 19.8cm.17.8cm; 3-4 ring plaque, dm 4.6-4.8cm.4.9cm; 5 belt hook, L 3.8cm; 6-8 animal shaped plaque, L 5.9cm.4.8cm.6cm; 9 bird shaped ornament, L 3.1 cm; 10-13 bulb, dm 3.4cm.2.9cm.3cm.2.1 cm; 14 ornament, L 5.1cm; 15 bead, L 1cm; 16 pottery, L 30cm (after Shao G. T. 1992, 86 Fig. 6, 1.2; 88 Fig. 8, 1.3.2; 87 Fig. 7, 2.1.3.4; 89 Fig. 9, 3.7.6.8; 88 Fig. 8, 8; 87 Fig. 7, 5; 85 Fig. 4, right); B: 1 bell, H 3cm; 2 bulb, dm 2.3cm; 3 belt ornament, L 3.3cm; 4-5 earring, dm 3.2cm.2.3cm; 6 bird figure, L 2.4cm; 7 mussel; 8-10 pottery, H 7.8cm.13cm.58cm (after Shao G. T. 1992, 88 Fig. 8, 7; 89 Fig. 9, 2; 88 Fig. 8, 6.4.5; 90 Fig. 10, 6; 86 Fig. 5, 3.5.4; 85 Fig. 4, left); C: 1-3 bulb, dm 4.6cm.3.1cm.3.3 cm; 4 pot, H 25cm; 5 arrowhead, L 2.2cm (after Shao G. T. 1992, 89 Fig. 9, 5.2.4; 86 Fig. 5, 1; 90 Fig. 10, 7); D: 1 belt hook, L 4.7cm; 2 arrowhead, ca. 3.8cm (after Shao G. T. 1992, 90 Fig. 10, 8.9).

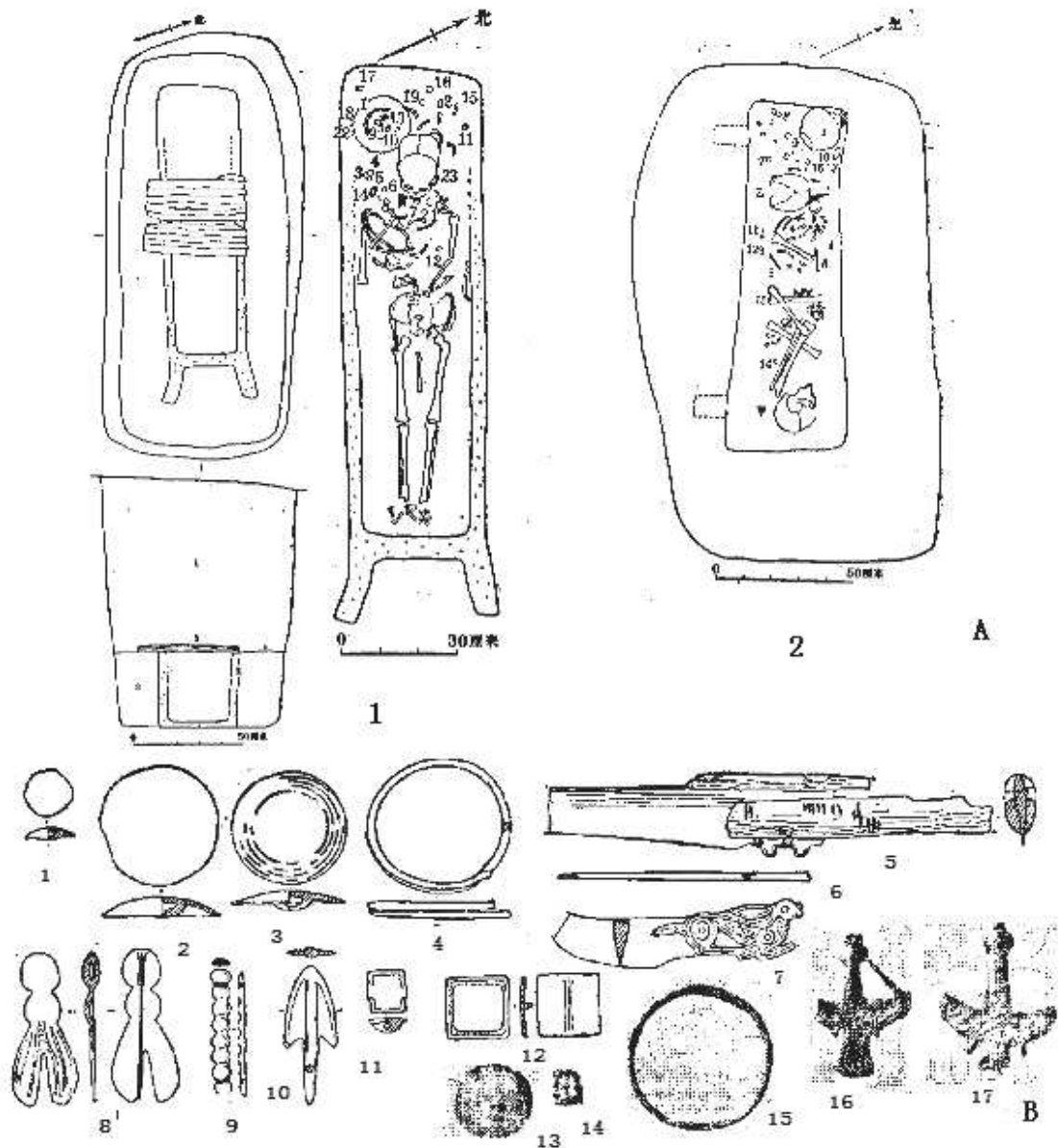


Fig. 083a. Zhoujiadi, funeral objects, A: 1, Tomb M43; 2 Tomb M16 (after ZHSKYN 1984, 419 Fig.5; Fig. 6); B: funeral bronzes, 1-3.13 bulb, dm 1.5-3.7cm; 4 earring, dm 4.2cm; 6 awl, L 7.7cm; 7 knife, L 7.65cm; 8.9 beads, L 4.7cm.4cm; 10 arrowhead, L 4.2cm; 11.12 plaque, L 1.3cm.2cm; 14 ornament, L 1.45cm; 15 earring, dm 5.3cm (after ZHSKYN 1984, 421 Fig. 9, 3.5.7.12.17.16.9.13.15.4.8.422 Fig. 10 7.15.12.1.2).

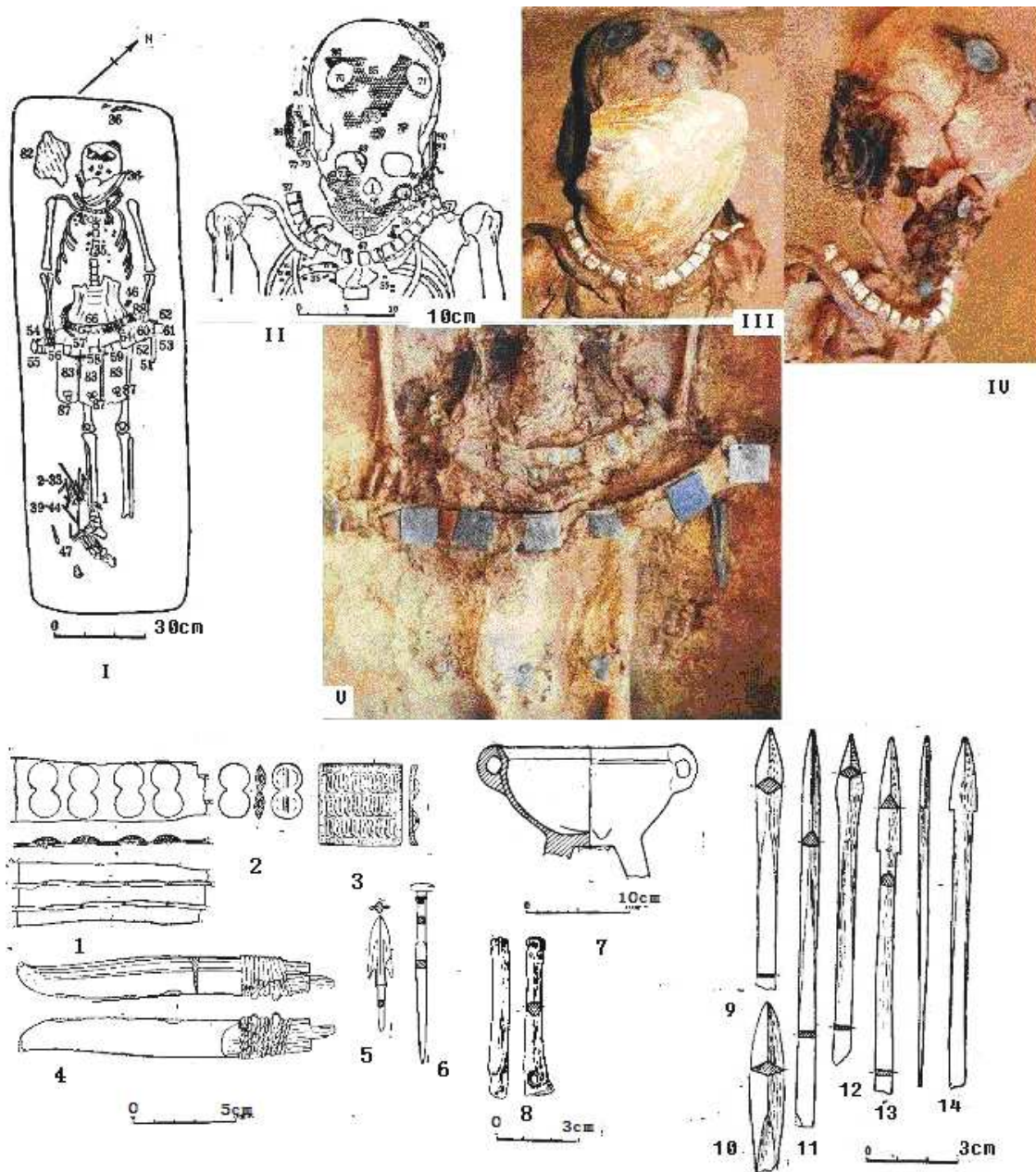


Fig. 083b. Zhoujiadi, funeral objects of Tomb M45 (1-V Plan after ZHSKYN 1984, 418 Fig. 2; Fig. 3; Plate 5, 2.1; Plate 6), 1-6 bronze; 7 pottery; 8-20 bone (after ZHSKYN 1984, 421 Fig. 9, 1.2.10.11.14.18; 420 Fig. 7, 3; 423 Fig. 12, 2; Fig. 11, 1-6).

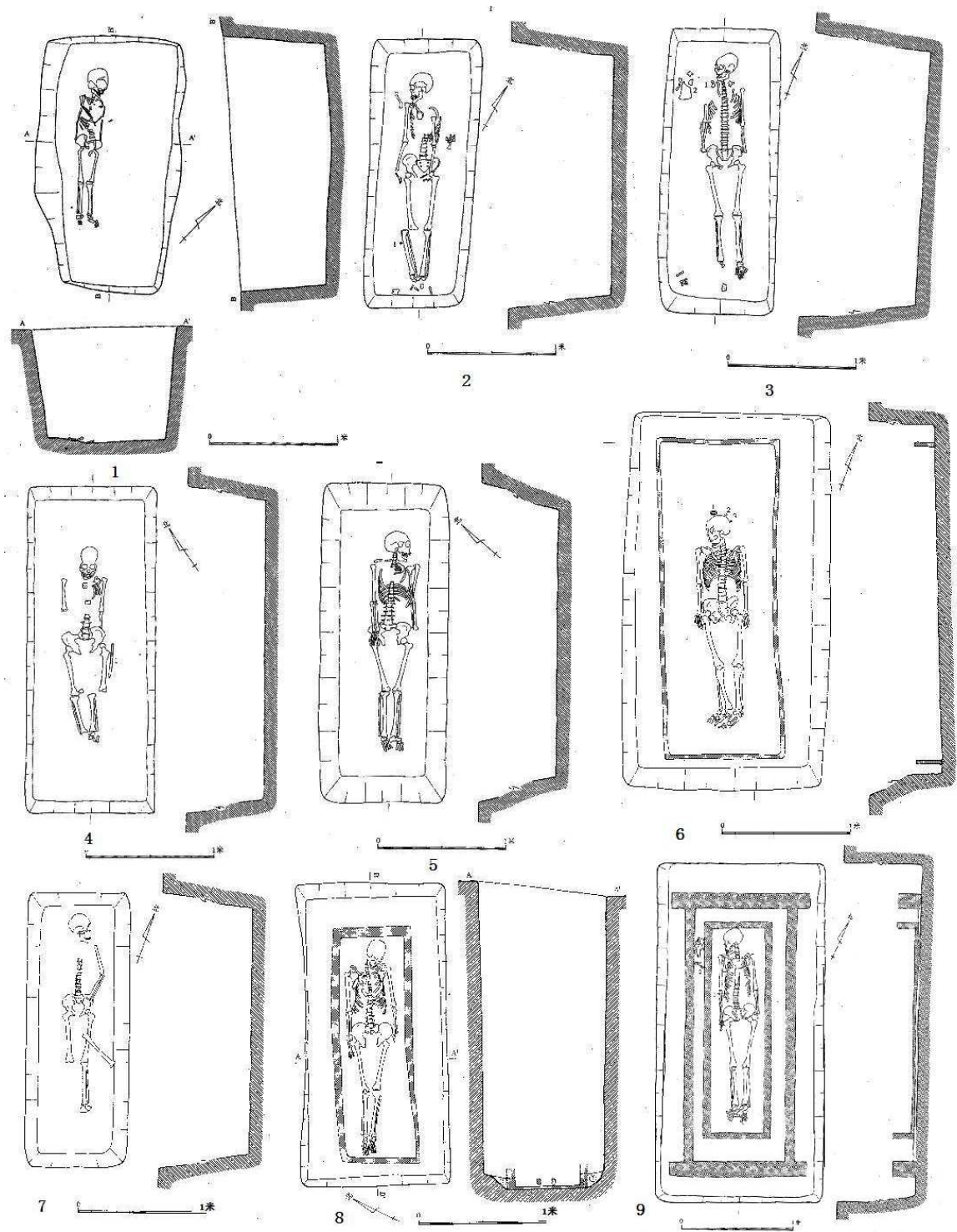


Fig. 084a. Yinniugou, tombs: 1 97YM1; 2 97YM2; 3 97YM3; 4 97YM6; 5 97YM5; 6 97YM4; 7 97YM7; 8 97YM8; 9 97YM9 (after NMGY et al. 2001, 286 Fig. 4; 287 Fig. 5; 288 Fig. 6; 291 Fig. 9; 290 Fig. 8; 289 Fig. 7; 292 Fig. 10; 293 Fig. 11; 295 Fig. 13).

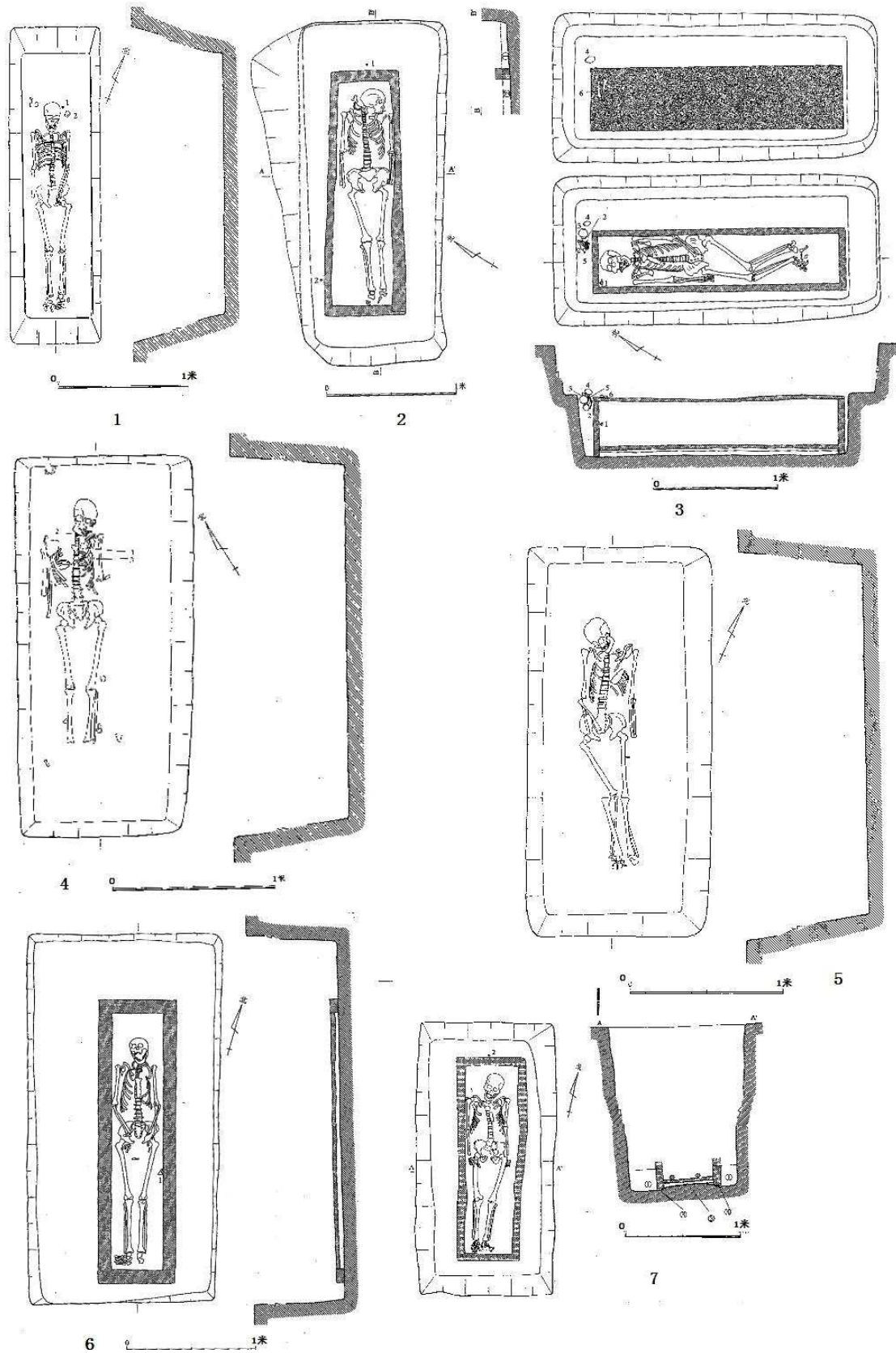


Fig. 084b. Yinniugou, tombs: 1 97YM10; 2 97YM11; 3 97YM12; 4 97YM13; 5 97YM14; 6 97YM16; 7 97YM17 (after NMGY et al. 2001, 296 Fig. 14; 298 Fig.15; 299 Fig.17; 300 Fig. 18; 301 Fig. 19; 304 Fig. 21; 305 Fig. 22).

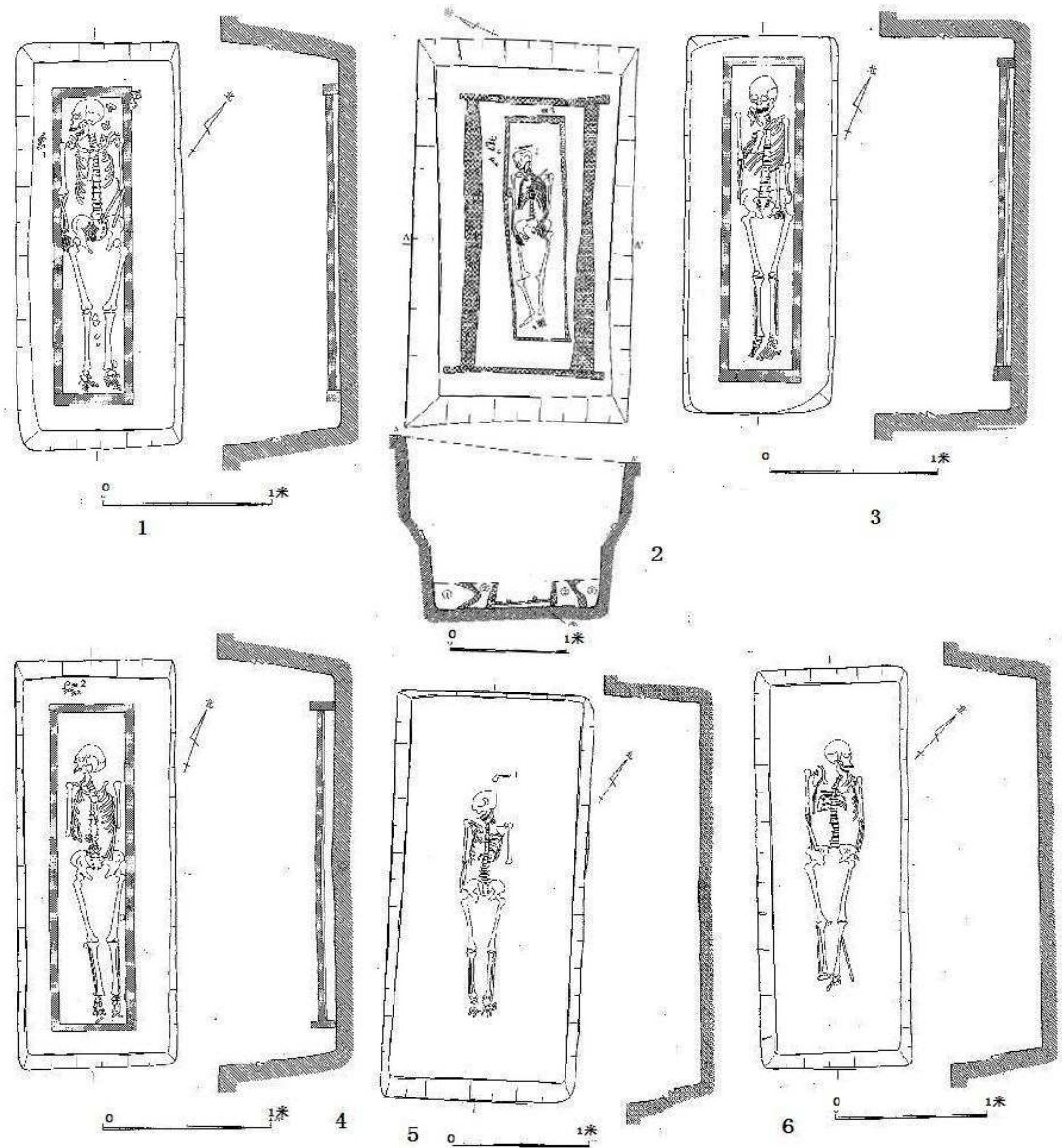


Fig. 084c. Yinniugou, tombs: 1 97Y18; 2 97Y19; 3 97YM20; 4 97YM21; 5 97YM 22; 6 97YM 23 (after NMGY et al. 2001, 306 Fig.23; 307 Fig. 24; 308 Fig. 26; 309 Fig. 27; 310 Fig. 28; 311 Fig. 29).

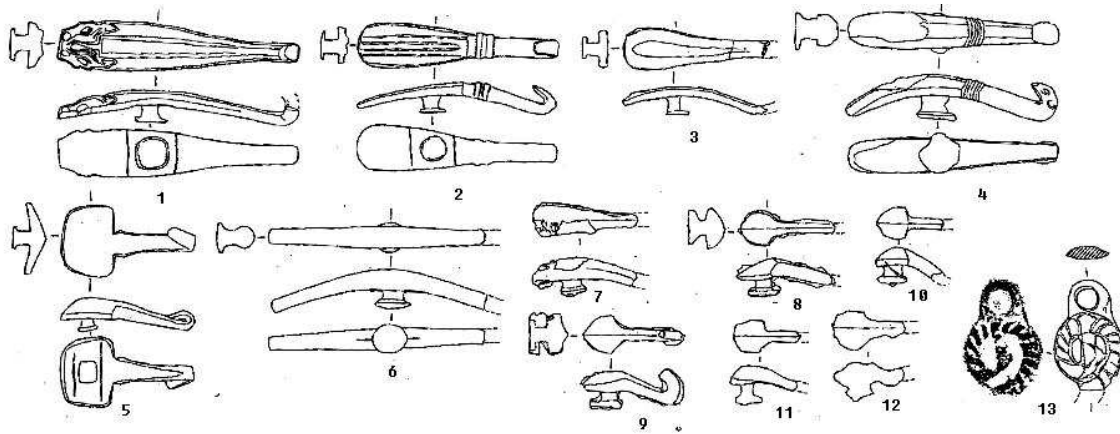


Fig. 084d. Yinniugou, funeral objects (1-6.13 bronze; 7-12 iron), 1-12 belt hook, L 12cm.9.9cm.7.3cm.10.5cm.6.7cm.10.7cm.5.2cm.5.2cm.4.7cm.3.3cm.3.3cm.3.7cm; 13 ornament, L 2.5cm (after NMGG et al. 2001, 313 Fig. 30, 1-12; 315 Fig. 32).

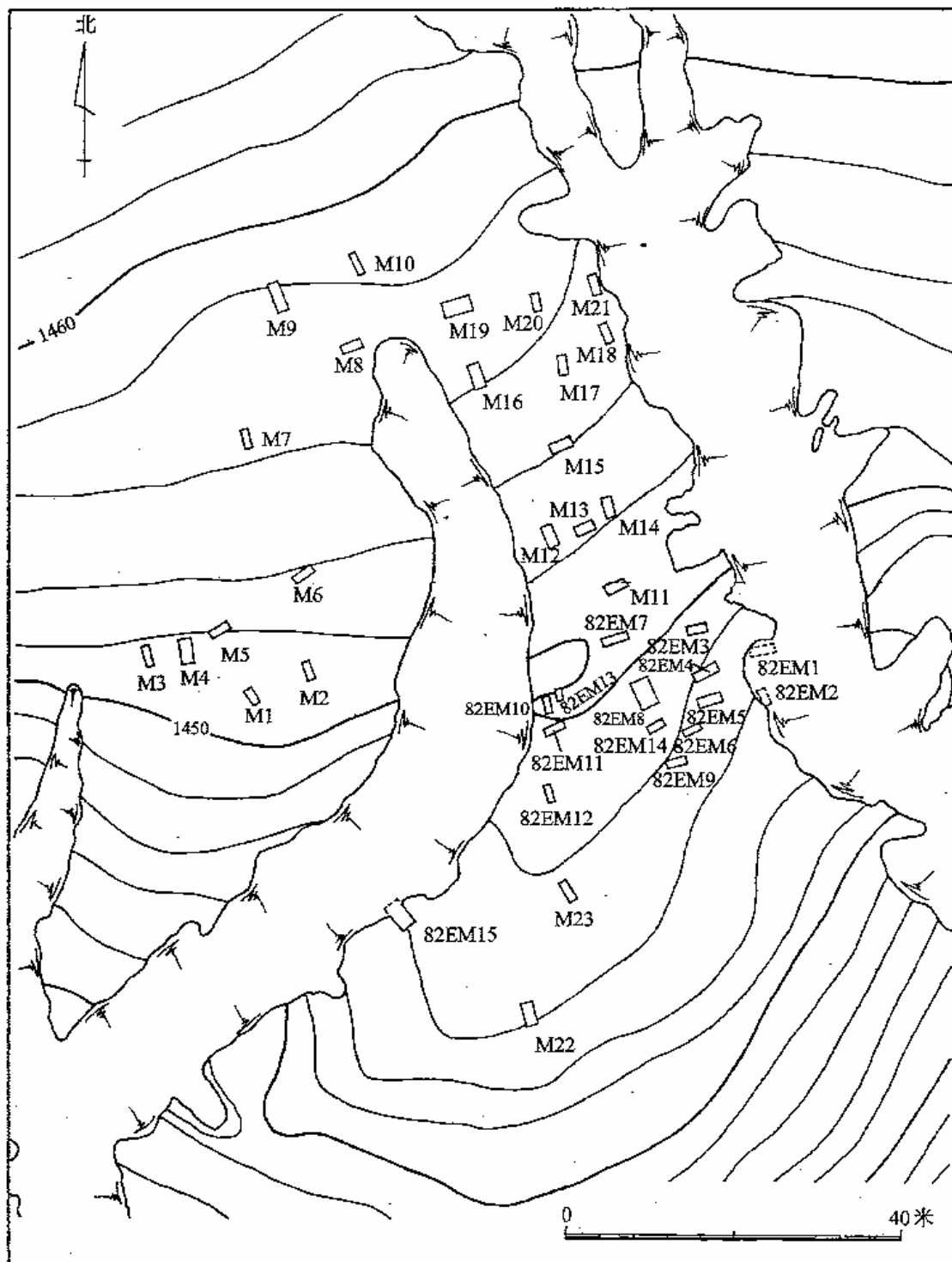


Fig. 084e. Yinniugou, distribution of tombs (82E: the first excavation; others were excavated in 1997 (after NMGY et al. 2001, 284 Fig. 3).

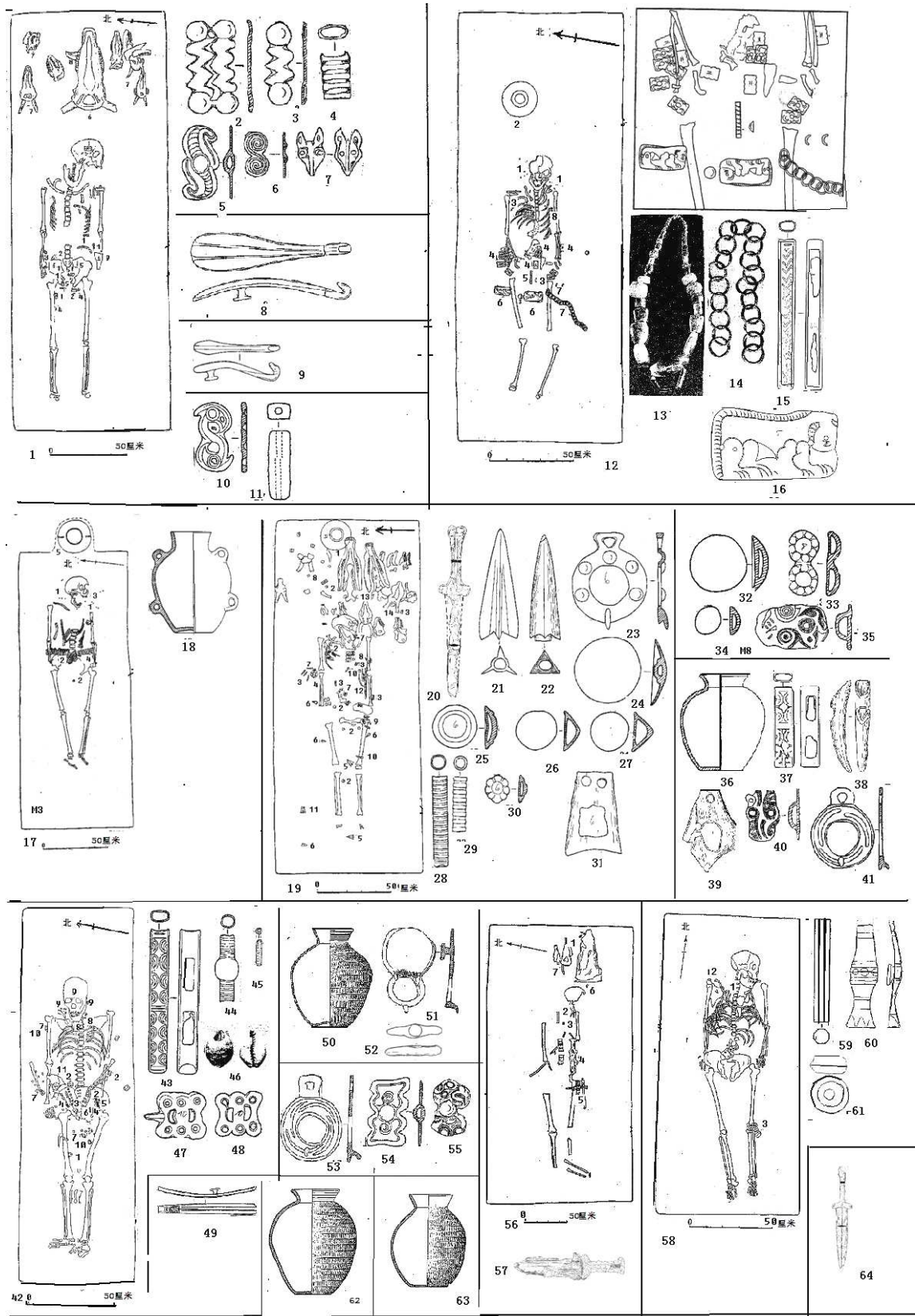


Fig. 085a. Maoqinggou, tombs and funeral goods, 1-7 Tomb M2; 8 Tomb M1; 9 Tomb M4; 10.11 Tomb M7; 12-16 Tomb M5; 17.18 Tomb M3; 19-31 Tomb M6; 32-35 Tomb M8; 36-41 Tomb M9; 42-48 Tomb M18; 49 Tomb M20; 50-52 Tomb M11; 53-55 Tomb M12; 56.57 Tomb M18; 58-61 Tomb M21; 62 Tomb M2; 63 Tomb M30; 64 Tomb M29-2.3 beads, L 4.3cm.4.1cm; 4 tube, L 2.4cm; 5.6 plaque, L 3.8cm.2.4cm; 7 animal shaped ornament, L

2.4cm; 8.9 belt hook, L 11.2cm.6cm; 10 plaque, L 3.3cm; 11 bead, dm 0.3cm; 15 tube, L 8.9cm; 16 plaque, L 10.7cm; 18 pottery, H 30.8cm; 20 iron sword L 29.5cm; 21.22 bronze arrowhead, L 5.4cm.5.4cm; belt buckle, L 6.6cm; 24-27 buckle, dm 1.4-3.9cm; 28.29 tube, L5.1cm.4.1cm; 30 bone buckle, L 5cm; 32.33.34 buckle, dm 2.4cm.1.4cm.1.1cm; 35 plaque, L 3.2cm; 36 pottery, H 20.8cm; 37 tube, L 6.9cm; 38.39 bone ware, L 8.4.7.4cm; 41 buckle, L 5.2cm; 43.44 tube, L 8.9cm.3.3cm; 45 bead, dm 0.3cm; 47.48 plaque, L 3.1cm.2.3cm; 49 belt hook, L 14.5cm; 50 pot, H 28.8cm; 51 belt buckle, L 6.4cm; 52 crane hack, L 2.7cm; 53 belt buckle, L 6.5cm; 54 plaque, L 3.6-5.4cm; 55 bird shaped plaque, L 3.5cm; 57 iron sword, L 29.8cm; 59 stone ware, L 5.6cm; 60 belt hook, L 6.8cm; 61 pottery spindle, dm 3.8cm; 62.63 pot, H 27.4cm.24cm; 64 iron sword, L 28.2cm (after NMGG 1986, 241 Fig. 11; 277 Fig. 43, 1.2; 285 Fig. 47, 6; 272 Fig. 40, 3; 277 Fig. 43, 5.4; 245 Fig. 15; Plate 2; Plate 77, 1; 284 Fig. 46, 7; 281 Fig. 45, 1); 243 Fig. 13, left; 255 Fig. 28, 2; 239 Fig. 8; 260 Fig. 31, 1; 263 Fig. 34, 1.4; 266 Fig. 36, 6; 278 Fig. 44, 10.4.7.9; 284 Fig. 46, 1.3.278 Fig. 44, 2; 286 Fig. 48, 3; 278 Fig. 44, 6.1.5; 275 Fig. 42, 8; 256 Fig. 29, 3; 284 Fig. 46, 6; 286 Fig. 48, 1.2; 275 Fig. 42, 7; 266 Fig. 36, 6; 236 Fig. 7, left; 284 Fig. 46, 8.4.264 Fig. 35, 2; 277 Fig. 43, 6.7; 270 Fig. 38, 4; 255 Fig. 28, 6l 266 Fig. 36, 8; 285 Fig. 47, 5; 266 Fig. 36, 5; 272 Fig. 40,7; 275 Fig. 42, 4; 250 Fig. 23; 261 Fig. 32, 2; 251 Fig. 26; 286 Fig. 48, 5; 270 Fig. 38, 1; 286 Fig. 48, 4; 255 Fig. 28, 4.5; 261 Fig. 32, 1).

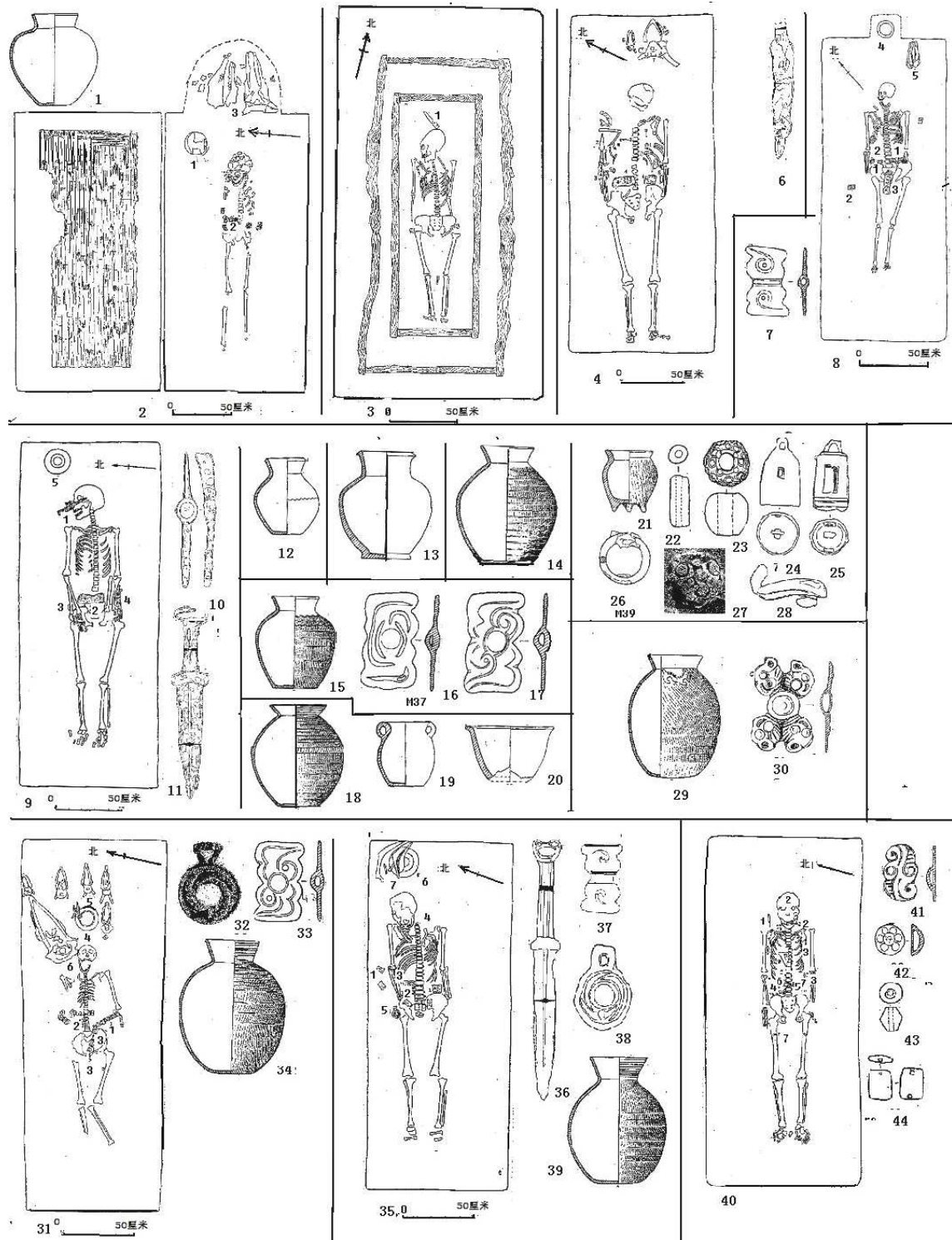


Fig. 085b. Maoqinggou, tombs and funeral goods, 1-2 Tomb M23; 3 Tomb M25; 4-6 Tomb M27; 7-8 Tomb M31; 9-11 Tomb M38; 12 Tomb M33; 13 Tomb M35; 14 Tomb M41; 15-17 Tomb M37; 18-20 Tomb M42; 21-28 Tomb M39; 29.30 Tomb M44; 31-34 Tomb M43; 35-39 Tomb M43; 40-44 Tomb M45-1 pot, H 18.4cm; 6 iron knife, L 18.4cm; 7 plaque, L 4.6cm; 10 iron crane hack, L 19.6cm; 11 iron sword, L 28cm; 12-15.18-20 pot, H 15.2cm.22cm.26.4cm.20.8cm.22.5cm.12.8cm; 16.17 plaque, L 3.6-5.4cm; 21 pot-Li, H 12.8cm; 22.23 bead, dm 1cm.2.3cm; 24.25 bell, H 3.7cm.3.9cm; 26 loop, dm 2.4cm; 29 pot, H 28cm; 30 plaque, L 4.7cm; 32 buckle, dm 5.2-6.5cm; 33 plaque, 3.6-5.4cm; 34 pot, H 30cm 36 sword, L 27.8cm; 37 plaque, L 4.6-5.3cm; 38 buckle, L 6.3cm; 39 pot, H 28cm; 41 bronze

plaque, L 2.9cm; 42 buckle, dm 1.6cm; 43.44 bead, dm 1.2cm.1.4cm (after NMGG 1986, 256 Fig.29, 4; 234 Fig. 5; 235 Fig. 6; 246 Fig. 17; 262, Fig. 33, 4; 273 Fig.41, 6; 233 Fig. 3; 246 Fig. 16; 262 Fig. 33, 5; 261 Fig.32, 3; 256 Fig. 29, 2.9; 255 Fig. 28, 1.5; 272 Fig. 40, 12; 273 Fig. 41, 2; 254 Fig. 27, 8; 256 Fig. 29, 6.10.11; 264 Fig. 35, 6.9; 285 Fig. 47, 2.3; 270 Fig. 39, 2; plate 113, 9; 270 Fig. 38, 2; 254 Fig. 27, 6; 275 Fig. 42, 5; 244 Fig. 14 left; plate 57, 6; 272 Fig. 40, 6; 254 Fig. 27, 5; 247 Fig. 19; 258 Fig. 30, 6; 273 Fig. 41, 4; 266 Fig. 36, 3; 254 Fig. 27, 2; 242 Fig. 12; 275 Fig. 42, 6; 278 Fig. 44, 3; 264 Fig. 35, 7.4).

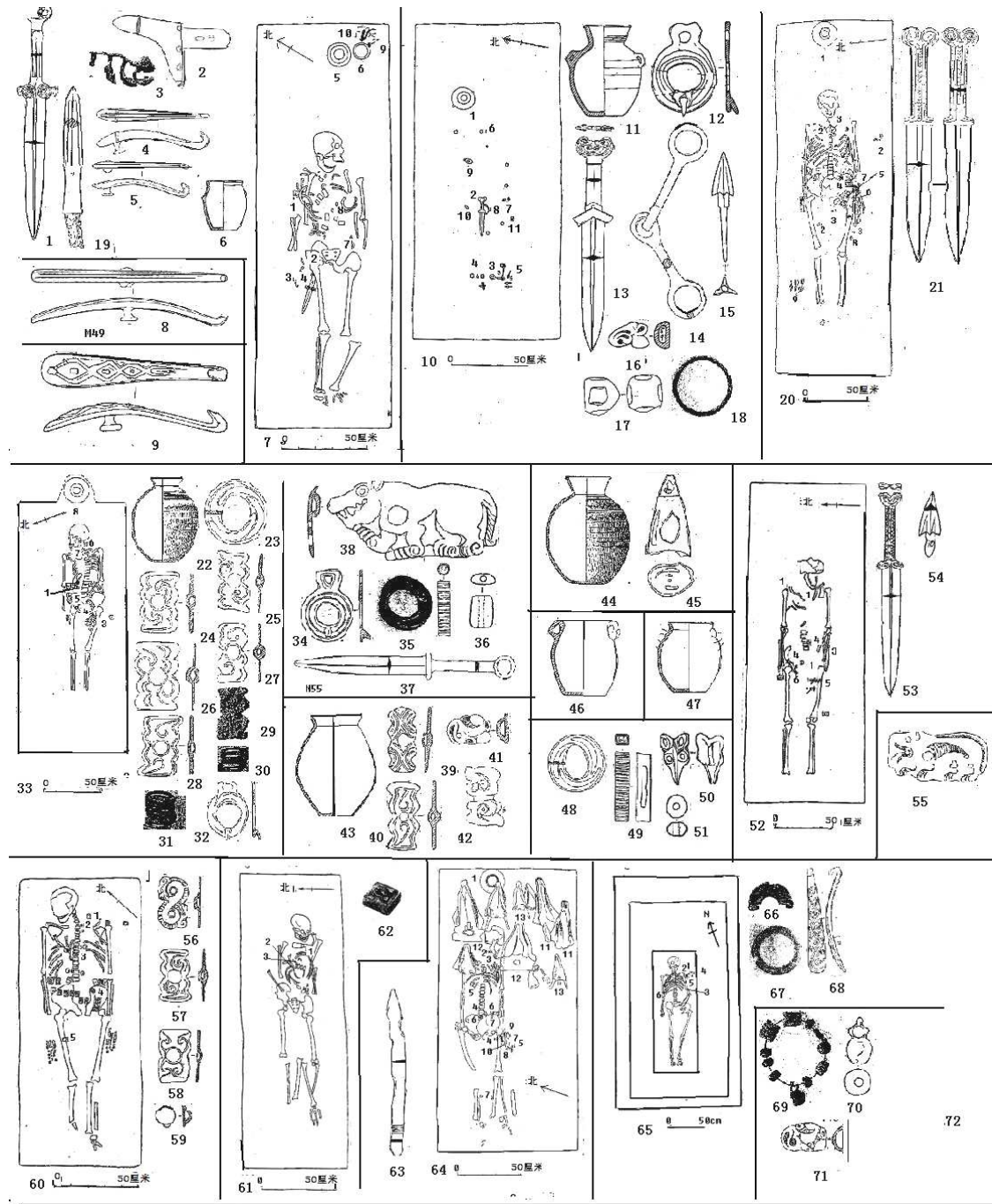


Fig. 085c. Maoqinggou, tombs and funeral goods, 1-7.19 Tomb M58; 8 Tomb M49; 9 Tomb M53; 10-18 Tomb M59; 20.21 Tomb M60; 22-32 Tomb M63; 34-38 Tomb M55; 39-43 Tomb M61; 44.45 Tomb M62; 46 Tomb M64; 47 Tomb M77; 48-51 Tomb M66; 52-54 Tomb M70;

55 Tomb M74; 56-60 Tomb M71; 61.62 Tomb M67; 63.64 Tomb M75; 65-68 Tomb M81; 69-71 Tomb M65 —1.13 sword, L30cm.27.3cm; 2 dagger, L 20.5cm; 4.5 hook, L 10.7cm. 9.4cm; 6.11 pot, H 12.4cm.20cm; 8.9.14.2cm.13.4cm; 12 buckle, L 5.5cm; 14 gag bit, L 20cm;15 arrowhead, L 4.8cm;18 loop, dm 6.5cm; 21.37 sword, L 26.6cm.25.2cm; 22.44 pot, H 29cm.25.6cm; 23 loop, dm 4.5cm; 24-29.39-41 plaque, L 3.3-5.4cm; 35 plaque, L 10.3cm; 44.46.47 pot, H 27cm.17.6cm.14.2cm; 45 bell, L 4.6cm; 55 plaque, L 11cm; 56-58 plaque, L3.6-5.4cm; 59 buckle, dm 1.1cm; 53 sword, L 27.8cm; 54 arrowhead, L 3.3cm; 63 bronze spear, L 18.7cm; 67 bone bracelet, dm 4cm; 68 belt hook, L 13.4cm (after NMGG 1986, 258 Fig. 30, 4; 262 Fig. 33, 1; plate 113, 6; 269 Fig. 37, 1.2; 256 Fig. 29, 5; 238 Fig. 9; 270 Fig. 38, 3; 269 Fig. 37, 4; 249 Fig. 21; 254 Fig.27, 3; 266 Fig. 36, 1; 258 Fig. 30. 1; 287 Fig. 49, 2; 263 Fig. 34, 3; 275 Fig. 42, 1; 287 Fig. 49, 1; plate 77, 4; 262 Fig. 33, 2; 248 Fig. 20; 260 Fig. 31, 2; 254 Fig. 27, 9; 270 Fig. 39, 3; 273 Fig. 41, 1.; 272 Fig. 40, 11. 273 Fig. 41, 3; 272 Fig. 40, 10.13; plate 80, 13; plate 51, 2 right, left; 266 Fig. 36, 2; 250 Fig. 24; 28266 Fig. 36, 5; plate 77, 3; 284 Fig. 46, 2; 264 Fig. 35, 3; 260 Fig. 31,3; 281 Fig. 45, 3; 272 Fig. 40, 8.9; 275 Fig. 42, 2; 273 Fig. 41, 5; 256 Fig. 29,1; 254 Fig. 27, 1; 285 Fig. 47, 1; 256 Fig. 29, 7.8; 270 Fig. 39, 1; 284 Fig., 46, 5; 277 Fig. 43, 3; 264 Fig. 35, 5; 247 Fig. 18; 258 Fig. 30. 2; 263 Fig. 34, 2; 281 Fig. 45, 2; 272 Fig. 40, 1.5.4; 278 Fig. 44, 8; 249 Fig. 22; 251 Fig. 25; plate 113, 7; 262 Fig. 33, 2; 240 Fig. 10; 233 Fig. 4; plate 77, 2.7; 268 Fig. 37, 6; plate 52, 1; 285 Fig. 47, 4; 275 Fig. 42, 3).

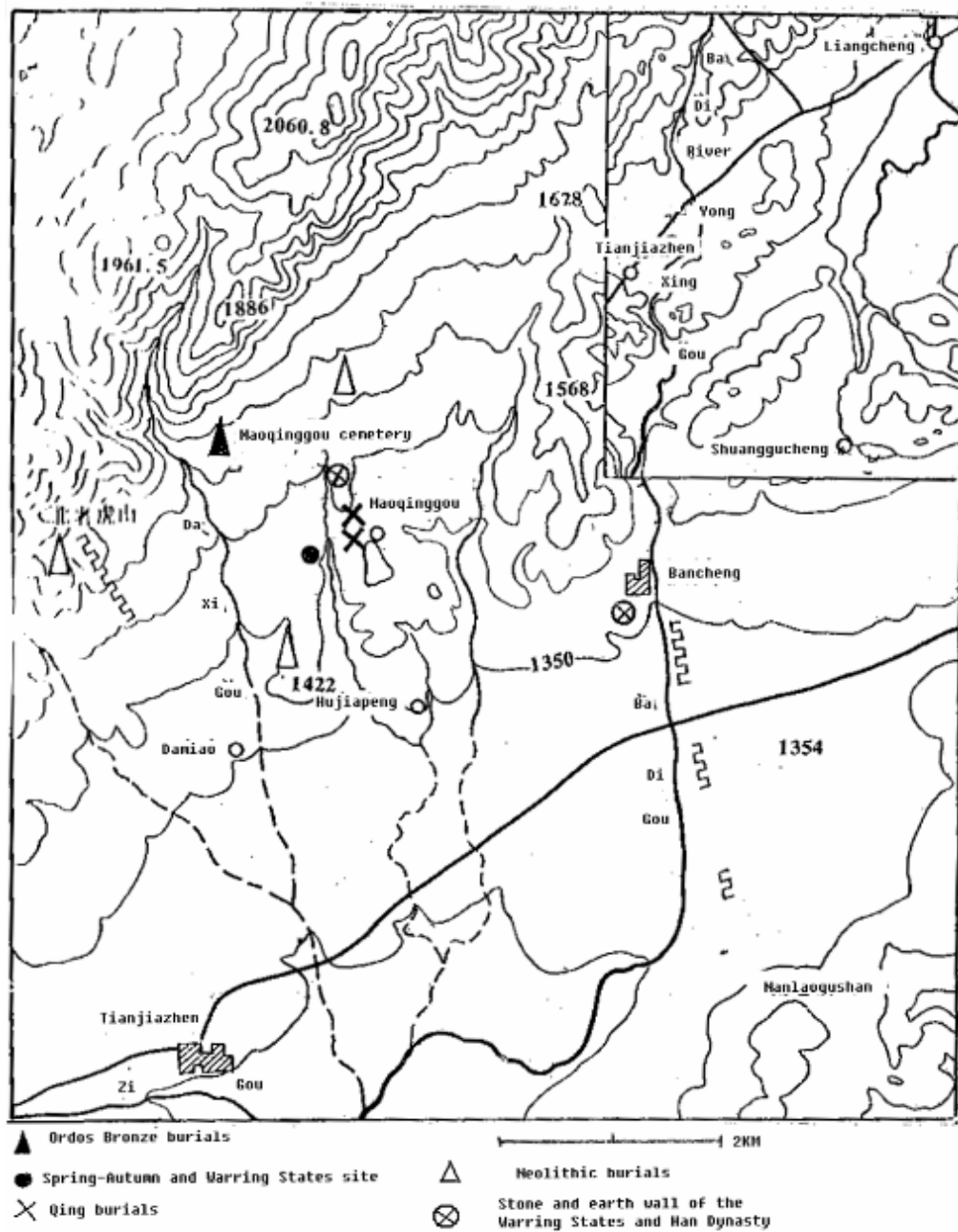


Fig. 085d. Maoqinggou, plan of cultural remains (adapted from NMGG 1986, 229 Fig. 1).

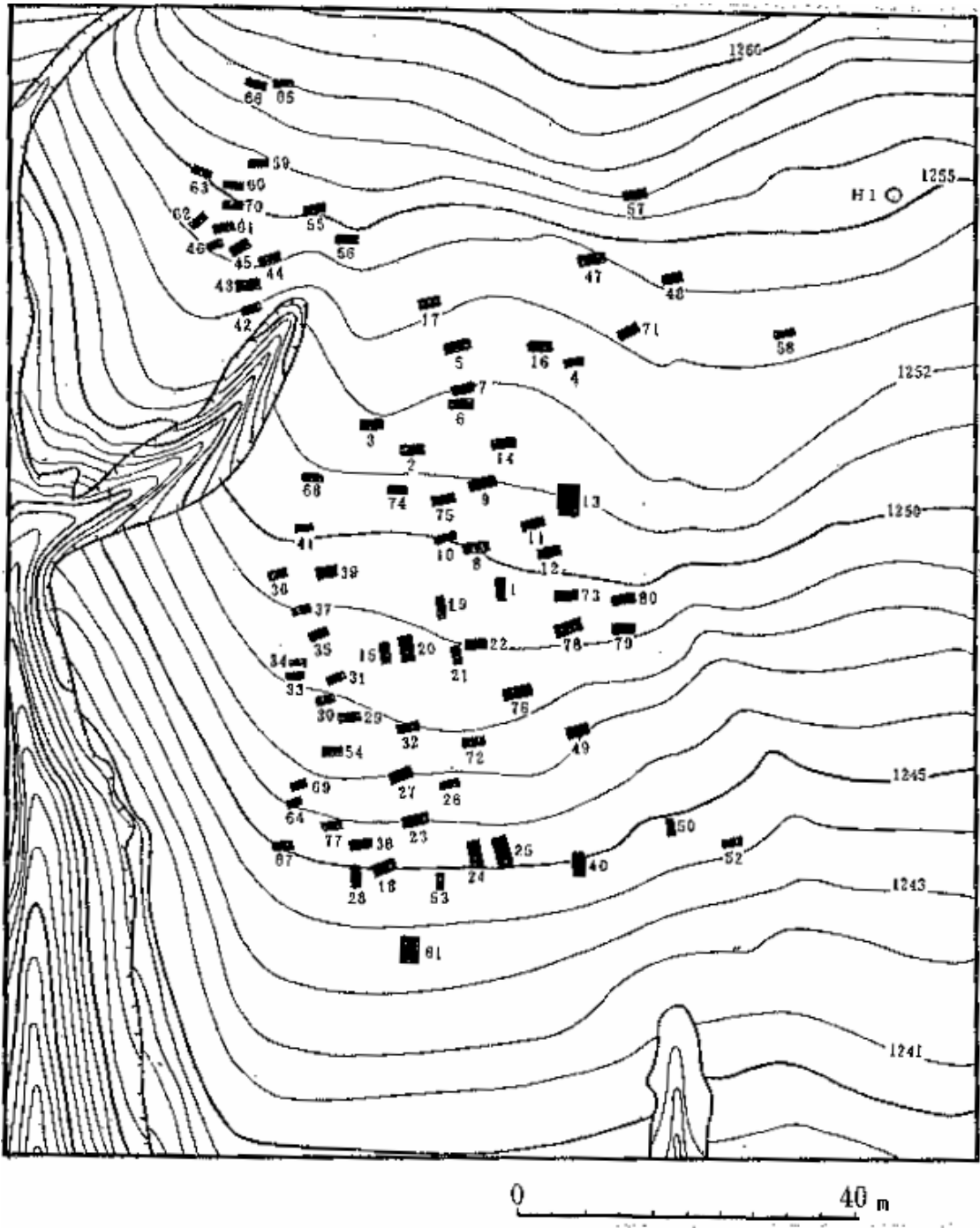


Fig. 085e. Maoqinggou, distribution of the tombs (after NMGG 1986, 231, Fig. 2)

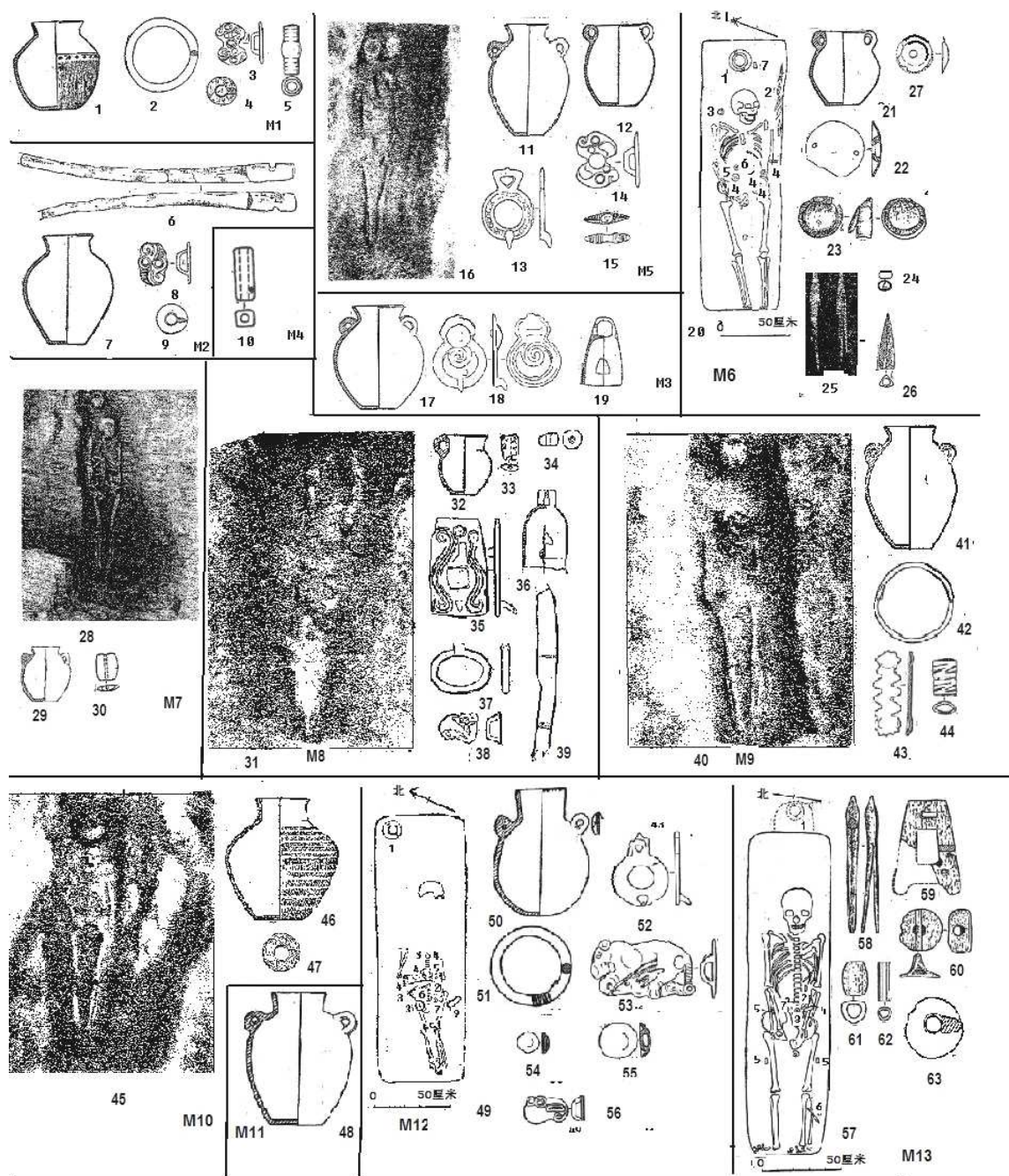


Fig. 086a. Guoxianyaozi, tombs and funeral goods, 1-5 Tomb M1; 6-9 Tomb M2; 10 Tomb M4; 11-16 Tomb M5; 17-19 Tomb M3; 20-27 Tomb M6; 28-30 Tomb M7; 31-39 Tomb M8; 40-44 Tomb M9; 45-47 Tomb M10; 48 Tomb M11; 49-56 Tomb M12; 57-63 Tomb M14-1: 1.7.11.12.17.21.29.32.41 pot, H 22cm.26.8cm.26.2cm.20cm.24.4cm.19.2cm; 2 bronze loop, dm 5.3cm; 5.8.14.38 plaque, L 3.3cm.3.cm.3.3cm.2.1cm; 4 ring, dm 2.2cm; 5 tube, L 2.9cm; 6 bone bow-end, L 24.3cm; 9 loop, dm 2.2cm; 10.30.33.34 turquoise, L 1.6cm.1.8cm.1.4cm.0.95cm; 13.18 buckle, L 5.4cm.7.1cm; 14 plaque, L 3.3cm; 15 crane hack, L 3.4cm; 19.36 bell, L 5cm.4.7cm; 22 buckle, dm 4.7cm; 23 bone ornament, dm 3.2cm; 25 arrowhead, L 4.2cm; 27 button, dm 2.7cm; 35 buckle, L 6cm; 42 loop, dm 3.6cm; 39 knife, L 12.6cm; 43 bead, L 5.1cm; 44 tube, L 2.2cm; 46.48.50 pot, H 27.6cm.24.4cm.23.2cm; 51 loop, dm 8.2cm; 52 buckle, L 5.2cm; 53 tiger plaque, L 7.6cm; 54.55 button, dm: 1.6cm.2.7cm; 56 plaque, L 3.1cm; 58 bone arrowhead, L 9cm; 59 bone buckle, L 6.3cm; 60 bone ornament, dm 2.7cm; 61.62 bone tube, L 2.2cm.2.6cm; 63 stone loop, dm: 2.7cm (after NMGY 1989, 64 Fig. 10, 7; 69 Fig. 12, 5; 66 Fig. 11, 5.30; 72 Fig. 14, 13; 64 Fig. 10, 8; Fig. 11, 1; 69 Fig. 12,

10; 65 Fig. 9, 2; 64 Fig. 10, 3; 66 Fig. 11, 7.4.22; ?; 63 Fig. 9, 4; 66 Fig. 11, 11.31; 59 Fig. 3; 64 Fig. 10, 4; 66 Fig. 11, 13; 72 Fig. 14, 12; 66 Fig. 11, 26; 72 Fig. 14, 2; 63 Fig. 9, 7; 71 Fig. 13, 2; ; 64 Fig. 10, 1; 71 Fig. 13, 1.5; 66 Fig. 11, 12.32; 69 Fig. 12, 7; 66 Fig. 11, 3; 69 Fig. 12, 11; 63 Fig. 9, 1; 69 Fig. 12, 1; 66 Fig. 11, 18.24; 64 Fig. 10, 11; 63 Fig. 9, 5; 61 Fig. 8; 63 Fig. 9, 8; 66 Fig. 11, 9; 69 Fig. 12, 4; 66 Fig. 11, 10.15.14.2; 59 Fig. 4; 72 Fig. 14, 1.10.11.7.8; 71 Fig. 13, 7).

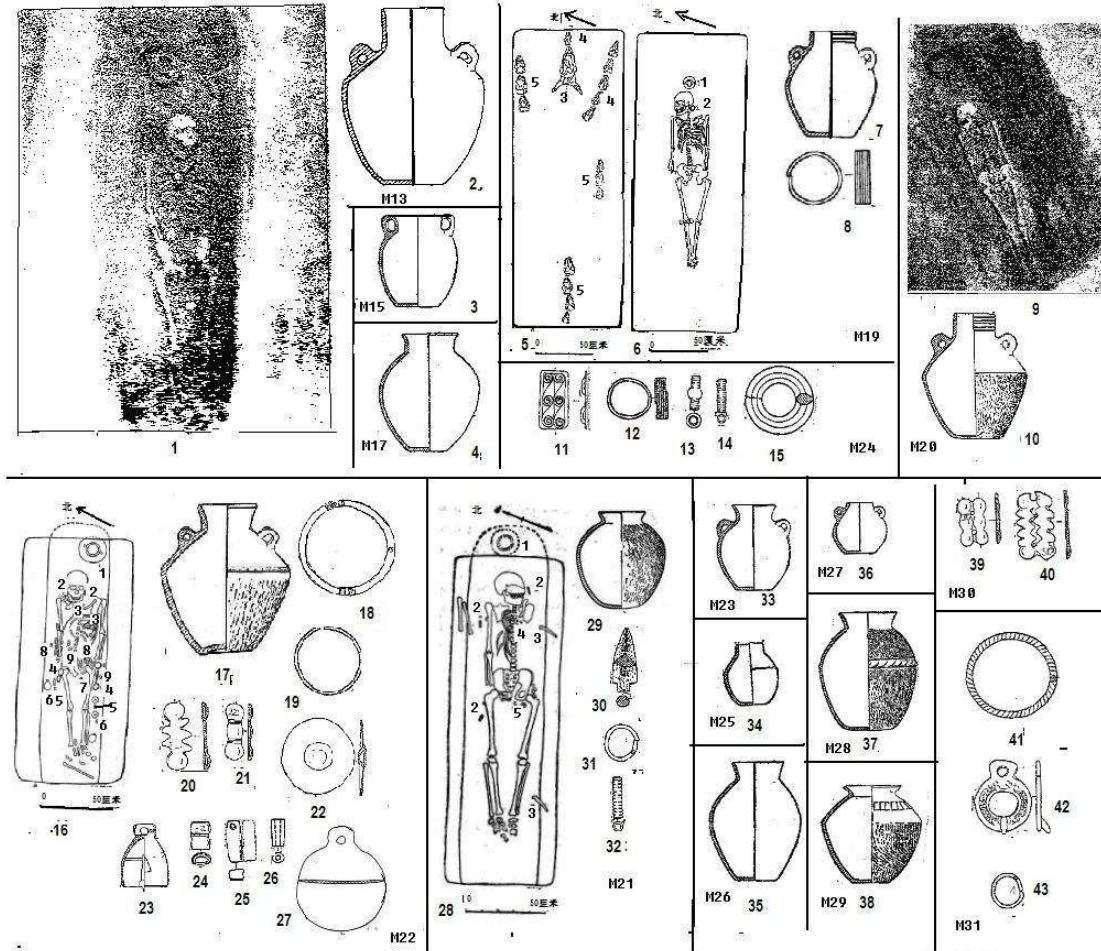


Fig. 086b. Guoxianyaozi, tombs and funeral goods, 1-2 Tomb M13; 3 Tomb M15; 4 Tomb M17; 5-8 Tomb M19; 9-10 Tomb M20; 11-15 Tomb M24; 16-27 Tomb M22; 28-32 Tomb M21; 33 Tomb M23; 34 Tomb M25; 35 Tomb M26; 36 Tomb M27; 37-38 Tomb M29; 39-40 Tomb M30; 41-43 Tomb M31---1-3.8.10.17.29.33-38 pot, H 25cm.20cm.28cm.16.4cm.20cm.30cm.8cm.27.6cm.25.6cm.14.4cm.28.6cm.12.4cm.28cm.23.2cm; 8.18.19 loop, dm 3.2cm.8.2cm.5.3cm; 20.21 bead, L 4.8-5.1cm; 23 bell, L 4.8cm; 30 arrowhead, L 4.7cm; 11 plaque, L 4.1cm; 12 loop, dm 2.8cm; 13.14 tube, L 3.6cm.4.8cm; 42, L 5.2cm; 43 loop, dm 2.4cm (after NMGY 1989, 63 Fig. 9, 9; 64 Fig. 10, 3.9; 61 Fig. 7; 60 Fig. 6; 63 Fig. 9, 10; 69 Fig.12, 6; 63 Fig. 9, 11; 60 Fig.5; 63 Fig. 9, 12; 69 Fig.12, 13.2; 66 Fig. 11, 19.21.23.33.25; 71 Fig. 13, 6.4; 66 Fig. 11, 34; 59 Fig. 2; 64 Fig. 10, 12; 72 Fig. 14, 3; 69 Fig. 12, 9; 66 Fig. 11, 28; 63 Fig. 9, 3; 64 Fig. 10, 10.5; 63 Fig. 9, 6; 64 Fig. 10, 6.13; 66 Fig. 11, 20.17; 69 Fig. 12, 12; 66 Fig. 11, 8; 69 Fig. 12, 8).

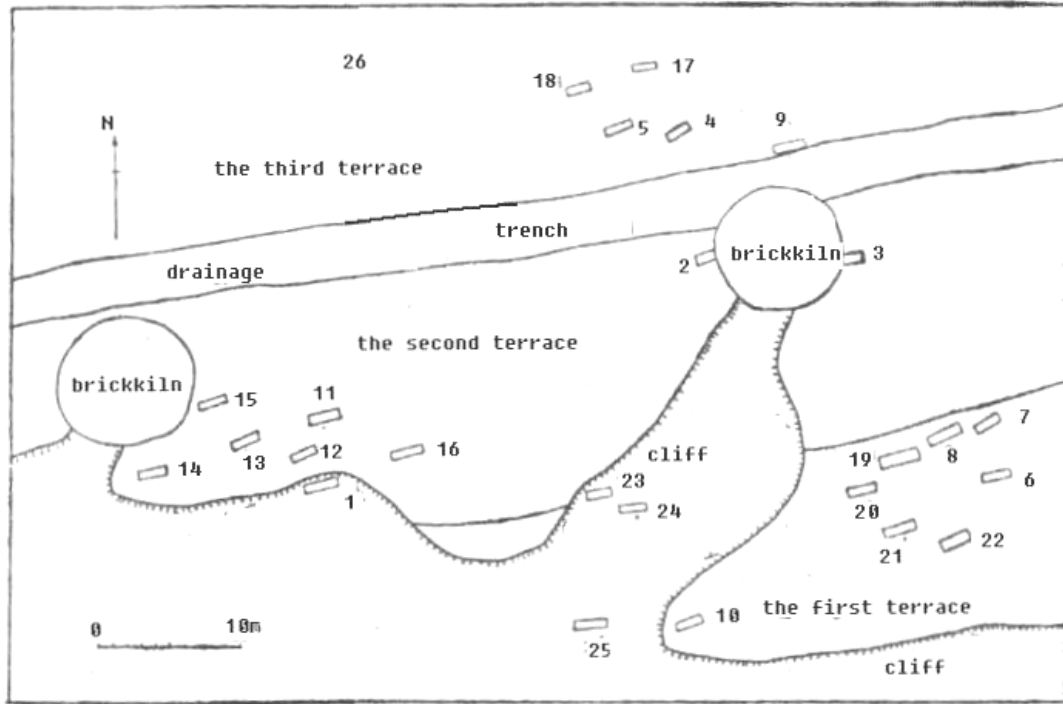


Fig. 086c. Guoxianyaozi cemetery, plan of tombs (adapted from NMGY 1989, 58 Fig. 1)

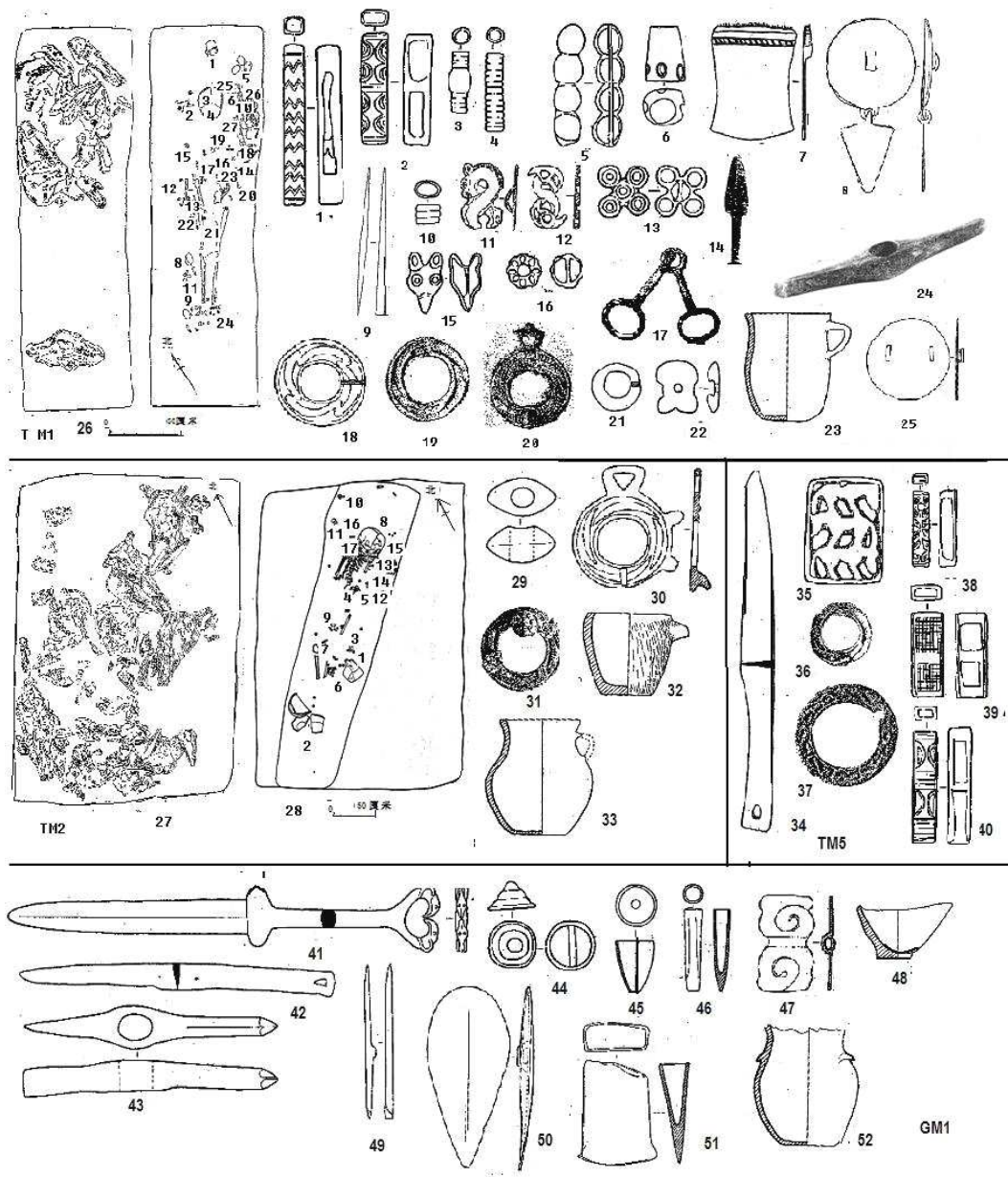


Fig. 087. Taohongbala, tombs and funeral goods, 1-26 TM1; 27-33 TM2; 34-40 TM5; 41-48 GM1-1-4. 38-40 tube, L 2.1-6.6cm; 5 bronze bead, L 5cm; 6,22 bone ware, L 3.3cm.2.7cm; 7 brush handle, L 6.3cm; 8 horse mask, L 15cm; 9,49 awl, L 10.6cm.8.6cm; 10 loop, dm 1.5cm; 11.12.47 plaque with double birds, L 3.4cm.3.2cm.4.6cm; 13.16.44 button, L 2.1cm.1.5cm. 2.1cm; 14 arrowhead, L 4.8cm; 17 bronze gag bit, L 20cm; 18.19, 31.36.37 loop, dm 3.8-6.4cm; 25 bone loop, dm 3cm; 24.43 crane hawk, L 14.3cm.14cm; 25 horse mask, dm 7.5cm; 23.33.48.52 pot, H 14cm.13.5cm.6.5cm.14.5cm; 26 pole head, L 4.2cm; 32 stone cup, H 10cm; 35 plaque, L 4.4cm; 41 sword, L 25.3cm; 45, L 3.2cm; 46 chisel, L 4.8cm; 50 horse mask, L 12.5cm; 51 axe, L 6cm (after Tian G. J. 1986, 212 Fig. 7, 1.5.8.9.13; 215 Fig. 8, 4.7.1; 210 Fig. 5, 4; 210 Fig. 5, 7; 211 Fig. 6, 3.5; 212 Fig. 7, 15; plate 47, 1; 212 Fig.7, 6.10; plate 99, 4; 211 Fig. 6, 2; plate 76,2; plate 7, 2; 215 Fig. 8, 5.6; 216 Fig. 9, 1; plate 39, 2; 215 Fig. 8, 2; 207 Fig. 3; 208 Fig. 4; 210 Fig. 5, 2; 211 Fig. 6, 6; plate 76, 3; 216 Fig. 9, 5.2; 210 Fig. 5, 9; 211 Fig. 6, 1; plate 76, 4.1; 212 Fig. 7, 5.2.4; 210 Fig. 5, 11.8.10; 212 Fig. 7, 14; 210 Fig. 5, 3.6; 211 Fig. 6, 4; 216 Fig. 9, 4; 210 Fig. 5, 5; 215 Fig. 8, 3; 210 Fig. 5, 1; 216 Fig. 9, 3).

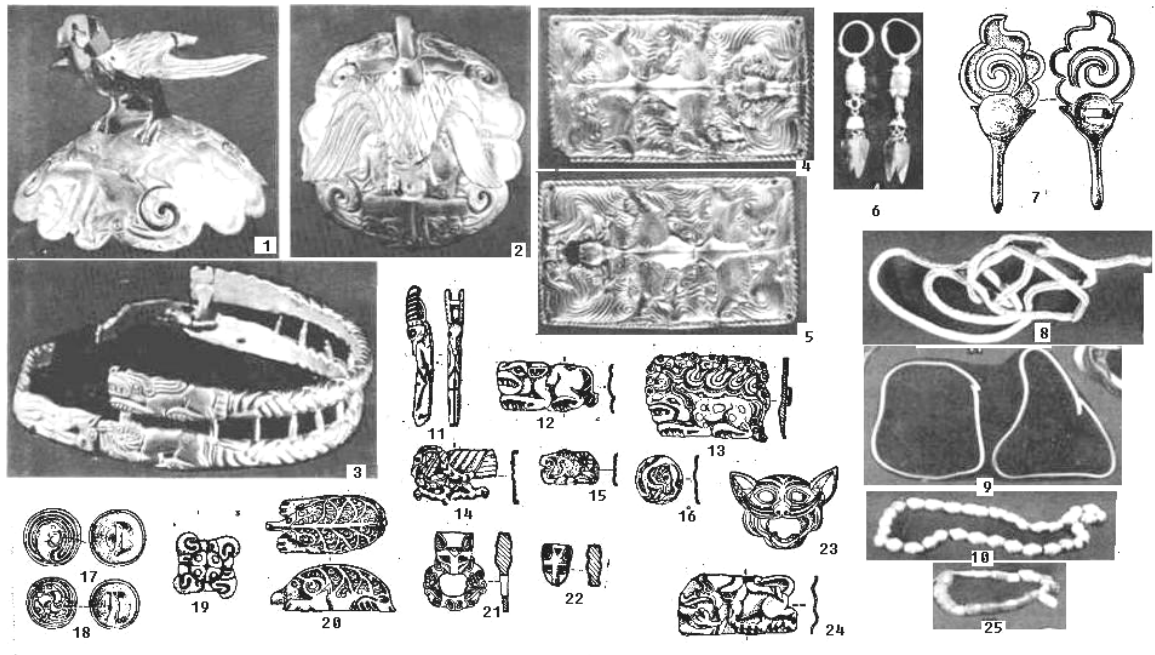


Fig. 088. Aluchaideng, metal objects, 1-22 gold objects; 23-24 silver objects; 25 stone necklace: 1-2 crown ornament, H 7.3cm, weight 192g; 3 crown belt, L 30cm, weight 1202g; 4-5 plaque with tiger and ox biting and fighting, L 12.6cm; weight 220.6g; 6 earring, L 8.2cm, weight 14.2g; 7 torch shaped needle, L 7.5cm; 9 necklace, L 1.3m; 10 bead necklace, weight 71g; 11 sheep ornament, L 5.3cm; 12 tiger ornament, L 3.9cm; 13 plaque with tiger and bird, L 4.5cm; 14 bird ornament, L 3.2cm; 15-16 sheep ornament, L 2cm.1.8cm; 17-19 button, L 2.2cm.1.9cm.2.4cm; 20 hedgehog, L 4.5cm; 21.22 tiger head shaped ornament, L 3cm.1.6cm; 23 tiger head, H 2.8cm, weight 16.4g; 24 ornament, L 4.5cm (after Tian/Guo 1980, plate 10, 1-5; plate 12, 4; 335 Fig. 3, 4; plate 12, 6.14.7; 335 Fig. 3, 1.6.11.3.7.8.14.15.9.12. 10.2.13.5; plate 12, 11).

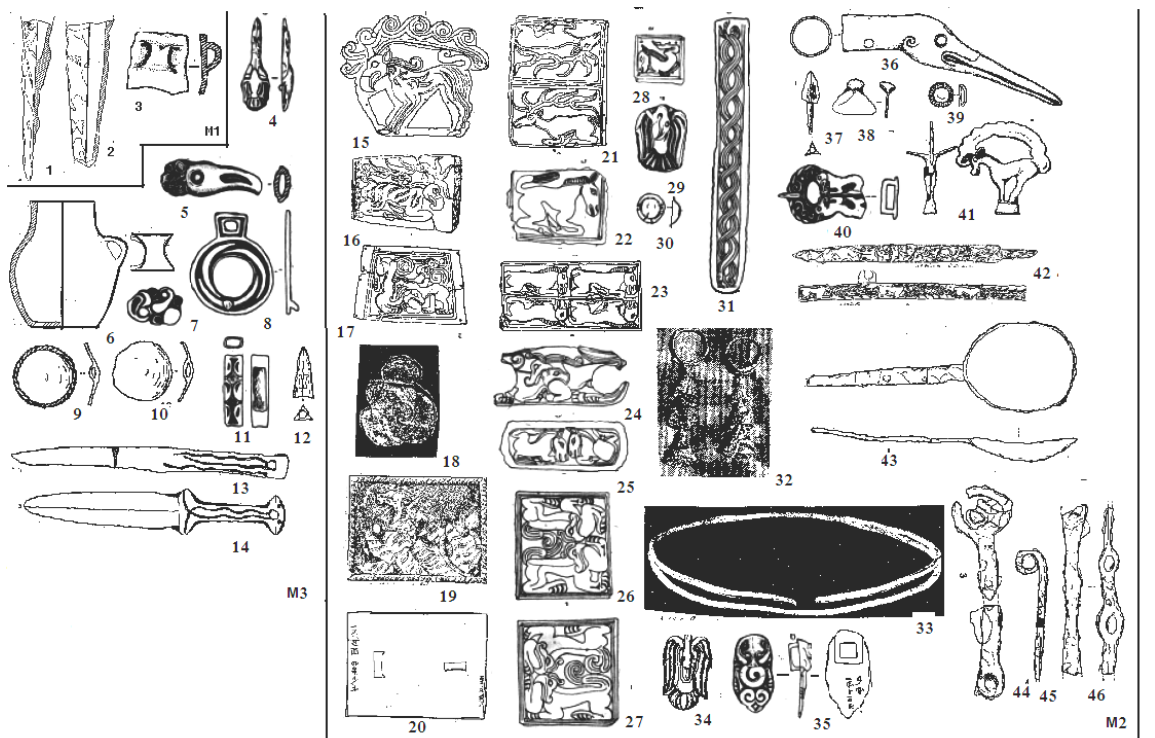


Fig. 089. Xigoupan, tombs and funeral objects, 1-3 Tomb M1; 4-14 Tomb M3; 15-46 Tomb M2, 1-2.42-46 iron ware, L 11.3cm.10.2cm.51.2cm.8.8cm.11.2cm.8.8cm.11.2 cm; 15-33 gold plaque and ornament: 15-17, L 12cm.9cm.6.3cm; 19-31, L 13cm.13cm.12.9cm.9.6cm.11.7cm. 9.1cm.9cm.7.6cm.7.6cm.3.4cm.4.7cm.2cm.19.8cm; 33, L 14.2cm; 6 pottery, H 6.5cm; 34 lead bird, L 6cm; 38 lead ware, L 2.7cm; 35 silver Jieyue, L 5.5-6cm; others are bronzes: 4-5 bird-head, L 5.1cm.5.4cm; 7 bird plaque, L 2.9cm; 8 belt buckle, L 5.5cm; 9-10.39 button, dm 4.5cm.1.9cm.4.8cm; 11 tube, L 3.3cm; 12.37 arrowhead, L 3.5cm.4.9cm; 13 knife, L 21.5cm; 14 sword, L 20.8cm; 36 pole top, L 18cm; 40 buckle, L 4.7cm; 41 deer, L 7.3cm (after YKW et al. 1986, 362 Fig. 10, 1.2; 363 Fig. 11, 1; 361 Fig. 9, 6.2; 363 Fig. 11, 2; 361 Fig. 9, 3.1; 360 Fig. 8, 10.11; 361 Fig. 9, 5; 360 Fig. 8, 5.3.2; 356 Fig. 4, 1.3.4; YKW et al. 1980, 7 Fig.17; YKW et al. 1986, 353 Fig. 2; 356 Fig. 4, 2.5.6; 356 Fig. 4, 6; 357 Fig. 5, 5; YWK et al. 1980, 3 Fig. 4, 1.2; YKW et al. 1986, 357 Fig. 5, 4.6.3.1; plate 4, 2; plate 55, 3; 357 Fig. 5, 6; 358 Fig. 7; 360 Fig. 8, 1.4.6.8; 357 Fig. 6, 1.2; 362 Fig. 10, 4.6.3.5).

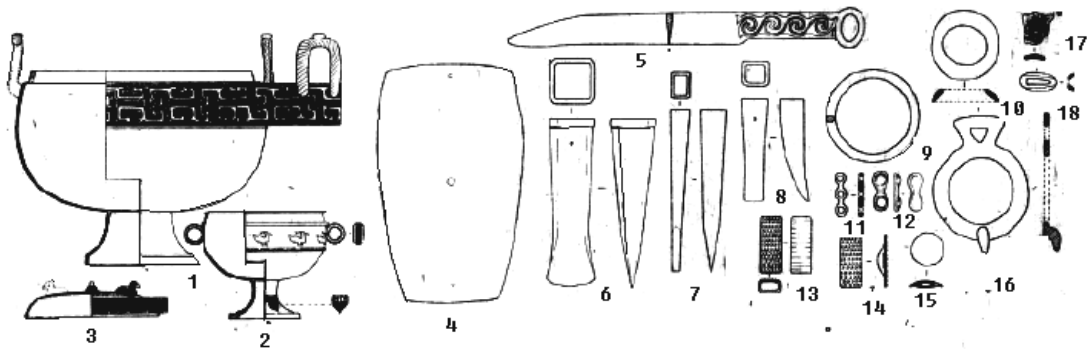


Fig. 090. Baihaishe, bronze objects, 1-2 Dou, H 30.2m.14.4cm; 3 cover, dm 17.4cm; 3 slide, L 15.7cm; 5 knife, L 23.5cm; 6 axe, L 11cm; 7.8 chisel, L 10.5cm.6.7cm; 9.10 loop, dm 6.2cm.4.8cm; 11.12 beads, H 2.8cm.2.5cm; 13 tube, H 3.7cm; 14 plaque, H 3.5cm; 15 bulb, dm 2.1cm; 16 belt buckle, L 8.9cm; 17.18, L 2.2cm.2.3cm (after YKW 1987, 80 Fig. 3, 1.3.2; Fig. 4; Fig. 6, 1.2.3.4.14.6.8.10.9.7. 13.5.11.12).

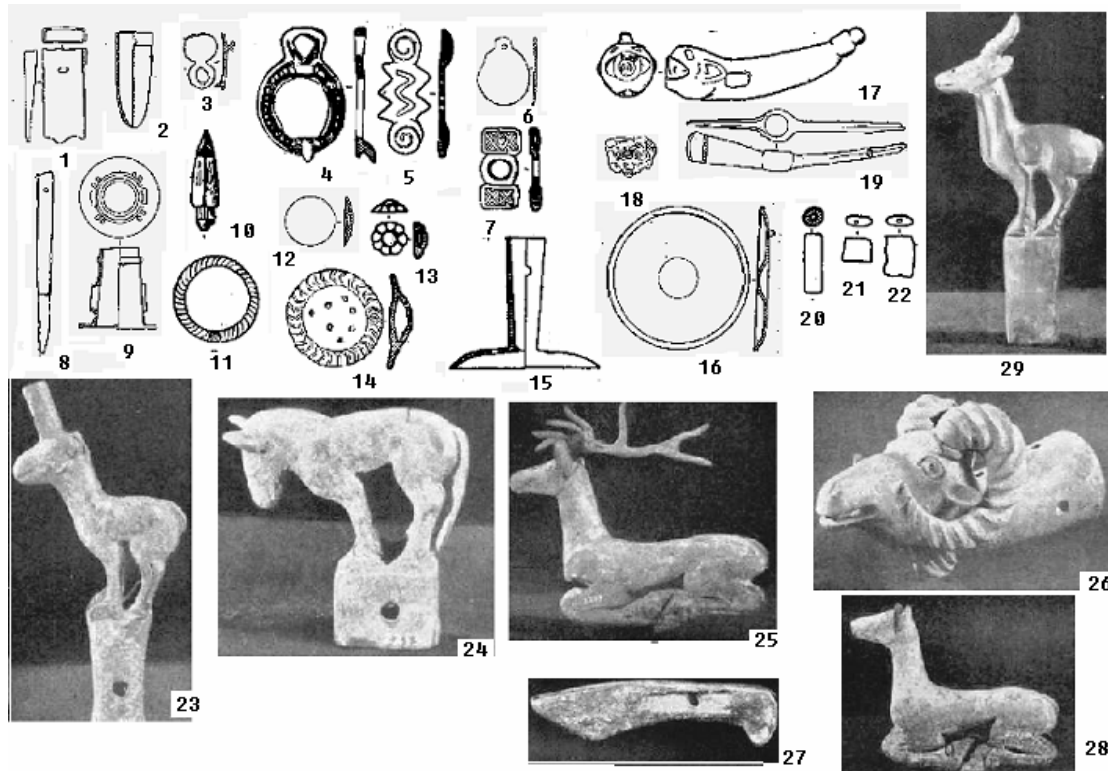


Fig. 091. Yulongtai, funeral objects, 1-16.23-29 bronze; 17 bone; 19 iron; 20-22 stone – 1 axe, L 10cm; 2 Dun, L 10cm; 3 belt buckle, L 5.4cm; 9 joint beads, L 5.1cm; 6.7 plaque, L 2cm.3.4cm; 8 knife, L 19.4cm; 9 head of axle, L 8.6cm; 10 arrowhead, L 4cm; 11 loop, dm 3.6cm; 12-14 button, dm 5cm.1.4cm.4.9cm; 15, L 5.3cm; 16 plaque, dm 15.3cm; 23-25 figure, L 14.4cm.6.6cm.11.4cm; 26 animal figure, L 19.5cm; 28.29 deer, L 9cm.17.4cm; 17 gag bit, L 8.2cm; 18 ornament, L 5.4cm; 19 crane hack, L 23.5cm; 20-22 stone beads, L 2.4cm.0.9cm.2.6cm (after NMGB et al. 1977, 112 Fig. 2, 1.2.4; 113 Fig. 3, 7.8; 112 Fig. 2, 3; 113 Fig. 3, 6; 112 Fig. 2, 7.10; 113 Fig. 3, 1.9; 112 Fig. 2, 8; 113 Fig. 3, 5.11.10; 112 Fig. 2, 9; 113 Fig. 3, 2.3.4; Plate. 2, 2; plate 3, 5; plate 2, 1; plate 3, 1.4.3.1).

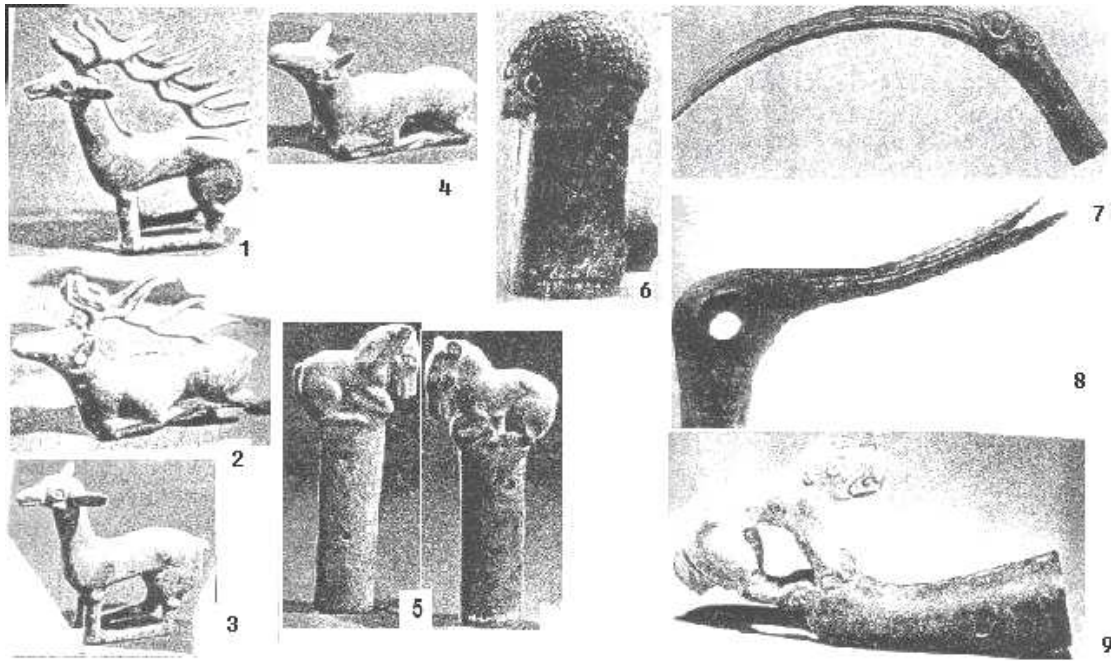


Fig. 092. Sujigou, bronze objects, 1-4 deer, H 16.7cm.12.4cm.12.5cm.7.7 cm; 5, H 16.5cm; 7-8 beak of bird, L 30.5cm.14.1 cm; 9 animal head, L 24.8cm (after Gai S. L. 1986, Plate 1; Plate 11; Plate 109; Plate 103, 1,2; plate 102, 2).

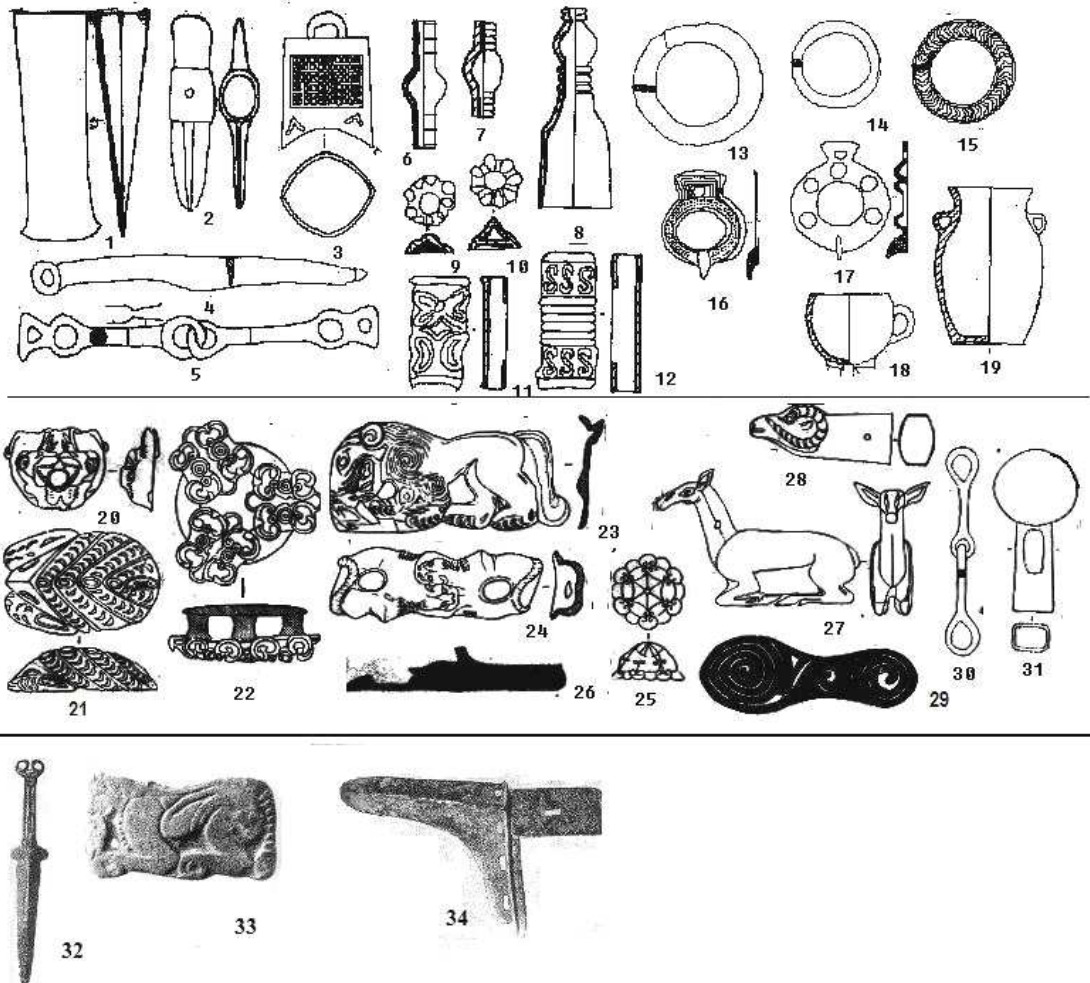


Fig. 093. Funeral objects, 1-19 from Minganmudu; 20-31 from Shihuigou; 32-34 from Fanjiayaozi (1-15.27.28.30-34 1bronze; 18.19 pottery; 20-25.29 silver objects) - 1 axe, L 13cm; 2 hack, L 11.2cm; 3 bell, L 7cm; 4 knife, L 19cm; 5 gag bit, L 20.8cm; 6-8 tube, L 3.5cm.2.6cm.5.5cm; 9-10 button, dm 1.4cm.1.6cm; 11.12 tube, L 3.3cm.3.7cm; 13-15 loop, dm: 5-7.4cm; 16-17, L 6.3cm.6.8cm; 18 pottery cup, H 8cm; 19 pot, H17.8cm; 20. 25 button, L 3.8cm.3.3 cm; 21 hedgehog, L 6.8cm; 22 tortoise ornament, dm 5.3cm; 23-24 plaque, L 10.4-9.8cm.8.65-8.85cm; 26 bird head, L 22.2cm; 27 deer, L 7.9cm; 28 animal, L 18.3cm; 29 insole-shaped ornament, L 25.2cm; 30 gag bit, L 12.6-12.9cm; 31 ornament, L 9.85cm; 31 sword, L 25cm; 33 plaque, L 5cm; 34 Ge, L 18.3cm (after YKW et al. 1992, 79 Fig. 1,1-5; 80 Fig. 80, Fig. 4, 1.3.2.5.6.4.7; Fig. 6, 5.4.6.7.3.2.1; YKW 1992, 92 Fig. 1, 1.3.4.5.6; 93 Fig. 3, right; 92 Fig. 1, 2; 93 Fig. 2, 2.1.3.4.5; Li Y .Y. 1986, Plate 29, 1; Plate 66, 9; Plate 43, 3).

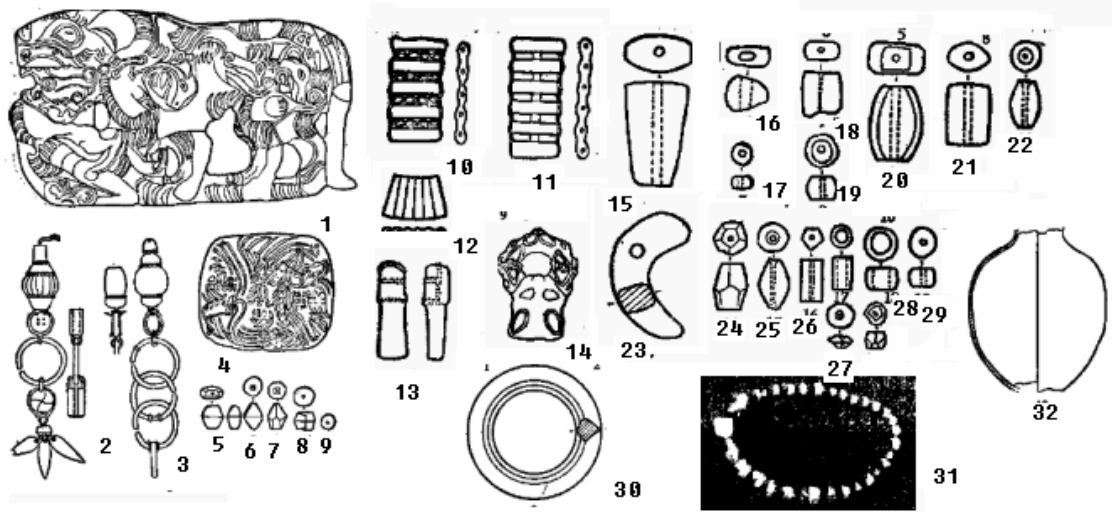


Fig. 094. Nianfangqu, gold and silver objects from hoard, 1-14.31 golden objects; 15-22 turquoise beads; 23-30, agate; 32 pottery--1 plaque, L 13.8cm; 2-3 earring, L 9.6cm.9.6cm; 4 ornament, L 5.3cm; 5-8 bead, L 0.6-1cm; 10-13 tube, L 2.7cm.2.9cm.1.1cm; 13 gold plated agate ornament, L 1.8-3.3cm; 14 gold plated iron animal shaped ornament, L 2.65cm; 15-29 bead, L 1.9-6cm; 30 agate loop, dm 5.3cm; 32 pot, H 26cm (after YKW 1991, 406 Fig. 2; Fig. 3, 1-8; 407 Fig. 4, 1.2.5-12.3.4.13-22; 406 Fig. 3, 9; 408 Fig. 5, middle; 406 Fig. 3, 10).

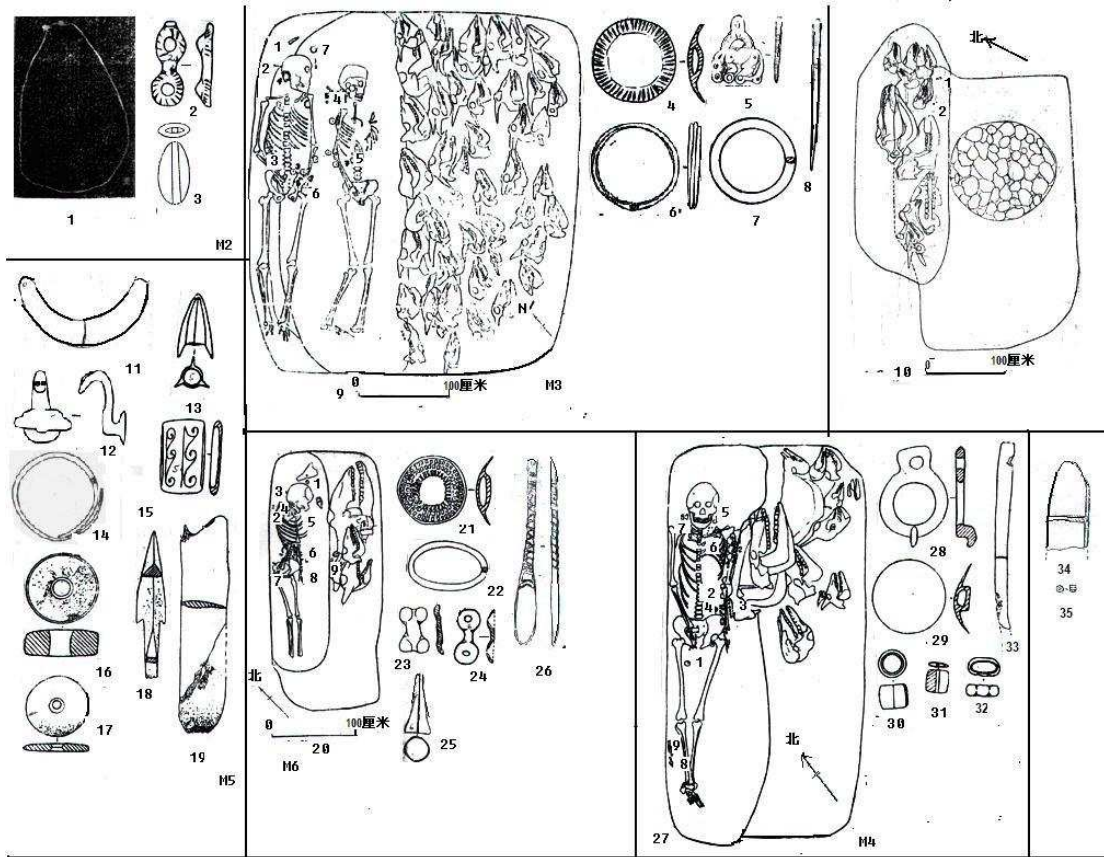


Fig. 095. Xiyuan, tombs and funeral objects, 1-3 Tomb M2; 4-9 Tomb M3; 10 altar pit; 11-19 Tomb M5; 20-26 Tomb M6; 27-33 Tomb M6; 34.35 Tomb M7 (3.16.18.19.34 bone; others bronze) - 3.16.18.19.34 bone ware, L 2.7cm.2.7cm.6-8cm.14cm.9cm; 2.23.24 bulb, L 2.6cm.2cm.2.9cm; 4.21 button, dm 3-3.3cm; 5 plaque, L 3.4cm; 6.14 earring, dm 4cm.3cm; 7 loop, dm 3.6cm; 12 belt hook, L 3cm; 13 arrowhead, L 2.5cm; 15 tube, L 2.6cm; 22 loop, dm 3.4cm; 25 bell, H 3.5cm; 26 spoon, L 9cm; 28 buckle, dm 3.4cm; 29 button, dm: 5cm; 30.33 tube, L 1cm.1.8cm; 31 stone ornament, L 1cm (adapted from Liu H. Z. 1991, 20 Fig. 8, 11; 18 Fig. 5, 10; 21 Fig. 9, 7; 18 Fig. 5, 1; 19 Fig. 6, 1; 18 Fig. 5, 13.4; 17 Fig. 4; 19 Fig. 6, 7; 18 Fig. 5, 15.14.12.6; 21 Fig. 9, 3.6.1.8; 15 Fig. 2, right; 18 Fig. 5, 3.5.11.9; 19 Fig. 6, 4; 15 Fig. 2, left; 19 Fig. 6, 2; 18 Fig. 5, 2.6; 21 Fig. 9, 5; 18 Fig. 5, 7; 19 Fig. 6, 5; 21 Fig. 9, 4).

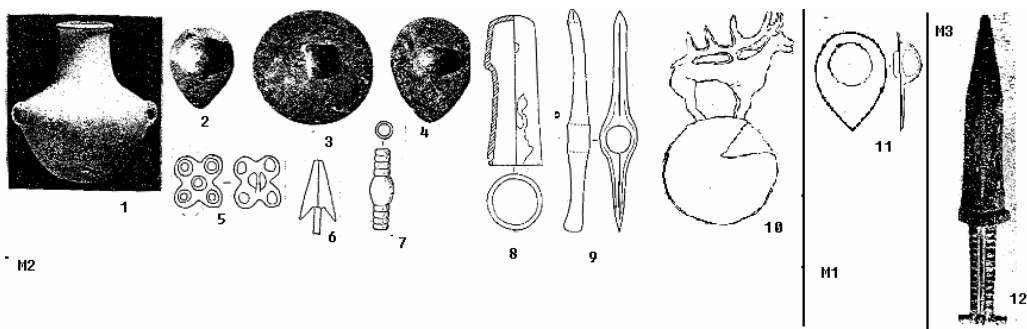


Fig. 096. Hulusitai, funeral objects, 1-10 Tomb M2; 11 Tomb M1; 12 Tomb M3 (1 pottery; others bronze) - 1 pot, H 26.5cm; 2-4.11 horse mask, L 5.9cm.12.8cm.5.9cm.6.3cm; 5 buckle, L 2.6cm; 6 handle, L 13.8cm; 9 crane hack, L 18.5cm; 10 deer, L 9.5cm; 12 sword, L 26.7cm (after Ta/Liang 1986, Plate 95, 2; Plate 100, 3.4.5; 224 Fig. 1, 3.2.1.5.4.6.7; Plate 28, 3).

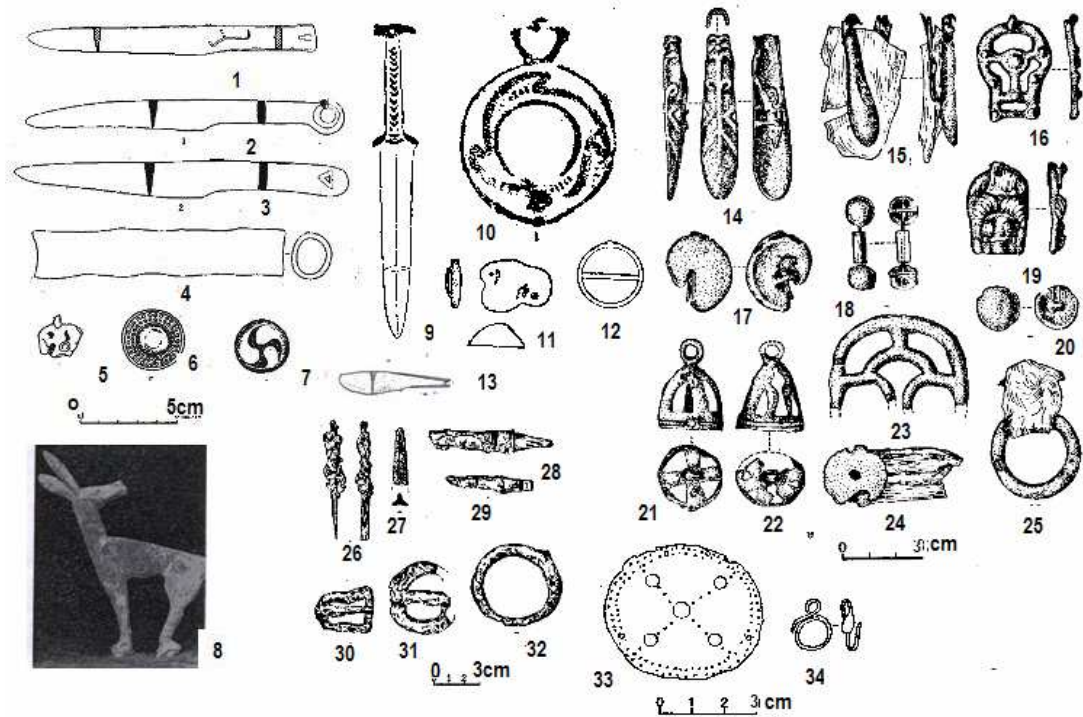


Fig. 097. Metal objects, 1 from Salaqi; 2-8 from Shuijiangoumen; 9-12 from Goulitou; 13 from Nanpaoziya; 14-34 from Chenbaerhuqi (26-32 iron; 33-34 gold; others bronze) - 1 knife L 19cm; 8 deer, L 11cm; 9 sword, L 25cm; 10, L 2cm; 11, dm 2cm; (after Shi Y. T. 1997, 18, Fig. 1; Zheng L. 1965, 51 Fig. 2, 1-6; Fig. 1; 9; Cui L. M. 1994, 473 Fig. 1, 1; Fig. 2, 1-3; after Hao W. B. 1996, 13 Fig. 2, 4; NMGG 1965b, 279 Fig. 8, 1-12; 280 Fig. 9, 1-7; 281 Fig. 10, 17.18).

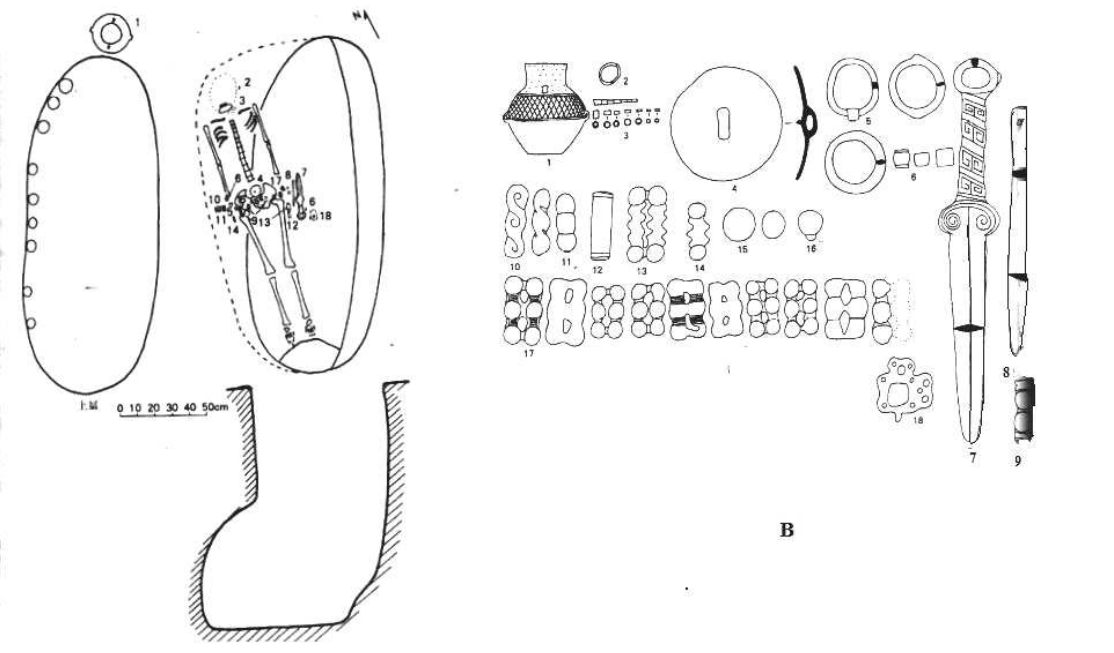
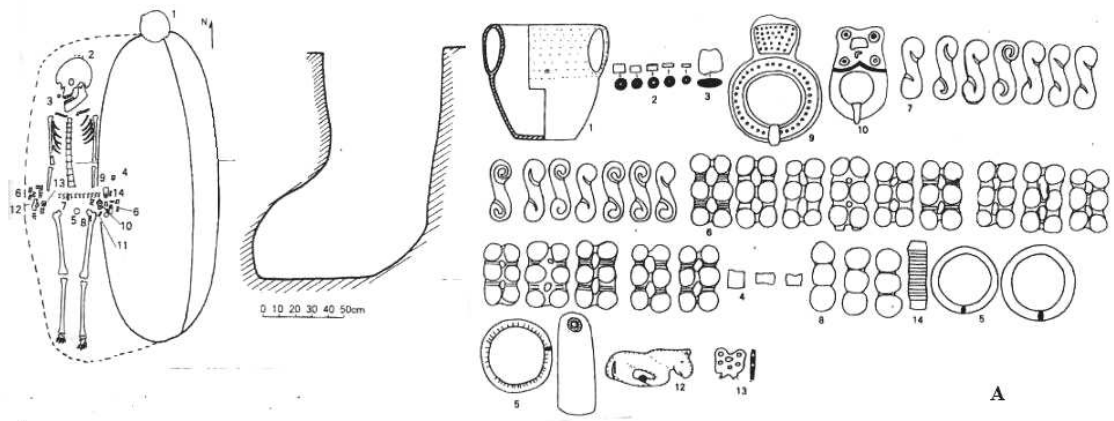


Fig. 098a. Chaiwangang, tombs and funeral objects, A Tomb M72; B Tomb M4 (after Xigangchaiwangang 2001, 117 Fig. 42; 118 Fig. 43; 119 Fig. 44; 120 Fig. 45).

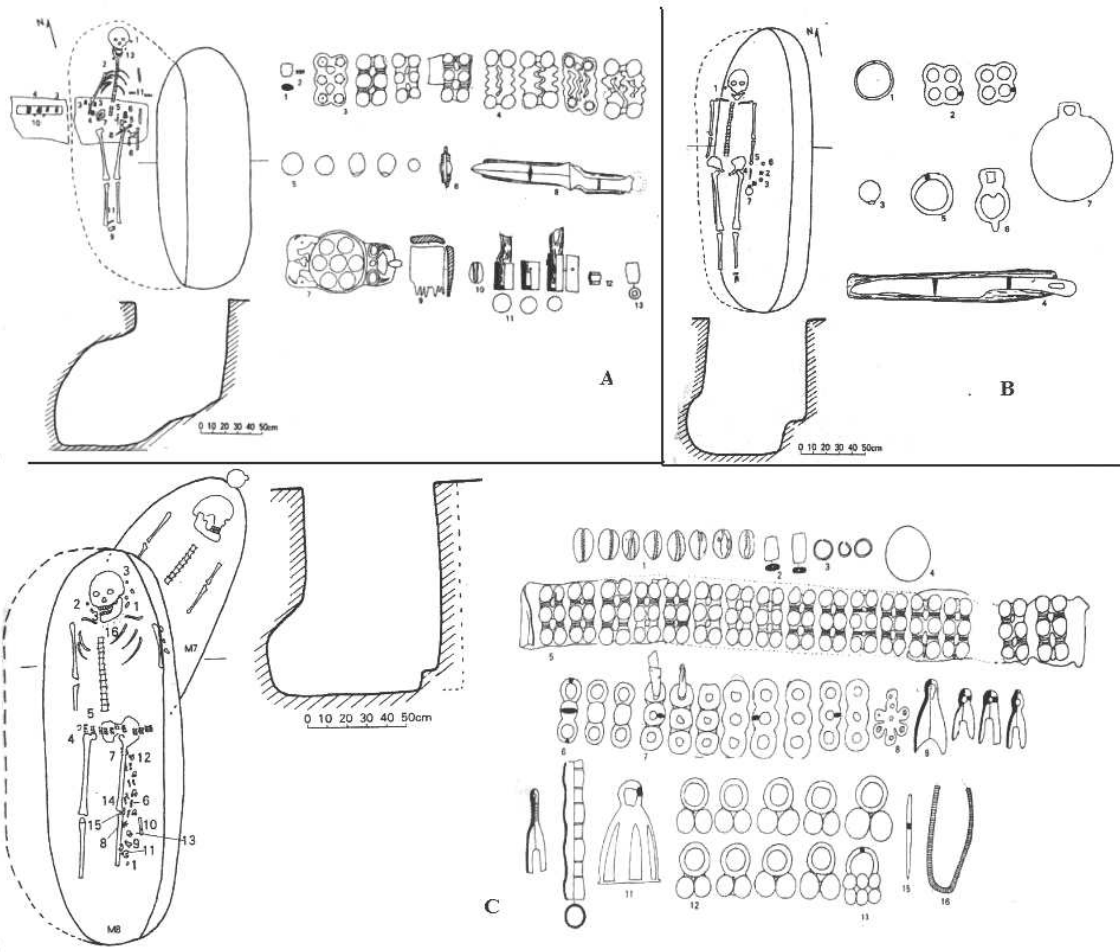


Fig. 098b. Chaiwangang, tombs and funeral objects, A Tomb M122; B Tomb M123; C Tomb M8 (after Xigangchaiwangang 2001, 122 Fig. 46; 123 Fig. 47; 125 Fig. 48; 126 Fig. 49).

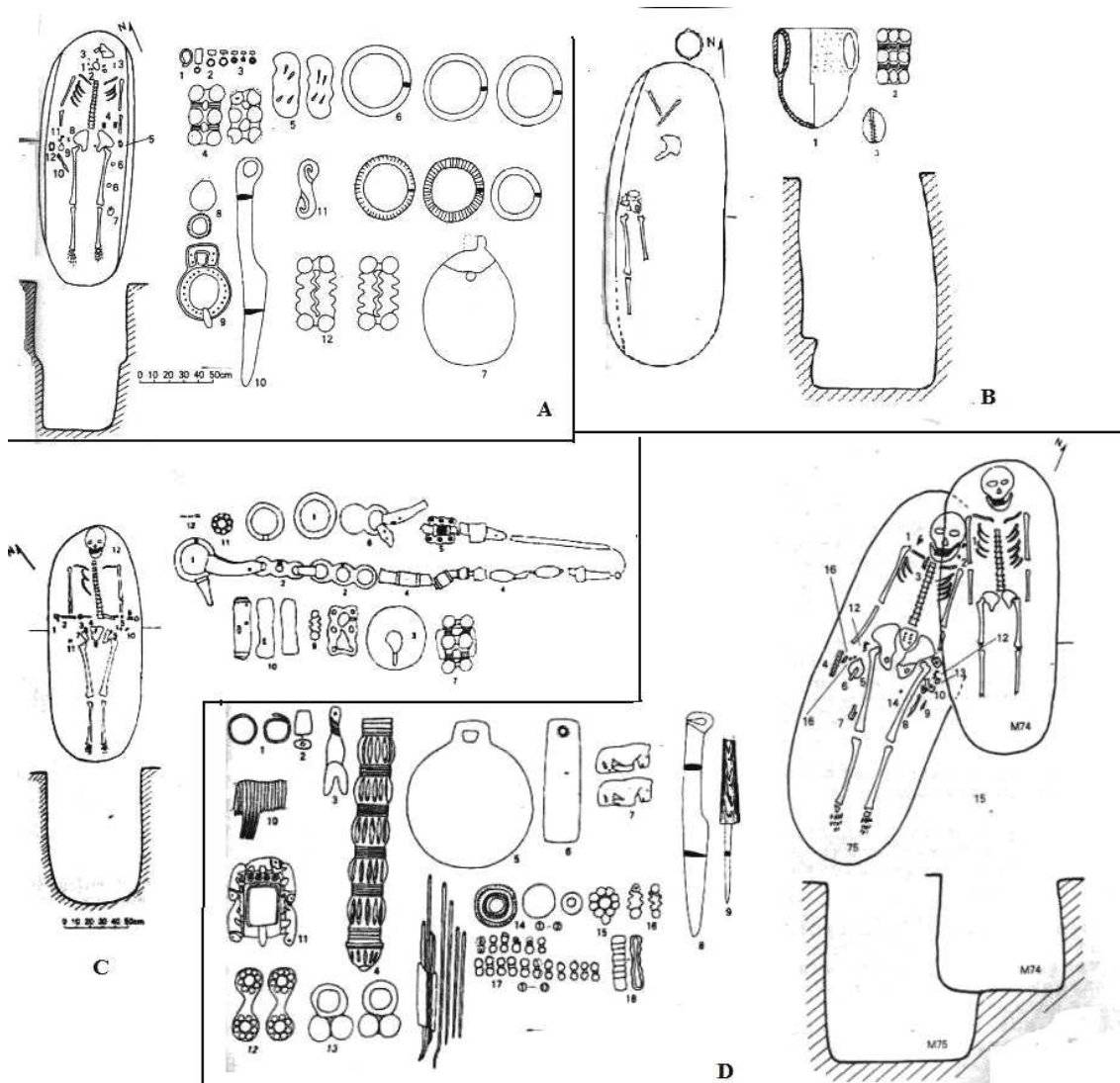


Fig. 098c. Chaiwangang, tombs and funeral objects, A Tomb M50; B Tomb M44; C Tomb M53; D Tomb M75 (after Xigangchaiwangang 2001, 127 Fig. 50; 129 Fig. 52; 131 Fig. 53; 133 Fig. 55; 132 Fig. 54).

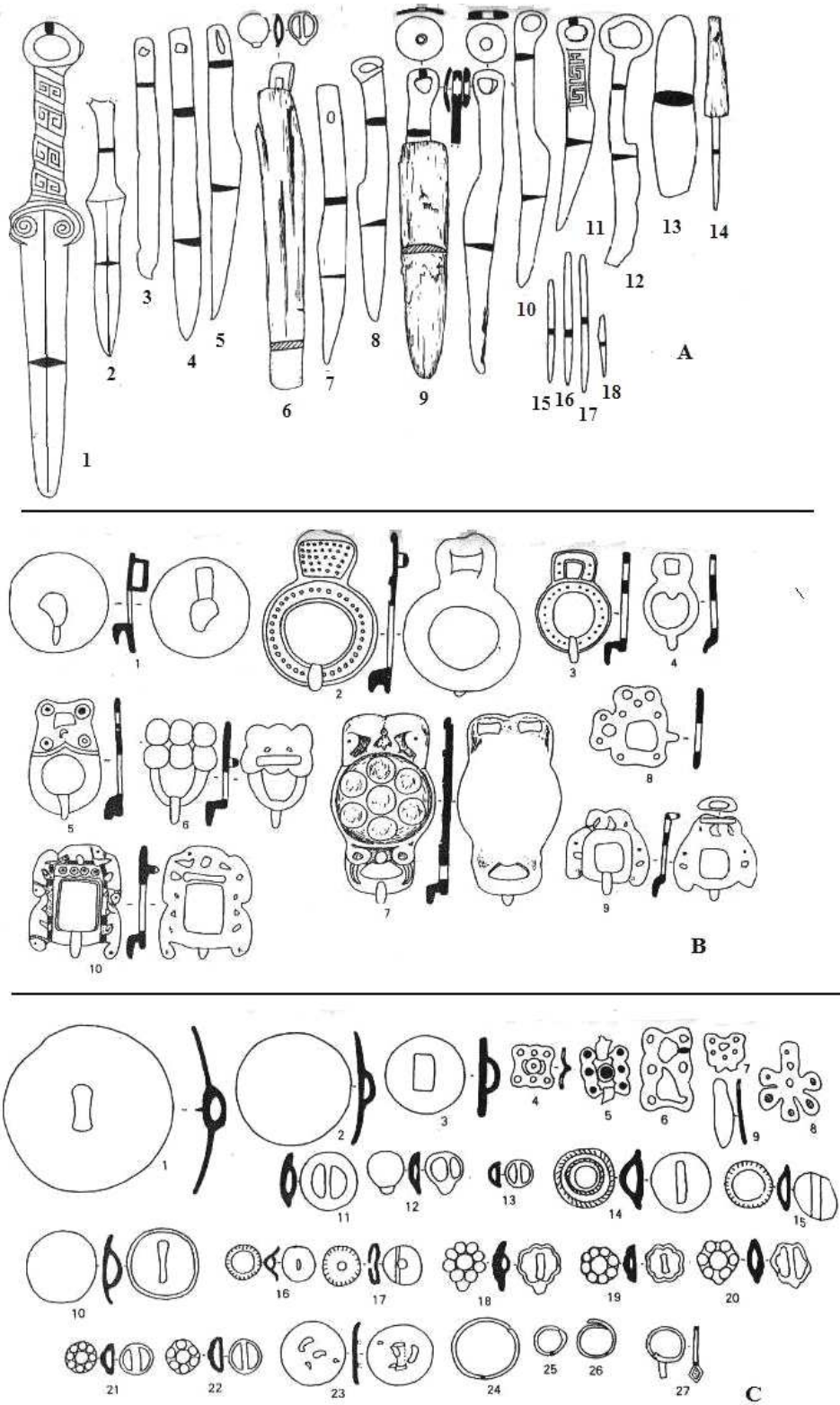


Fig. 098d. Chaiwangang, metal objects: A weapons and tools (13, iron; others, bronze) (after Xigangchaiwangang 2001, 149 Fig. 60); B buckles (after Xigangchaiwangang 2001, 151 Fig. 61). C ornaments (26, 27, gold; others, bronze) (after Xigangchaiwangang 2001, 169 Fig. 65).

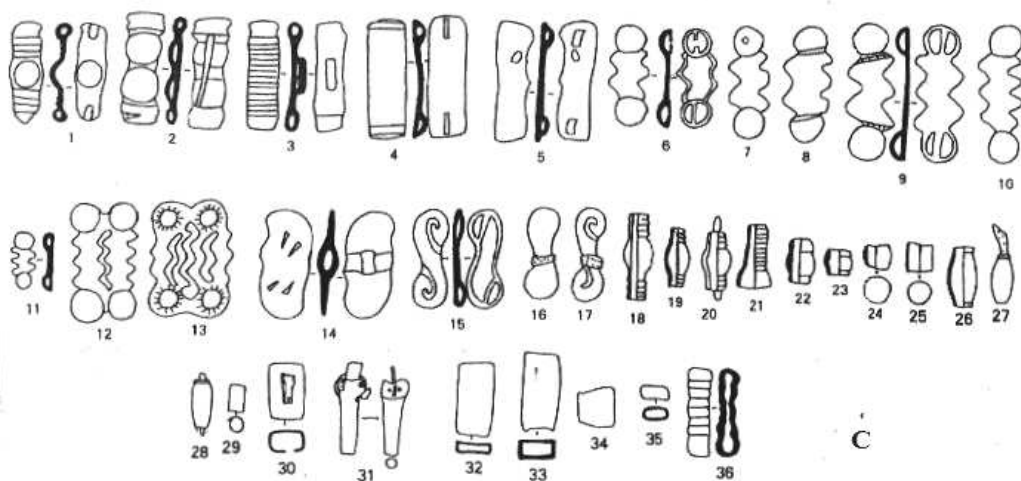
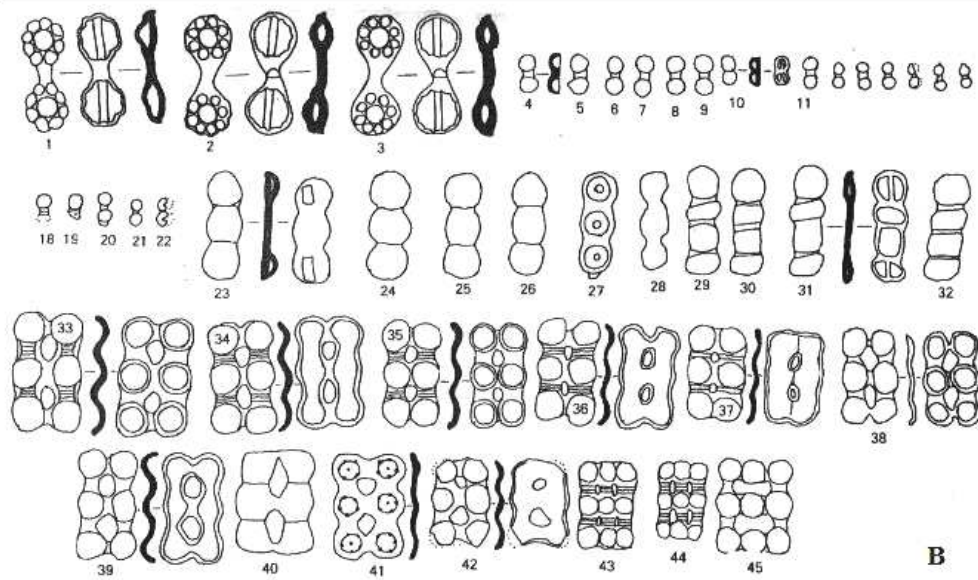
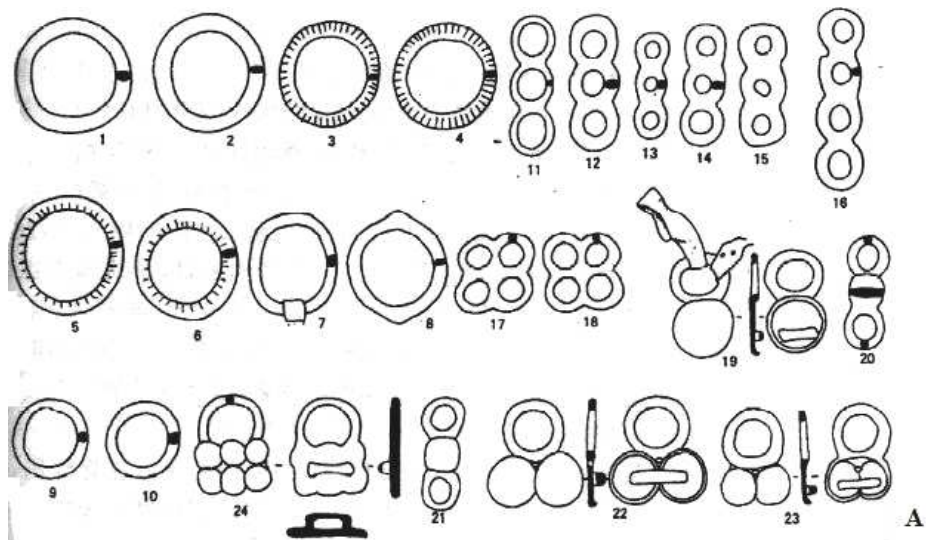


Fig. 098e. Chaiwangang, metal ornaments (after Xigangchaiwangang 2001, 153 Fig. 62; 157 Fig. 63; 162 Fig. 64).

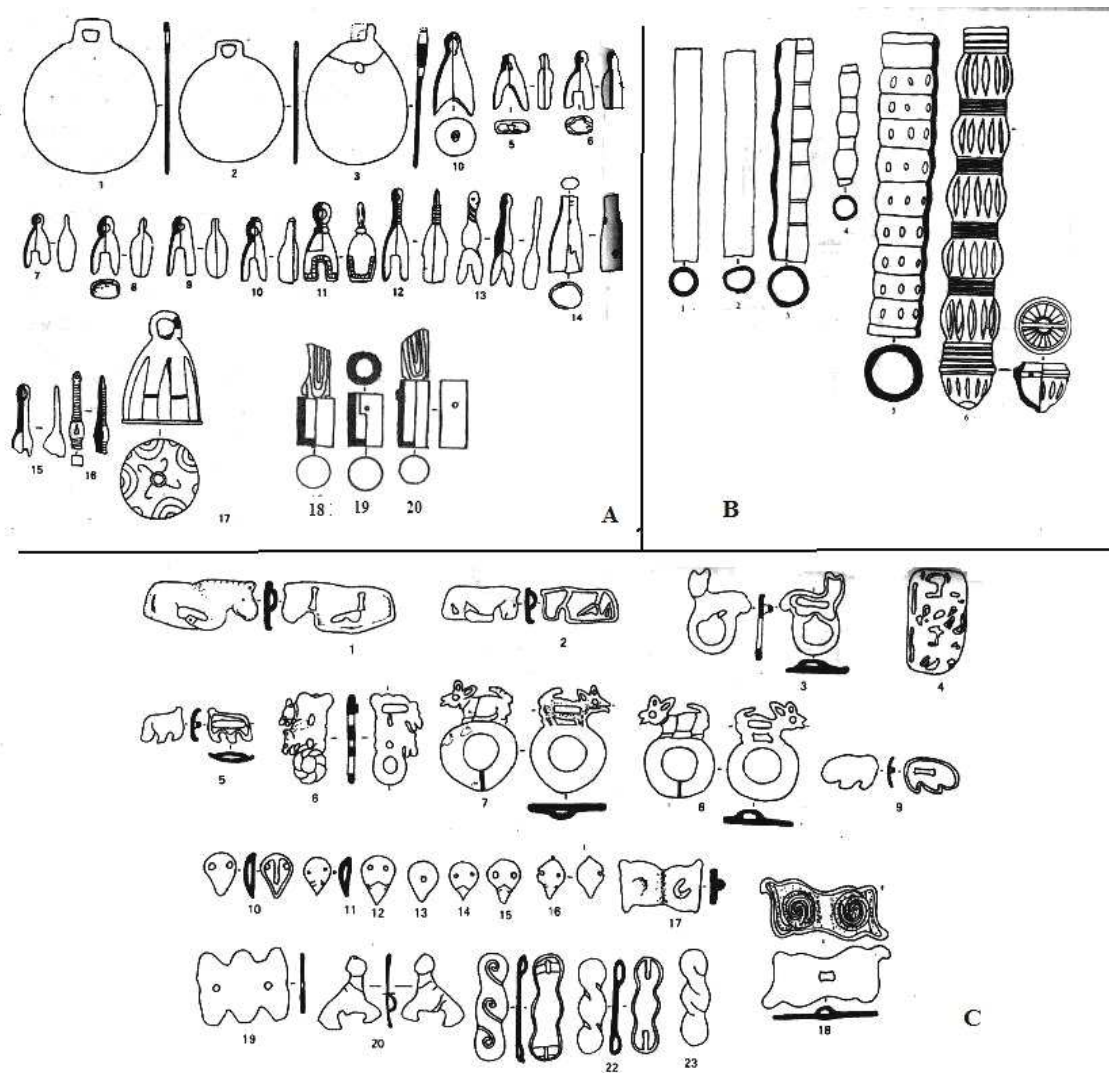


Fig. 098f, Chaiwangang, metal objects: A 1-3 mirror; 4-17 bell; 18-20 horse fitting (after Xigangchaiwangang 2001, 174 Fig. 66, 1-17; 182 Fig. 69, 15-17); B tube; C plaque (after Xigangchaiwangang 2001, 178 Fig. 68; 177 Fig. 67).

Period	stage	Liuwan	Huangniangniangtai	Qijiping	Qinweijia	Dahezhuang
I	1					
	2					
II	3					
	4					
III	5					
	6					
IV						

Fig. 099a. Qijia culture, relative periodization of sites: Liuwan, Huangniangniangtai, Qinweijia and Dahezhuang (adapted from Shui T. 2001a, 197 Fig. 3; 199 Fig. 4; 201 Fig. 5; 202 Fig. 6; 203 Fig. 7; 204 Table 4).

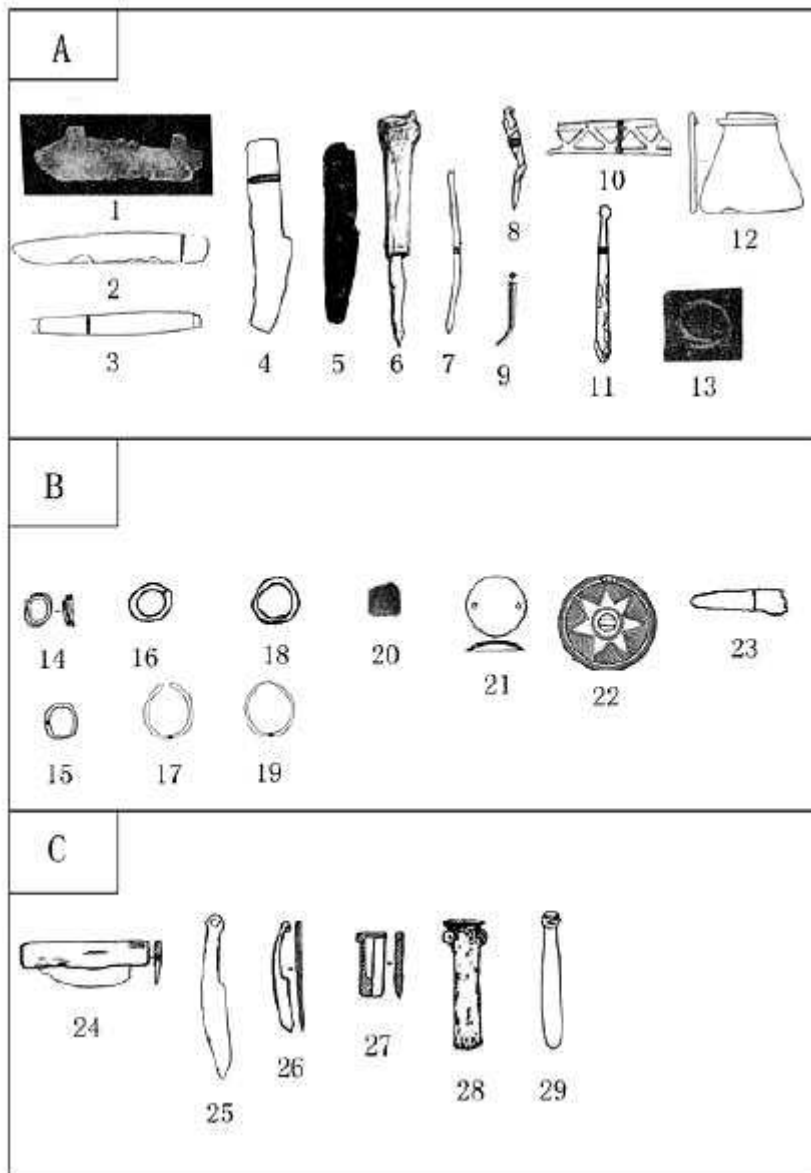


Fig. 099b. Qijia culture, copper and bronze objects, 1.4.7.8.9.10.11.13 from Huangniangniangtai; 2.3.6 from Zongzhai; 5 from Dahezhuang; 12.20 from Qinweijia; 14.15.22 from Gamatai; 16.18.23 from Zongri; 17.19.21 from Xinzhuangping; 24 from Weijiataizi; 25 from Shangguandi; 26.27 from Xinglin; 28.29 from Qijiaping.

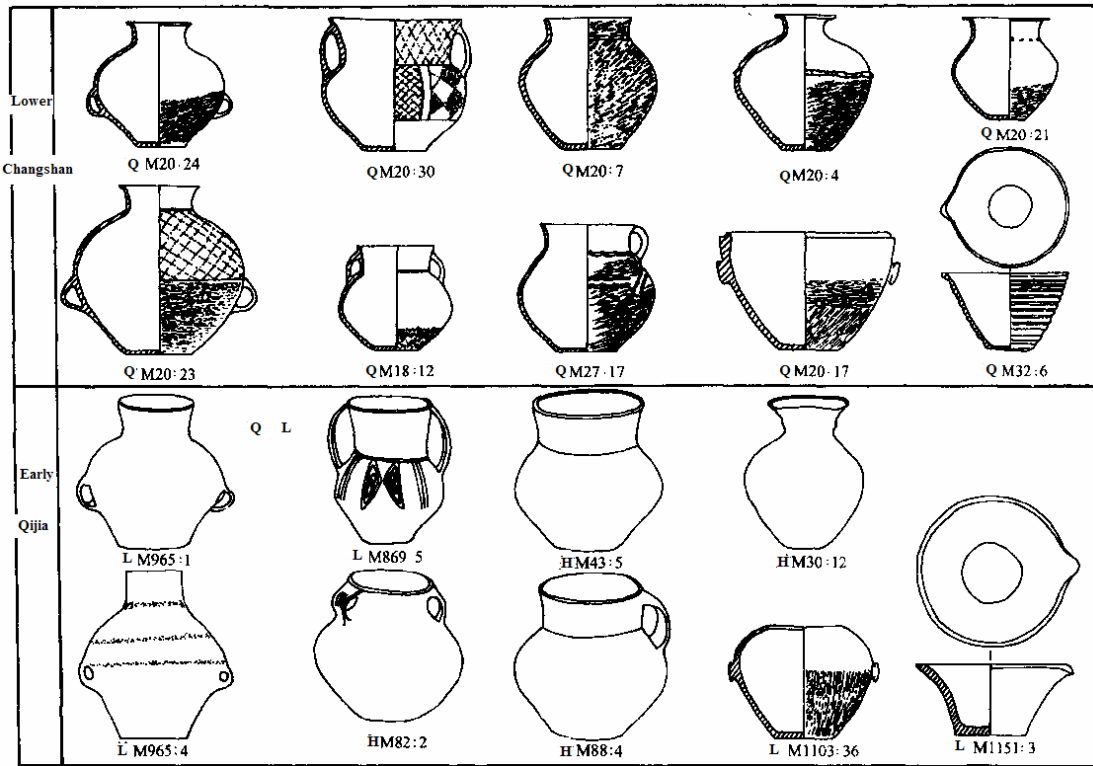


Fig. 099c. Qijia culture and Upper Changshan culture, potteries, Q, Qiedaoba cemetery; L, Liuwan cemetery; H, Huangniangniangtai cemetery (adapted from Shui T. 2001a, 275 Fig. 49).

		Shanjiatou	Lianhuatai	Yanchang	Xindian (etc.)
I	1				
	2				
II	3				
	4				
III	5				
	6				
	7				

Fig. 100a. Xindian culture, periodization of the sites: Shanjiatou, Lianhuatai, Yanchang, Xindian (adapted from Shui T. 2001a, 208 Fig. 9; 210 Fig. 10; 212 Fig. 11; 213 Fig. 12; 214 Fig. 13; 215 Fig. 14; 218 Table 9).




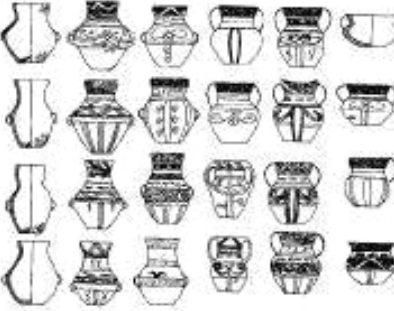



		Jijiachuan	Zhangjiazui	Hetaozhuang	Tang Wang chuan	Shang Sunjia zhai	Boji zhang	Liu wan
I	1						√	√
	2							
II	3							
	4							
III	5							
	6							
	7				√	√		

Fig. 100b. Xindian culture, periodization of the sites: Jijiachuan, Zhangjiazui, Hetaozhuang, Tangwangchuan, Shangsunjiazhai, Liuwan (adapted from Shui T. 2001a, 216 Fig. 15; 217 Fig. 16; 219 Fig. 17; 218 Table 9).

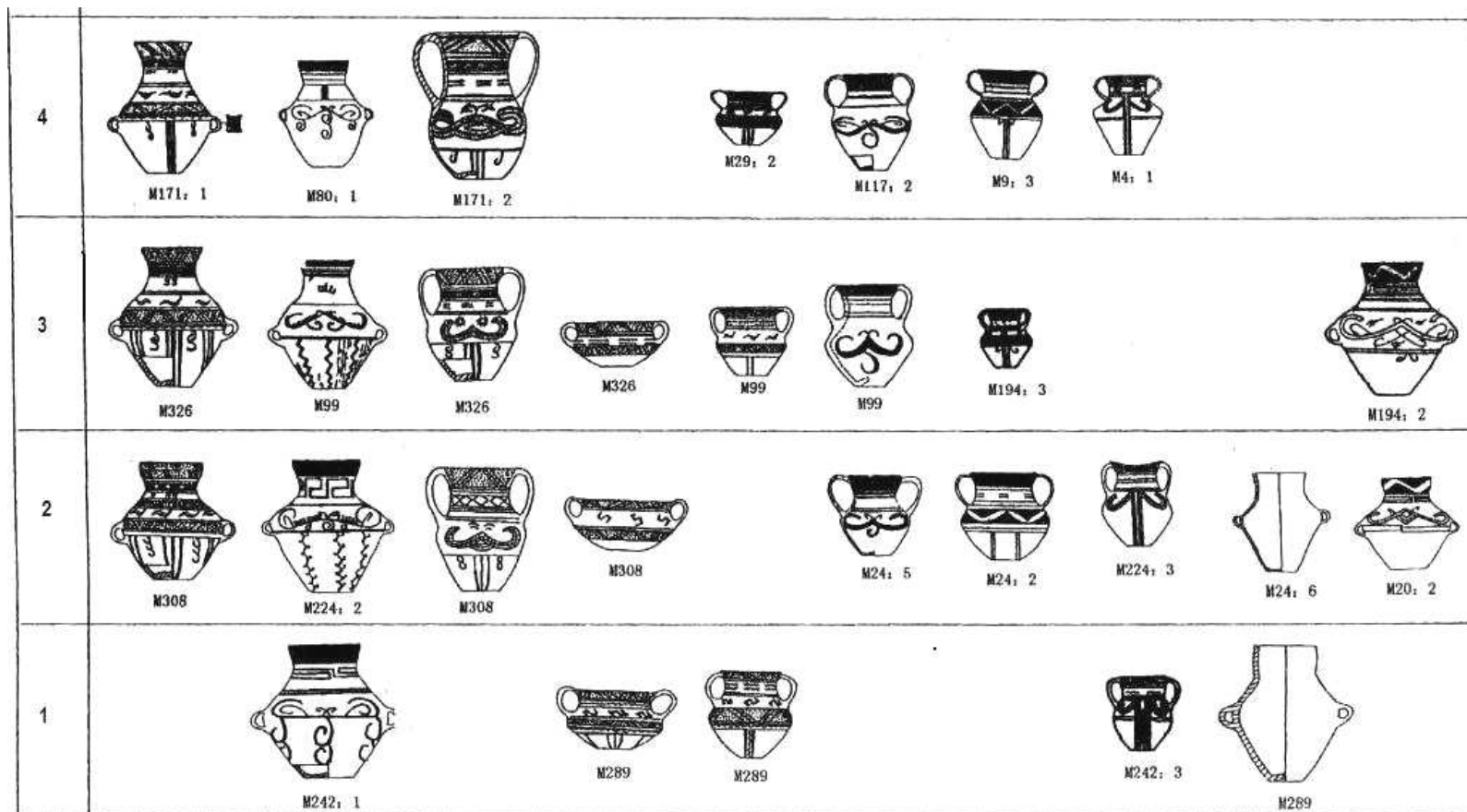


Fig. 100c. Xindian culture, Xiaohandi potteries (adapted from ZWL 2003, 146 Fig. 3.6).

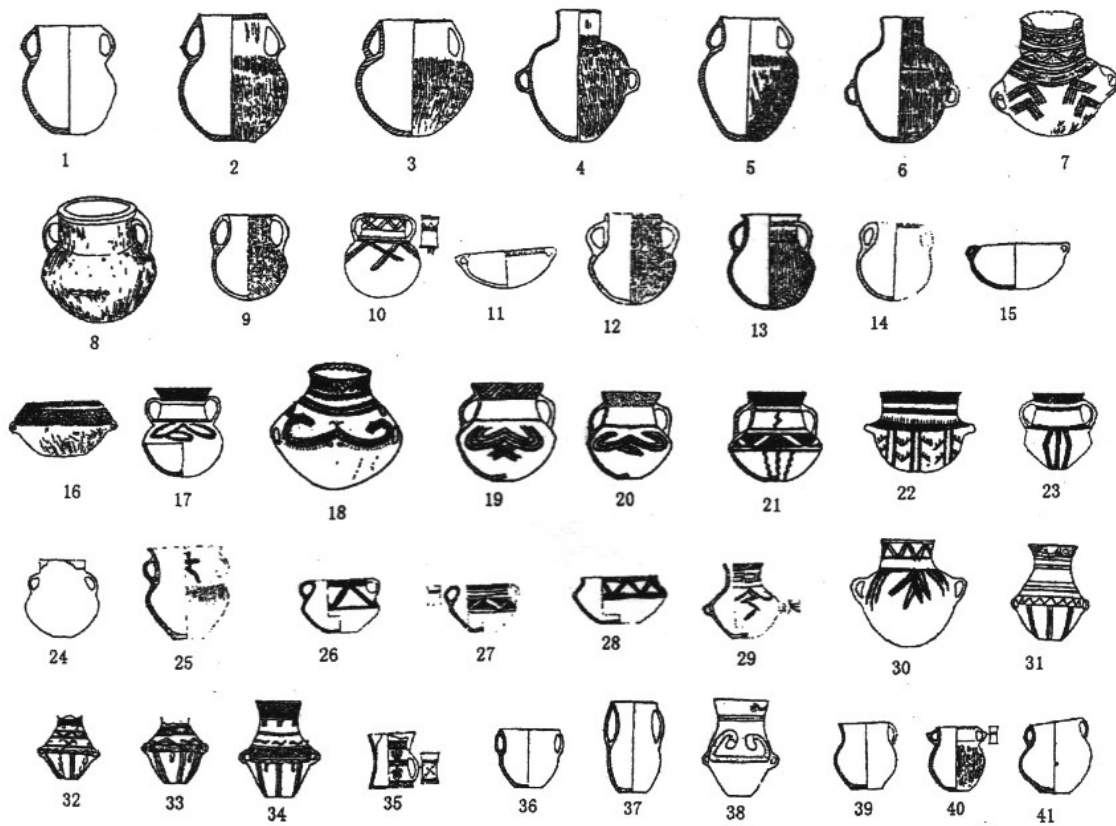


Fig. 100d. Xindian culture, potteries, 1-6 Liuwan; 7-17 Bojizhang; 18-23 Bianjiang; 24-29 Zhongchuan (collected); 30 Dongdapo; 31-33 Zhuandao; 34 Shanghandi; 35 Erfang; 36-38 Zongzhai M32; 39-42 Batan (after ZWL 2003, 147 Fig. 3.8).

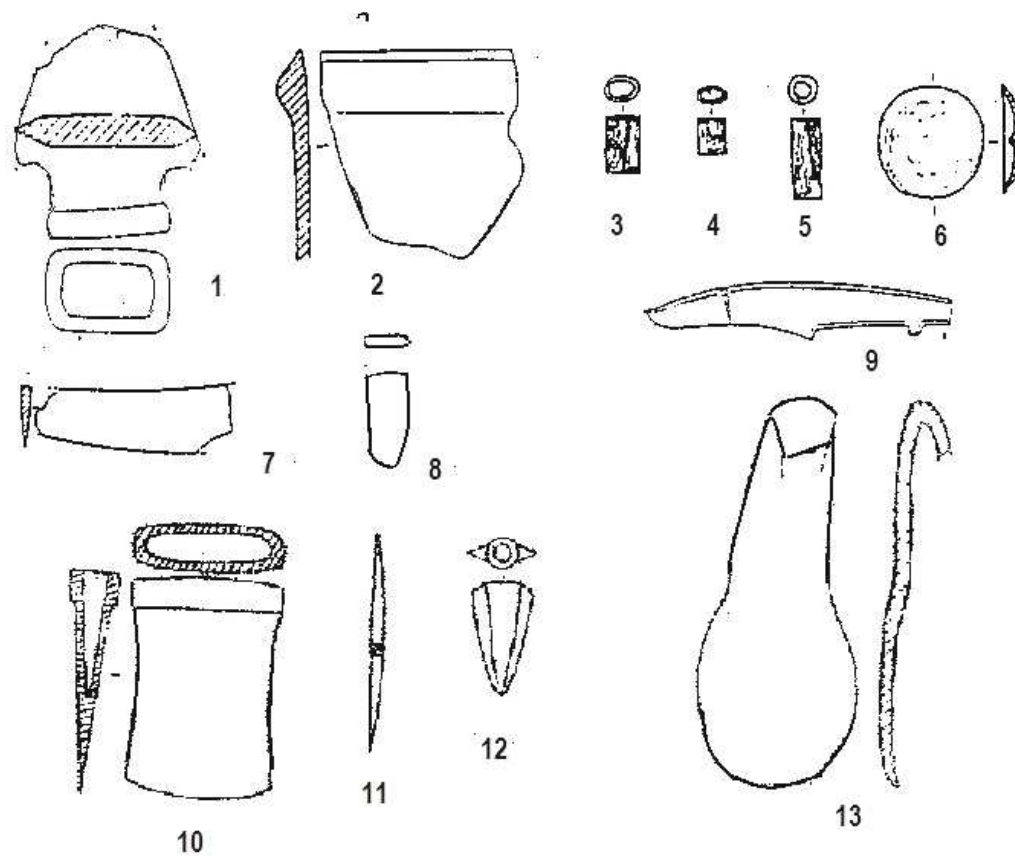


Fig. 100e. Xindian culture, bronze objects, 1-2 from Zongzhai; 3-9 from Lianhuatai; 10.11 Tuchangtou; 12 Shuangdongping; 13 Shanjiatou (after Pak Y. J. 1996, 290 Fig. 6.7, 1-9; ZWL 2003, Fig. 4.1, 1-4).

Period	Stage	Site		Panjialiang	Kayue Xiaxihe	Huangjiazhai	Dahuazhongzhuang
I	1						
	2						
II	3						
	4						
III	5						
	6						

Fig. 101a. Kayue culture, periodization of the Huangshui valley sites: Panjialiang, Xinxihe, Huangjiazhai and Dahuazhongzhuang (adapted from Shui T. 2001a, 234 Fig. 26; 233 Fig. 25; 241 Fig. 30; 239 Fig. 29; 240 Table 14).

Site		Ahatela	Shangbanzhuwa	Shanpingtai
Period	Stage			
I	1	 M132-8 M133-5 M133-3 M151-6	 BL502-1 BL50-2 BL503-2 BL50155-1 BL509-2	
	2	 M356-3 M36-1 M36-2 M207-5	 BL50M136-3 BL50M112-2 BL50M160-1 BL50M112-3	
II	3	 M11-1 M33-1 M53-4 M11-2 M182-2 M51-1	 BL50M180-1 BL50M151-2 BL50M173-2 BL50M179-3	 M48-2 M99-3 M93-1 M87-1 M87-2 M66-1
	4	 M114-5 M76-2 M183-8 N7414 M74-1 N74-2	 BL50M193-1 BL50M172-2 BL50M136-2 BL50M173-1	 M55-4 M50-5 M52-1 M90-3 M50-2 M76-1
III	5	 M187-1 M68-8 M19814 M74-3 M32-1 M52-2		 M18-1 M91-1 M191-1 M82-2 M82-1 M84-2
	6	 M192-1 M192-3		 M21-1 M23-2 M58-2 M55-1 M88-1 M82-2 M85-2

Fig. 101b. Kayue culture, periodization of the Yellow River region sites: Ahatela, Shangbanzhuwa and Shanpingtai (after Shui T. 2001a, 231 Fig. 24; 236 Fig. 27; 237 Fig. 28; 240 Fig.14).

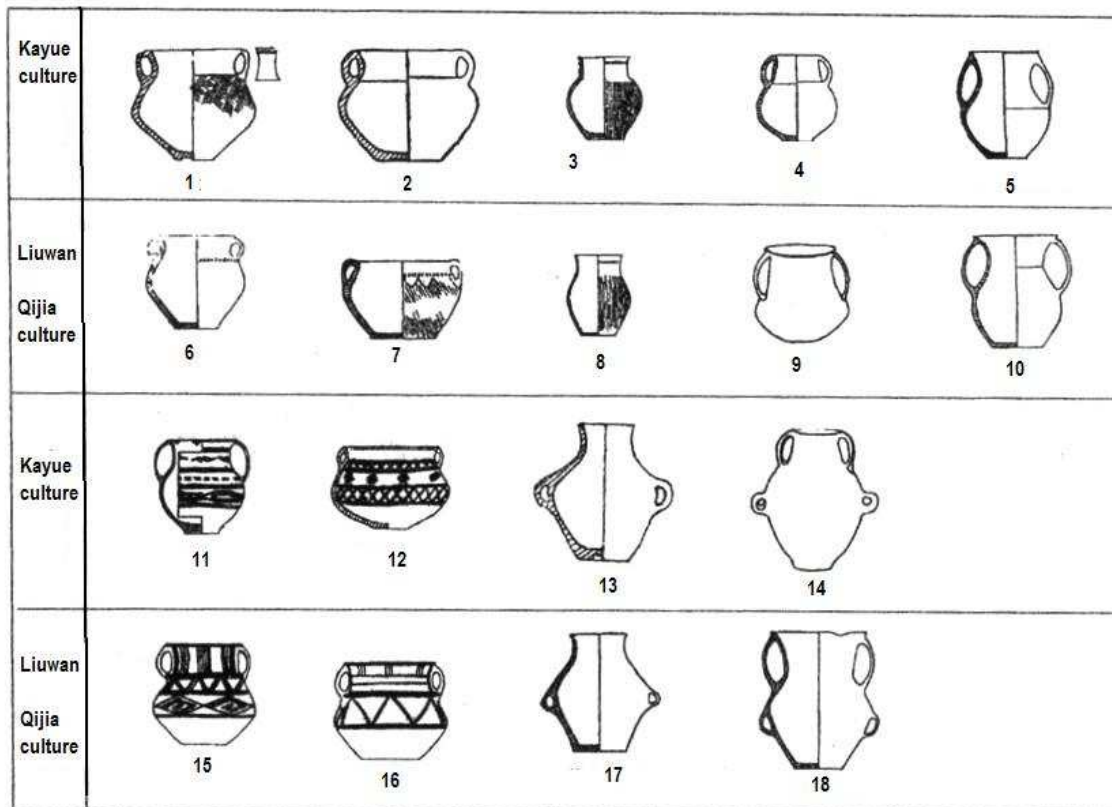

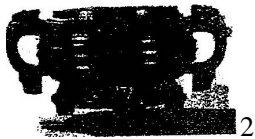
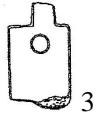
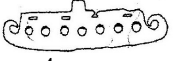
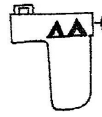
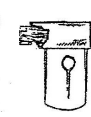

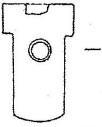
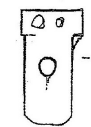
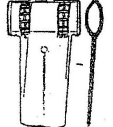


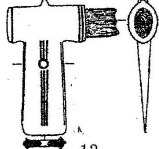
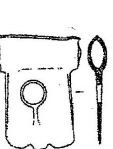
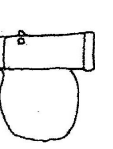
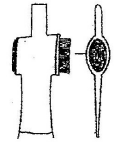
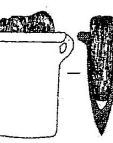


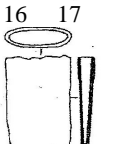
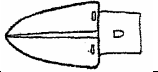
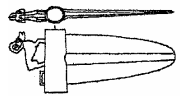
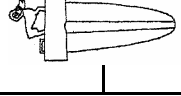
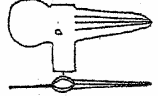
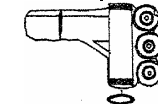
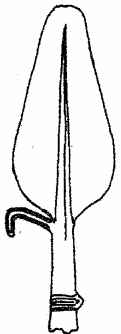
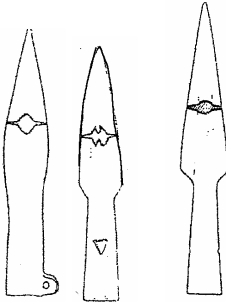

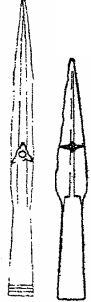
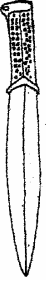


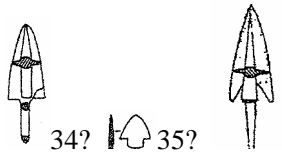
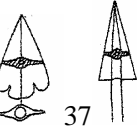


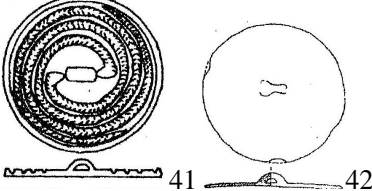
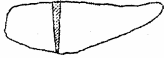
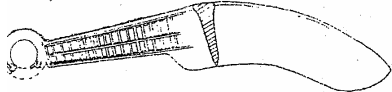
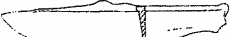




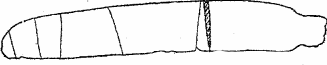


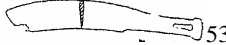


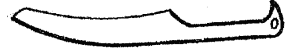


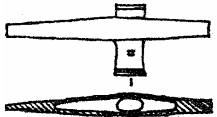

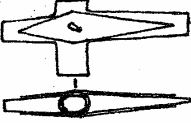
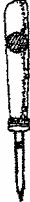

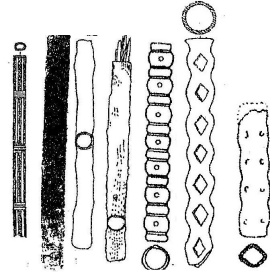
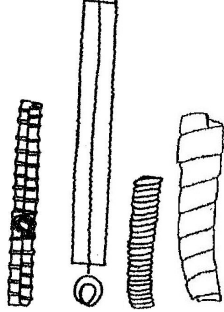
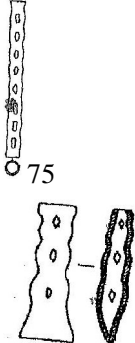
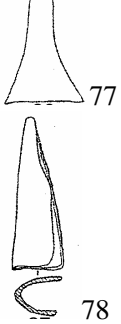
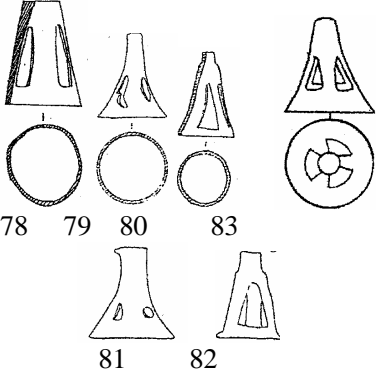
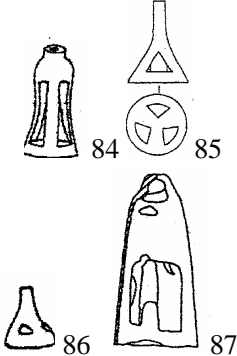
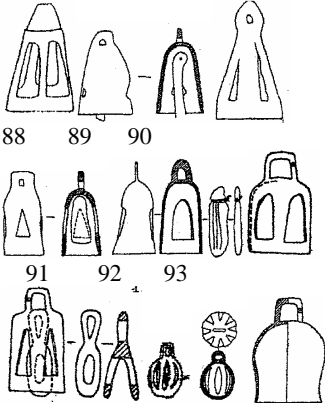
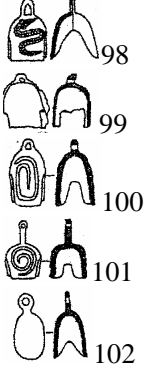
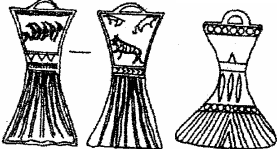



Fig. 101c. Comparing the early Kayue culture with the late Qijia culture, 1 Panjiliang; 2-5 Shangbanzhuwa; 6-10.15-18Liuwan; 11 Suhusa; 12 Ahatela; 13-14 Kayue (adapted from ZWL 2003, 155 Fig. 3.16).

Time Bronze		Shang Dynasty		Western Zhou	Eastern Zhou	
		Early 1600-1251 BC	Late 1251-1046 BC	1046-771 BC	Spring-Autumn period 771-475 BC	Warring States period 475-221BC
Container						
Weapon	axe	 	       	        		
	dagger axe		<p>20</p> <p>21</p>  		<p>22</p> <p>23</p>  	

Weapon	spear	 24		 25? 26 27	 28	 29 30
	sword				 31	 32
	Arrow head	 33	 34? 35? 36	 37 38	 39	 40
Mirror		 41 42				

Tool	Knife	 <p>43</p>	 <p>44</p>  <p>45?</p>  <p>46?</p>  <p>47?</p>	 <p>48</p>  <p>49</p>  <p>50</p>  <p>51</p>  <p>52</p>	 <p>53</p>  <p>54</p>  <p>55</p>  <p>56</p>	 <p>57</p>  <p>58</p>
	Chisel		 <p>59</p>	 <p>60</p>  <p>61</p>		
	Awl				 <p>62</p>  <p>63</p>	

Tube			 <p>64 65 66 67 68 69 70</p>	 <p>71 72 73 74</p>	 <p>75 76</p>
Bell	 <p>77 78</p>	 <p>79 80 81 82 83</p>	 <p>84 85 86 87</p>	 <p>88 89 90 91 92 93 94 95 96 97</p>	 <p>98 99 100 101 102</p>
Plaque		 <p>103-104</p>	 <p>105</p>		

Loop hairpin		<p>106 107 108 109-111</p>	<p>112 113 114 115 116</p>	<p>117 118</p>	
Bulb		<p>119-122 123-126 ? 127?</p>	<p>128-131 132-134, 135 136-138</p>	<p>139 ?140 141 142</p>	
Bead		<p>143-150?</p>	<p>151-153</p>		

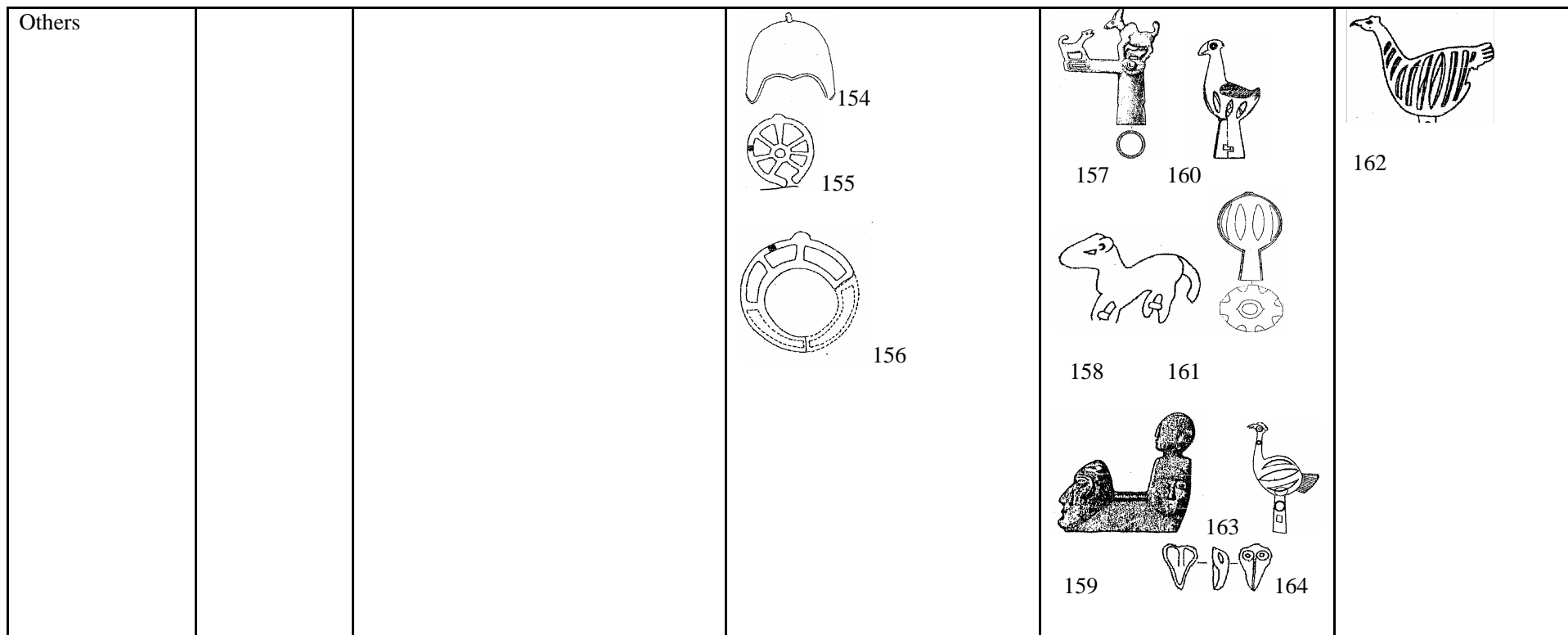


Fig. 101d. Kayue culture, copper and bronze objects, 1 Baojiashai; 2.25-27.29.40.42.47.55.65.70.90.118.126.134.136-138.157 from Dahuazhuangzhuang; 3.8.17.43.50.59.88.119.122.131.151 from Shangbanzhuwa; 4 from Ahatela; 6.9.10.11.14.33.36.44-46.48.49.51.53.54.64.69.77-79.81.82.83.111.117.130.143.149.150 from Panjialiang; 5 from Liangjiao; 7 from Qianying; 15.18.28 from Huangzhong; 13.15.16.19.20.34.35.39.56.63.68.71-73.75.76.80.84.85.89.91.92.96.98.100-110.112-116. 121.123.125.127.133.135.139-142.144-147.150.152.153.155.156.158.163.164 from Shangsunjiashai; 12 from Chuankou; 21 from Xiazhiquan; 22 from Dongcun; 23 from Dong'anishi; 24 from Shenna; 30 from Huabiliang; 31 from Guanting; 32.58 from Zong'an; 41 from Datong; 52.86 from Luanshan; 57.99 from Shanpingtai; 60.87.132 from Dongcun; 61 from Shangzhiquan; 62.67 from Gangcha; 66.74. 93.94.97.124,161 from Huangjiashai; 95 from Wangyufutian; 120.147 from Suhusa; 159.160 from Huangyuan; 162 from Huangzhong.

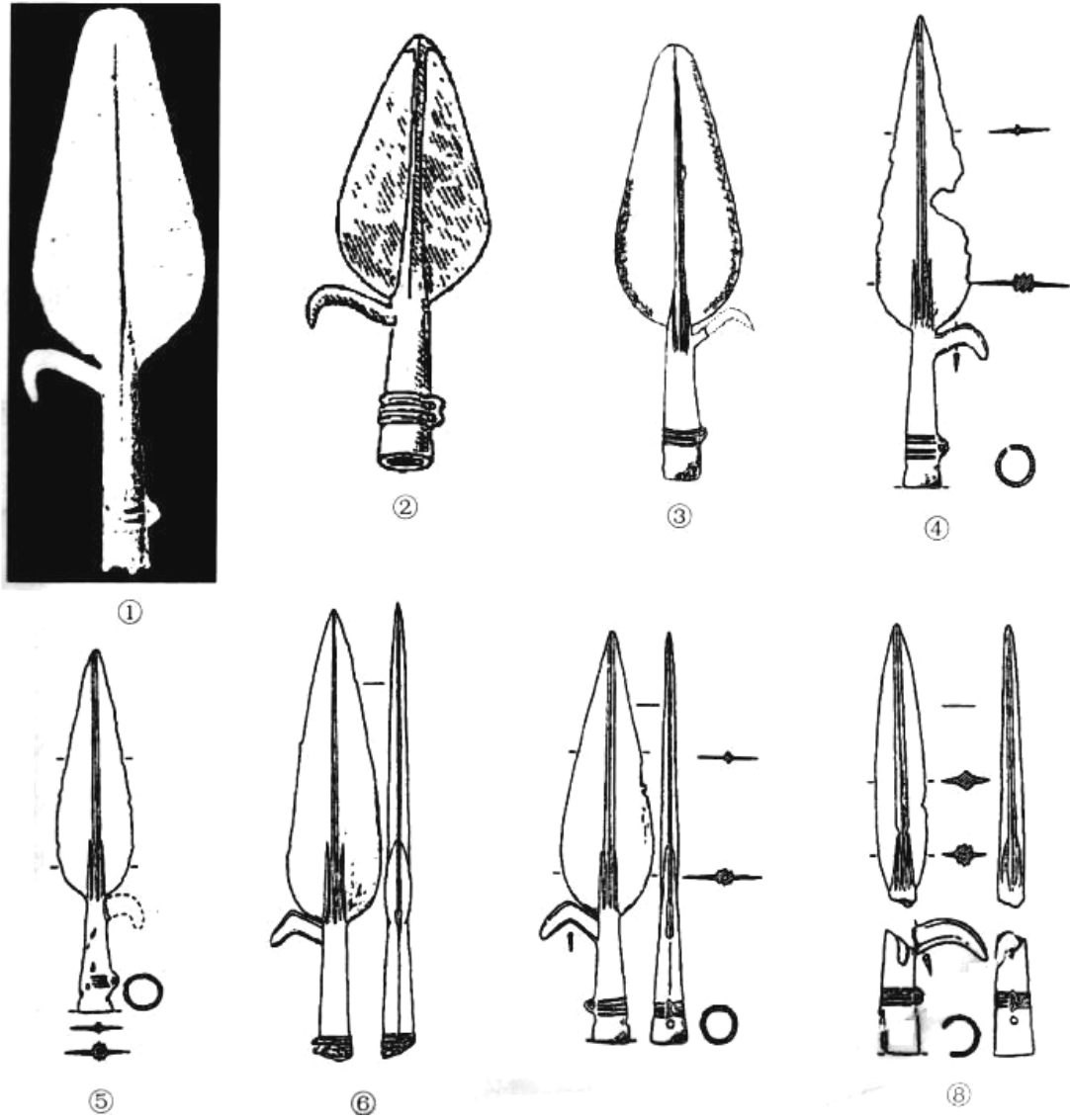


Fig. 102. Bronze spears with tubular handle found in China and south Siberia, 1 Shenna; 2 stored in the Shaanxi Province Museum; 3 stored in the Shanxi Province Museum; 4-8 south Siberian (after Mei J. J. 2001, 17 Fig. 3).

Site	Siwashan	Xujianian	Jiuzhan
I	1		
	2		
	3		
II	4		
	5		
III	6		

Fig. 103a. Siwa culture, periodization of the sites: Siwashan, Xujianian and Jiuzhan(adapted from Shui T. 2001a, 223 Fig. 19; 224 Fig. 20; 225 Fig. 21; 227 Table 12).

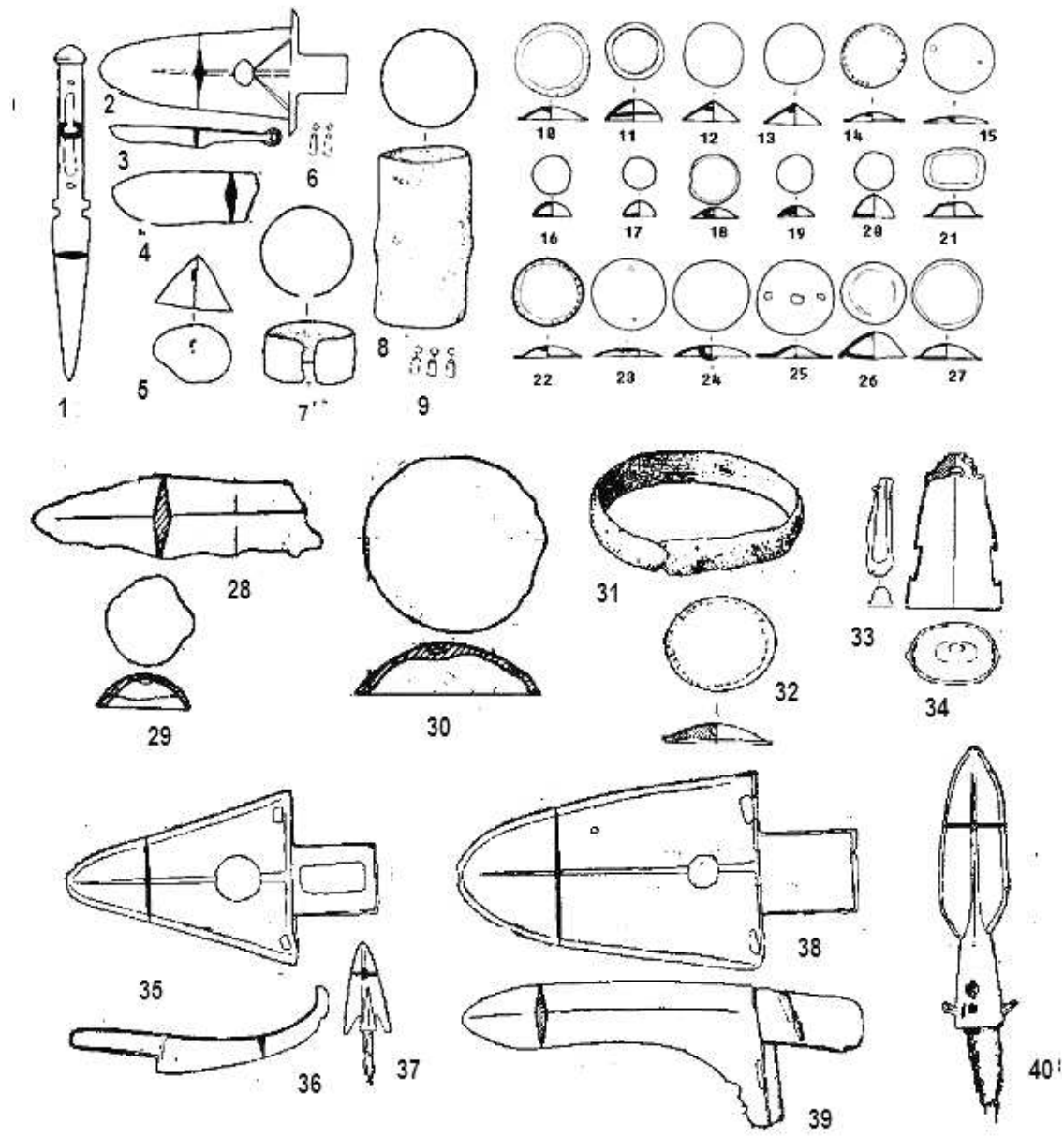


Fig. 103b. Siwa culture, copper and bronze artifacts, 1-27 Jiuzhan; 28-30 Lanqiao; 31 Siwashan; 32-40 Xujianian (after Fig. 055a; Fig. 051b; Fig. 052; Fig. 054).

Site		Donghuishan	Huoshagou
Period	Stratum		
I	1		
	2		
II	3		
	4		
III	5		
	6		
	7		

Site		Ganguya	Shaguoliang, Sibatan, Yingwoshu
Period	Stratum		
I	1		
	2		
II	3		Shaguoliang
	4		Sibatan
III	5		
	6		Yingwoshu
	7		

Fig. 104a. Siba culture, periodization of the sites: Donghuishan and Huoshagou (adapted from Shui T. 2001a, 248 Fig. 34; 245 Fig. 32; 247 Fig. 33; 249 Fig. 35; 250 Table 15).

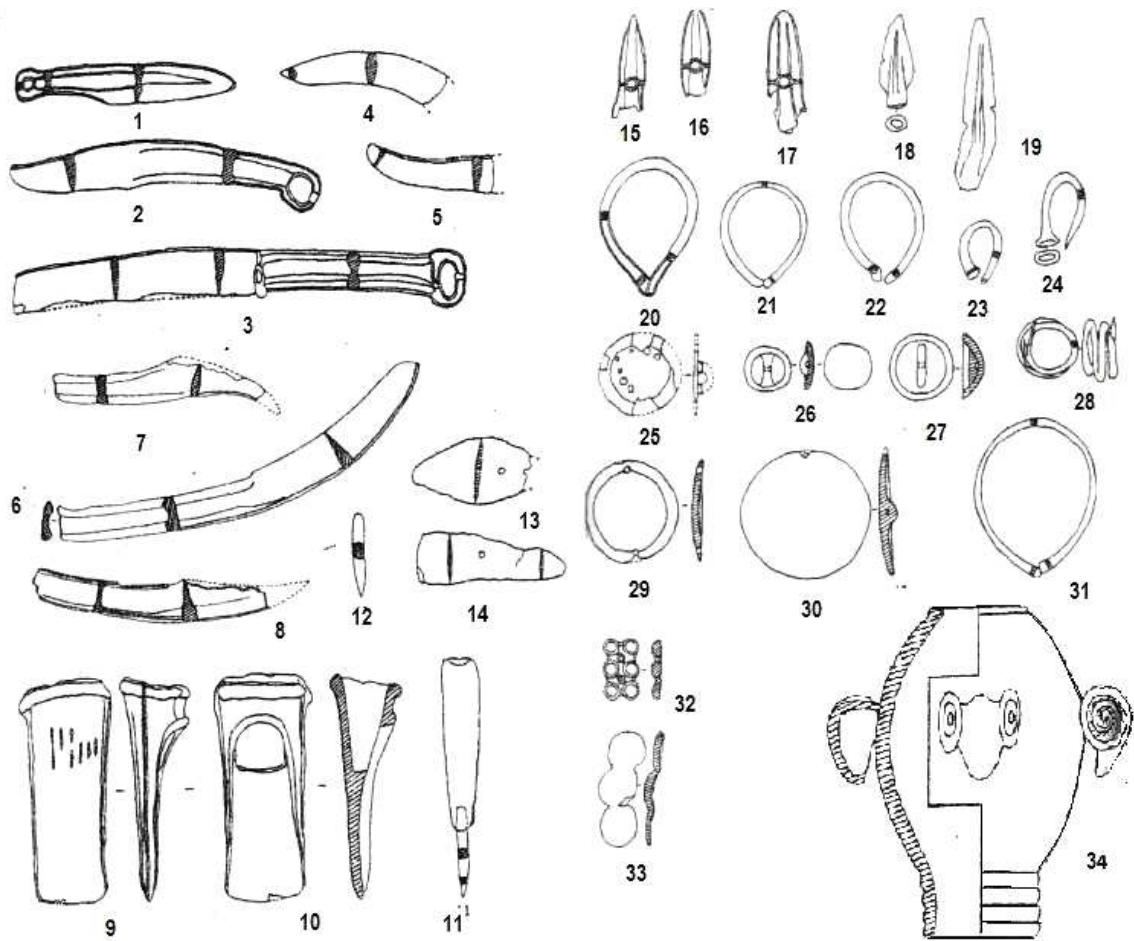


Fig. 104b. Siba culture, copper and bronze objects (after Li/Shui 2000, 37 Fig. 1, 1-14; 38 Fig. 2, 1-4.6-9.13.12.14.17.15.16.18.19.10.11; 39 Fig. 3).

	Shajing	Hamadun	Sanjiaocheng
I			
2			
3			
4			
II			

Fig. 105a. Shajing culture, periodization of the sites: Shajing, Hamadun and Sanjiaocheng (adapted from Shui T. 2001a, 254 Fig. 38; 255 Fig. 39; 256 Fig. 40; 257 Table 16).

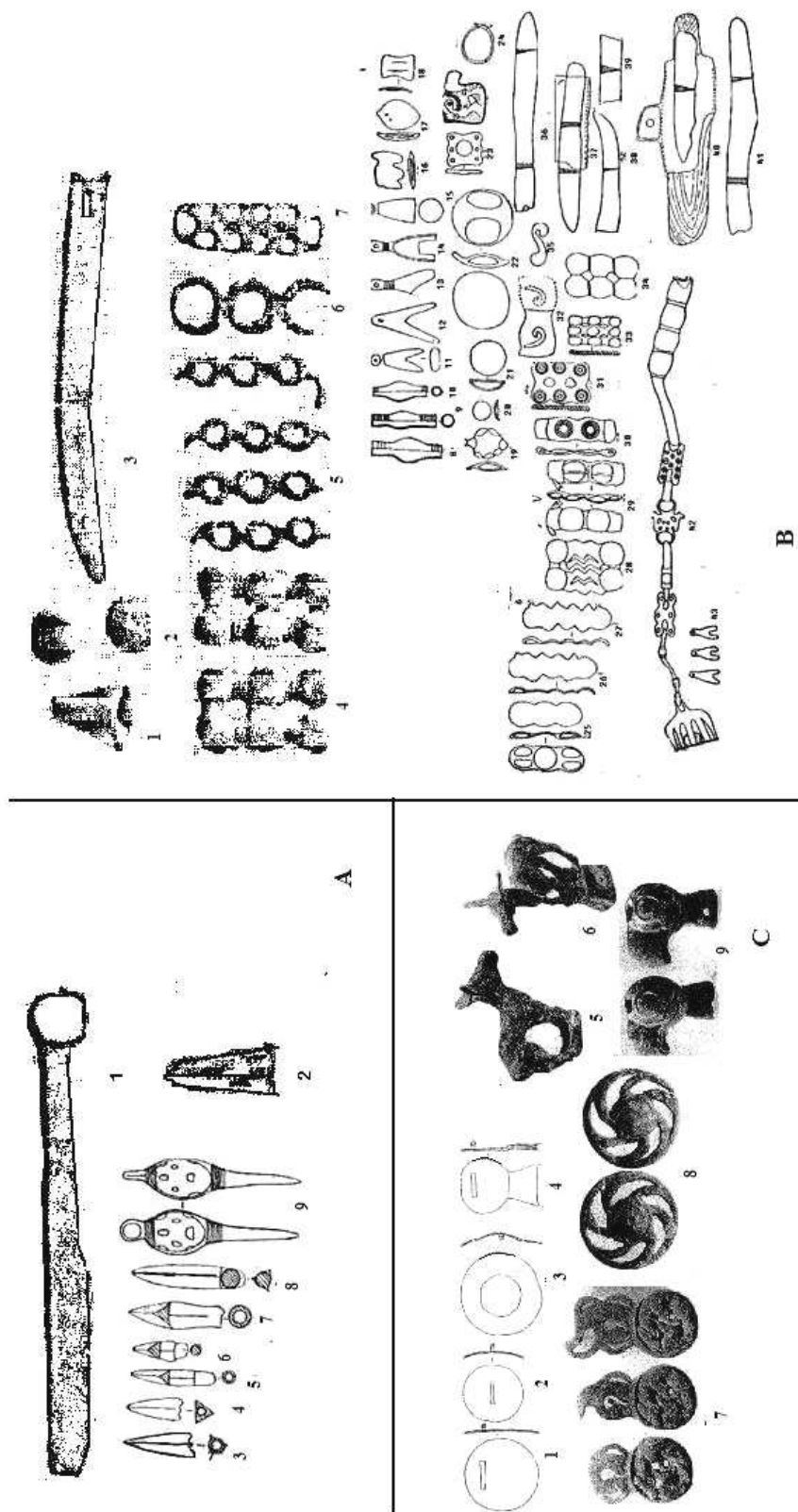


Fig. 105c. Shajing culture, metal objects: A Sanjiaocheng; B Hamadun; C Yushugou (A after Fig. 046a, 1,2; Fig. 046b, 1-7; B after Fig. 046a, 3-8; Fig. 046b, 8-41; C after Fig. 066).

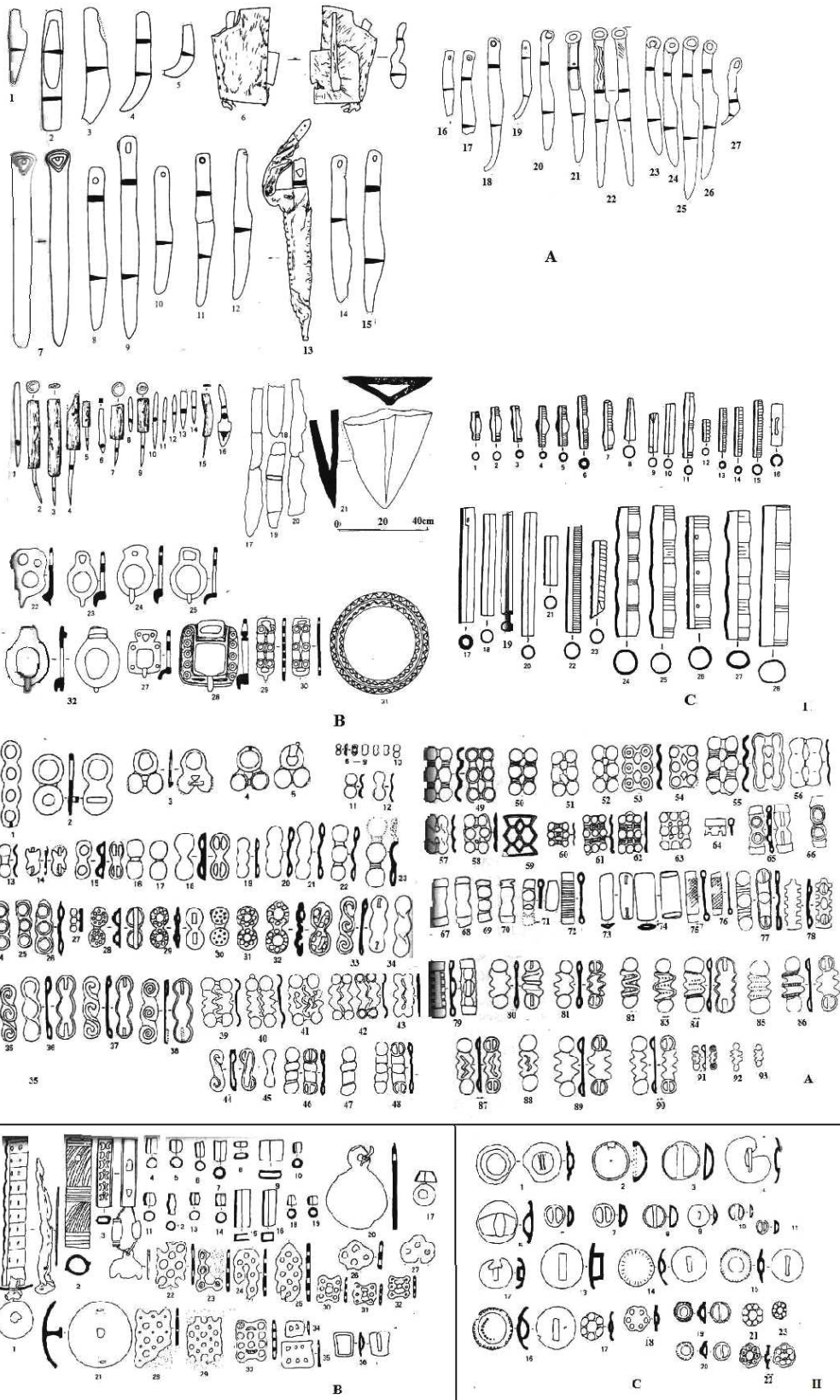


Fig. 105d. Shajing culture, metal objects, Xigang (after Fig. 065f; Fig. 065h).

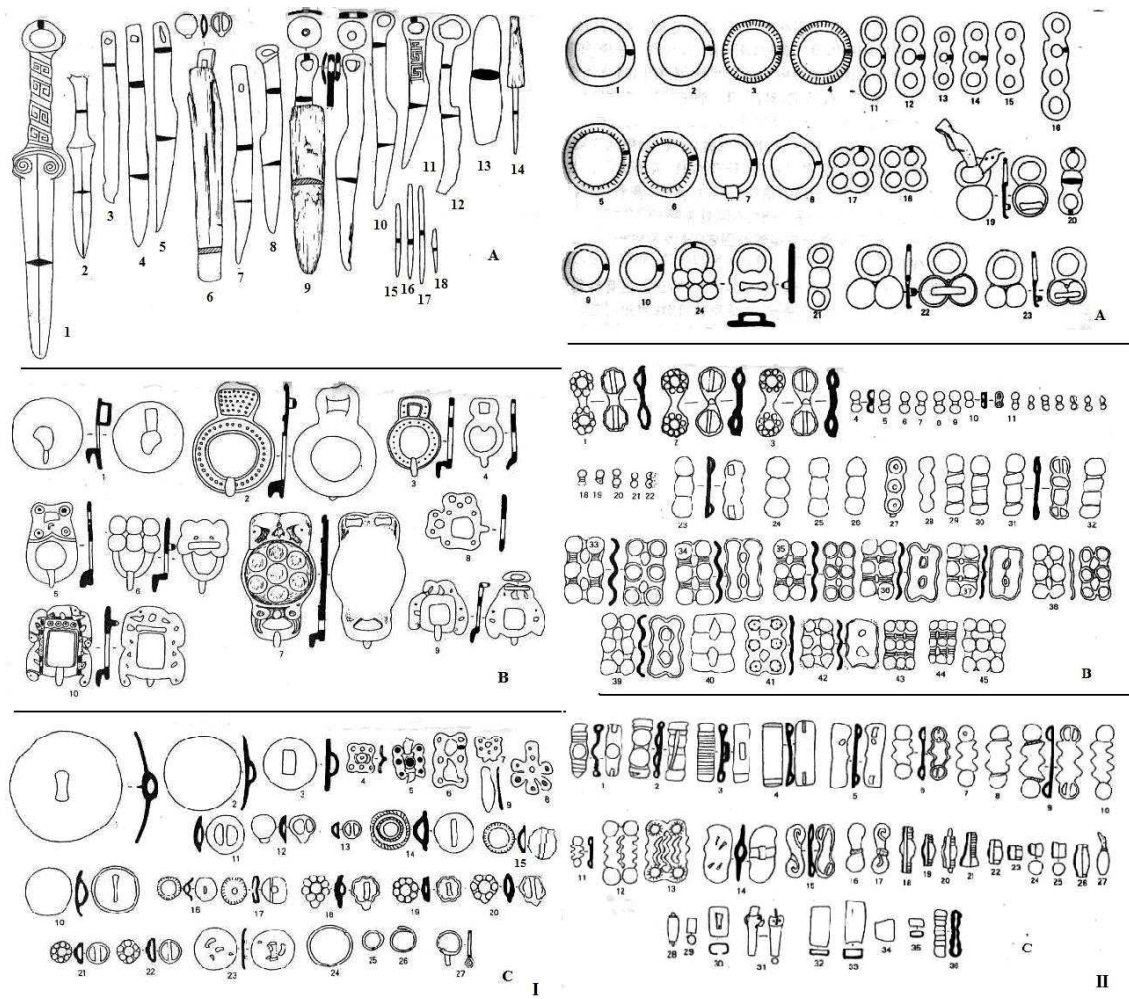


Fig. 105e. Shajing culture, metal objects, Chaiwangang (after Fig. 098d; Fig. 098e).

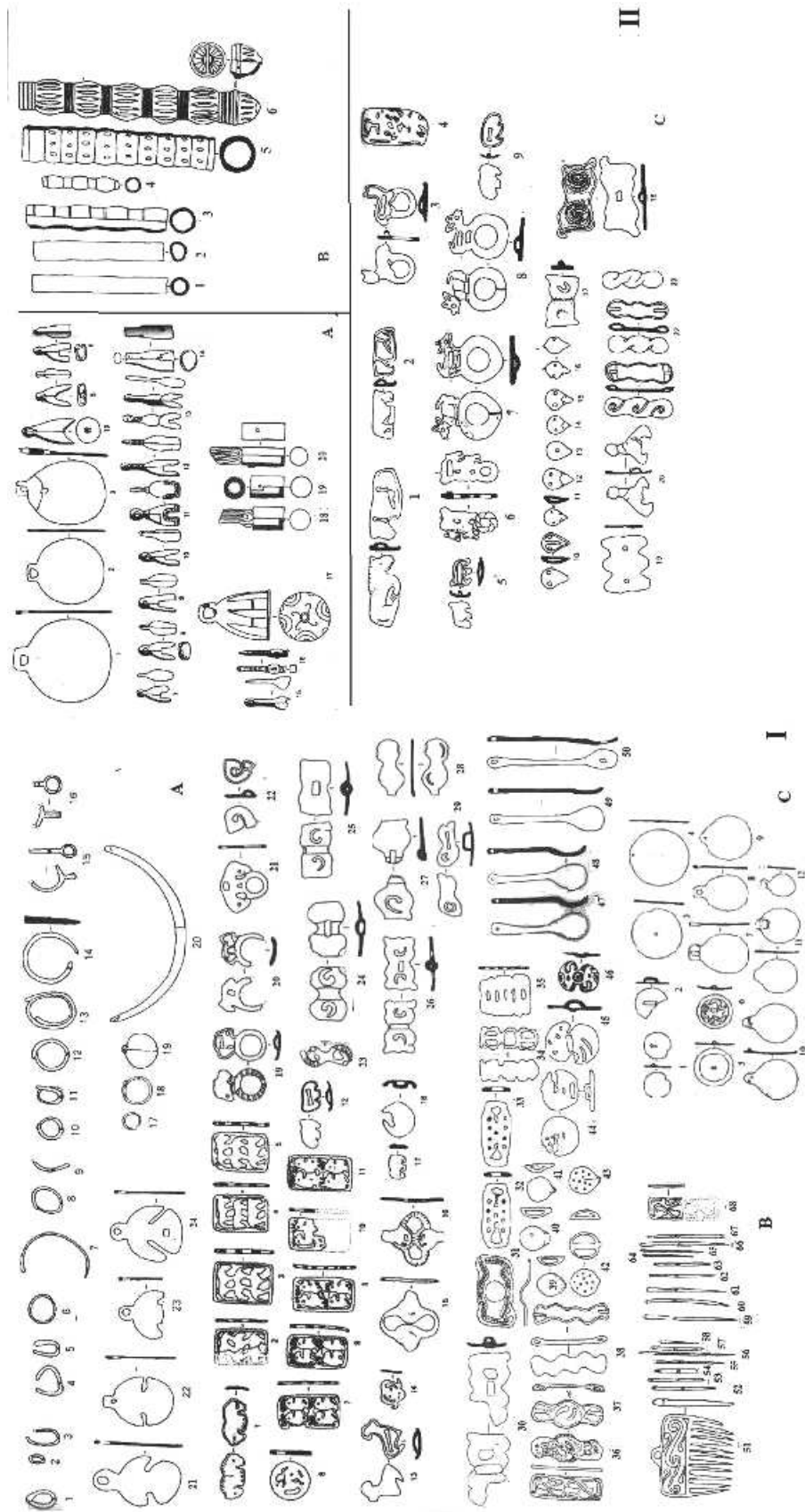


Fig. 105f. Shajing culture, metal objects, I Xigang; II Chaiwangang (after Fig. 065h; Fig. 098f).

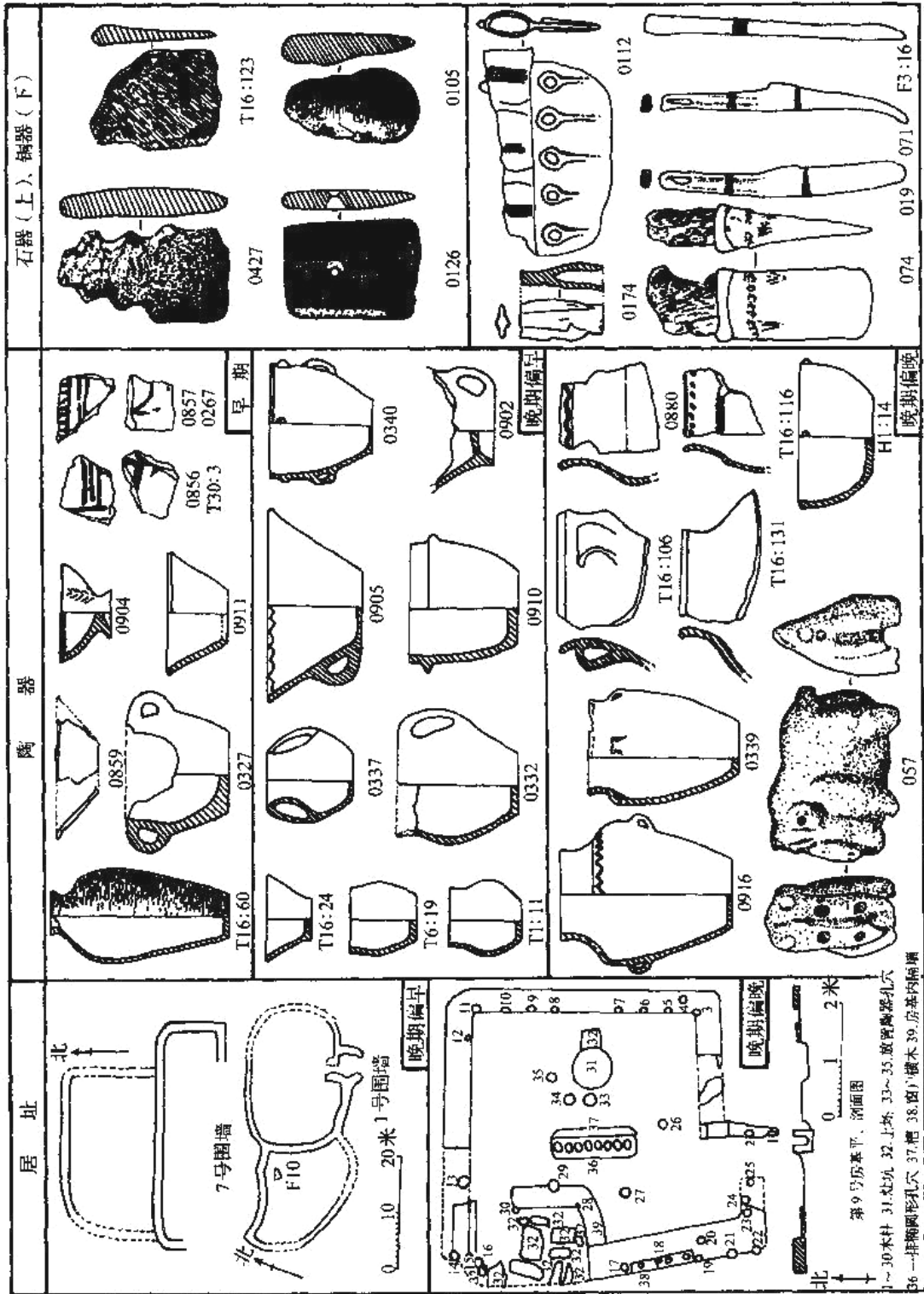




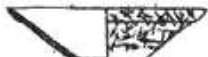



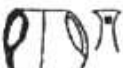







Fig. 106a. Nuomuhong culture, periodization of the Dalitaliha site (after Shui T. 2001a, 271 Fig. 48).

Nuo Mu Hong	 C:0859	 C:0911	 C:0899	 C:077
Qi Jia	 LM864: 5	 LM1128: 2	 LM834: 1	 LM709: 3

A

Nuo Mu Hong	 C:0337	 C:0332	 0327
Ka Yue	 G 89GC M14: 3	 D M112: 4	 SM40: 1

B

Fig. 106b. Comparing the Nuomuhong culture, Qijia culture and Kayue culture : C, collected; L, Liuwan site; G, Gangcha county; D Dahuazhongzhuang; S Shanpingtai site (adapted from ZWL 2003, 156 Fig. 3.17.1; Fig. 3.17.2).

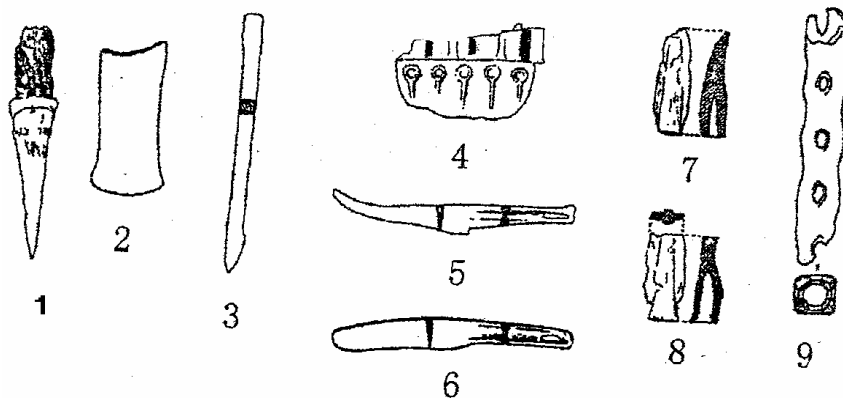


Fig. 106c. Nuomuhong culture, copper and bronze artifacts: 1-8 Dalitaliha; 9 Buha; (after ZWL 2003, 158 Fig. 4.3).















Stage	
IV	 S M63  S M63
III	 A M158: 1  A M1043: 1  A M158: 3  SH M1043: 2
II	 G H1: 1  A M33: 1  A M33: 2  G H1: 2  G H1: 2
I	 SH  Z  Z

Fig. 107a. Tangwang-style-pottery, periodization of the sites at Suhusa, Ahatela, Gongbeitai, Shangsunjiashai, and Zhangkashan: S - Suhusa; A - Ahatela; G - Gongbeitai; SH - Shangsunjiashai; Z - Zhangkashan (adapted from ZWL 2003, 157 Fig. 3.18).









Tang Wang	 Shangsunjiashai  Naniwan  Zhangkashan  Gongbeitai H1: 2
Others	 Huoshaogou M45: 2  Donghuishan M181: 1  Subashen M6: 21  Huangjiashai 019

Fig. 107b. Tangwang-style-pottery, comparing potteries from other cultures (adapted from ZWL 2003, 157 Fig. 3.19).

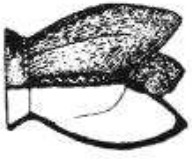
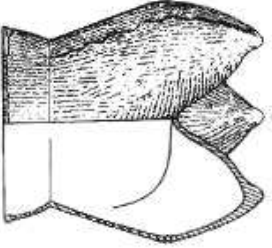
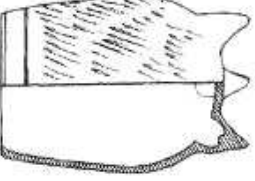
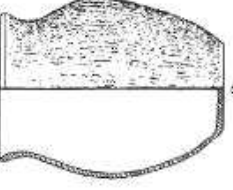
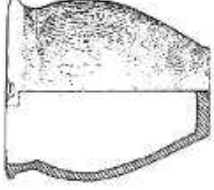
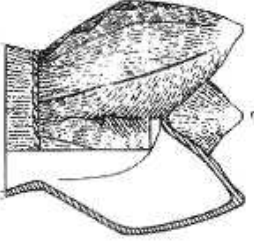
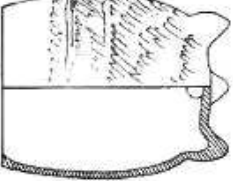
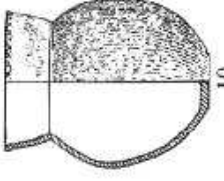
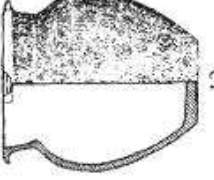
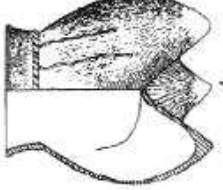
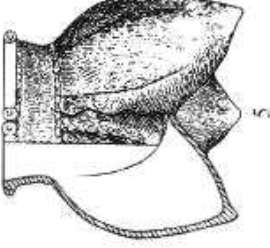
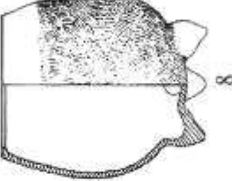
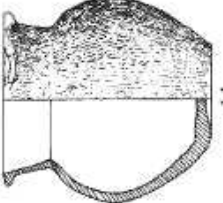
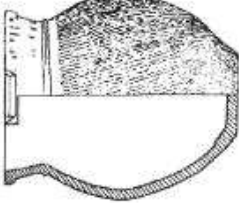
T P	Snake motif Li-tripod	Urn with three feet	Pot with buttons
Early	 1  2	 6	 9  12
Middle	 3	 7	 10  13
Late	 4  5	 8	 11  14

Fig. 108a. Zhukaigou culture, periodization of the potteries, 1 Baoniyaozi; 2-14 Zhukaigou (adapted from Beifangcaoyuan 2007, 74 Fig. 33).

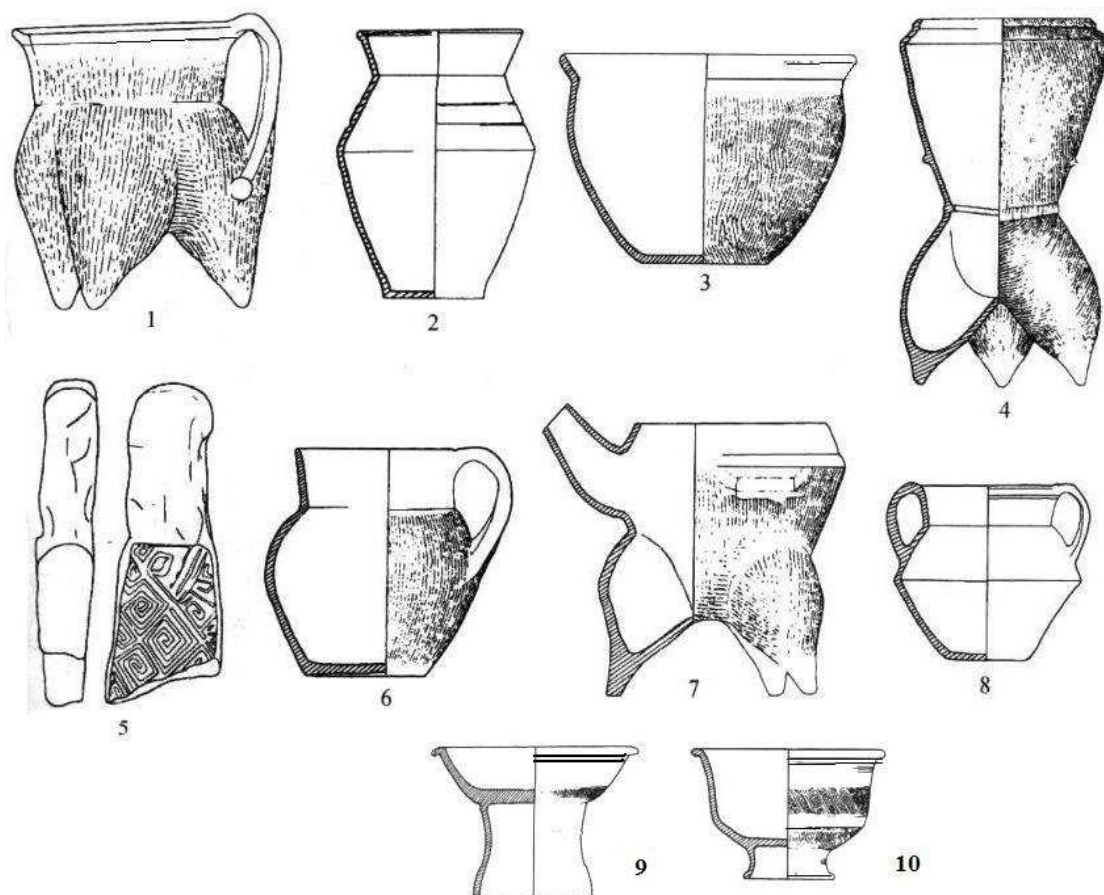


Fig. 108b. Zhukaigou site, potteries (after Beifangcaoyuan 2007, 75 Fig. 34, 1-8; 82 Fig. 39, 5.6).

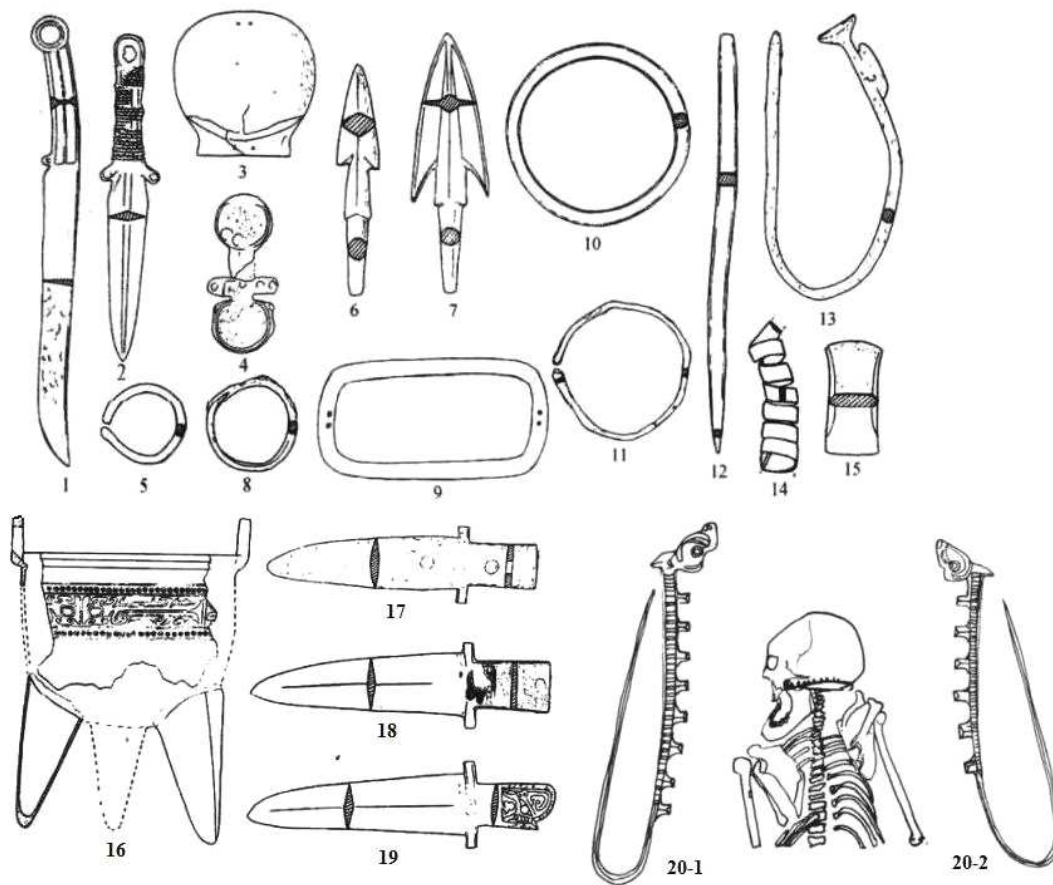
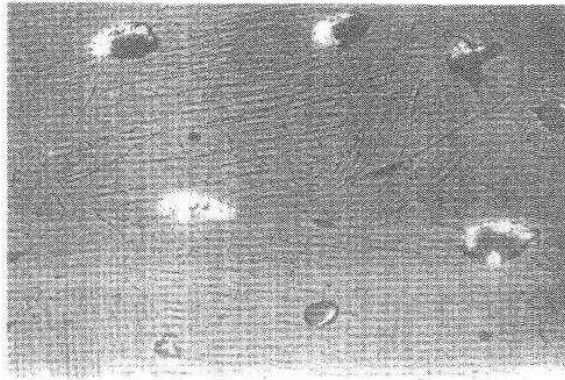
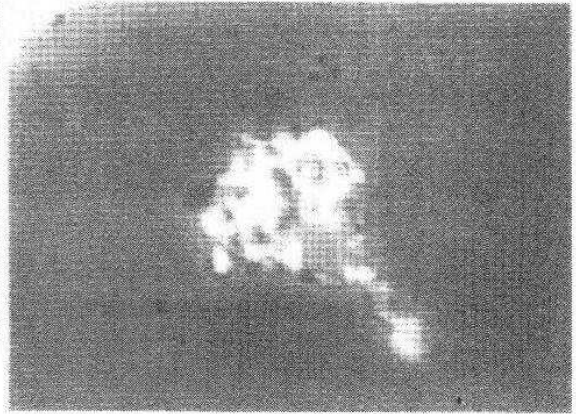


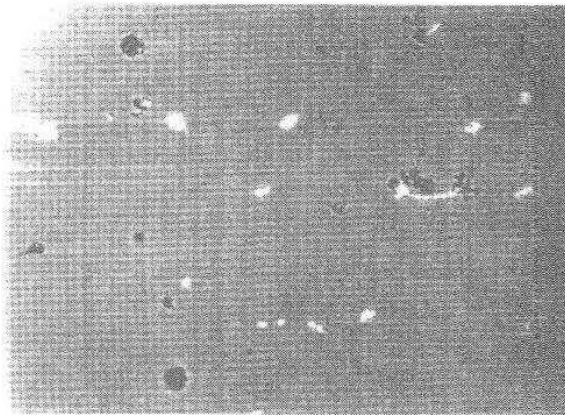
Fig. 108c. Zhukaigou culture, metal objects: 1-19 bronze, from Zhukaigou; 20 gold, from Tebuxiwula (after Beifangcaoyuan 2007, 76 Fig. 35, 1-15; 82 Fig. 39, 1-4; 78 Fig. 36).



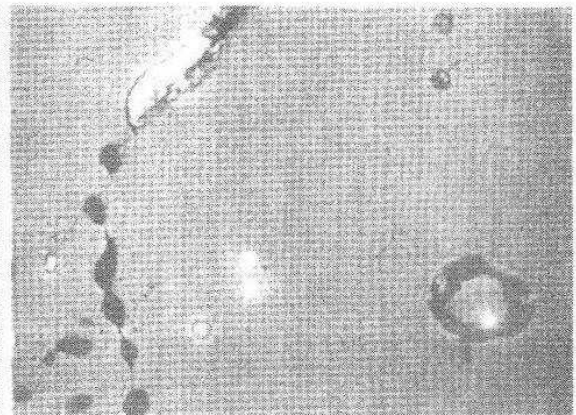
1. T238③:1 needle (2692) back reflected electron image
× 1500



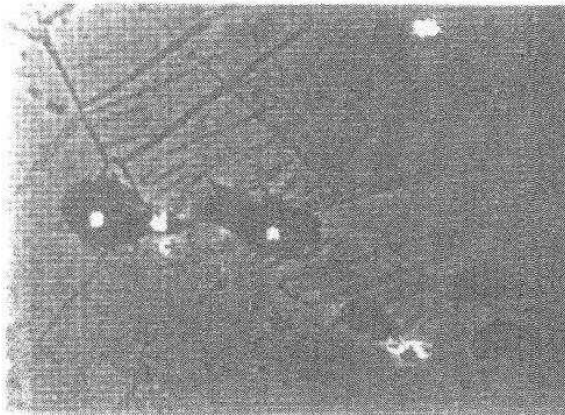
2. H1044: 1 awl (2673) back reflected electron image
× 6000



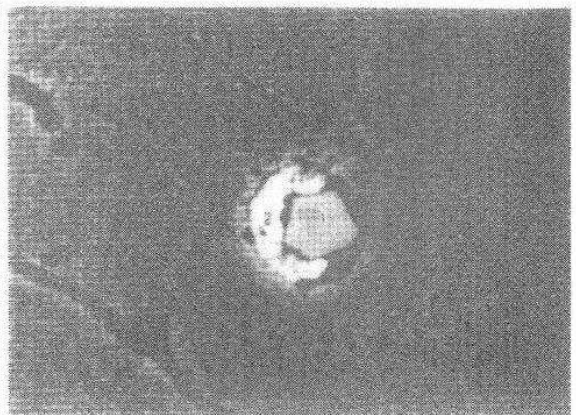
3. H1044:1 awl (2673) back reflected electron image
× 1000



4. M4007: 2 armband (2692) back reflected electron image
× 1500

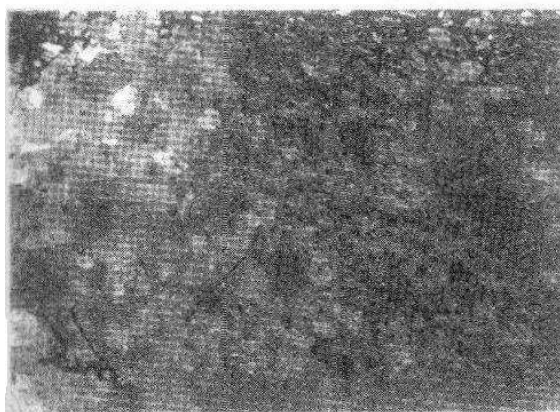


5. earring (2700) back reflected electron image × 3600

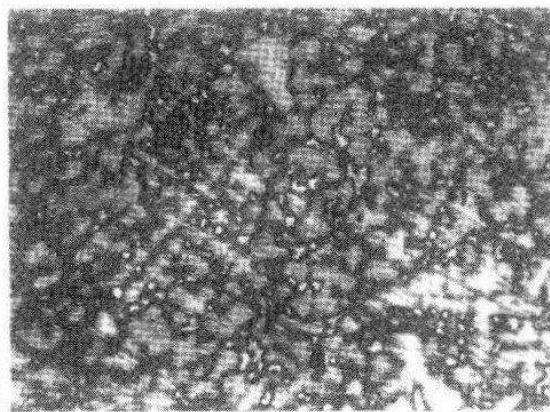


6 earring (2700) back reflected electron image × 8000

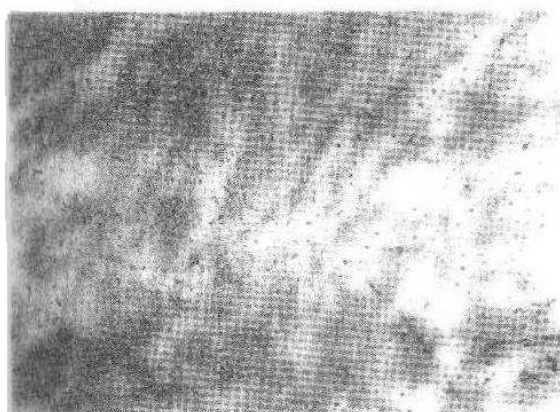
Fig. 108d. Zhukaigou site, back reflected electron image of the bronze artifacts (adapted from Li/Han 2002, 255 Plate 1).



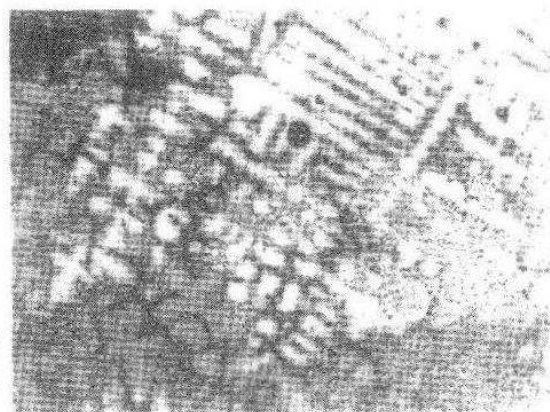
1. T238③:1 needle (2692) metallurgical structure × 100



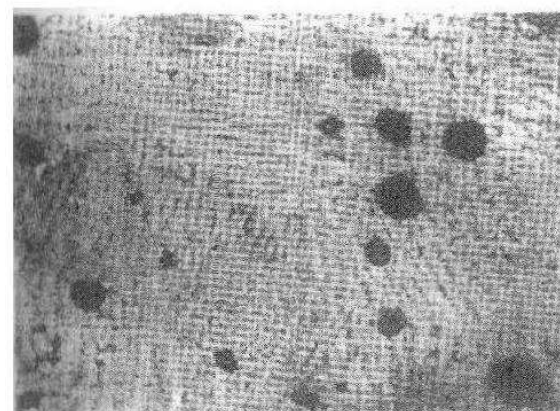
2. T230③:1 chisel (2696) metallurgical structure × 100



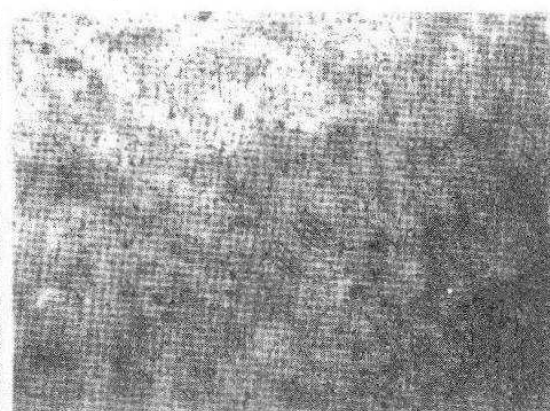
3. H1044:1 awl (2673) metallurgical structure × 100



4. M4007:2 armlet (2697) metallurgical structure × 100

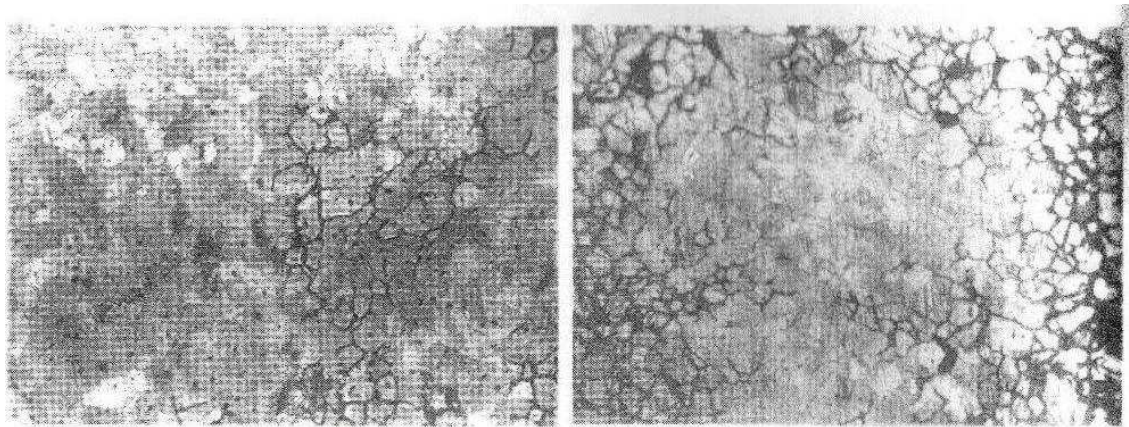


5. M4040:1 arrow (2693) metallurgical structure × 100



6. M4060:6 ring (2694) metallurgical structure × 100

Fig. 108e. Zhukaigou site, metallurgical structure of the bronze artifacts (adapted from Li/Han 2002, 256 Plate 2).



1. earring (2699—1) metallurgical structure × 100

2. earring (2699—2) metallurgical structure × 100



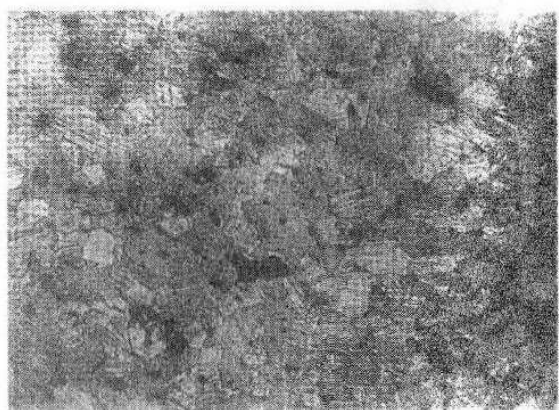
3. earring (2699—3) metallurgical structure × 100



4. earring (2700) metallurgical structure × 100

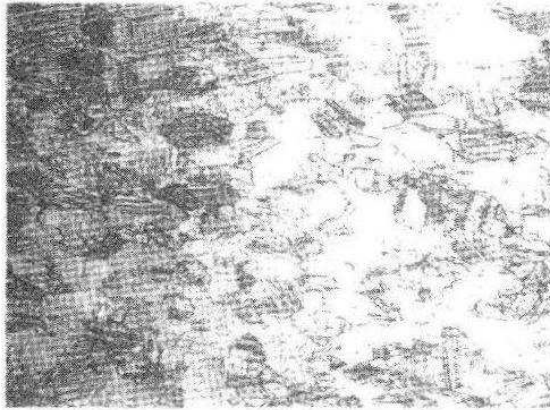


5. earring (2701) metallurgical structure × 100

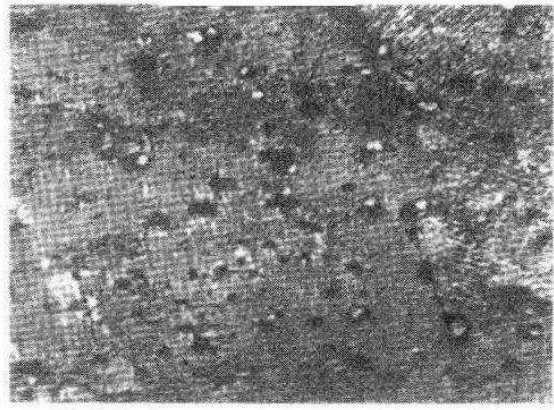


6. M1040: 2 sword (2647) metallurgical structure × 100

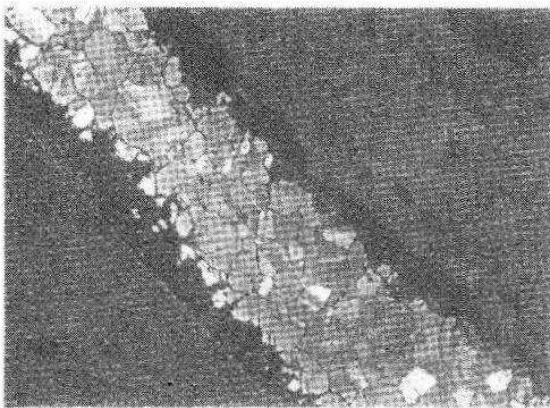
Fig. 108f. Zhukaigou site, metallurgical structure of the bronze artifacts (adapted from Li/Han 2002, 257 Plate 3).



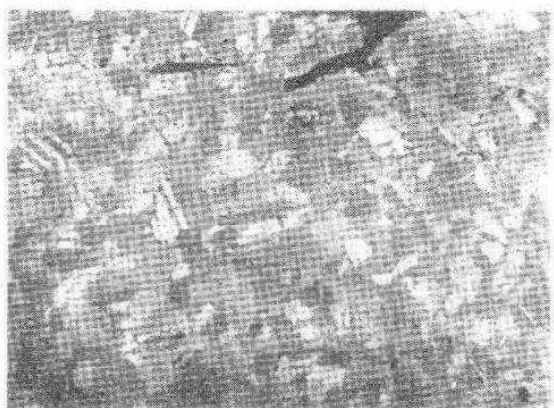
1. M1040:3 knife (2646) metallurgical structure $\times 200$



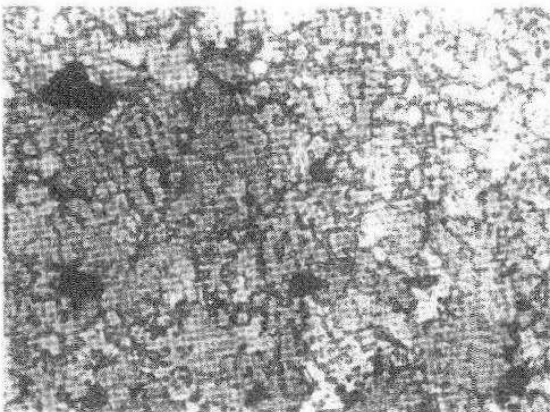
2. M1040:1 battle dagger (2645) metallurgical structure $\times 200$



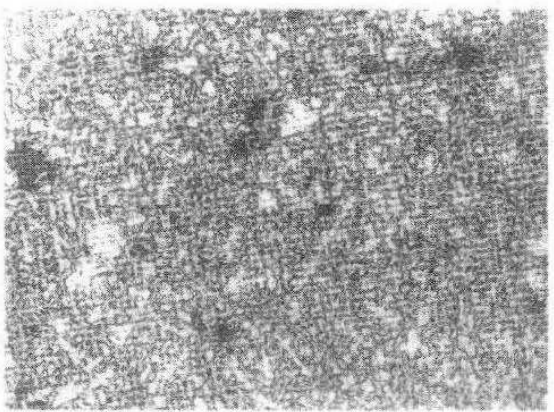
3. M1070 loop (2655) metallurgical structure $\times 100$



4. M2012:2 earring (2689) metallurgical structure $\times 100$

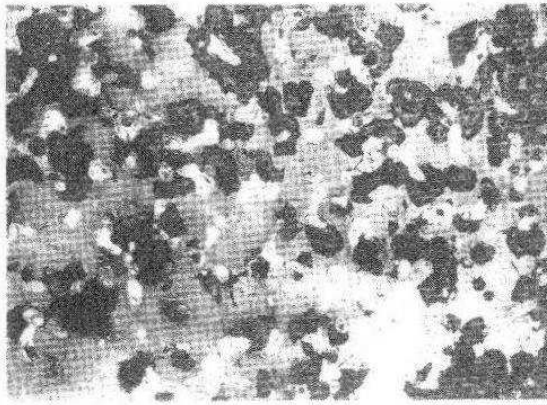


5. H5003:7 arrow (2687) metallurgical structure $\times 100$

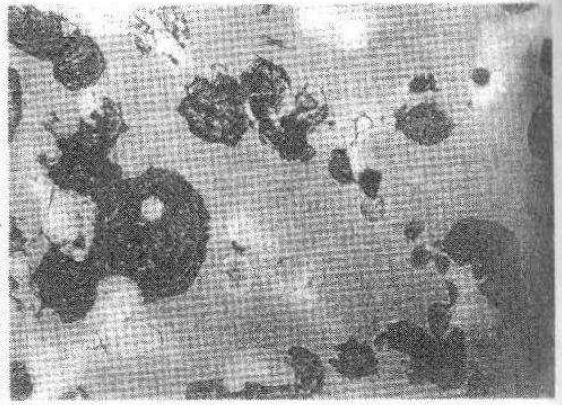


6. H5003:11 arrow (2684) metallurgical structure $\times 100$

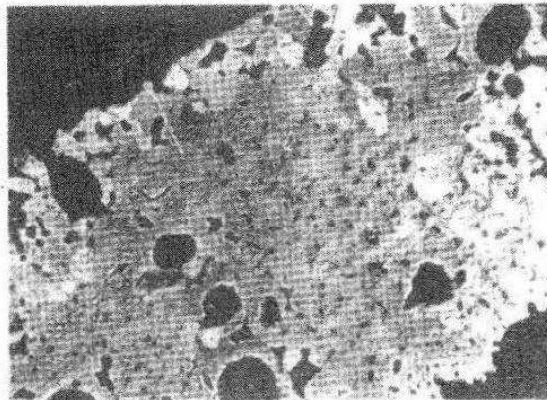
Fig. 108g. Zhukaigou site, metallurgical structure of the bronzes (adapted from Li/Han 2002, 258 Plate 4).



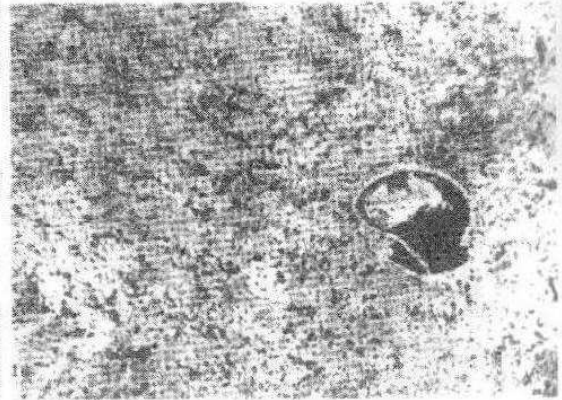
1. H5028: 3 battle dagger (2686) metallurgical structure $\times 100$



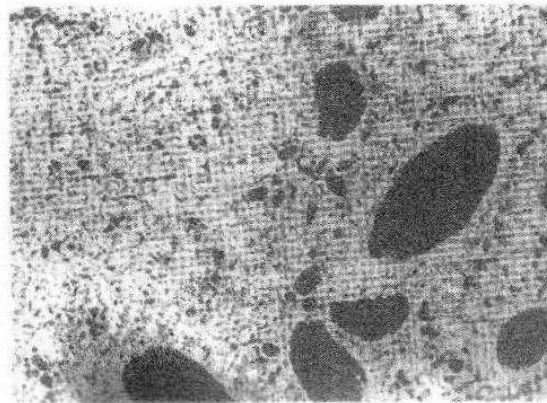
2. H5028: 3 battle dagger (2686) back reflected electron image $\times 300$



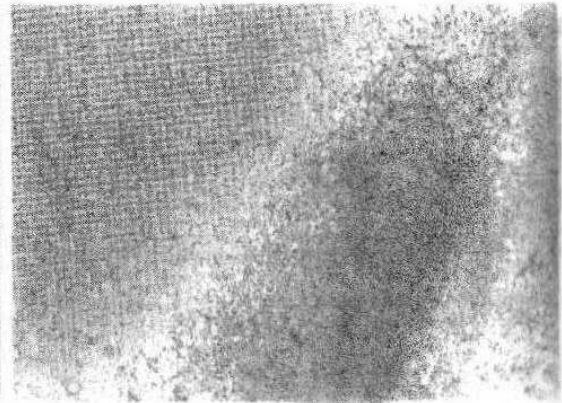
3. H5028: 4 Ding (2671) metallurgical structure $\times 100$



4. H5028: 4 arrow (2674) metallurgical structure $\times 100$



5. F5001:3 arrow (2685-3) metallurgical structure $\times 100$



6. T1242: 1 earring (2688) metallurgical structure $\times 100$

Fig. 108h. Zhukaigou site, metallurgical structure of the bronzes (adapted from Li/Han 2002, 259 Plate 5).

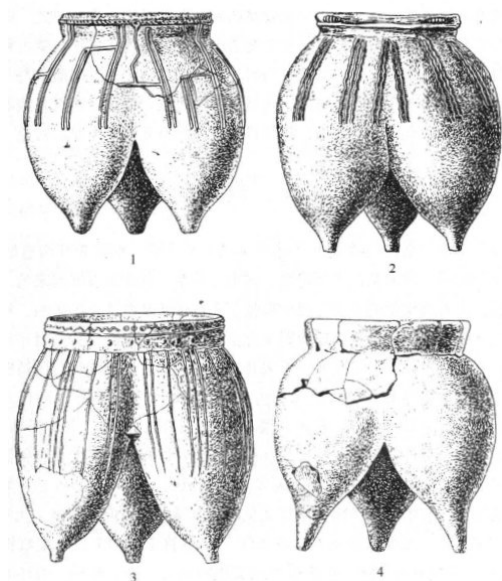


Fig. 108i. Trans-Baikal area, snake-motif potteries (after Beifangcaoyuan 2007, 85 Fig. 42).

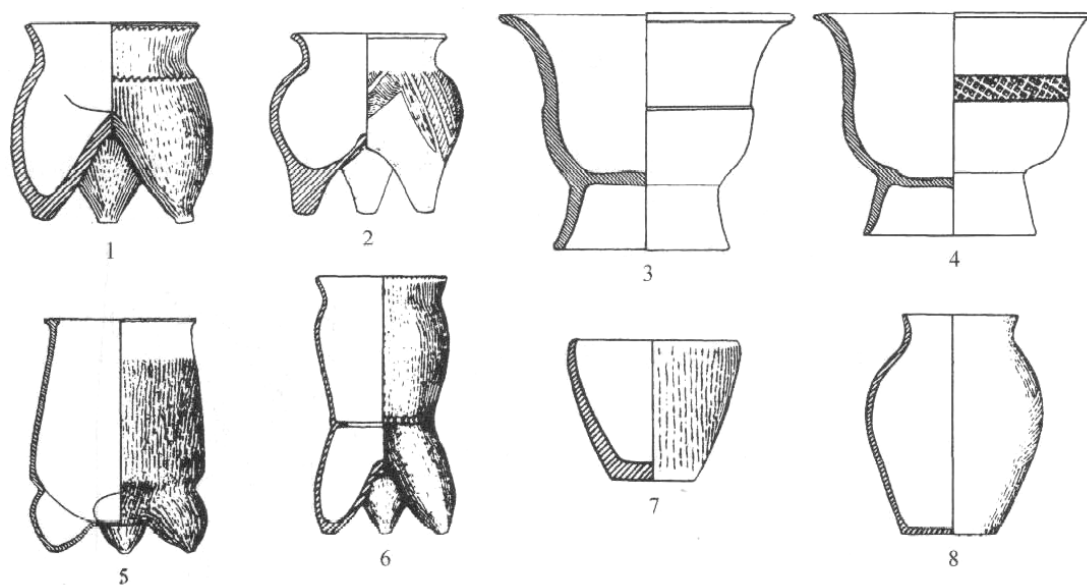


Fig. 109a. Lijiaya culture, potteries, 1-2.6-8 from Lijiaya; 3-5 from Xuejiaqu (after Beifangcaoyuan 2007, 150 Fig. 67).

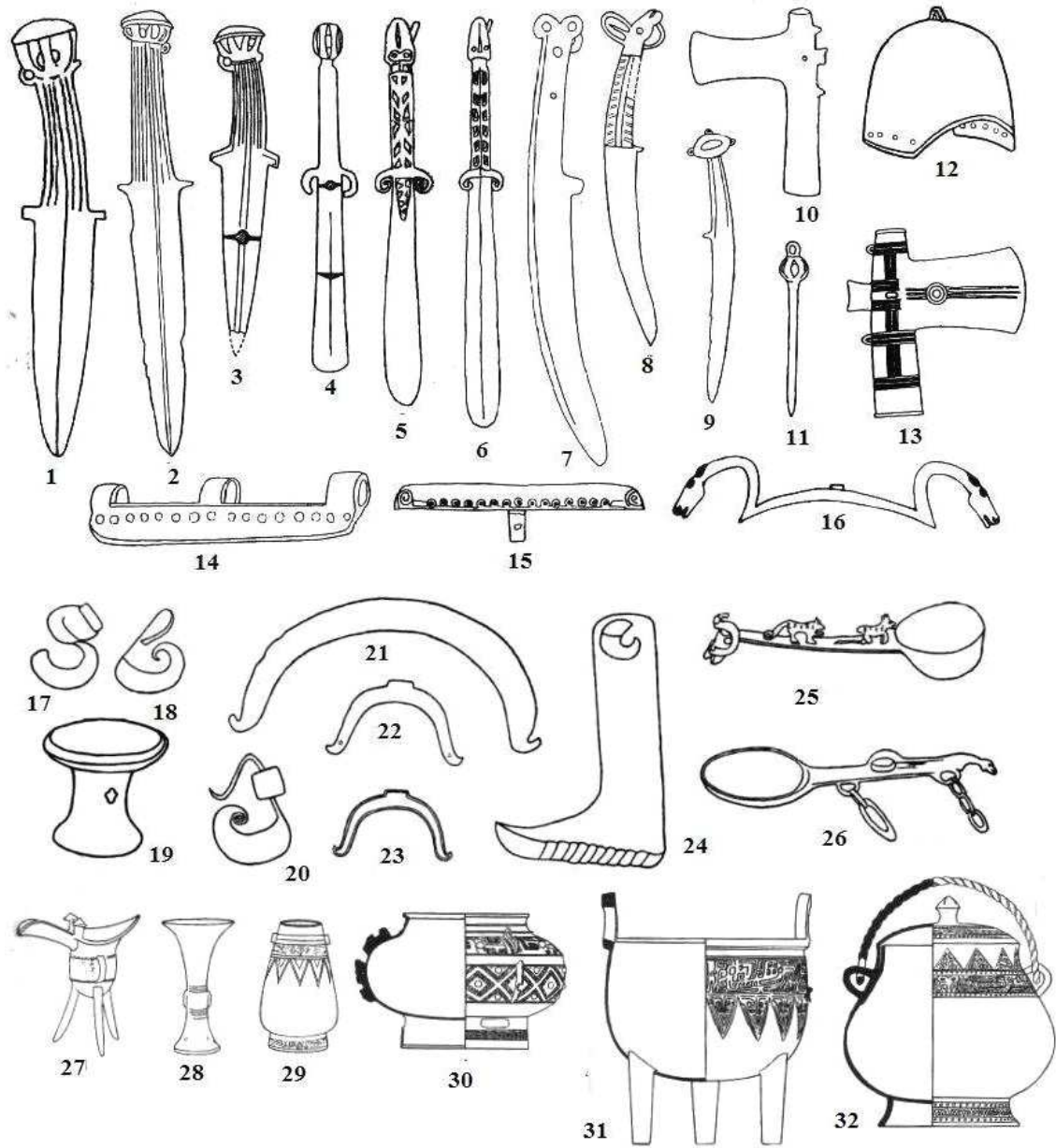


Fig. 109b. Lijiaya culture, metal objects, 1.10.12.26 Caojiayuan; 2.7.24. Gaohong; 3 Qutou in Yanchuan, 4 Qinjian; 5.22 Zhujiayu; 6.9.14.23 Houlanjiagou; 8.27-29 Yantou; 13 Shaodao in Yanchuan; 15.Nanhe in Shilou; 16 Heidouzui in Chunhua; 17.18.Taohuazhuang; 20 Xiaxinjiao; 19.21.30-32 Linzheyu; 22 Zhujiayu; 25 Xiejiagou (after Beifangcaoyuan 2007, 152 Fig. 68, 1-16; 153 Fig. 69, 1-10; 157 Fig. 72, 1-6).

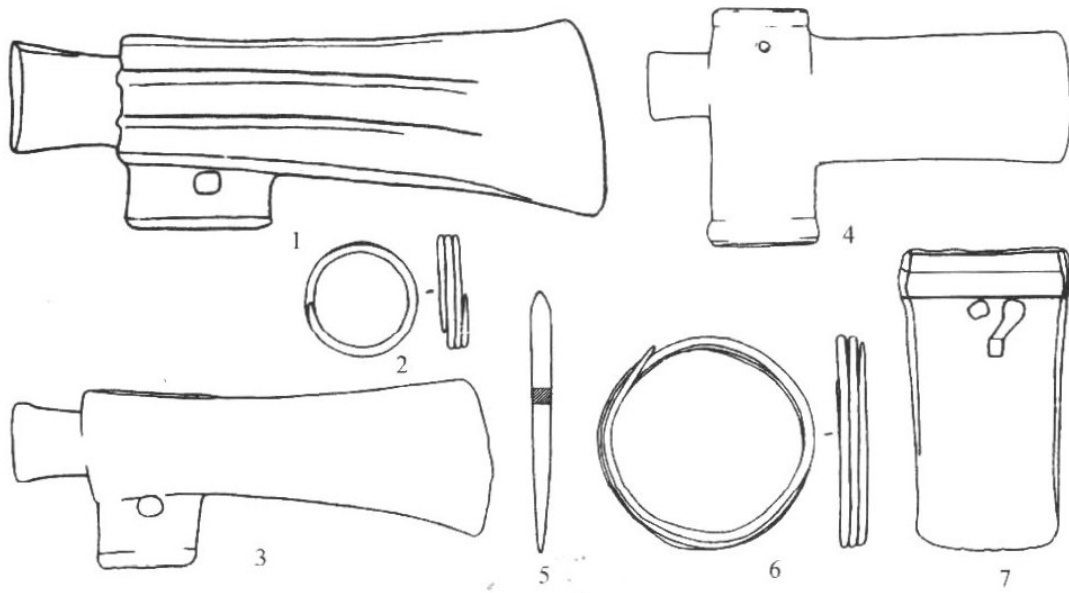


Fig. 110. Xicha culture, bronze objects, 1.2.5.6 Xicha; 3.4 Laoniawan; 7 Maiwenyan (after Beifangcaoyuan 2007, 87 Fig. 43).

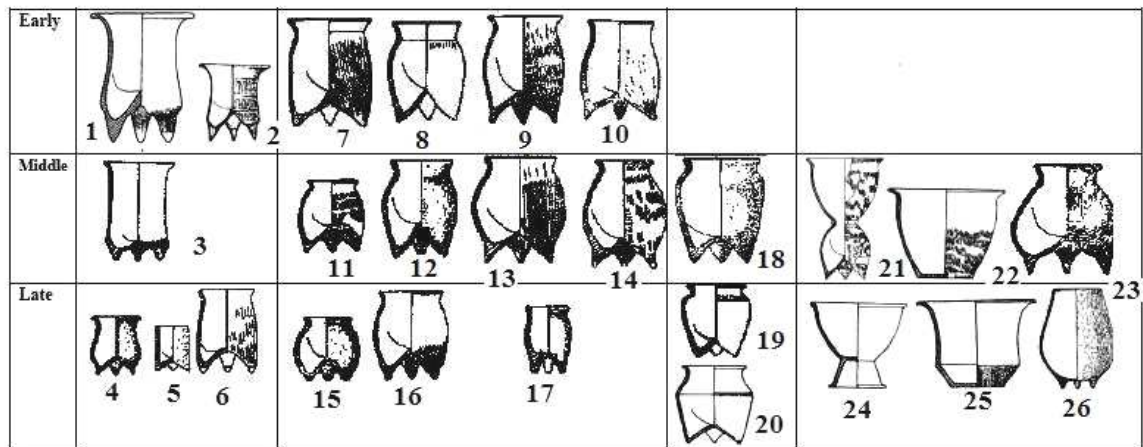


Fig. 111a. Datuotou culture, periodization of the sites, 1 Fenghuangshan; 2 Sanguan M2008:1; 3 Liulihe M1: 1; 4 Sishilipo II28:11; 5 Datuotou F1:8; 6 Zhangjiayuan 65T2④:1; 7 Weifang T2③: 9; 8 Xueshan H109:7; 9 Zhangjiayuan 79T1③:13; 10 Weifang T3③:13; 11 Datuotou F2:14; 12 Qianbao F1:7; 13 Zhangjiayuan T2②:8; 14 Datuotou F2:1; 15 Datuotou F1:5; 16 Weifang H3:2; 17 Guye 18 Xiaoshu :3 19 Datuotou F1:6; 20 Qinggongtai M1:22; 21 Datuotou H2: 16; 22 Datuotou H2: 17; 23 Sanguan H2022: 26; 24 Liulidian M1:3; 25 Qinggongtai M1:8; 26 Sanguan H2071:7.

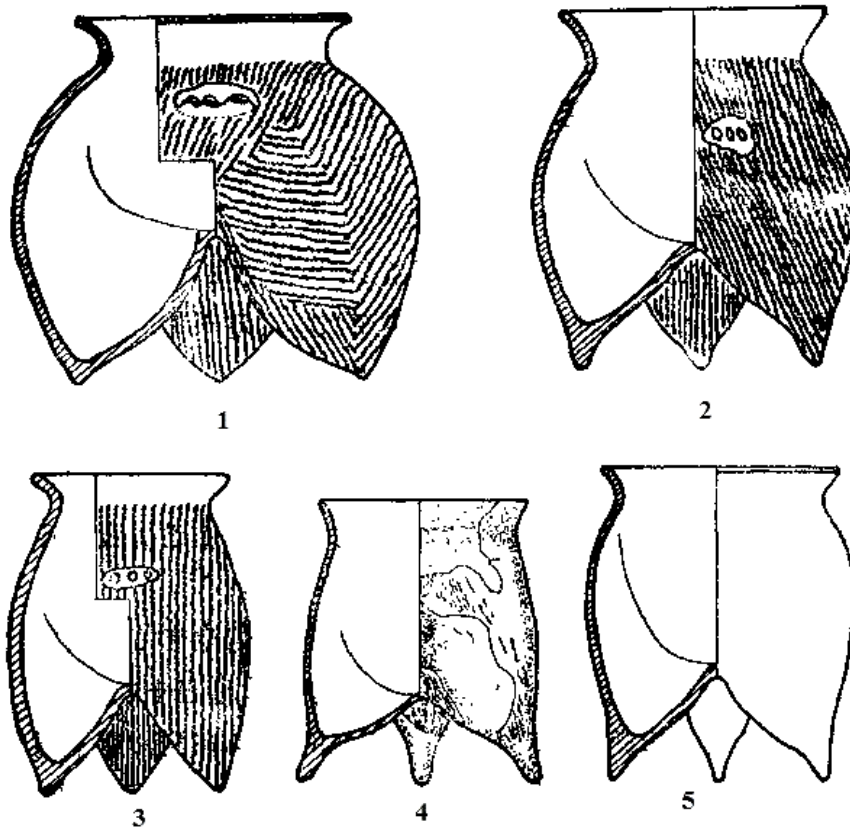


Fig. 111b. Xueshan II, potteries, 1 H66:7; 2 H66:32; 3 H66:228; 4 H66:233; 5 H66: 231 (after Han J. G. 1992, 299 Fig. 2).

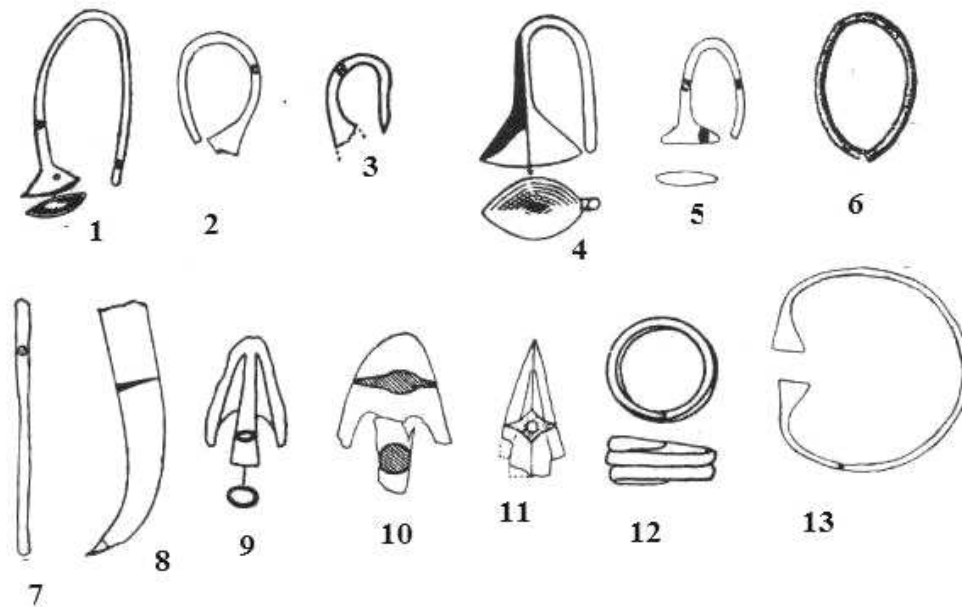


Fig. 111c. Datuotou culture, metal objects, 1.8 Weifang; 2.12 Lijiadian; 3 Tazhao; 4.10.11 Zhangjiayuan; 6 Sanguan; 7 Xiayuegezhuang; 9 Datuotou; 13 Qinggongtai (after Beifangcaoyuan 2007, 53 Fig. 21, 1.4.8.6.11.5.9.12.2.3.10.7.13).

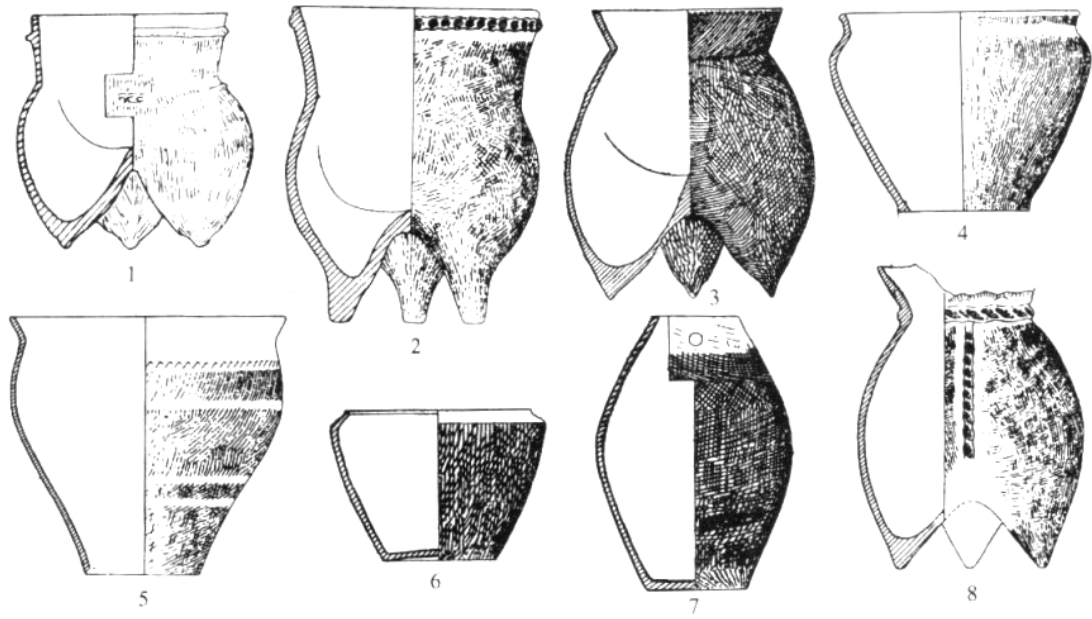


Fig. 112a. Weifang III culture, potteries, 1 Beifudi; 2 Guye; 3.6.7 Weifang; 4.5.8 Jiuncun (after Beifangcaoyuan 2007, 126 Fig. 56).

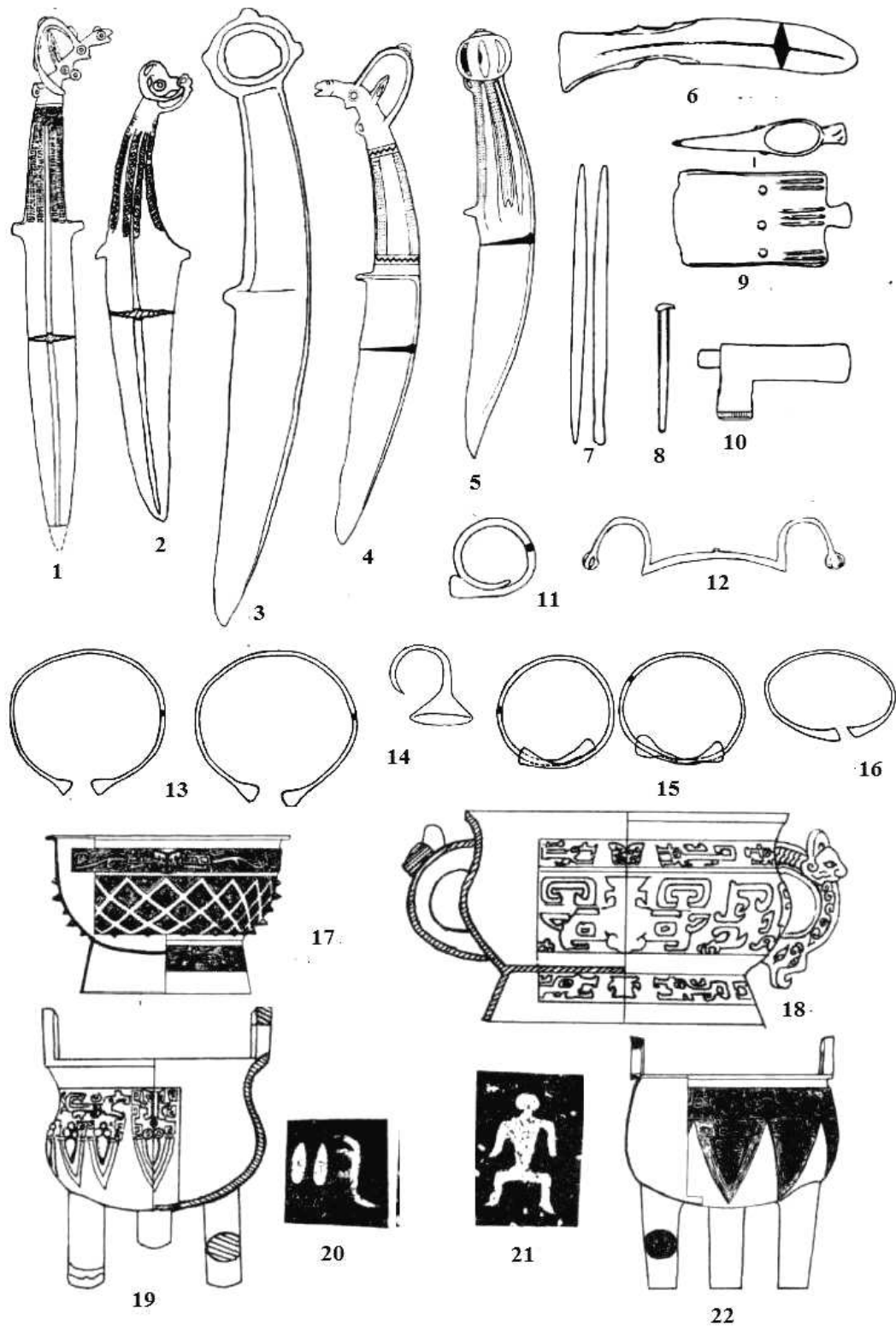


Fig. 112b. Weifang III culture, metal objects, 1-12, 18-23 bronze; 13-17 gold; - 1 Zhangjiakou; 2-5.10 Chadaogou; 6.9.16 Xiaoshandong; 7.11 Jiancun; 8 Weifang; 12 Chenshantou; 13.15.17.20-22 Zhangjiayuan; 14 Liujiahe; 18.19 Mashao (after Beifangcaoyuan 2007, 127 Fig. 57, 1-12; 132 Fig. 61, 1-4; 134 Fig. 62, 1-6).

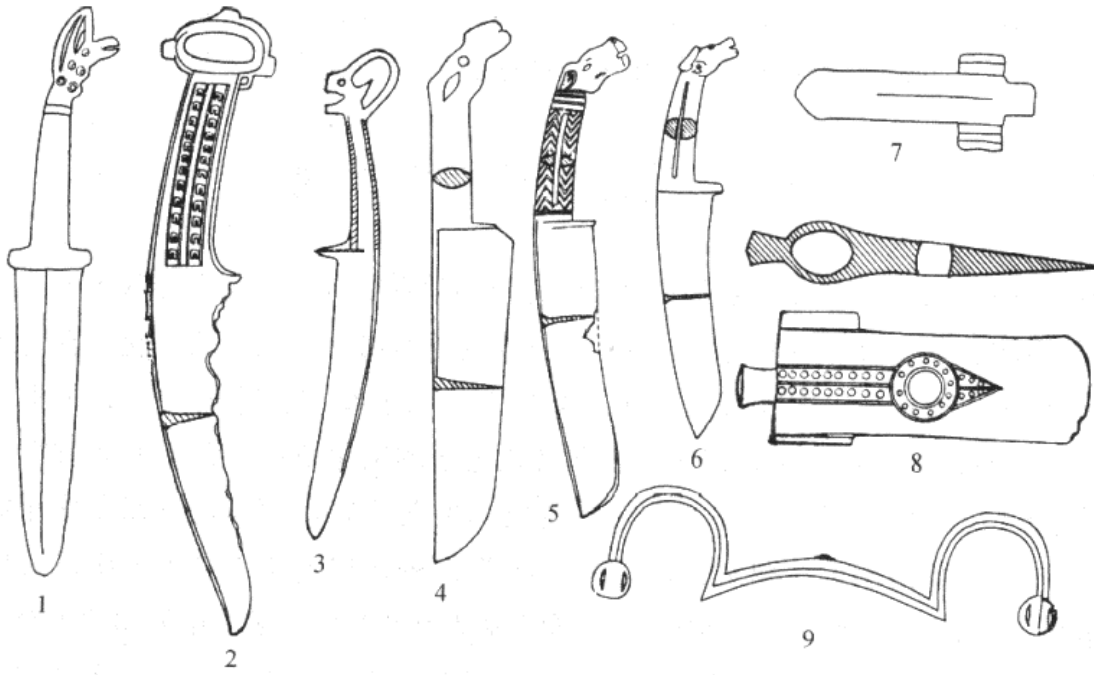


Fig. 112c. Northern bronzes found in central China during the Yinxu period, 1.3.9 Yinsu; 2.7.8 Dasikong; 4-6 Anyang (after Beifangcaoyuan 2007, 135 Fig. 63).

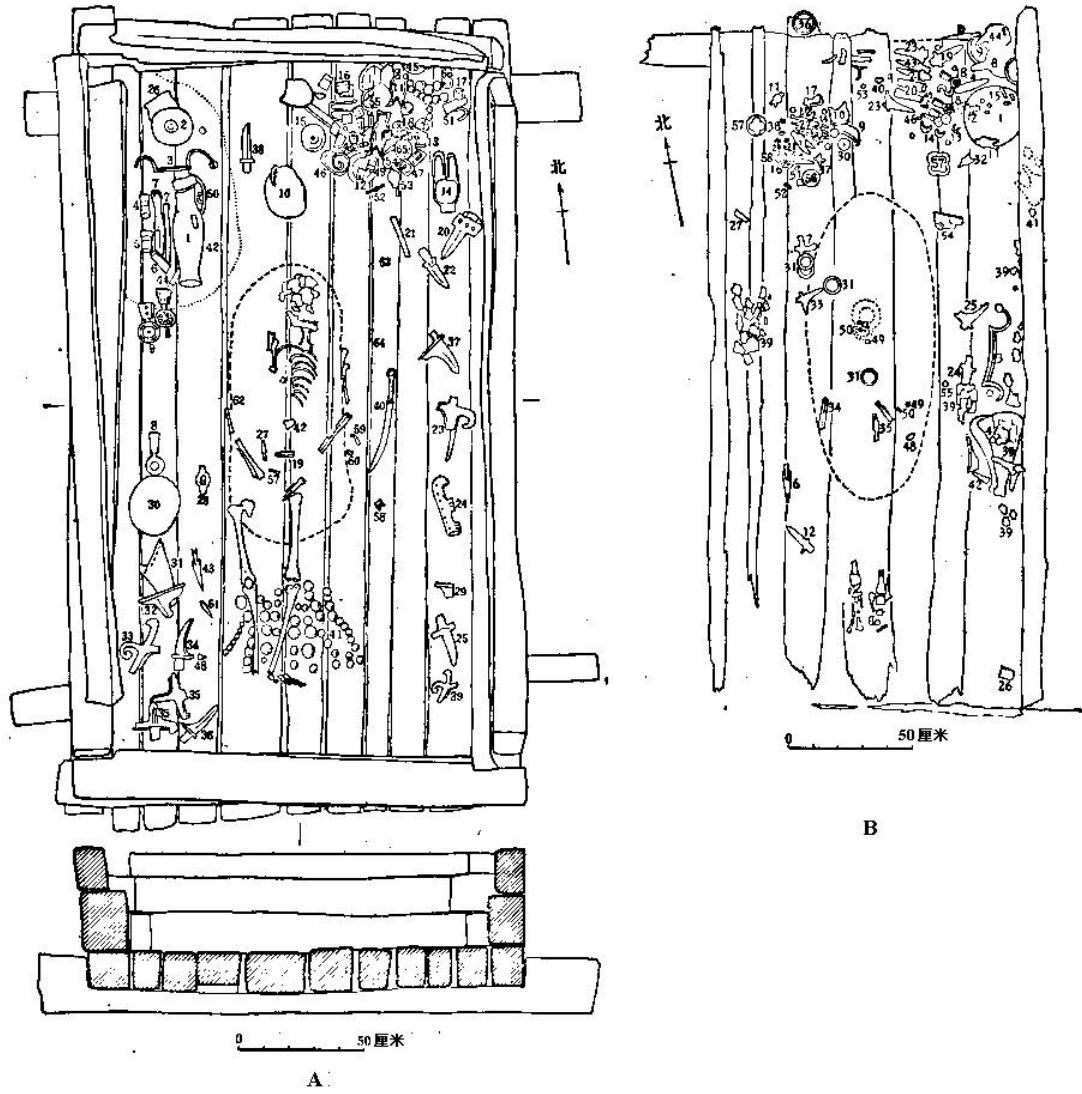


Fig. 113a. Baifu cemetery: A tomb M2, B tomb M3 (after BJWG 1976, 247 Fig. 2; Fig. 3).

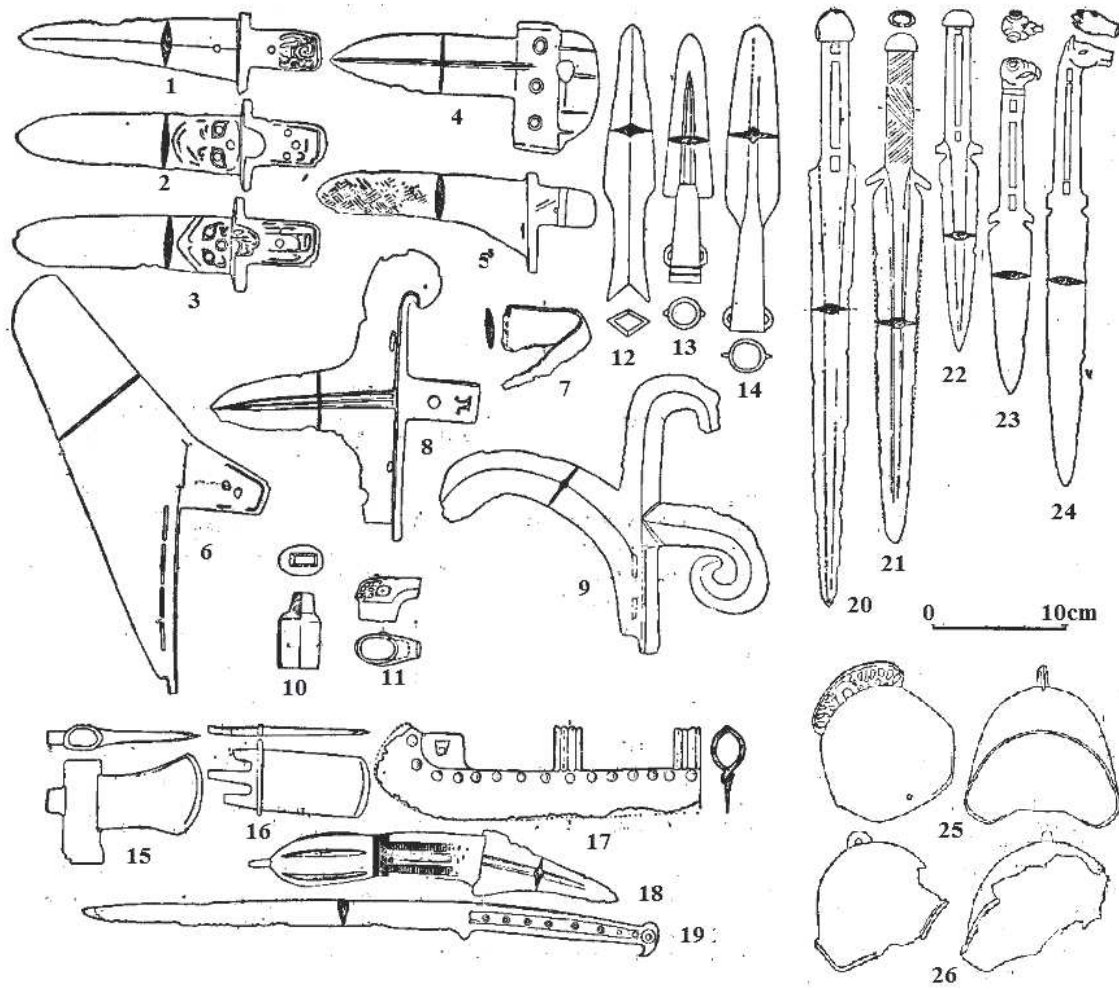


Fig. 113b. Baifu cemetery, bronze objects, 25.26 helmet, H 23cm (after BJWG 1976, 252 Fig. 7, 1-14; 252 Fig. 8, 1-5; 253 Fig. 9, 1-5; 253 Fig. 10, 1-2).

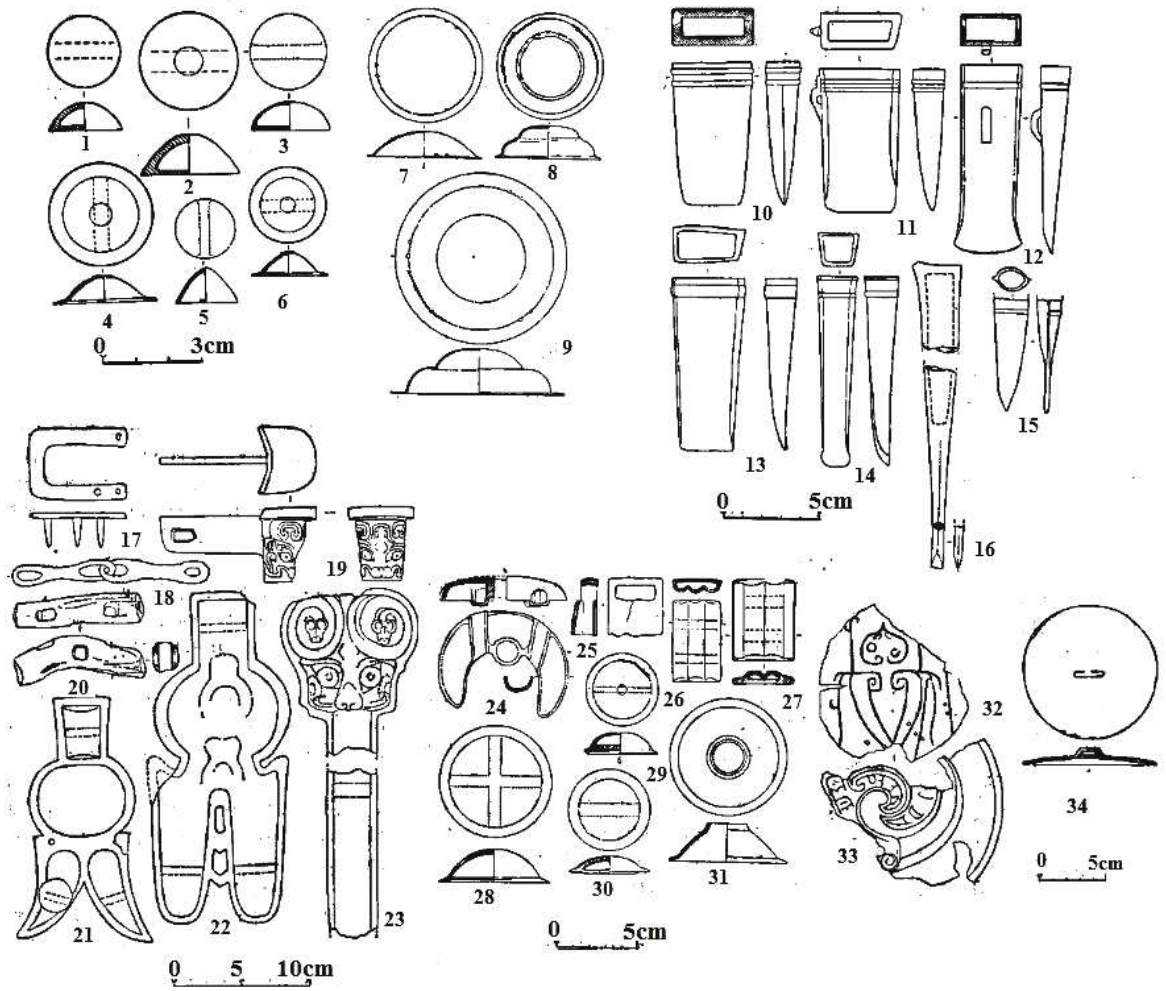


Fig. 113c. Baifu cemetery, bronze objects, 7-9 shield, diameter, 10.5-15cm (after BJWG 1976, 253 Fig. 11, 1-6; 254 Fig. 12, 1-3; 254 Fig. 13, 1-7; 257 Fig. 18, 1-7; 257 Fig. 19, 1-5; 257 Fig. 20, 1.3.4).

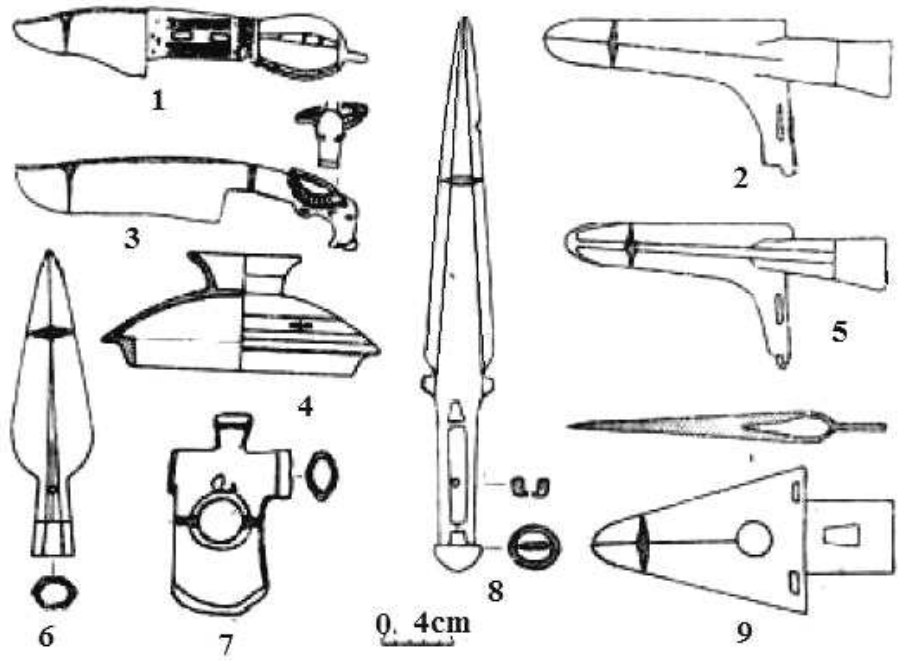


Fig. 114. Xiaohenan, bronze objects (after Wang F. 1990, 58 Fig. 2, 1-9).

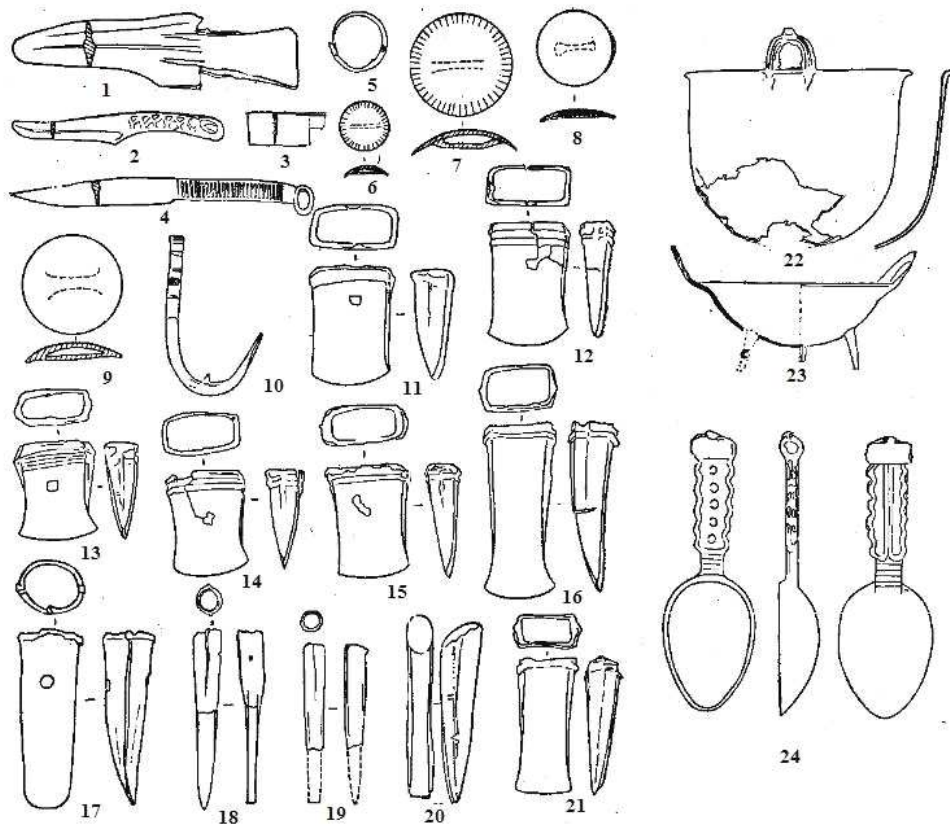


Fig. 115. Xibozi, bronze objects (after BJWG 1979, 229 Fig. 4, 1-21; 228 Fig. 2, 1-3).

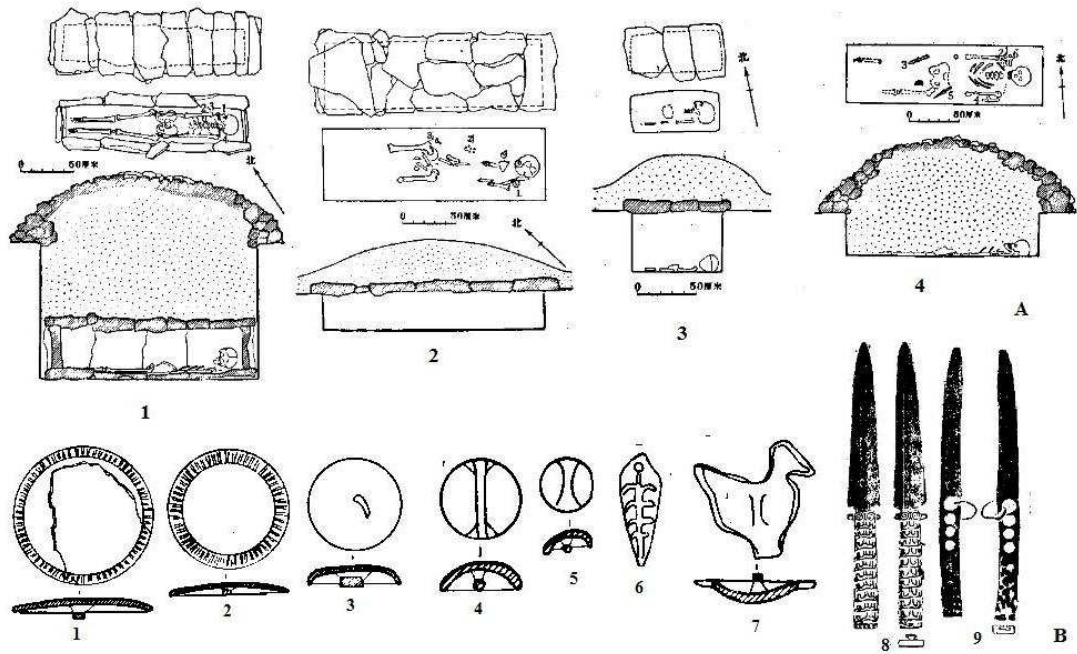


Fig. 116. Dongnangou cemetery, tombs and funeral goods, A tombs, 1 M10; 2 M4; 3 M8; 4 M6 (after Zheng S. Z. 1977, 52 Fig. 2, Fig. 3; 53 Fig. 4, Fig. 5); B bronze objects (after Zheng S. Z. 1977, 54 Fig. 7, 1-3; 54 Fig. 8, 1.2.8.10; 53 Fig. 6, 1-2).

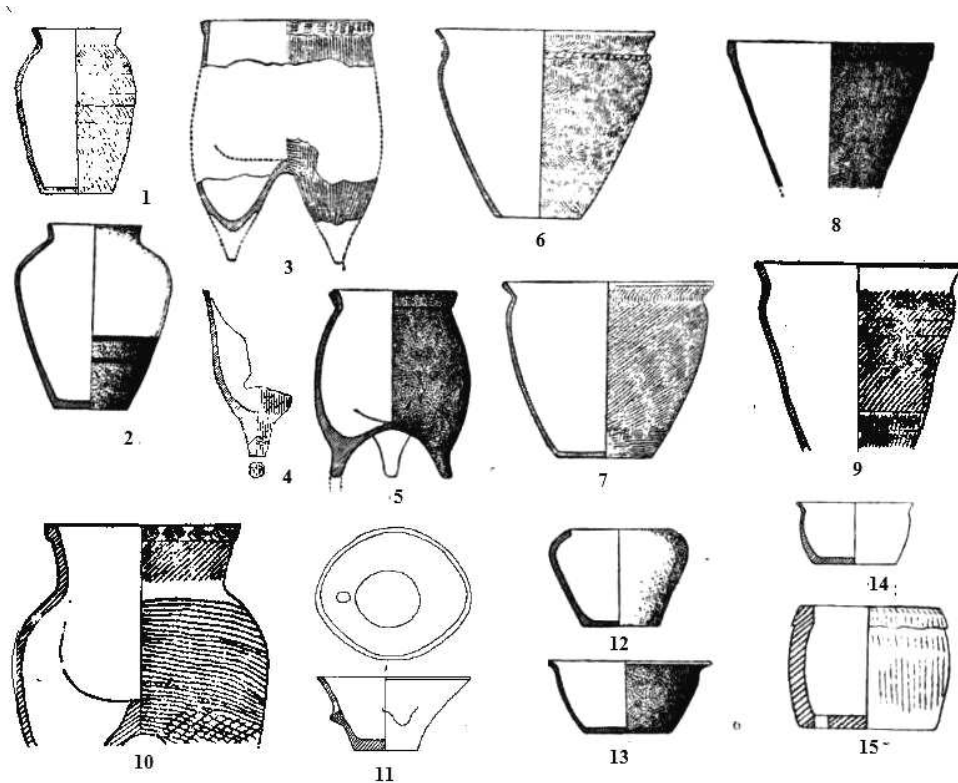


Fig. 117a. Upper Zhangjiayuan culture, potteries, 1.4.9.10.14.15 Zhangjiayuan 2.8.12.13 Guye; 3.5.6.7 Tanshan; 11 Donggoudao (1.4 after TJW 1979, 168 Fig. 11, 1.3; 2.3.5-8.12-15 after Beifangcaoyuan 2007, 260 Fig. 119, 10.1.2.4.3.7.5.9.5.8; 9.10 after TJLBK 1993, 319 Fig. 8, 6.1; 11 after Bai G. 1999, 26 Fig. 14).

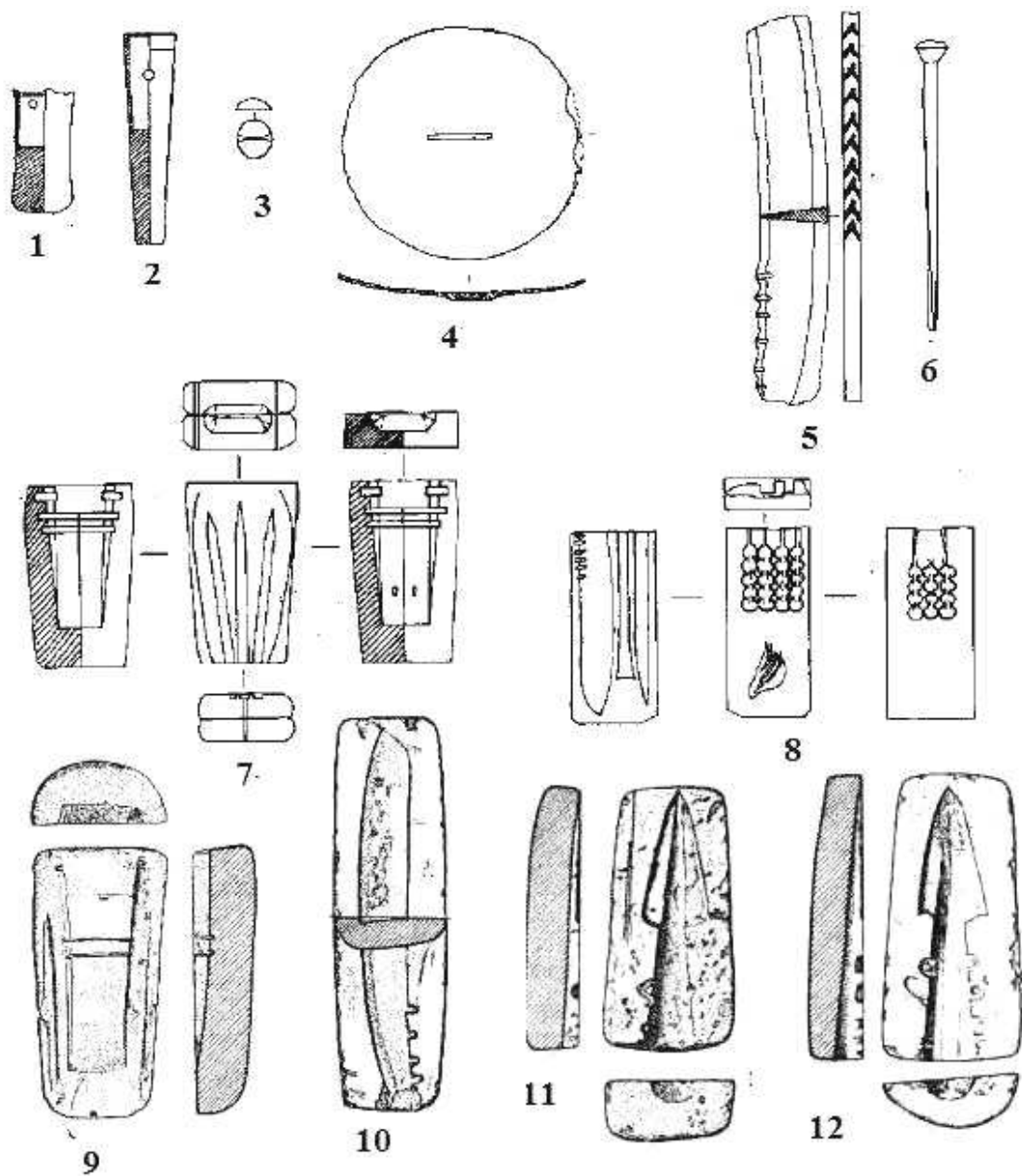


Fig. 117b. Upper Zhangjiayuan culture, bronze objects and molds, 1-6 bronze objects; 7-12 stone molds; 1-8 Donggoudaoxia; 9-12 Baoshenmiao (after Bai G. 1999, 25 Fig.9, 6.3.5.1.2.4; 25 Fig. 10, 1.2; An Z. M. 1954, 83 Fig. 3, Fig. 4; 84 Fig. 5, Fig. 6).

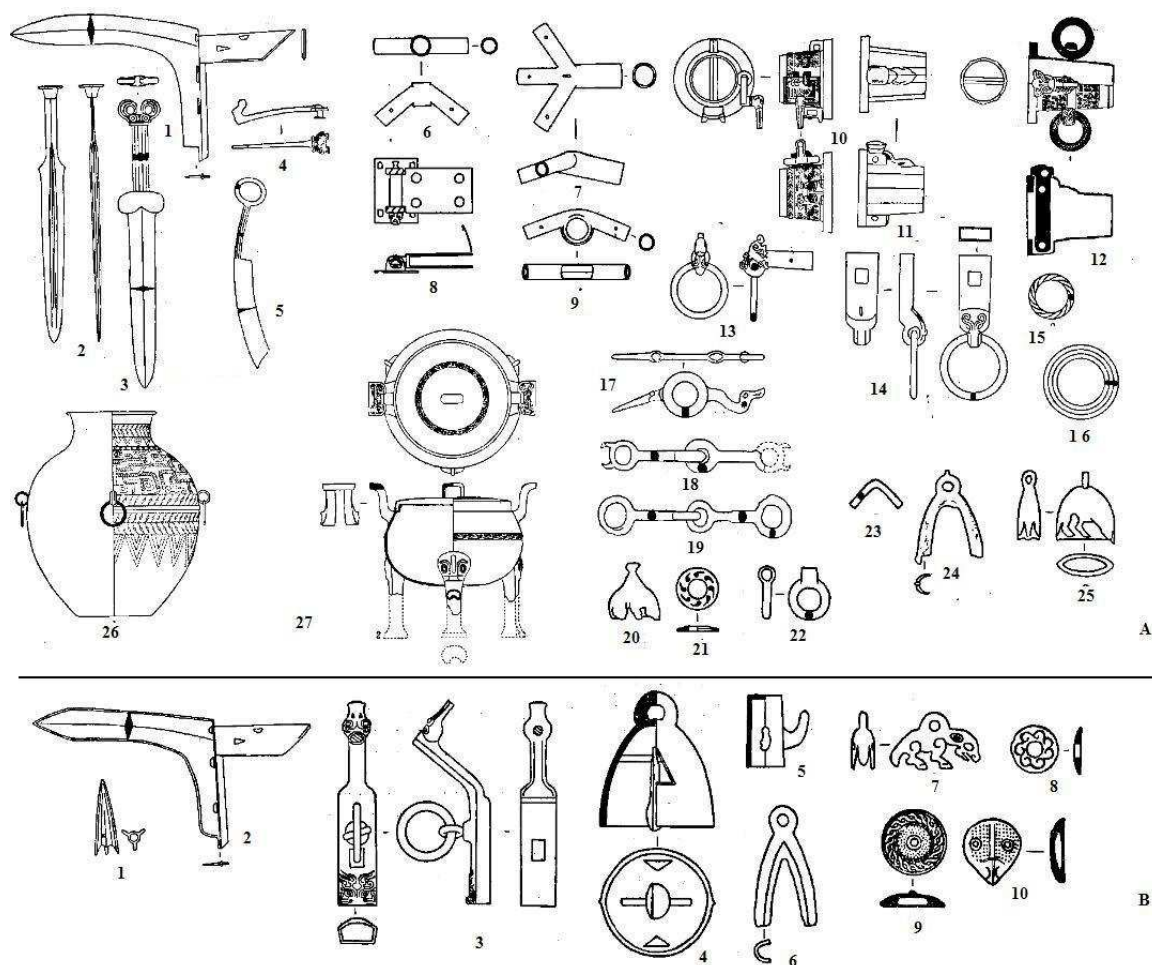


Fig. 118. Beixinbao, metal objects, B 9.10 gold; others bronze, A-M1 (after HBWW 1966, 235 Fig. 6, 1.2.7.3.6; 236 Fig. 7, 1-4; 237 Fig. 8, 1.2.6.4.7.3.5.8-10; 238 Fig. 9, 6.4.9.8.2.3; 234 Fig. 5, 1-2); B-M2 (after HBWW 1966, 240 Fig. 12, 1-2; 241 Fig. 13; Fig. 14, 1.2.5.3.7.8.6).

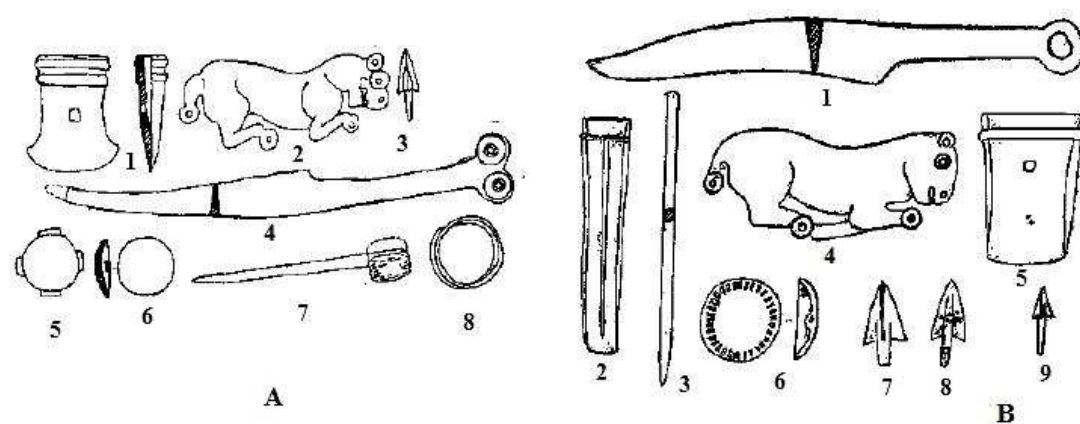


Fig. 119. Qingzigou, bronze objects, A 76M18; B 76M16 (after Zheng S. Z. 1984, 45 Fig. 7, 1-3, 6-10; 46 Fig. 9, 1-9).

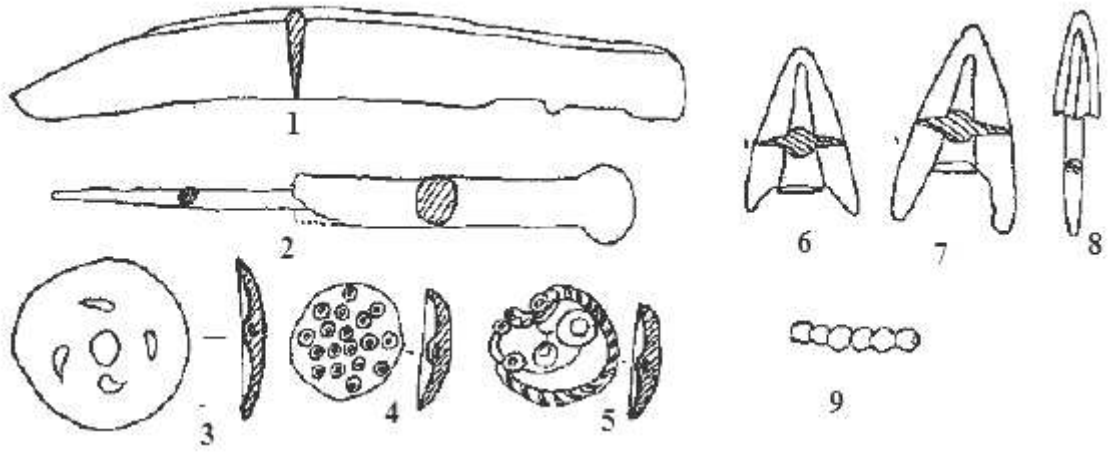


Fig. 120. Luotuoliang, bronze objects (after Zheng S. Z. 1984, 46 Fig. 8, 1-8.10).

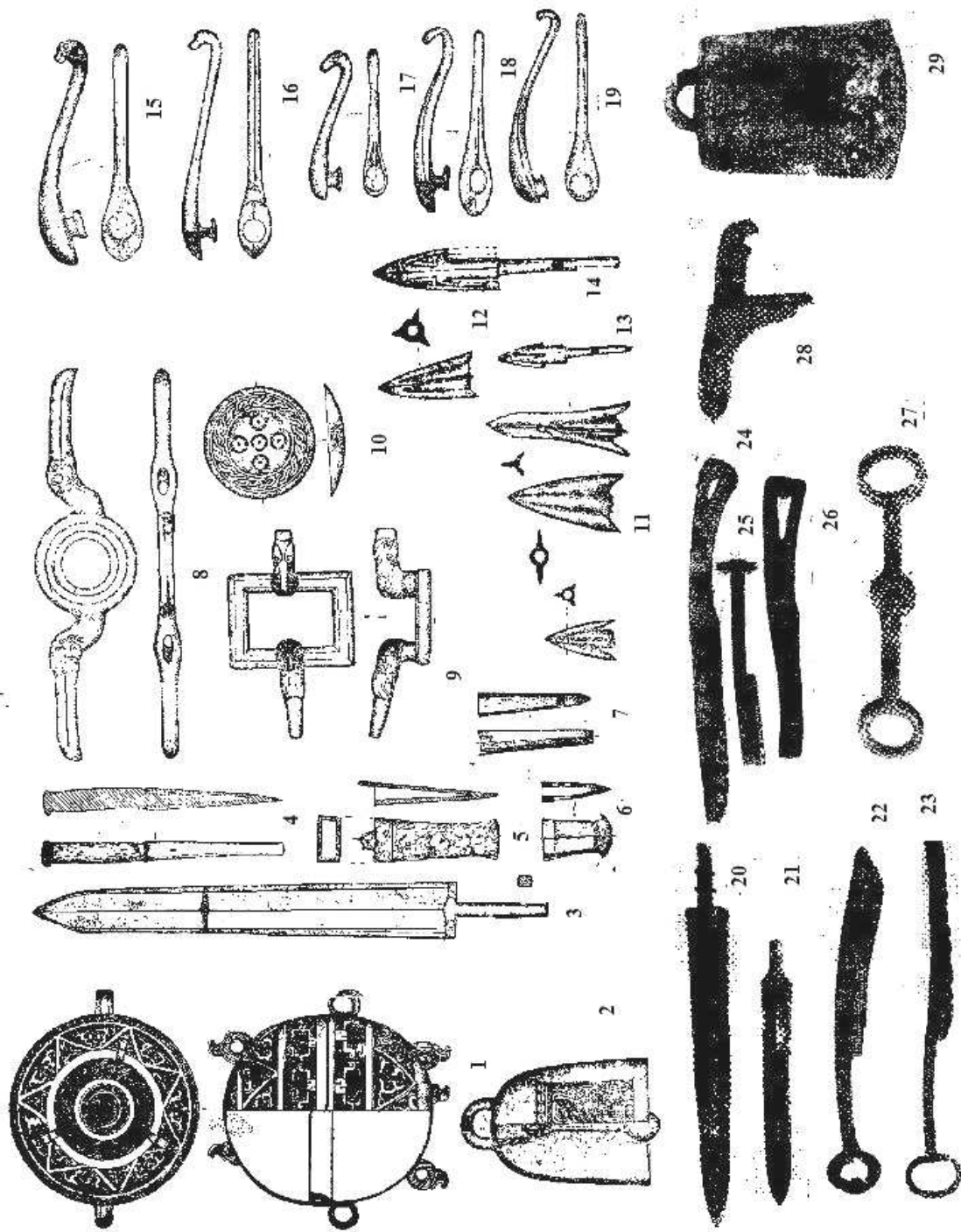


Fig. 121. Paotaishan, bronze objects (after Zheng S. Z. 1983, 69 Fig. 4; 70 Fig. 5, 18.1-3.14.13.6.7.9.10; 71 Fig. 7, 5.6.4; 70 Fig. 5, 4.5.15-17; 72 Fig. 11, Fig. 12, Fig. 8-10, Fig. 15; 73 Fig. 16; 72 Fig. 13).

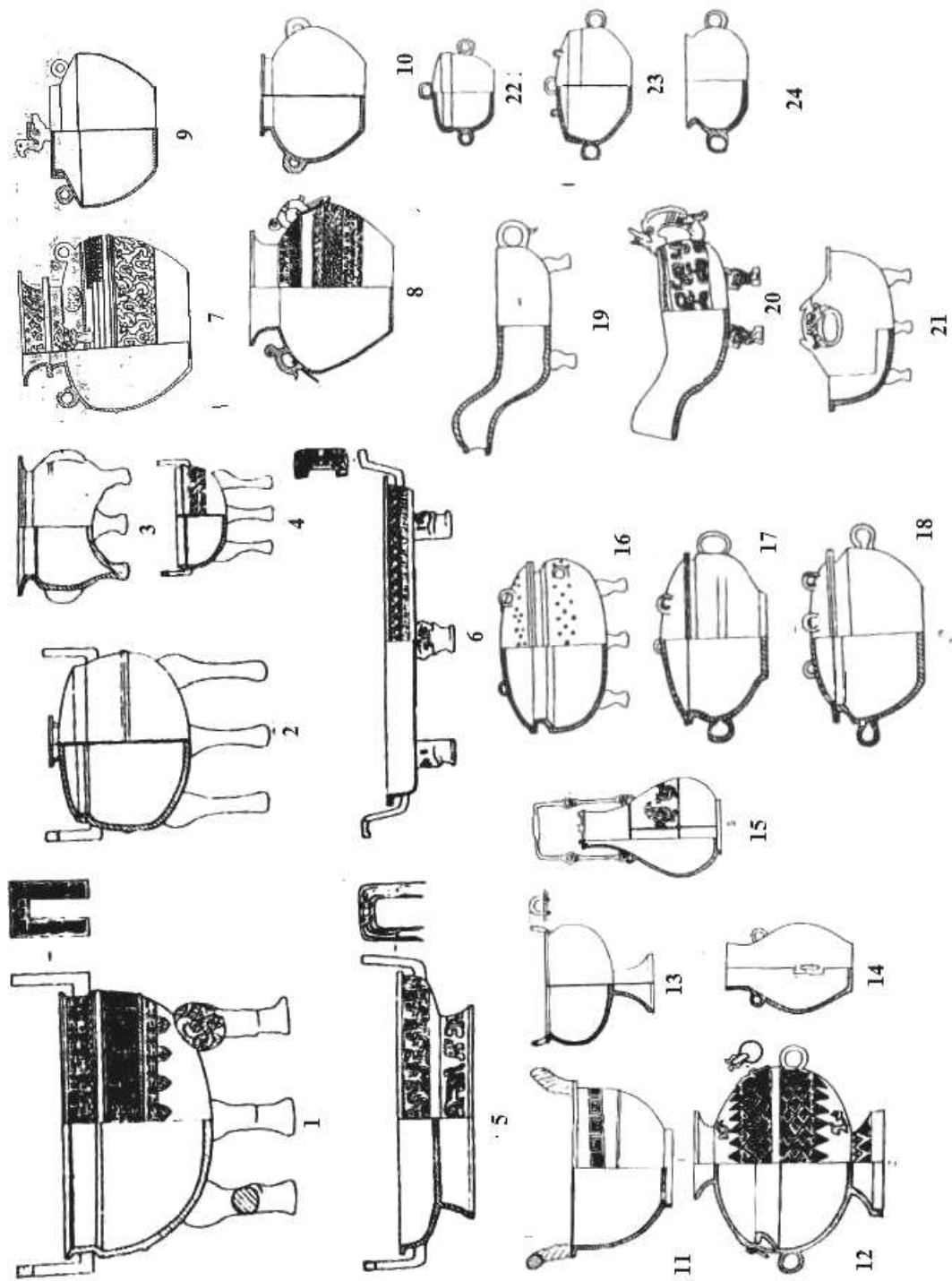


Fig. 122a. Ganzibao, bronze ritual objects (after He/Liu 1993, 24 Fig. 2, 1-6; 25 Fig. 3, 1-4; Fig. 4, 1-5; 26 Fig. 5, 1-9).

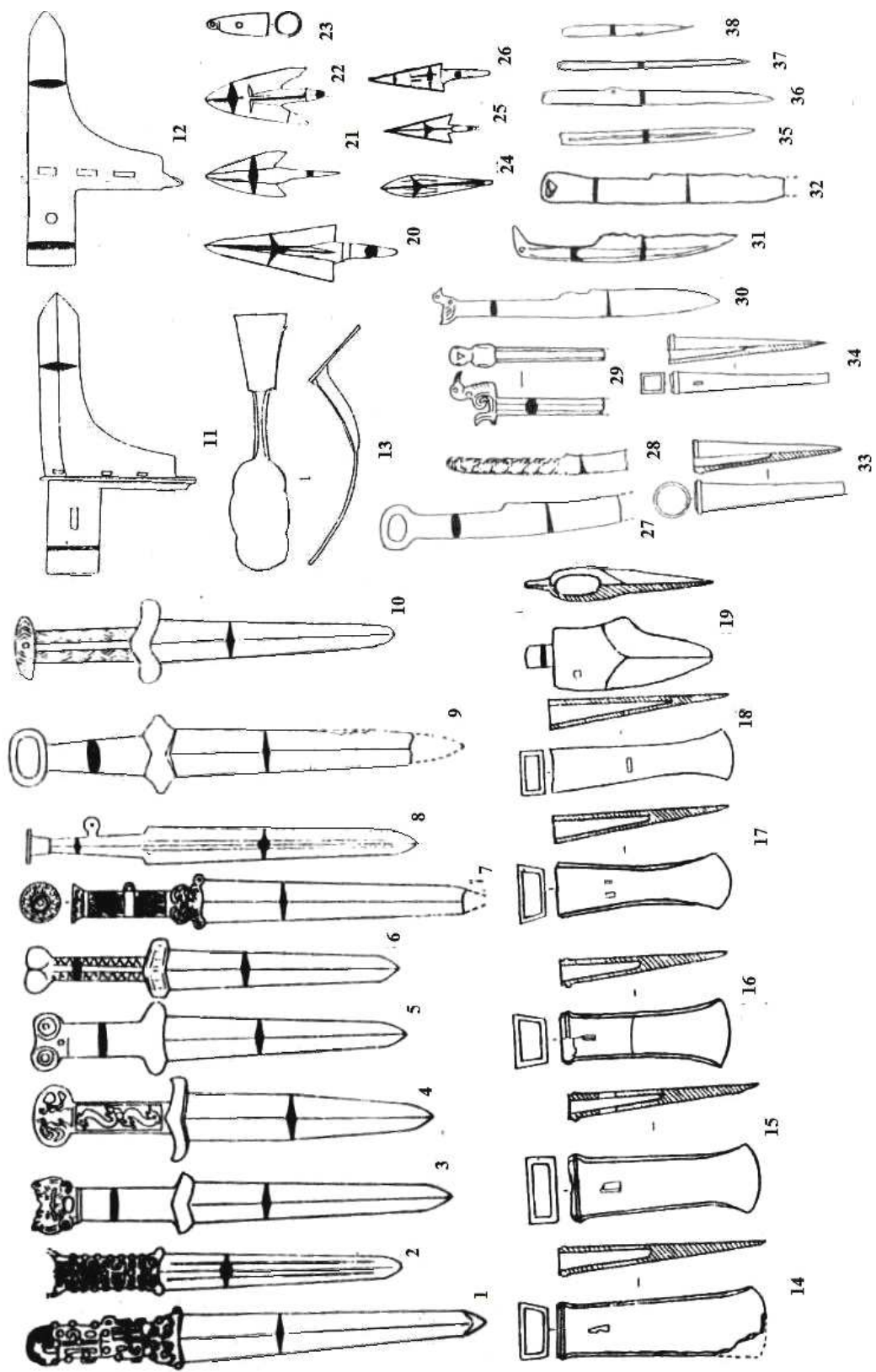


Fig. 122b. Ganzibao, bronze objects (after He/Liu 1993, 29 Fig. 7, 1-10; 28 Fig. 6, 1-3; 30 Fig. 8, 1-6; 32 Fig. 11, 1-6; 32 Fig. 12, 2-7).

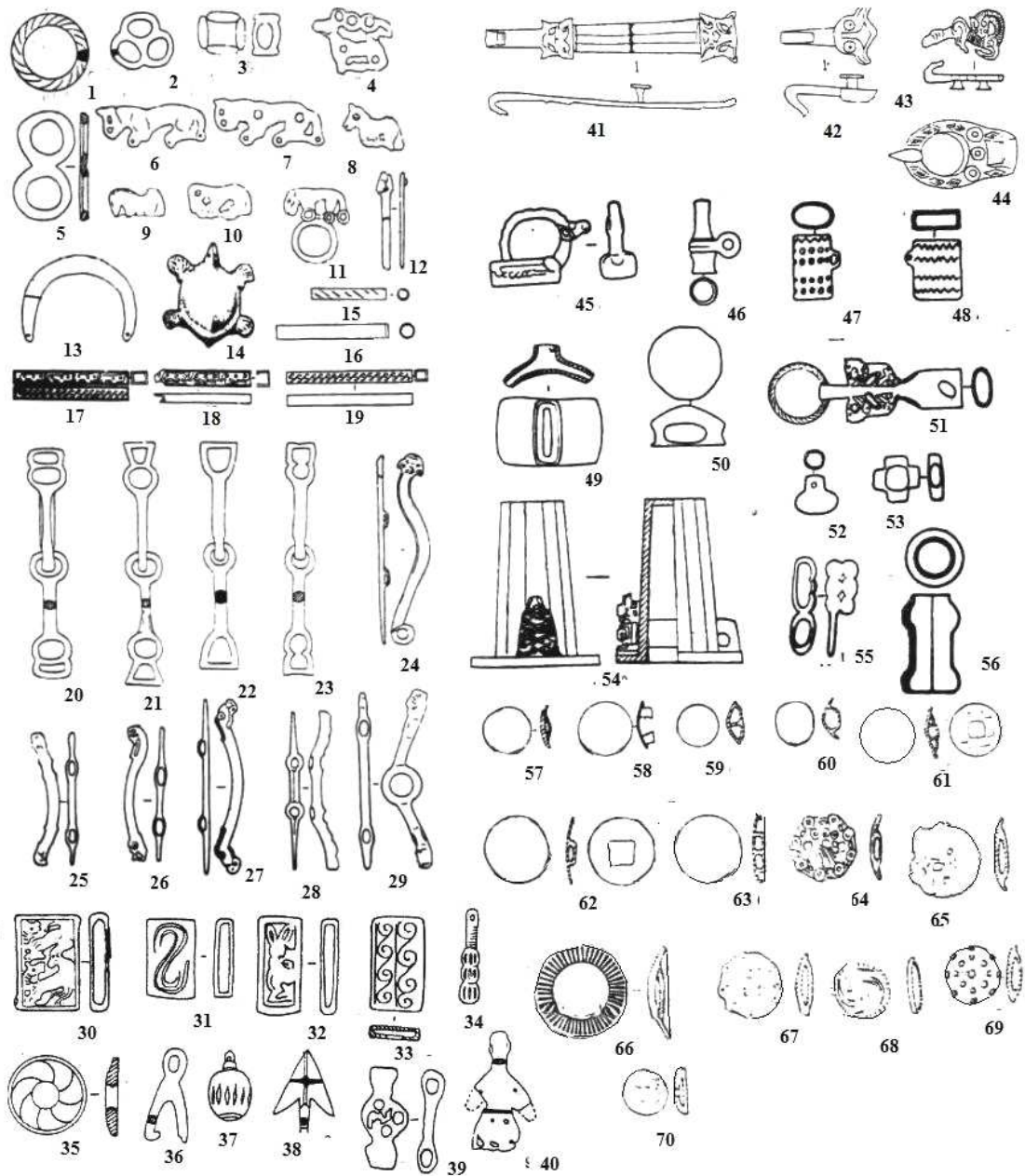


Fig. 122c. Ganzibao, metal objects, 7.13 gold; others, bronze (after He/Liu 1993, 31 Fig. 9, 1-19; Fig. 10, 1-10; 37 Fig. 16, 1.2.10.11.7.3.4.8.5.9; 33 Fig. 13, 2.3.7.9; 35 Fig. 14, 1-12; Fig. 15, 1-14).

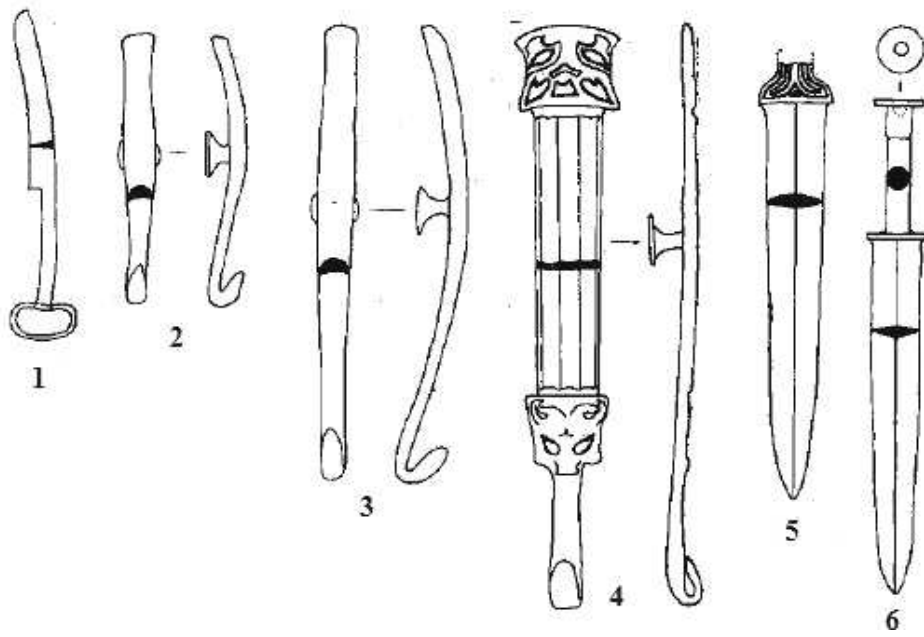


Fig. 123. Baimiao, bronze objects (after ZJKW 1985, 28 Fig. 9, 2-4.7.5.6).

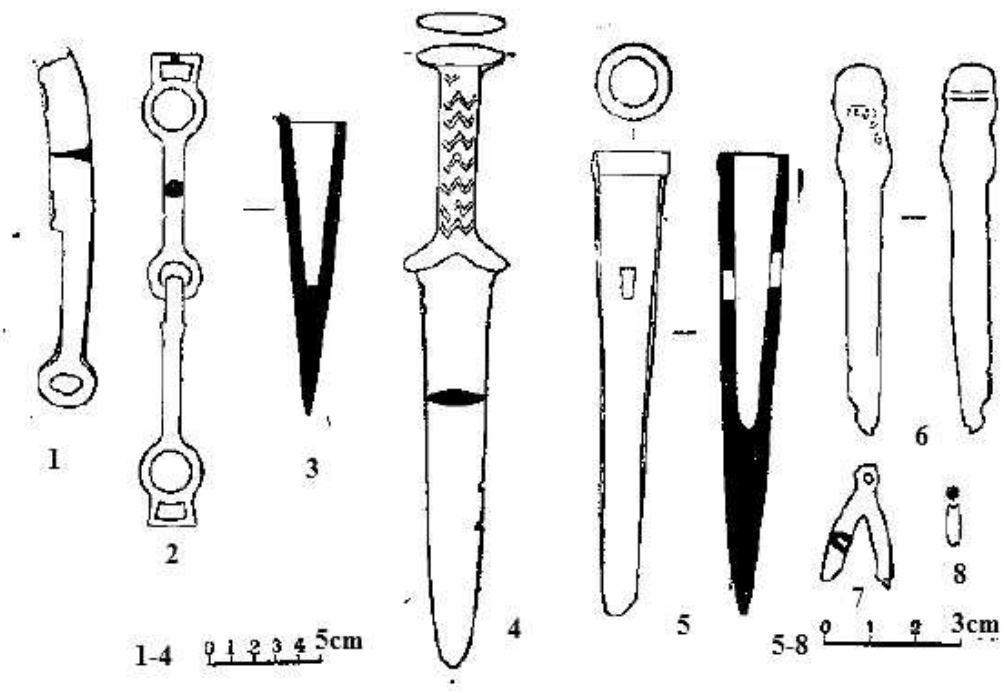


Fig. 124. Nihezi, bronze objects (after Zhang/Tao, 1983, 94 Fig. 5, 1-4; 95 Fig. 6, 1-4).

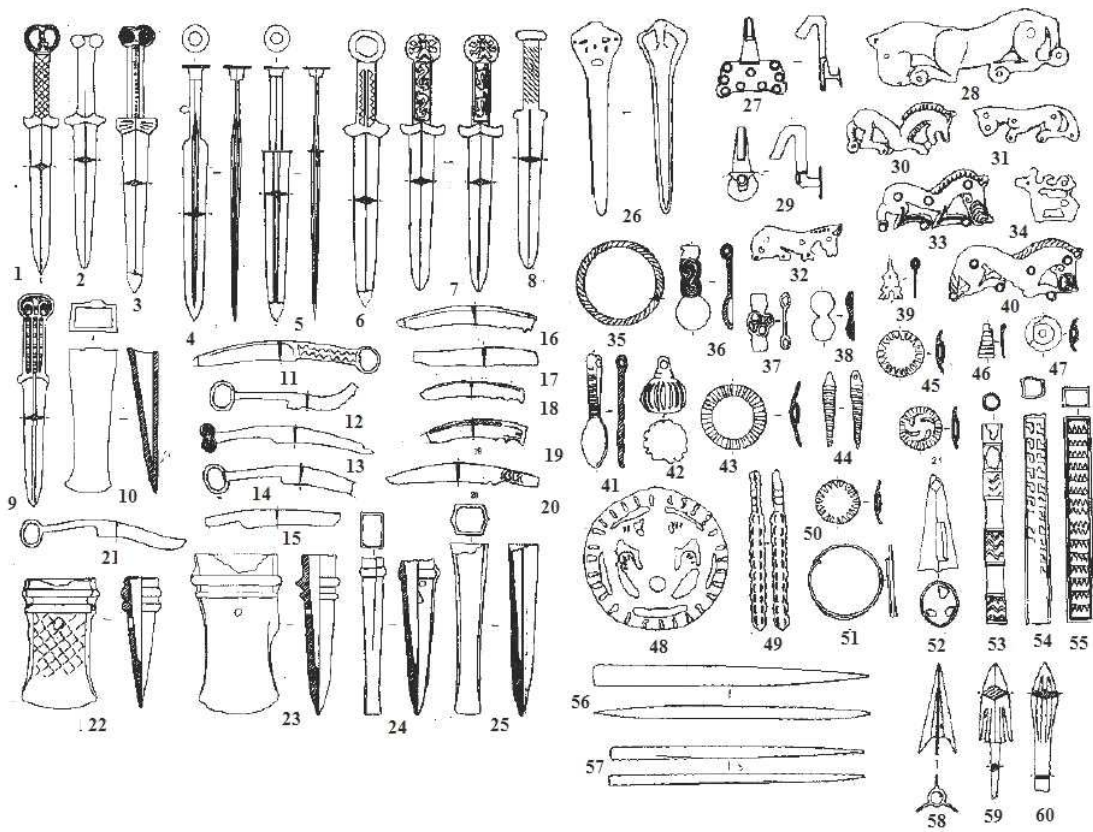


Fig. 125. Xiaobaiyang, bronze objects (after Tao Z. Y. 1987, 46 Fig. 13, 1-25; 48 Fig. 15. 1-31; 47 Fig. 14, 1.5.11.14.16).

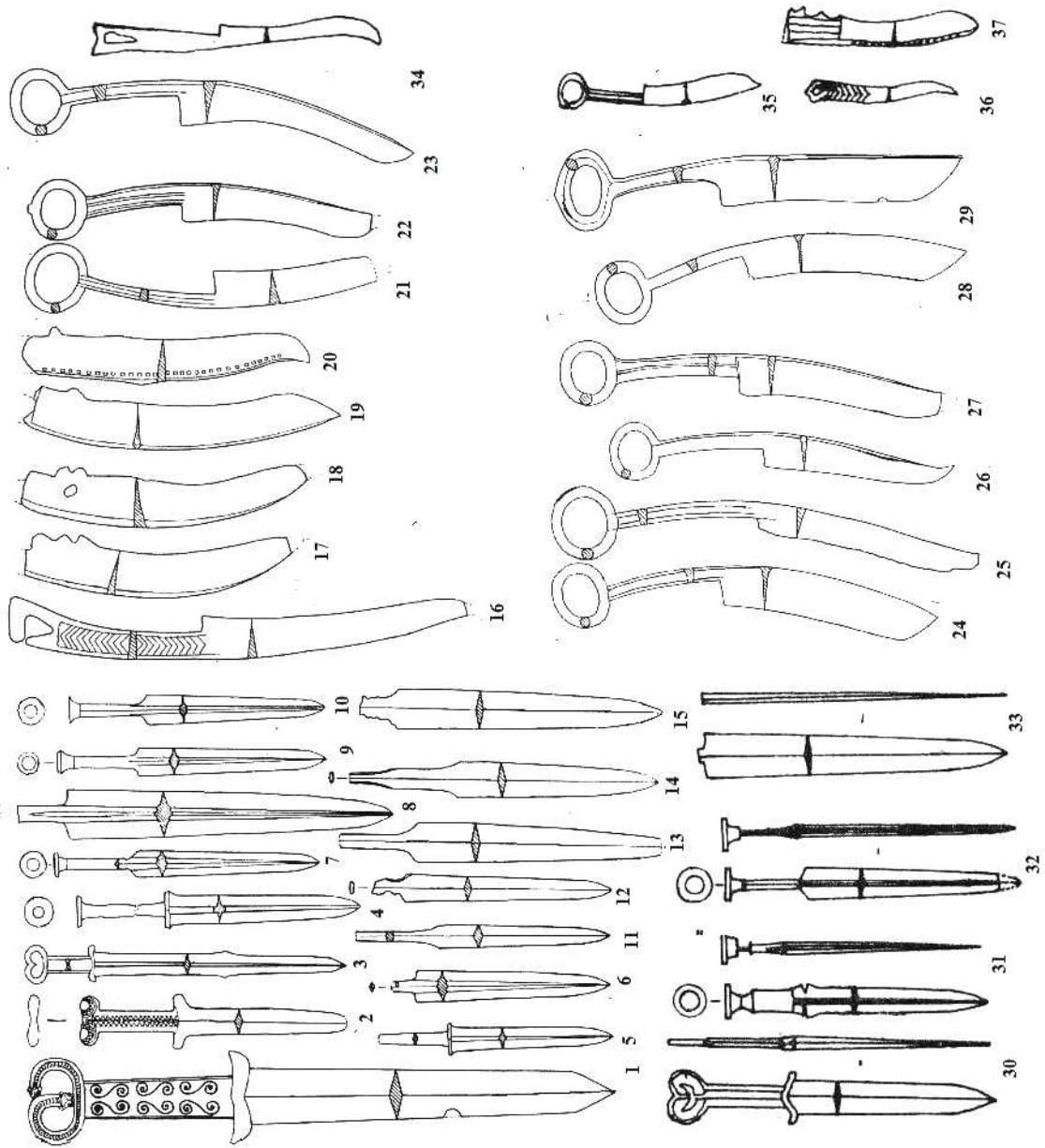


Fig. 126a. Lishugoumen, bronze objects, 1-15.30-33 sword; 16-29.34-37 knives (after CDW et al. 1994, 21 Fig. 7, 1-15; 22 Fig. 8, 4-8.11.10.9; 23 Fig. 9, 11-14.17.16; LPB 1995, 11 Fig. 5, 1-5.7.6.8).

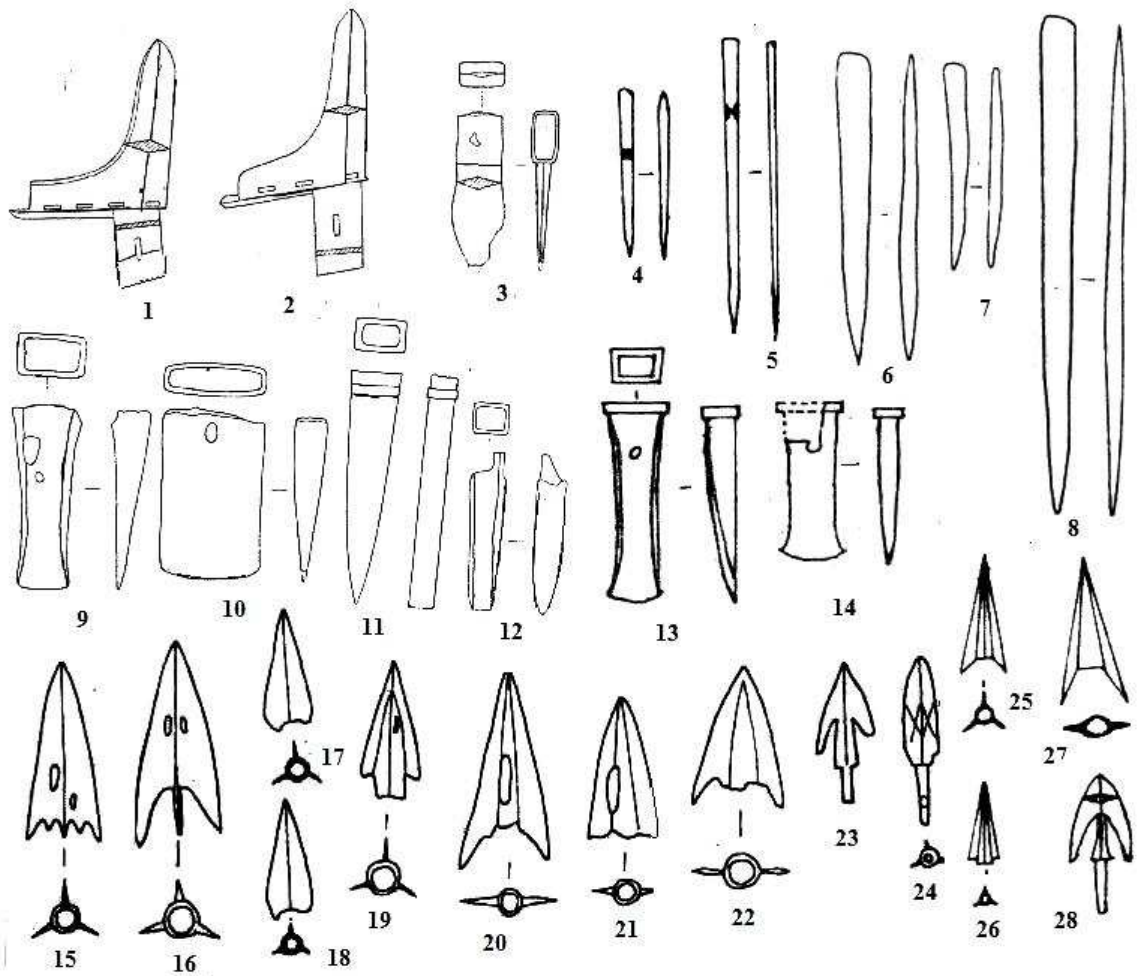


Fig. 126b. Lishugoumen, bronze objects, 1-2 Ge; 3.9-14 adz and axe; 4-8 awl; 15-29 arrowheads (after CDW et al. 1994, 22 Fig. 8, 1-3; LPB 1995, 12 Fig. 6, 5-6; CDW et al. 1994, 24 Fig. 10, 2.3.1; 23 Fig. 9, 19-21; LPB 1995, 11 Fig. 5, 9.10; CDW et al. 1994, 24 Fig. 10, 6-16; LPB 1995, 1-4).

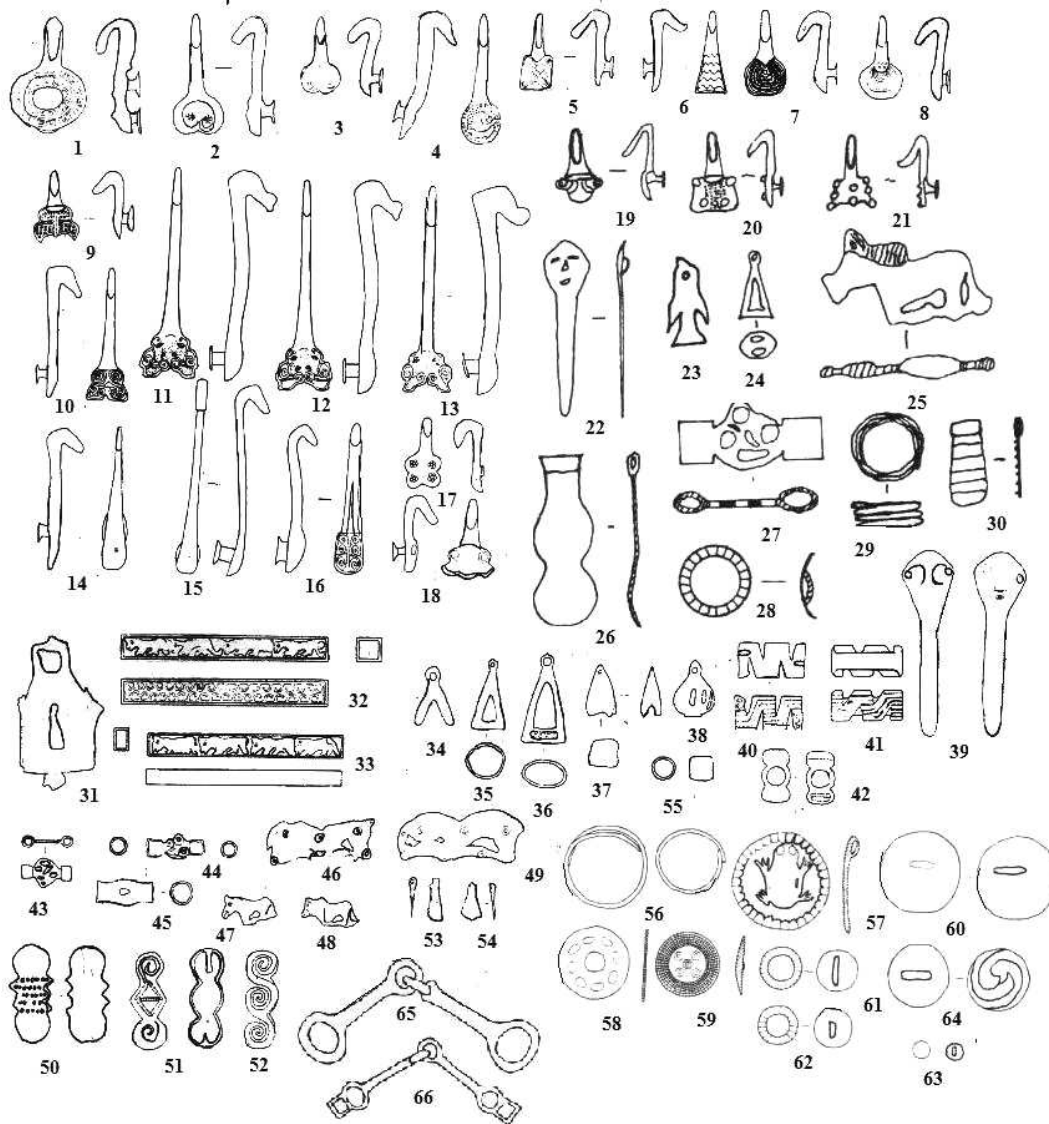


Fig. 126c. Lishugoumen, bronze objects (after CDW et al. 1994, 25 Fig. 11, 1-18; LPB 1995, 13 Fig. 7, 2-4.1.5-12; CDW et al. 1994, 26 Fig. 1-25; 27 Fig. 13, 1-8; 24 Fig. 10, 4.5).

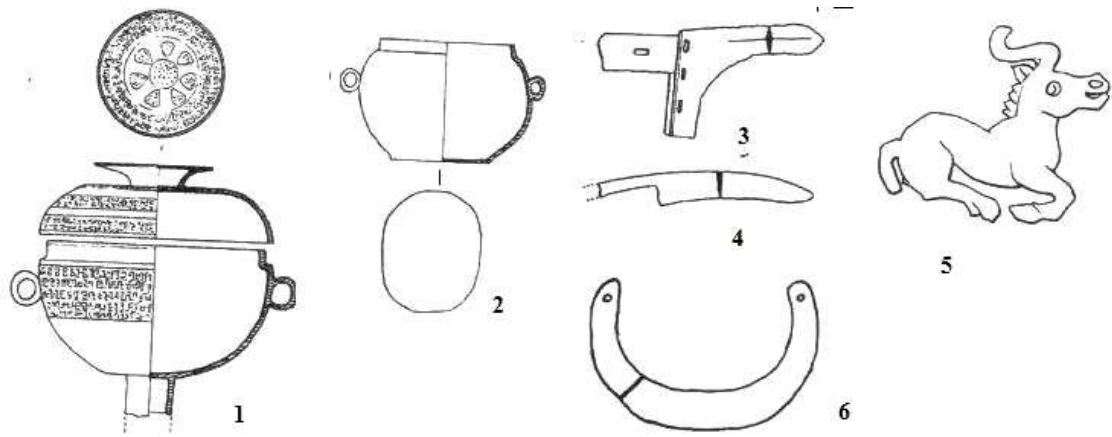


Fig. 127. Daolazui, metal objects, 1-5 bronze; 6 gold - 1 Dou, H 16.7cm; 2 vessel, H 8.4cm; 3 Ge, L 20.8cm; 4 knife, L 15cm; 5 figure; H 5.4cm; 6 necklace, H 37cm (after Chen X. 1999, 31 Fig. 1, 3.4.5.6.1.2).

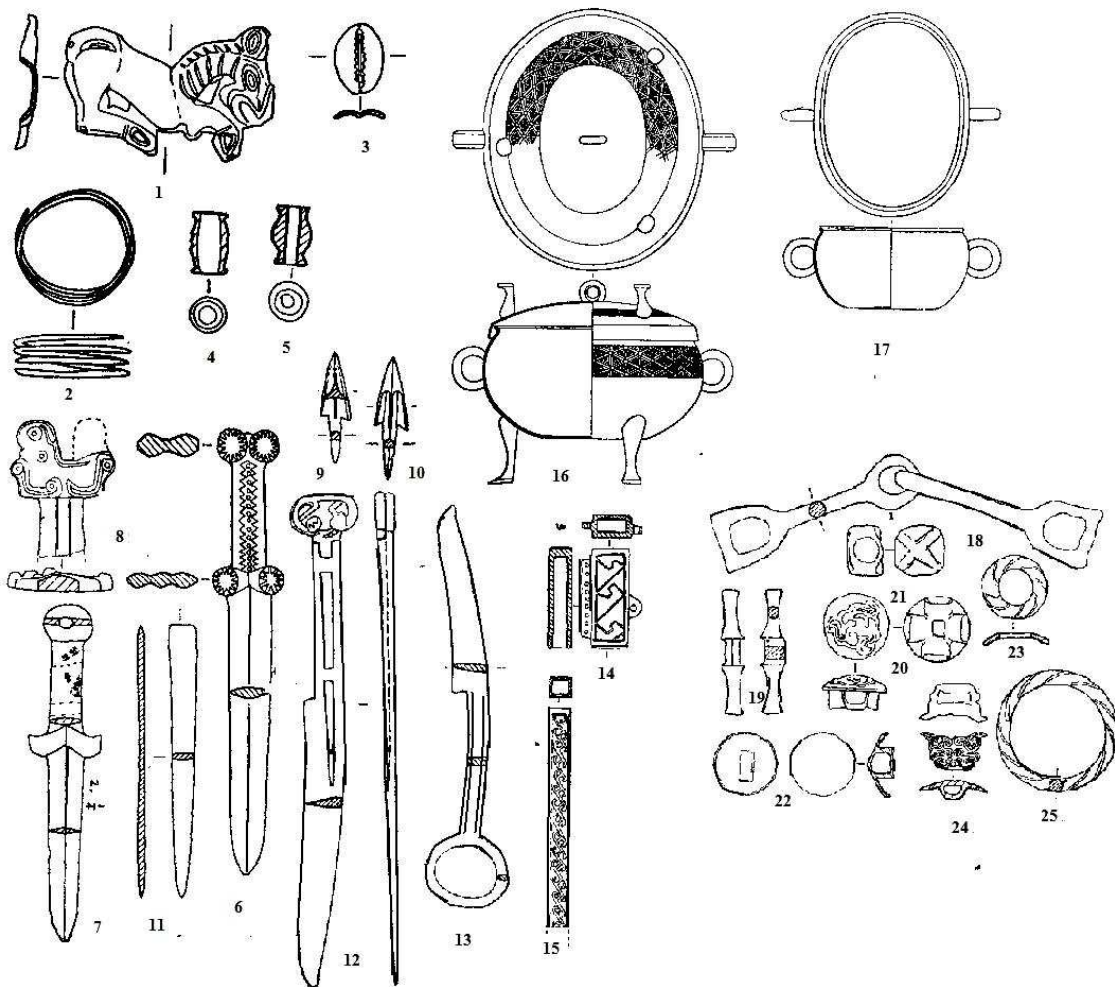


Fig. 128a. Longqingxia, metal objects, 1-5 gold; 6-25 bronze (after BJWY 1994, 37 Fig. 6, 1-5; 38 Fig. 9, 1-6; 39 Fig. 10, 1-4; 37 Fig. 6, Fig. 9; 40 Fig. 11, 1-8).

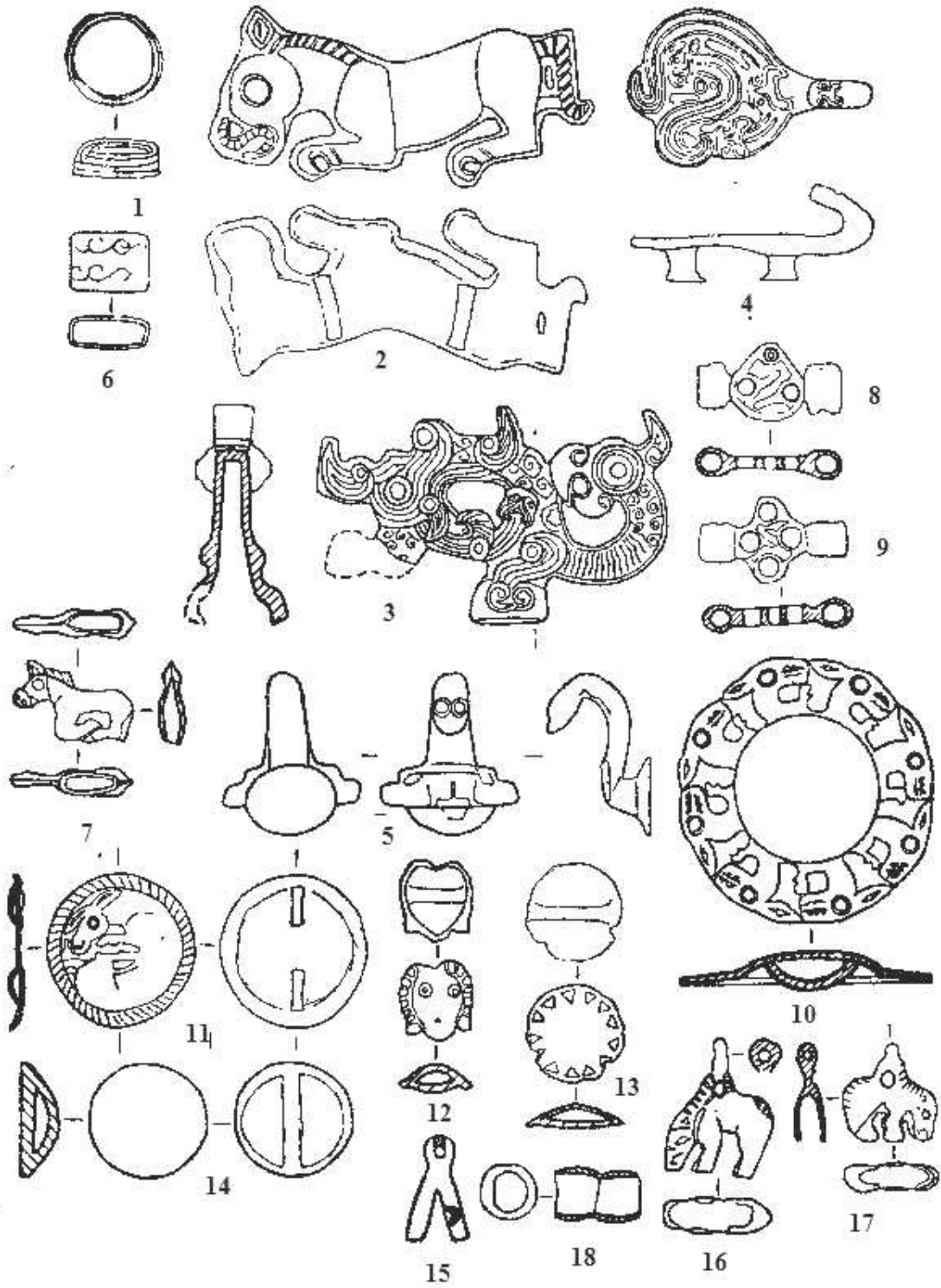


Fig. 128b. Longqingxia, bronze objects (after BJWY 1994, 41 Fig. 12, 1-18).

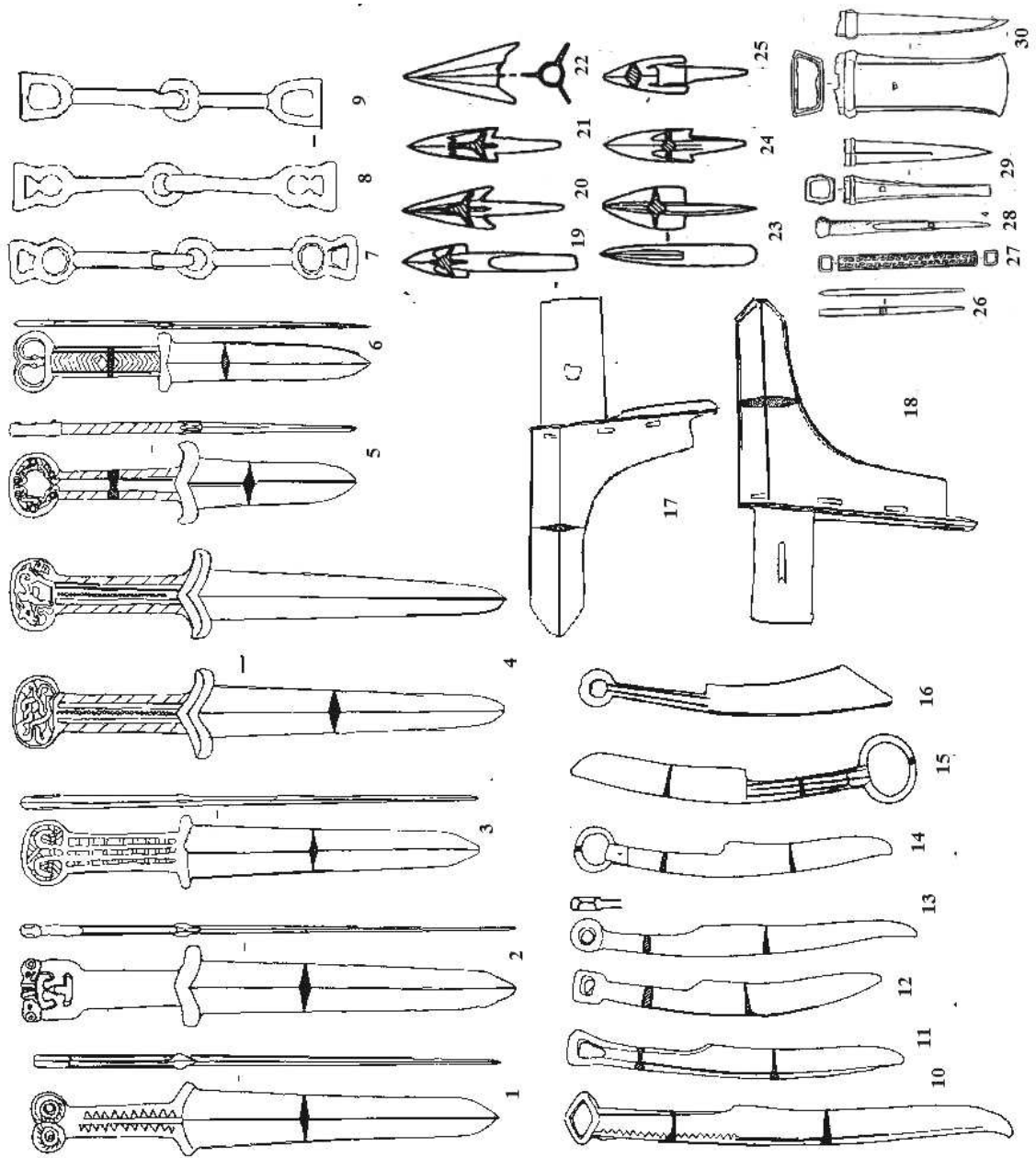


Fig. 129a. Yuhuangmiao cemetery, bronze objects (after Jin F. Y. 2001, 204 Fig. 3, 1-6; 207 Fig. 5, 1-3; 205 Fig. 4, 1-7; 208 Fig. 6, 1-2; BWS 1989, 28 Fig. 18 1-7; 30 Fig. 22, 1-2.4-6).

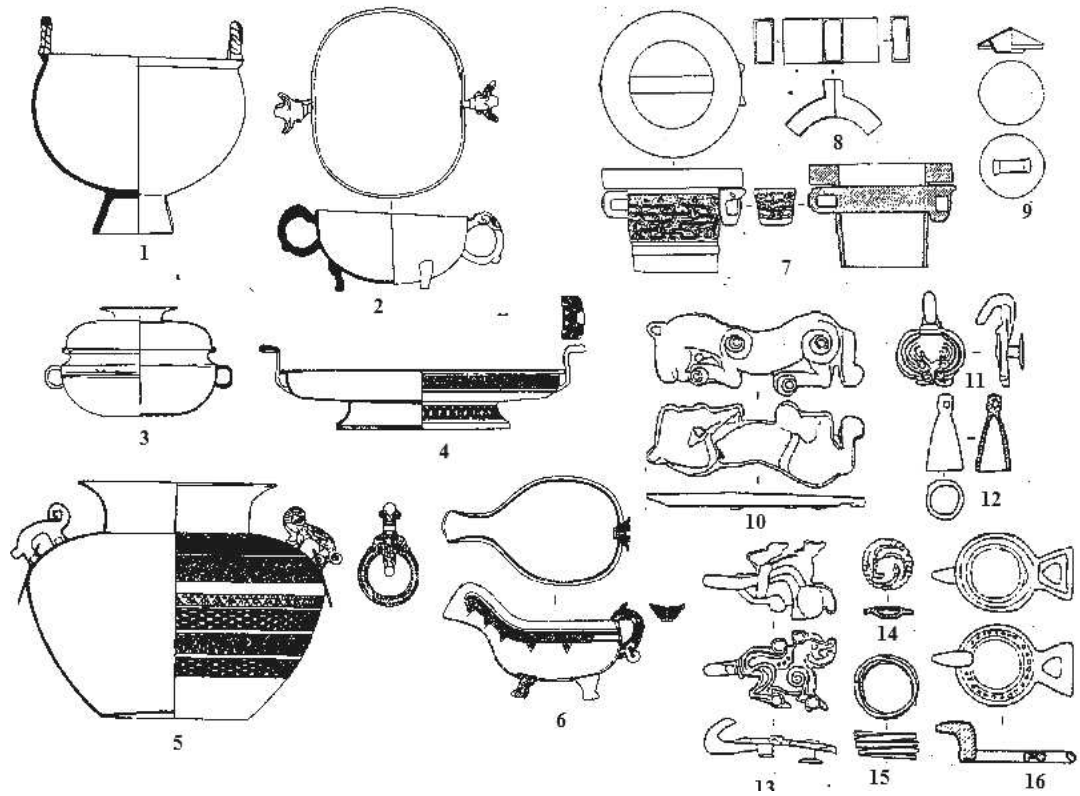


Fig. 129b. Yuhuangmiao cemetery, bronze objects (after Jin F. Y. 2001, 203 Fig. 2, 1-6; BWS 1989, 31 Fig. 25, 2-4; 31 Fig 24, 1-7).

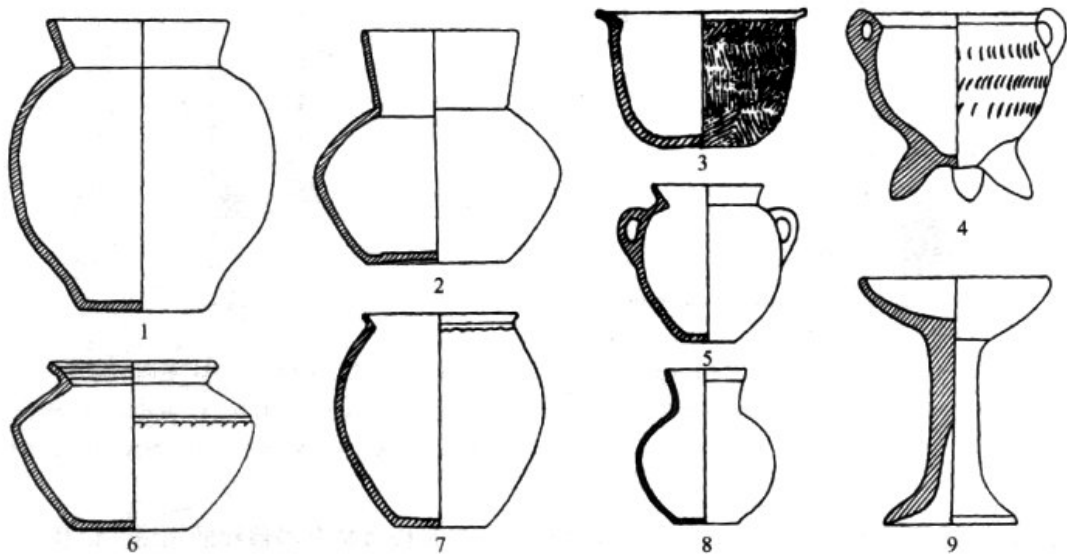


Fig. 130a. Yuhuangmiao culture, potteries, 1.2.6 Yuhuangmiao; 3.5.7 Lishugoumen; 8 Xiaobaiyang; 4.9 Hulugou (after Beifangcaoyuan 2007, 284 Fig. 130).

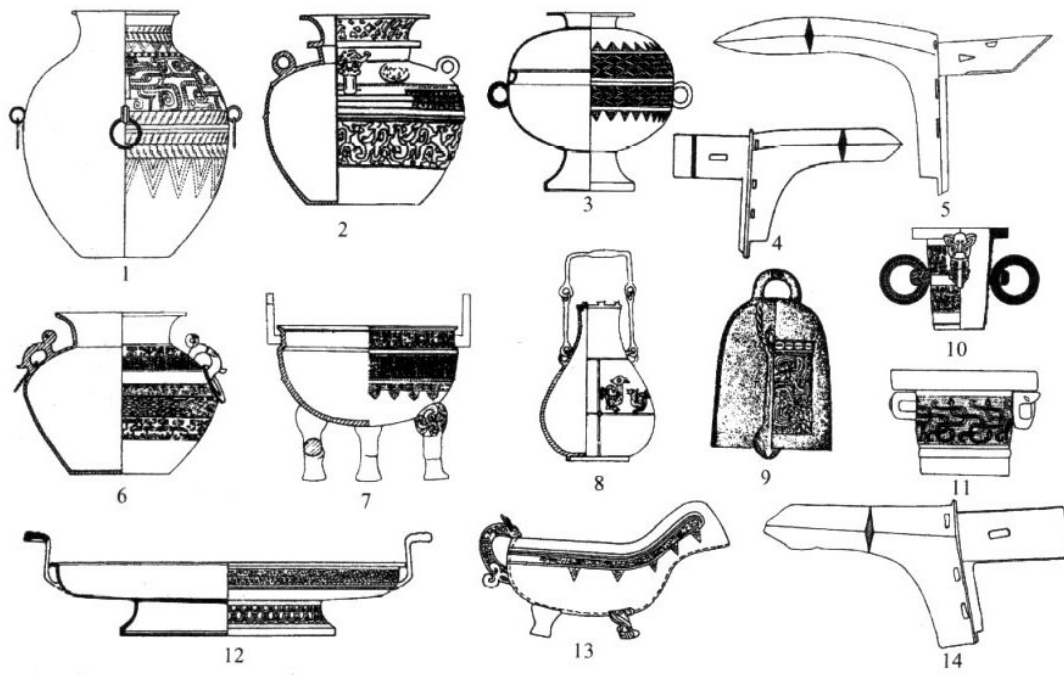


Fig. 130b. Yuhuangmiao culture, bronze objects in the Central Plains style, 1.5.10 Beixinbao; 2.4.6.7.8 Ganzibao; 3.11-14 Yuhuangmiao; 9 Paotashan (after Beifangcaoyuan 2007, 294 Fig. 135).

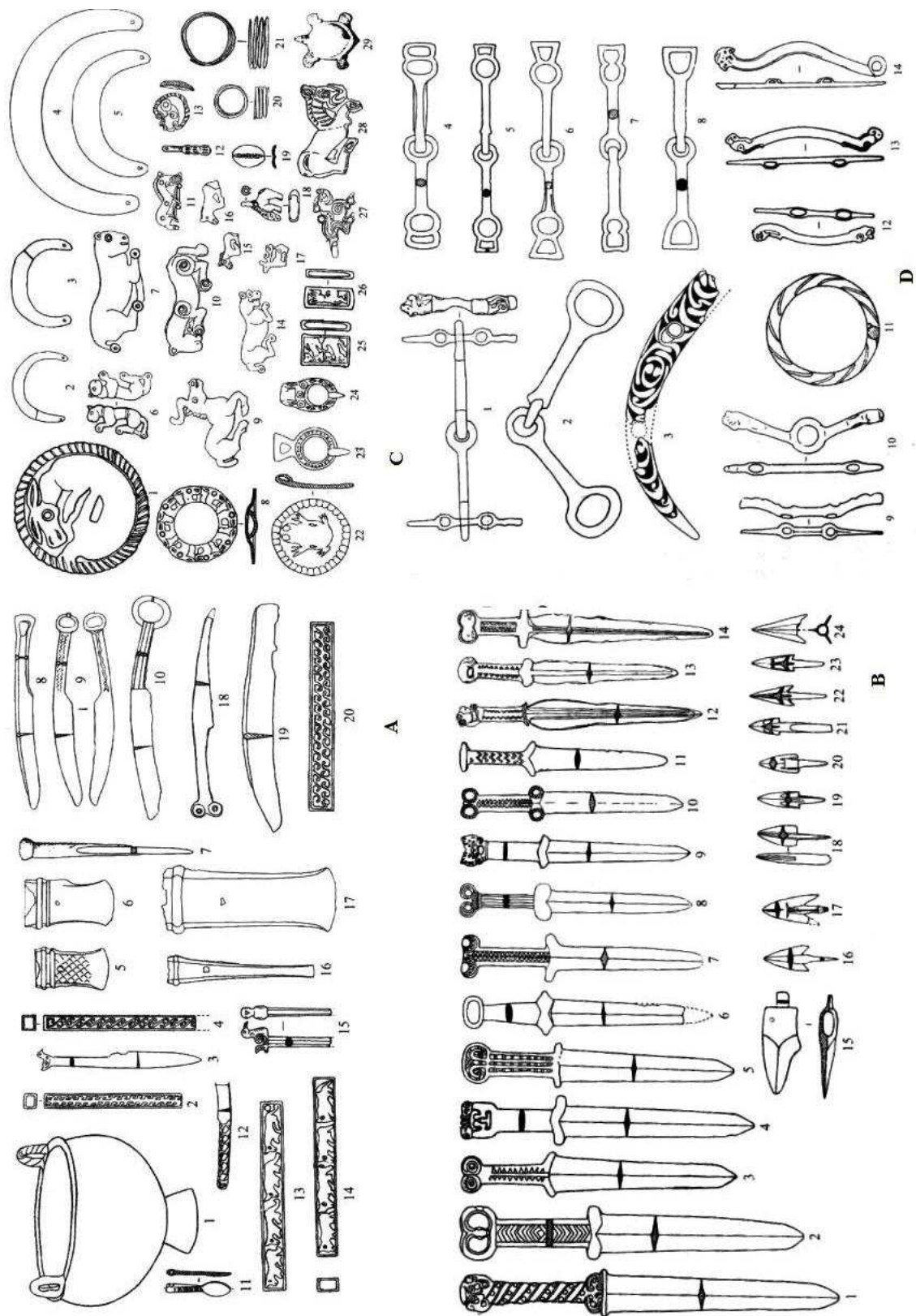


Fig. 130c. Yuhuangmiao culture, metal objects: A vessels and tools; B weapons; C ornaments; D horse fittings C 2-6.14.28, gold; others, bronze (after Beifangcaoyuan 2007, 285 Fig. 131; 286 Fig. 132; 287 Fig. 133; 288 Fig. 134).

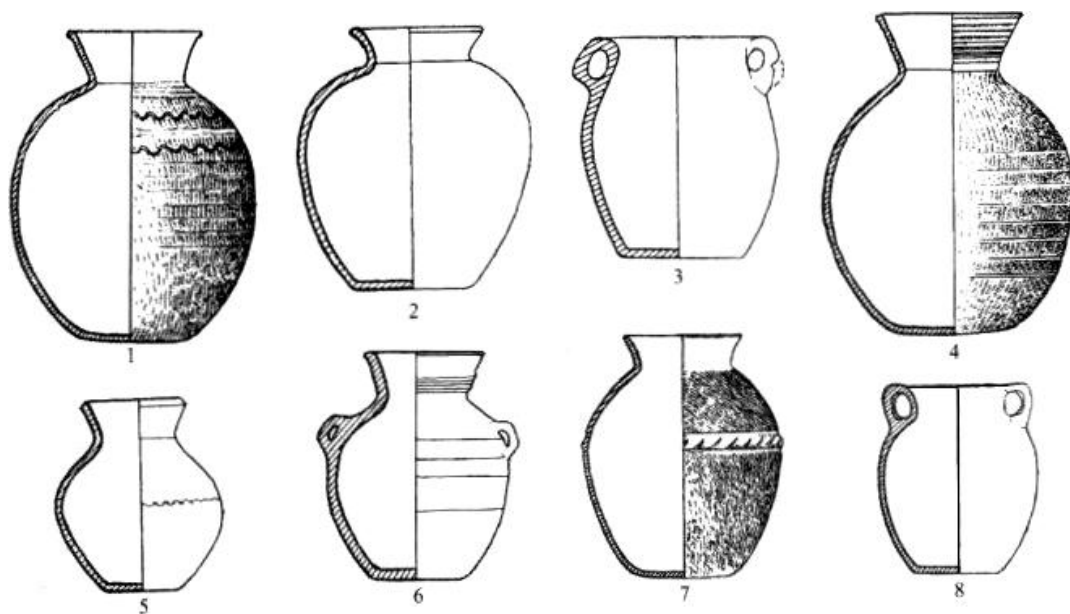


Fig. 131a. Maoqinggou culture, potteries, 1-6 Maoqinggou; 7-8 Guoxianyaozi (after Beifangcaoyuan 2007, 307 Fig. 140).

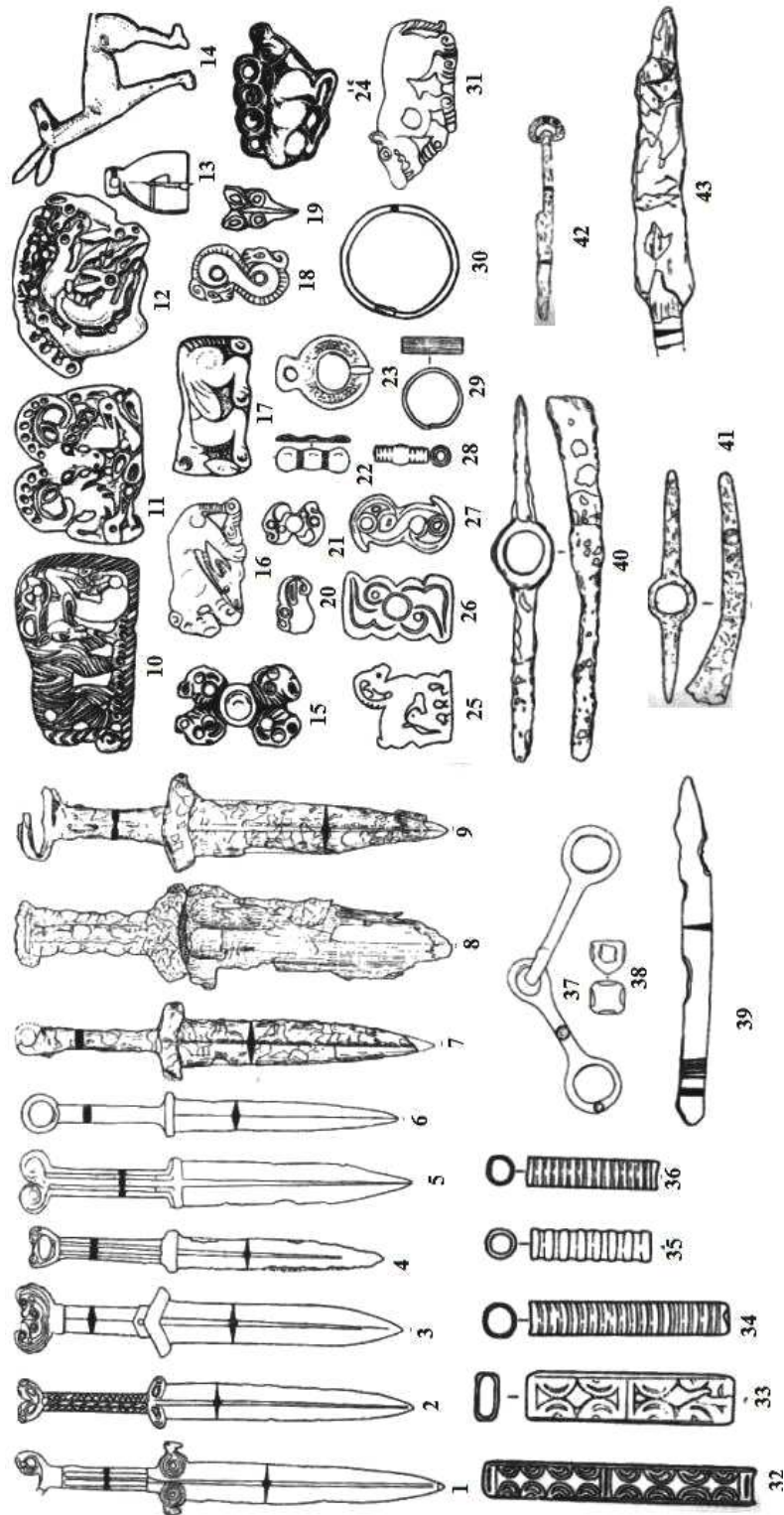


Fig. 131b. Maoqinggou culture, metal objects: 1-9.15.18-20.26.27.31-40.43 Maoqinggou; 10. 13.16.20-23.28-30 Gaouxianyaozi; 11 stored in Inner Mongolia Musuem; 12 Liangcheng; 17 Fanjiayaozi; 24 Huhehaote; 14 Shuijiangoumen; 41.42 Yinniugou; 7-9.40-43 iron, objects; others, bronze (after Beifangcaoyuan 2007, 308 Fig. 141, 1-9; 313 Fig. 145, 1-22; 309 Fig. 142, 1-5.7.8.13.6.9.10.12).

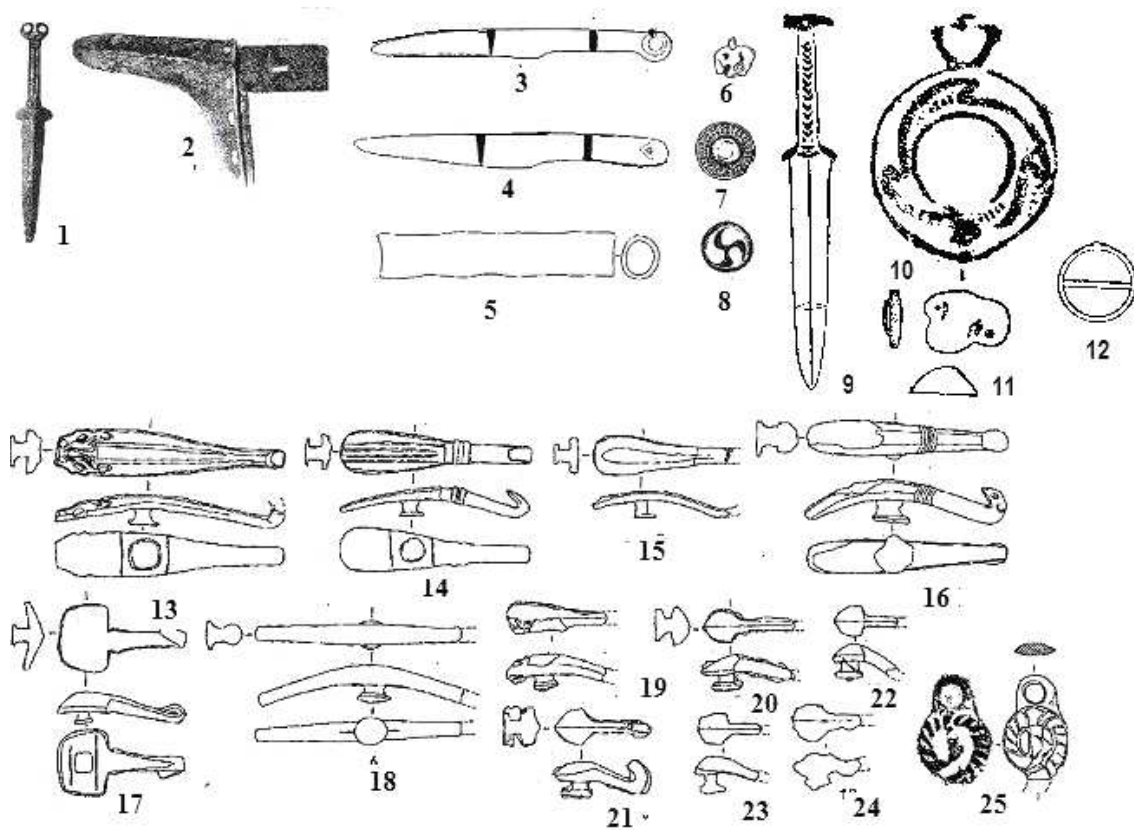


Fig. 131c. Maoqinggou culture, metal objects, 1-2 Fanjiayaozi; 3-8 Shuijiangoumen; 9-12 Goulitou; 13-25 Yinniugou—19-24, iron; others, bronze (after Fig. 093, 32.33; Fig. 097, 2-12; Fig. 084d, 1-13)

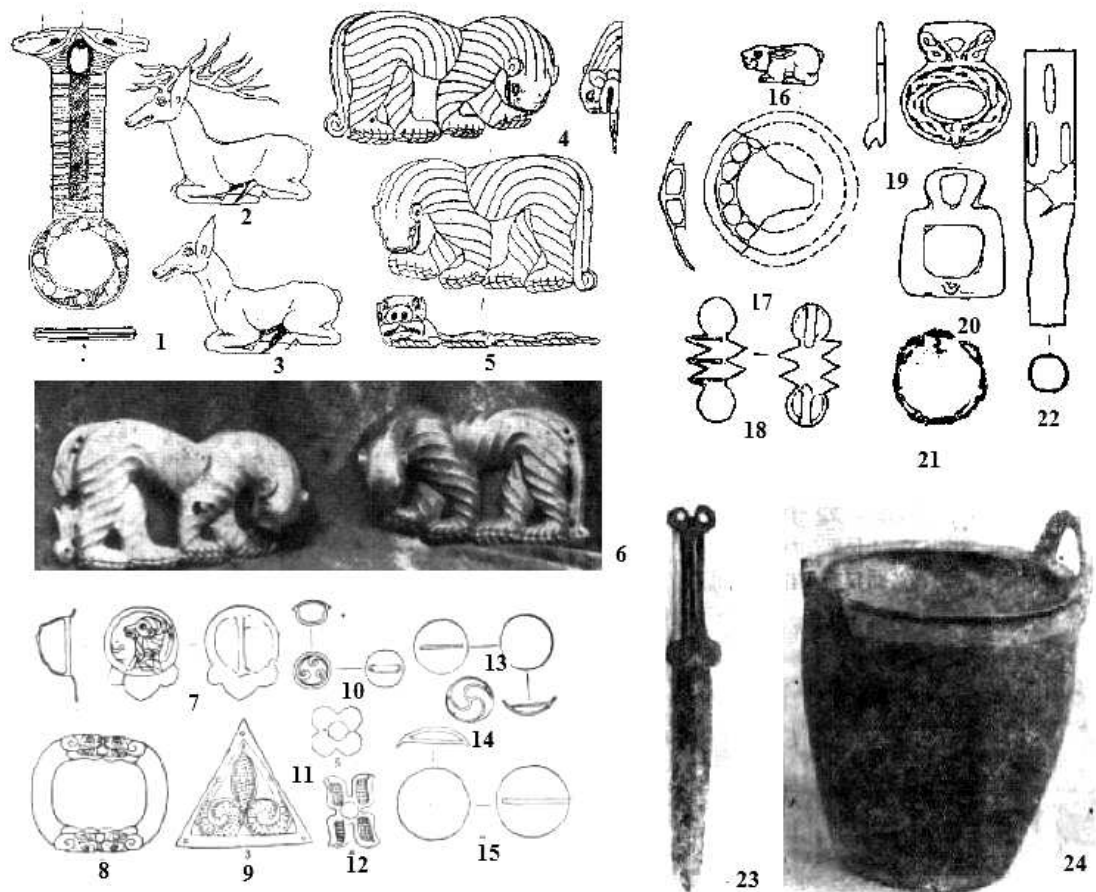


Fig. 132. Metal objects, 1-15 Nalingaotu; 16-22 Lijiapan; 23 Laolongchi; 24 Majiagaigou-1 iron handle; 3.6-9.11.12.14 silver; 4-5 gold; 10.13.15-24 bronze (after Dai/Sun 1983, 24 Fig. 2, 1-5; 29 Fig. 11; 25 Fig. 4, 1-9; 26 Fig. 5, 1-7, Fig. 6, Fig. 7).

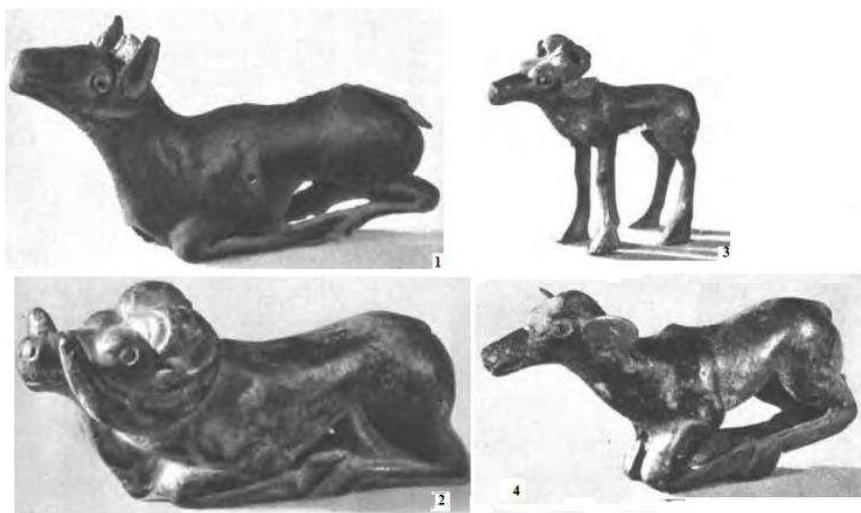


Fig. 133. Waertugou, bronze figures (after NMGXJ 63, 54 Fig. 80, Fig. 81; 55 Fig. 82, Fig. 83).

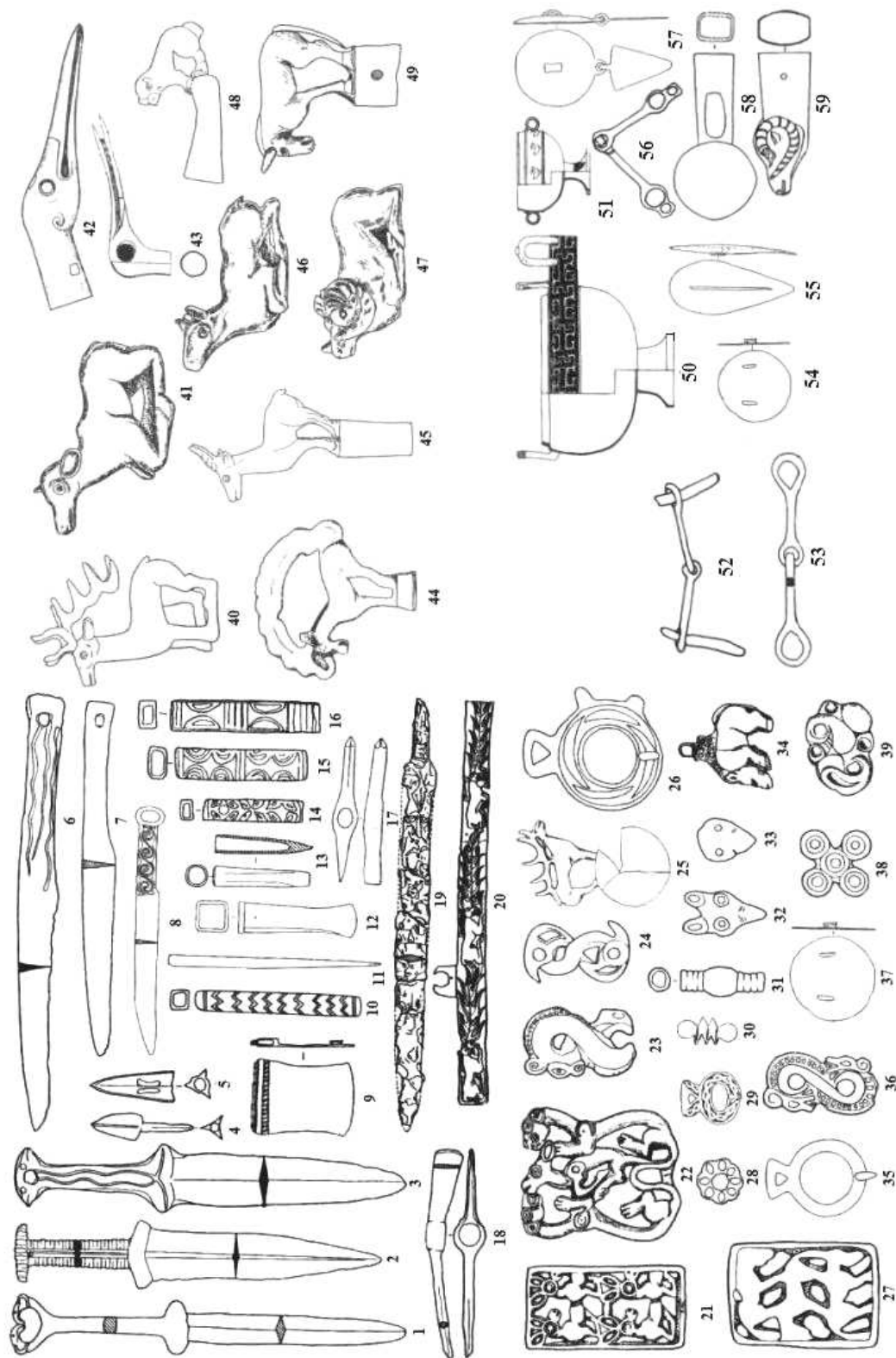
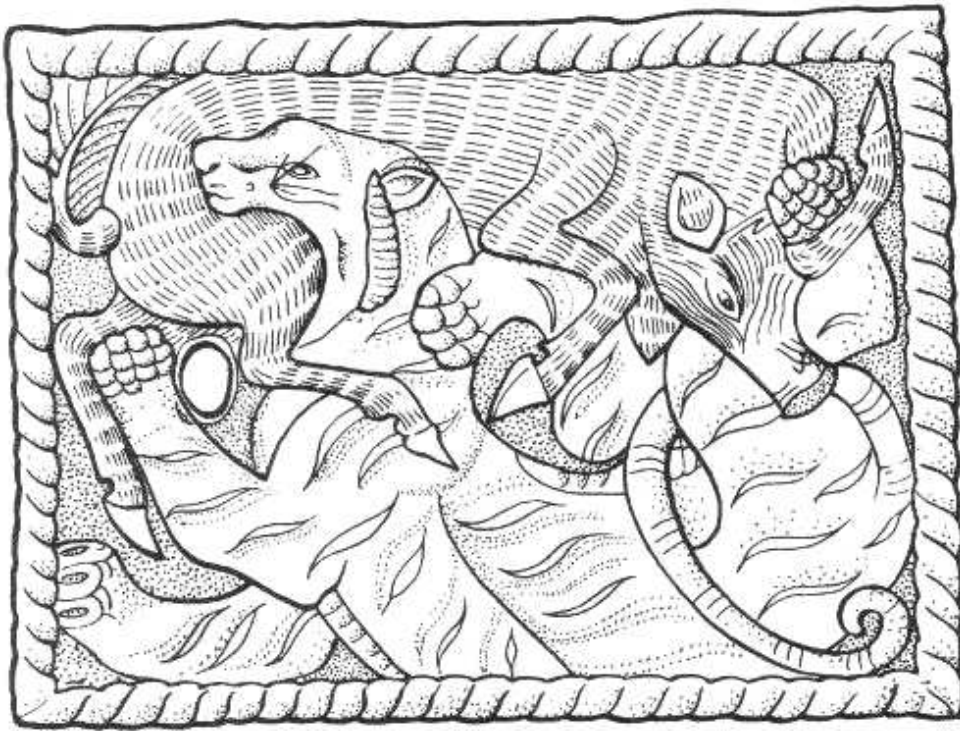
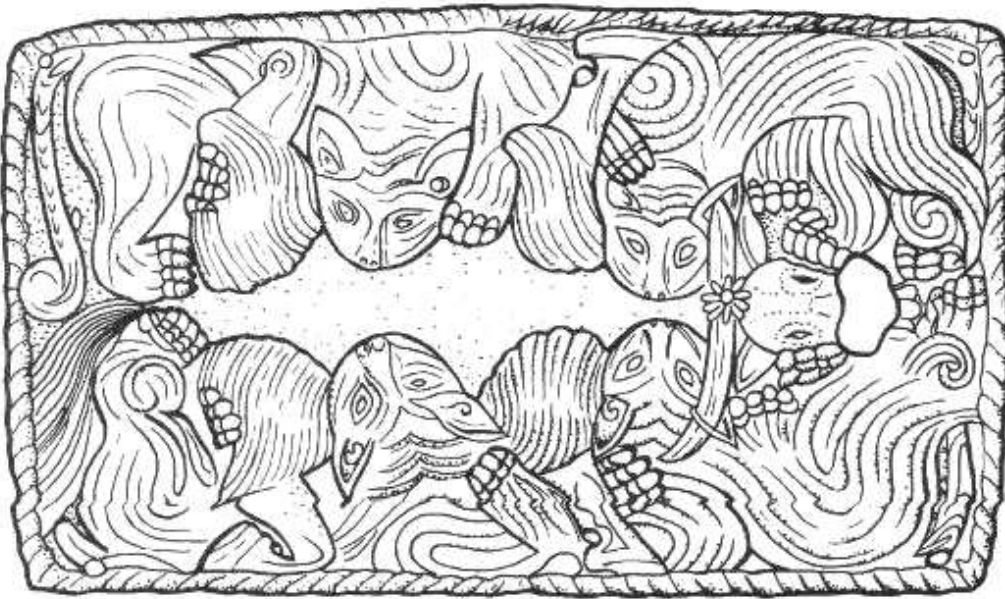


Fig. 134a. Taohongbala culture, metal objects, 19 iron; others, bronze - 1.13.17.55 Gongsuhao; 7.9-11.14-16.23.24.26-28.31-33.37.38.52.54.57 Taohongbala; 2. 25 Hulusitai; 3-6.20.39.42. 44 Xigoupan; 8.12.29.50.51 Baohaishe; 18.49 Yulongtai; 21.22. 34.36.56 Yikezhaomeng; 30.35 Lijiapan; 40.43 Sujigou; 41.45.46 Waertugou; 53.58.59 Shihuigou (after Beifangcaoyuan 2007, 328 Fig. 147, 1-20; 330 Fig. 148, 1-19; 331 Fig. 149, 1-10; 338 Fig. 154, 3-12).



1



2

Fig. 134b. Taohongbala culture, gold belt ornaments, 1 Xigoupan; 2 Aluchaideng (after Beifangcaoyuan 2007, 333 Fig. 151, 1.2).

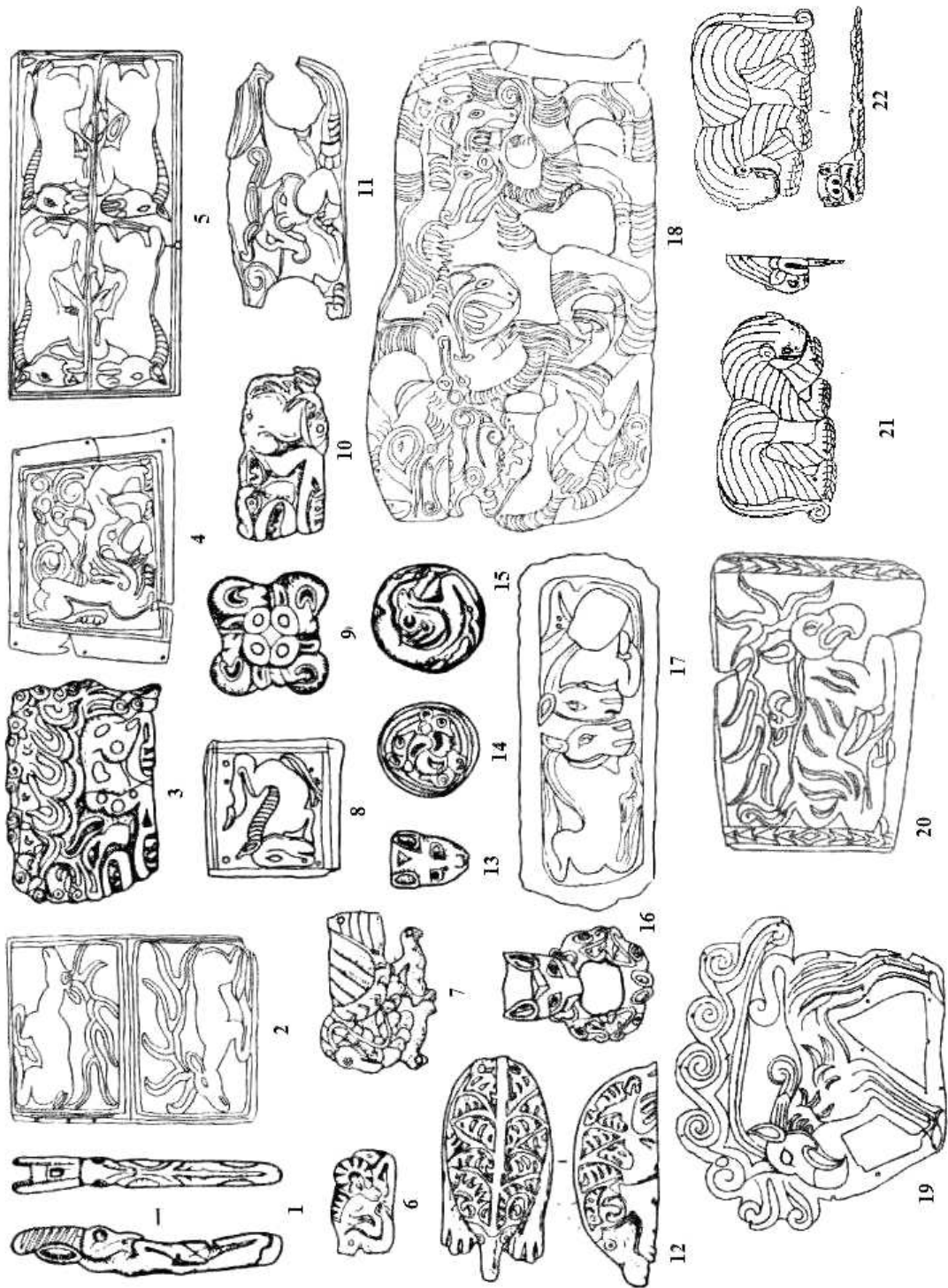


Fig. 134c. Taohongbala culture, gold ornaments - 1.3.6.7.9.12-16 Aluchaideng; 2.4.5.8.11.17.19.20 Xigoupan; 18 Nianfangqu; 21.22 Nalingaotu (after Beifangcaoyuan 2007, 334 Fig. 152, 1-18; 340 Fig. 155, 2.6; Dai/Sun 1983, 24 Fig. 2, 4.5).

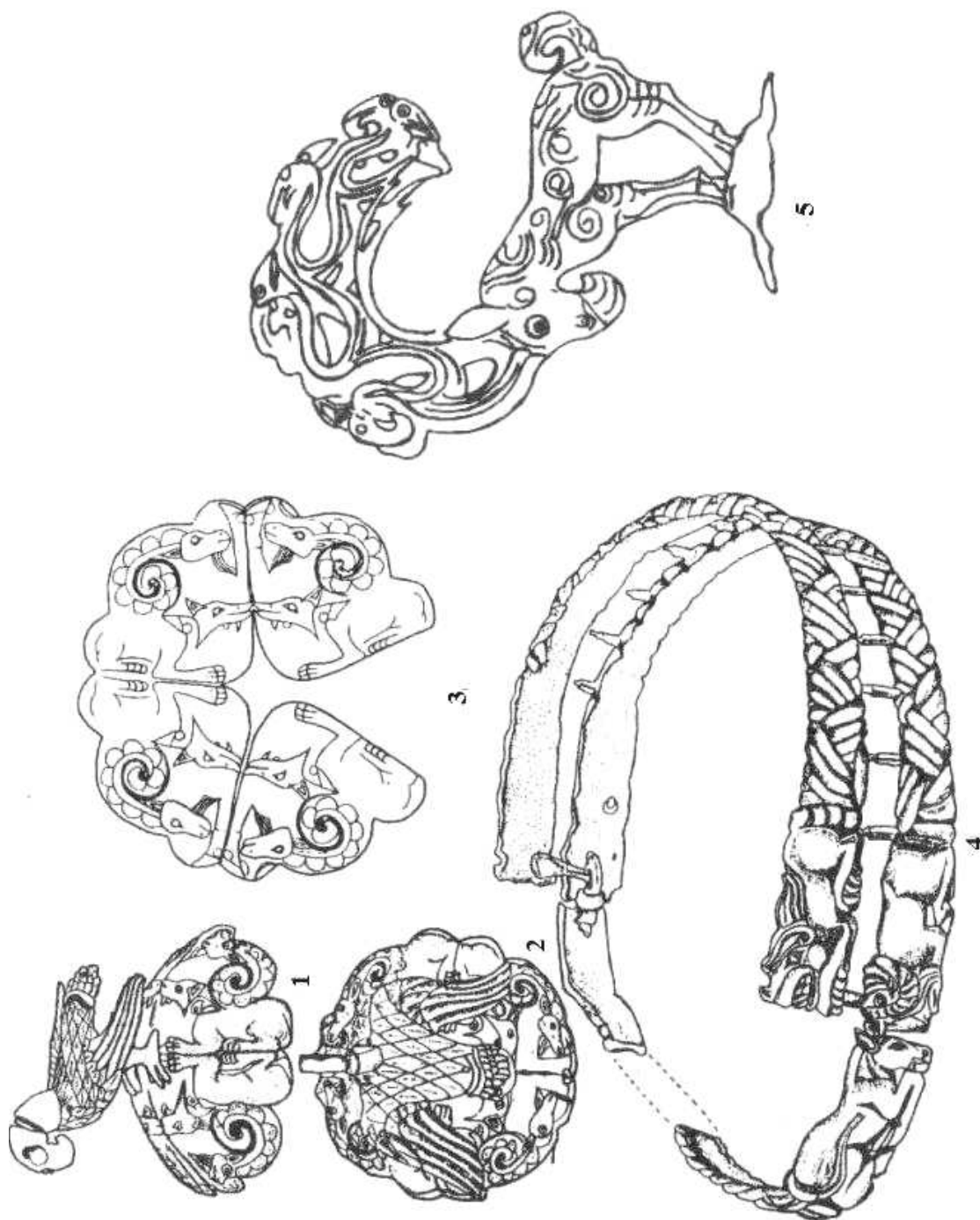


Fig. 134d. Taohongbala culture, gold crown, 1-4 Aluchaideng; 5 Nalingaotu (after Beifangcaoyuan 2007, 332 Fig. 150, 1-4; 340 Fig. 155, 1).

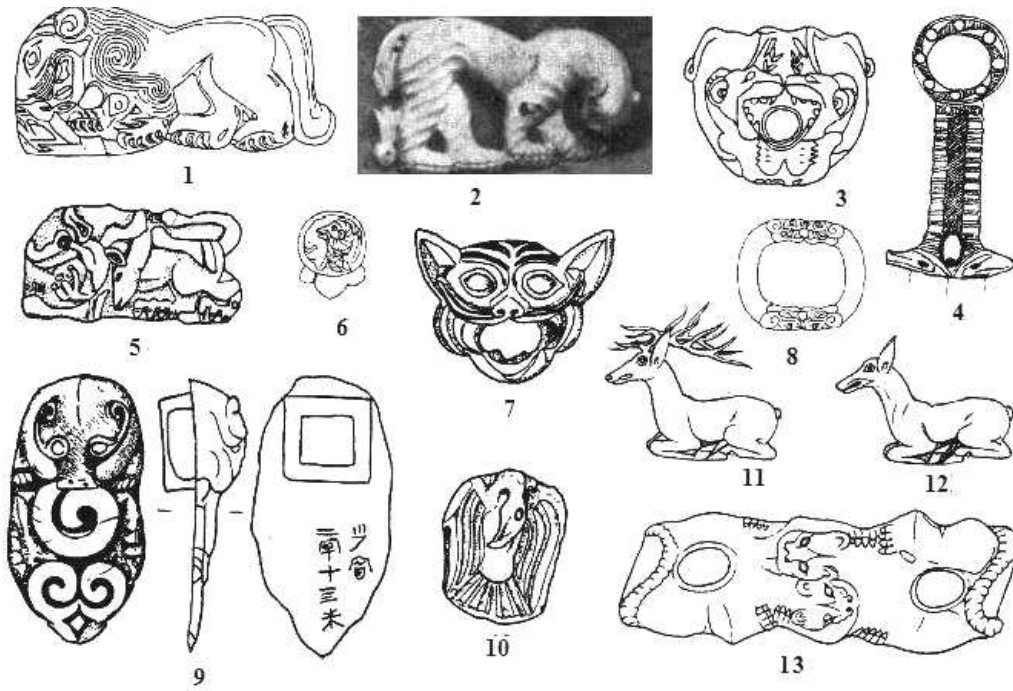


Fig. 134e. Taohongbala culture, silver objects, 1.3.13 Shihuigou; 2.4.6.8.11.12 Nalingaotu; 5.7 Aluchaideng; 9.10 Xigoupan;(after Beifangcaoyuan 2007, 337 Fig. 153, 1; Dai/Sui 1983, 29 Fig. 11; Beifangcaoyuan 2007, 337 Fig. 153, 3-13).

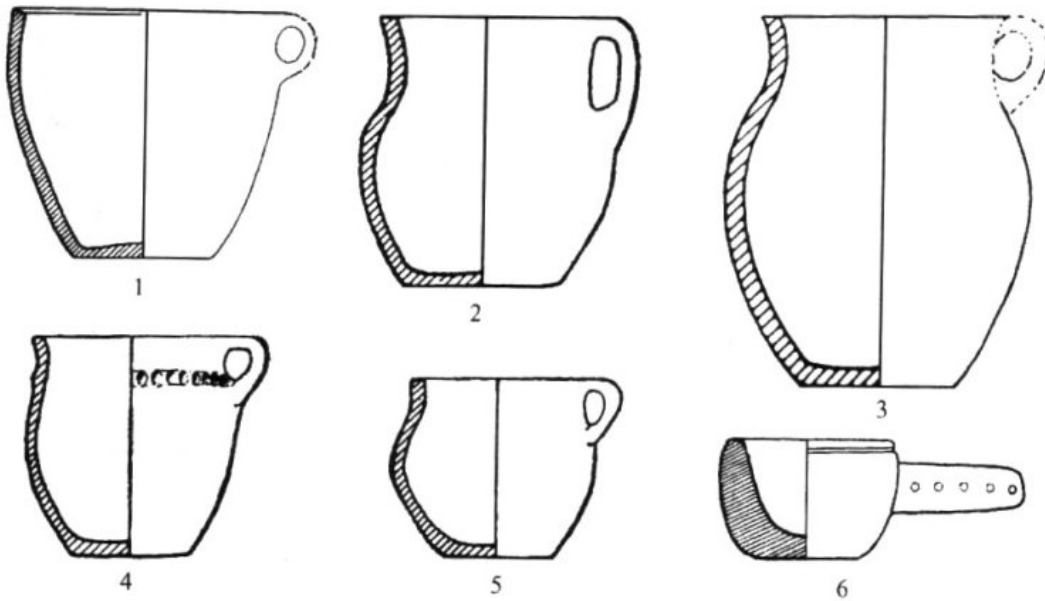


Fig. 135a. Yanglang culture, potteries, 1.6 Niding; 2-5 Yujiazhuang (after Beifangcaoyuan 2007, 366 Fig. 166).

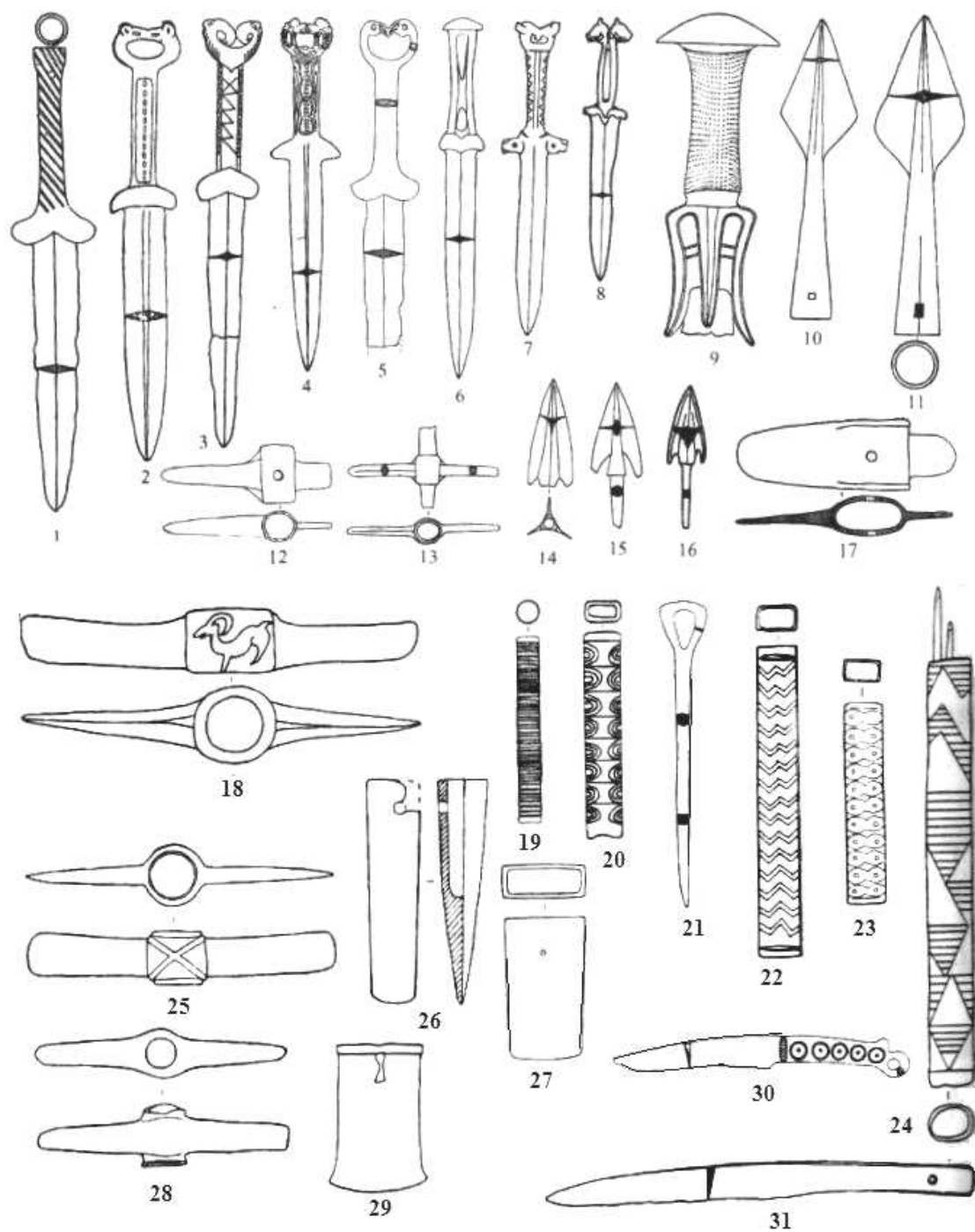


Fig. 135b. Yanglang culture, bronze objects, 1-17 weapons, 18-31 tools, 1 Mazhai; 2.9.10.25.28.29.31 Mazhuang; 3 Ligou; 4.8 Samen; 5 Wangjia; 6.16.21 Xianma; 7 Yangwa; 11.18.20 Miaoqu; 12.13.30 Qin'an; 14.19 Miyuan; 15 Guyuan county; 17 Niding; 22.23.26 Yujiazhuang; 24.27 Zhangjie (after Beifangcaoyuan 2007, 367 Fig. 167,1-17; 369 Fig. 168, Fig. 168, 1-14).

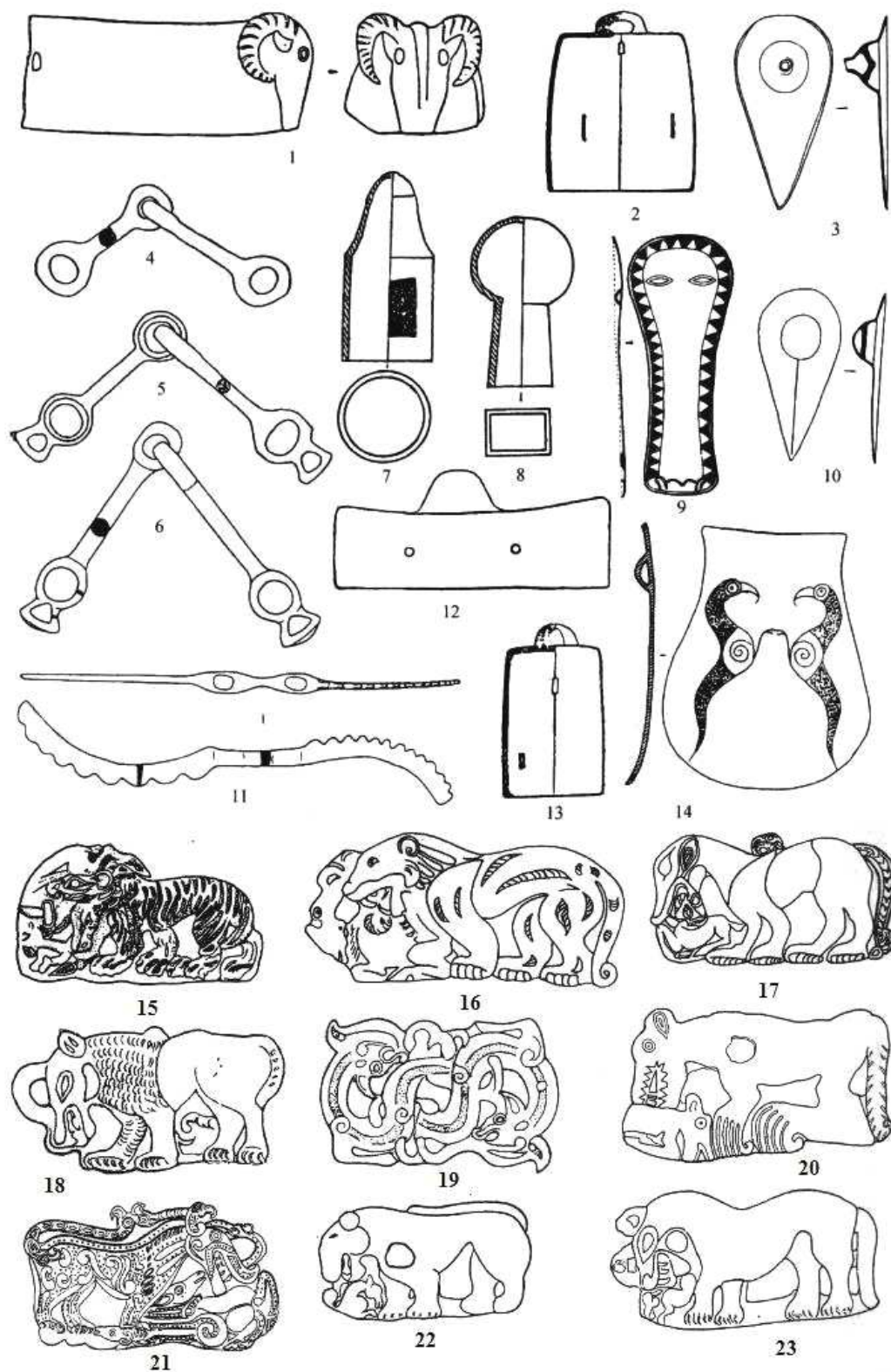


Fig. 135c. Yanglang culture, bronze objects, 1-14 chariot and horse fittings; 15-23 belt ornaments- 1.2.4.5.12.13.15.20.22.23 Mazhuang; 3.10 Zhangjie; 9.14 Niding; 6 Miyuan; 7.8 Yuanjia; 11 Xianma; 16.21 Chenyangchuan; 17 Baiyanglin; 18 Yaohe; 19 Guyuan county (after Beifangcaoyuan 2007, 370 Fig. 169, 1-14; 371 Fig. 170, 1-9).

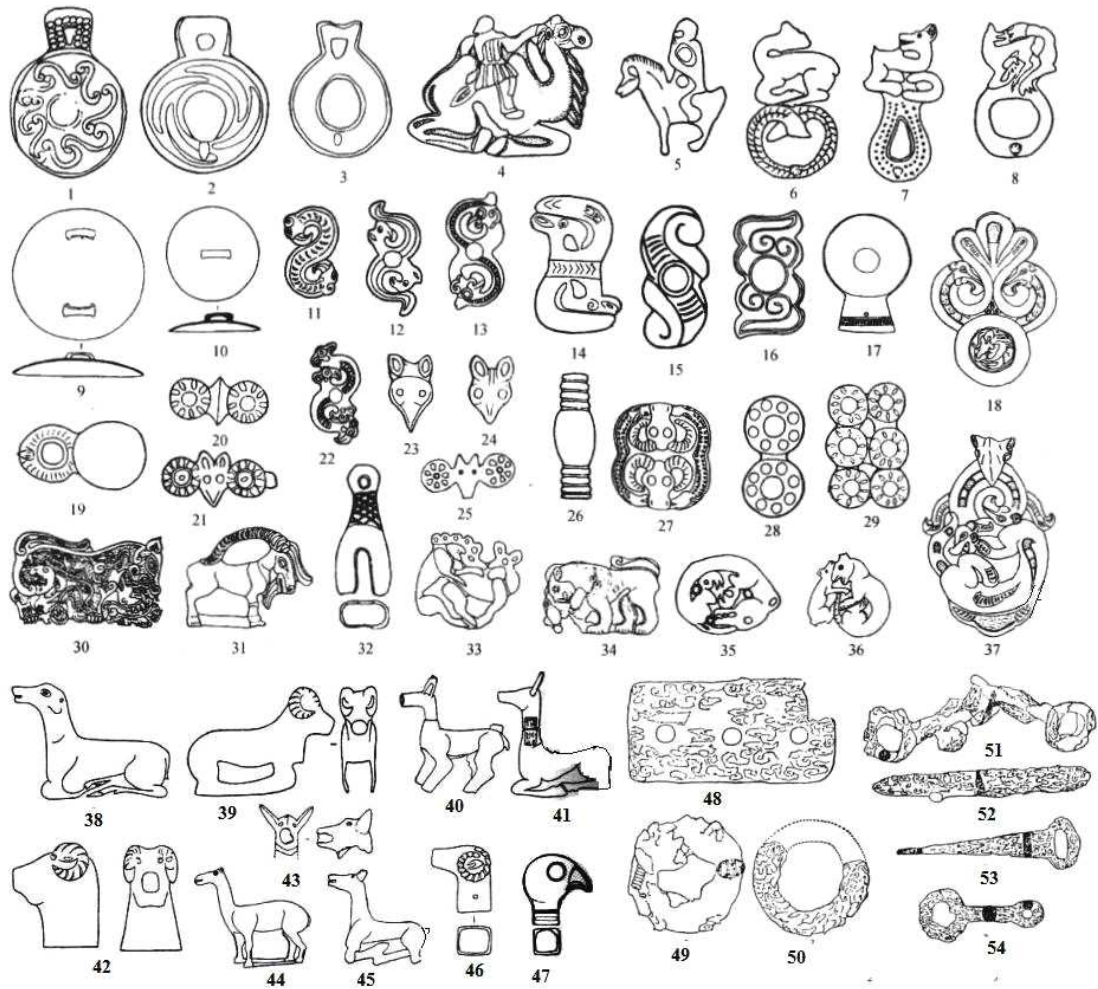


Fig. 135d. Yanglang culture, metal objects, 1-47 bronze; 48-54 iron-1Miaoqu; 2.12.15.29.32.33.47 Yujiashuang; 3.4.13.22 Zhangjie; 6-8.19.27.39.40.41.42.43.45.46.48-54 Mazhuang; 5 Yuqiao in Xijie county; 14.18.37 Chenyangchuan; 30 Tatou; 34 Pengyang county; 35.45 Qin'an county; 36 Wangjiaping; 9.10.28 Miyuan; 11.38 Samen; 16 Guyuan county; 26 Xianma (after Beifangcaoyuan 2007, 372 Fig. 171, 1-37; 377 Fig. 174, 1-10; 374 Fig. 172, 1-7).

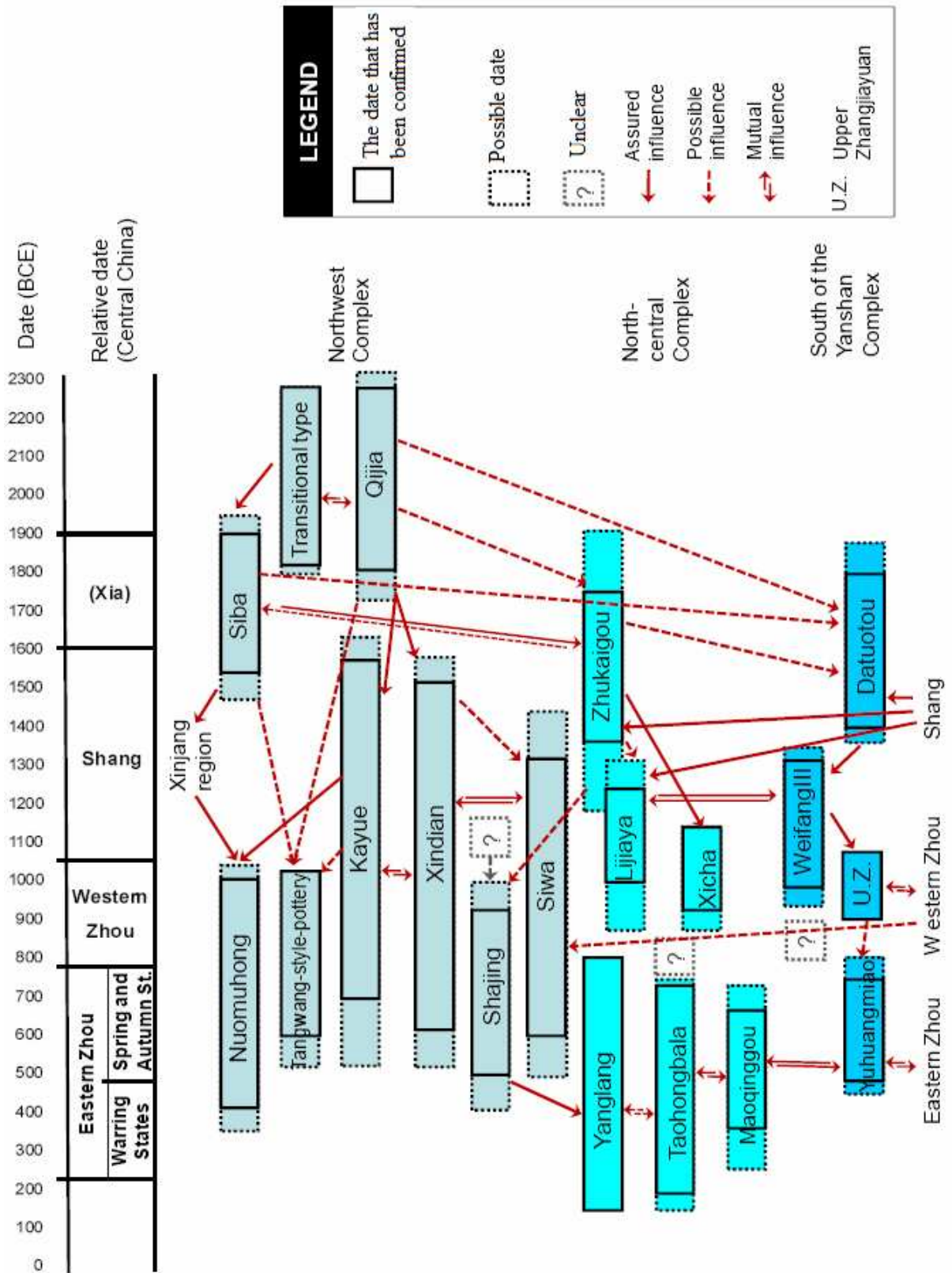


Fig. 136. Chronological and cultural framework of the bronzes in northern China.

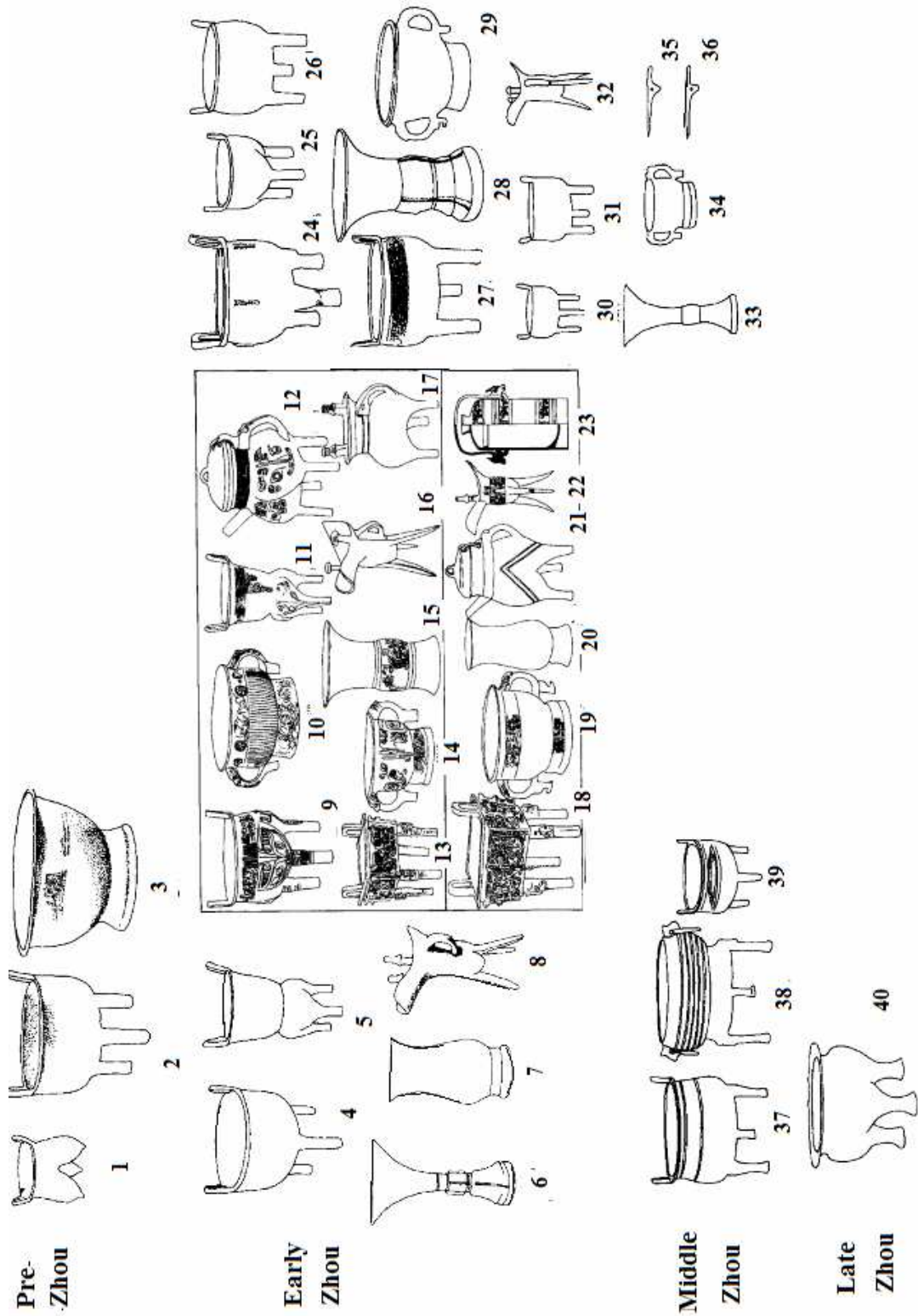


Fig. 137. The bronze objects in the Central Plains style found in Ningxia and east Gansu from the Shang to the Western Zhou period, 1 Suanliping; 2.3 Yujiawan; 4.8 Miaozhuang; 5 Zhifangwan; 6 Jingchuan 7 Pingliang; 9-23 Baicaopo; 24 -29, 37-39 Pingliang region; 30.34-36 Tuergou; 31-33 Miaozui; 40 Xiejia (adapted from Shui T. 2001a, 260 Fig. 42; 261 Fig. 43; 263 Fig. 44; 264 Fig. 45; 267 Fig. 46).

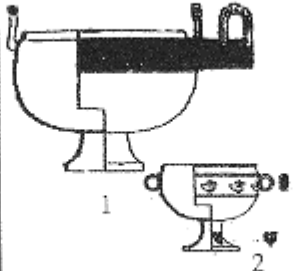
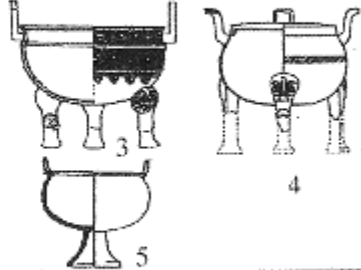



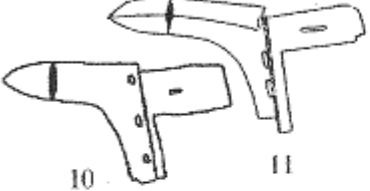
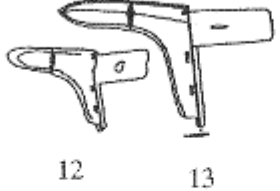
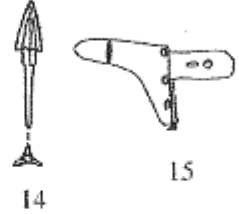
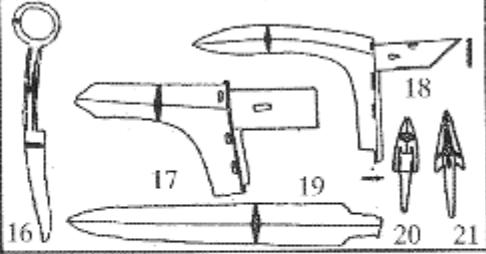
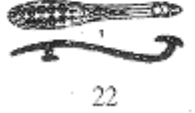

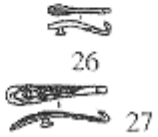
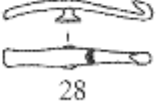
Region type	Guyuan region	Qingyang region	West Inner Mongolia	East Inner Mongolia	north Hebei
ritual vessel					
horse and chariot fitting					
weapon					
ornament					

Fig. 138. The metal objects in the Central Plains style found in northern China during the Spring and Autumn period to the late Warring States (adapted from YJH 2004, 135 Fig. 70).

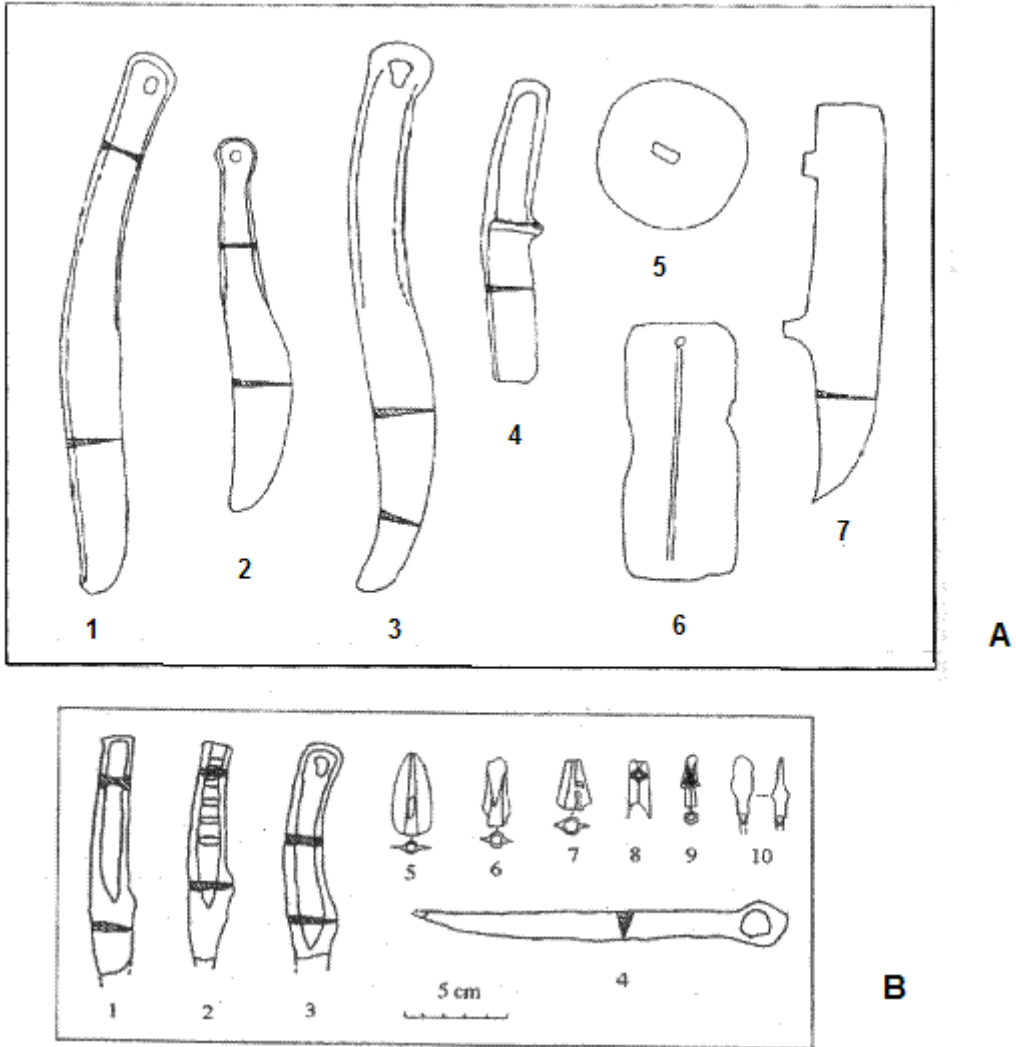


Fig. 139a. Xinjiang, copper and bronze objects: A Tianshanbeilu; B Yanbulake (after MJJ 2000, 89 Fig. 2.10; 90 Fig. 2.13).

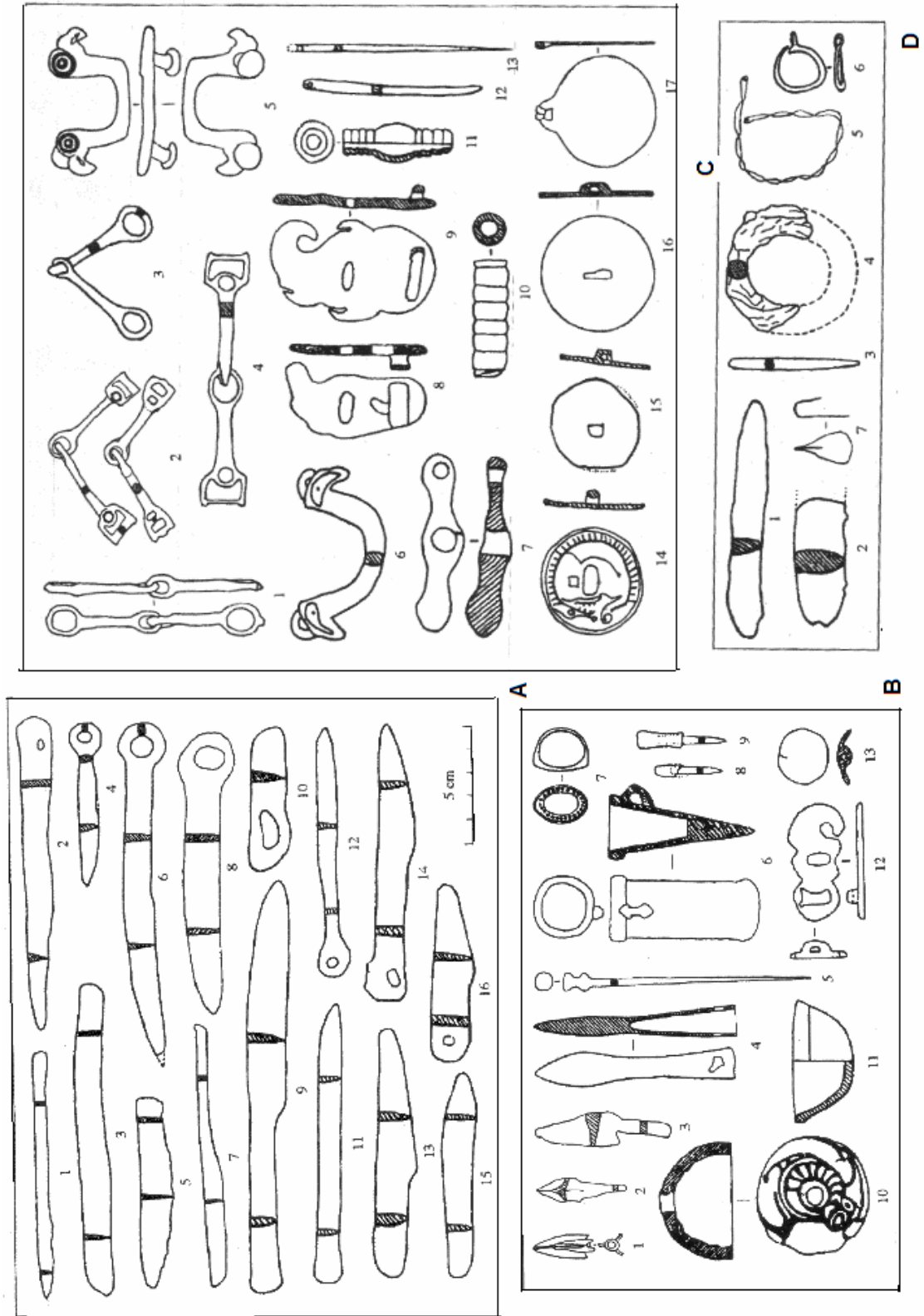


Fig. 139b. Xinjiang, metal objects found in Chawuhugou cemetery: A.B.C copper and iron objects; D iron and gold objects (after MJJ 2000, 99 Fig. 2.31, Fig. 2.32; 100 Fig. 2.33, Fig. 2.34).

新疆地区

欧亚草原

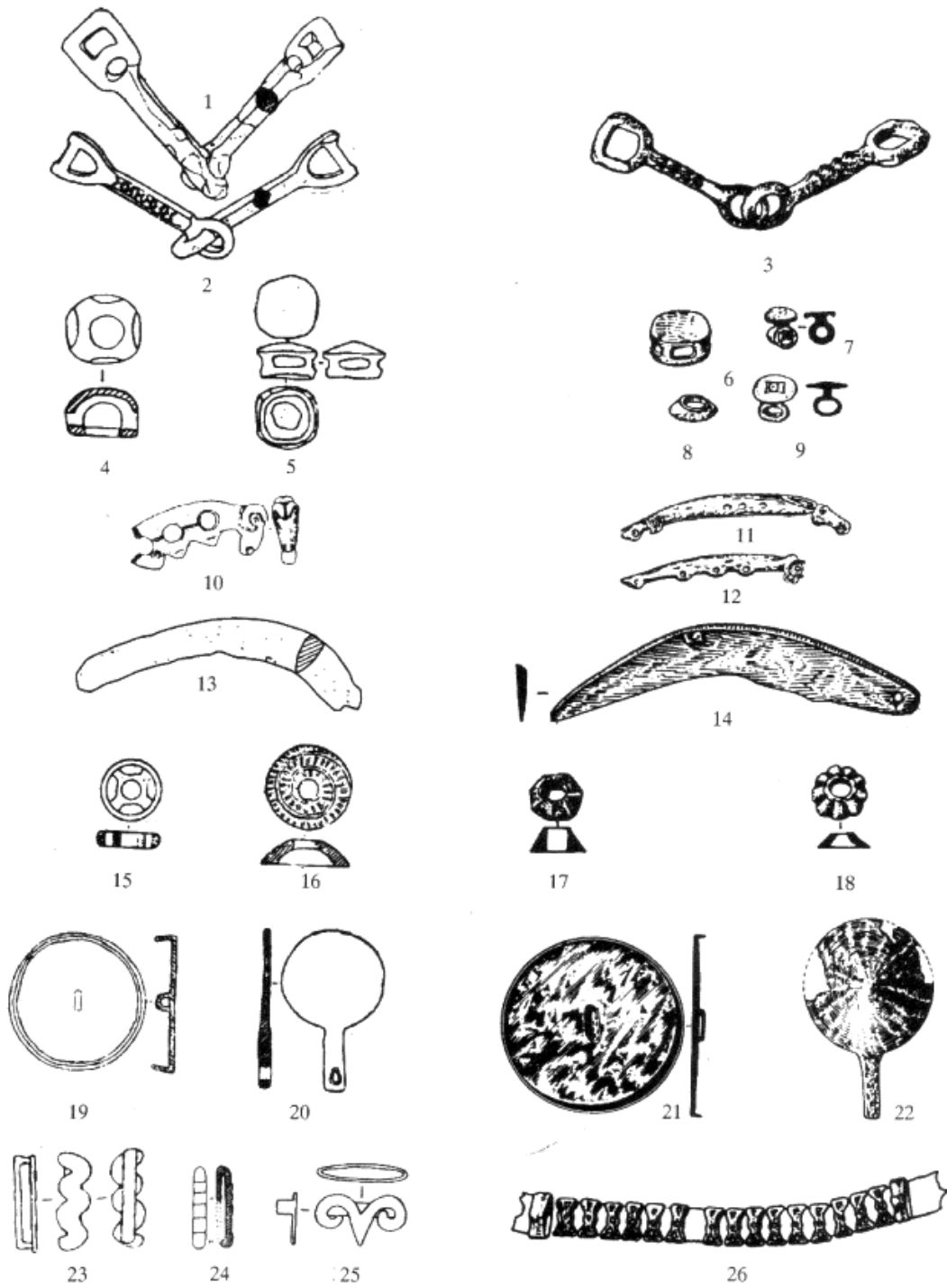


Fig. 140a. Similar metal objects found in Xinjiang and the Eurasian Steppes, 1.3.10.13.14.17.24 Chawuhu; 2.5.15.16.1.20 Qunbake; 23 Banfanggou; 24 Xiangbaobao; 3.6-9.17.18.26 Central Asia; 11.12.22 Black Sea; 14.21 Siberia. Remark: 新疆地区-Xinjiang region; 欧亚草原-Eurasian Steppes (after YJH 2004, 151 Fig. 74).

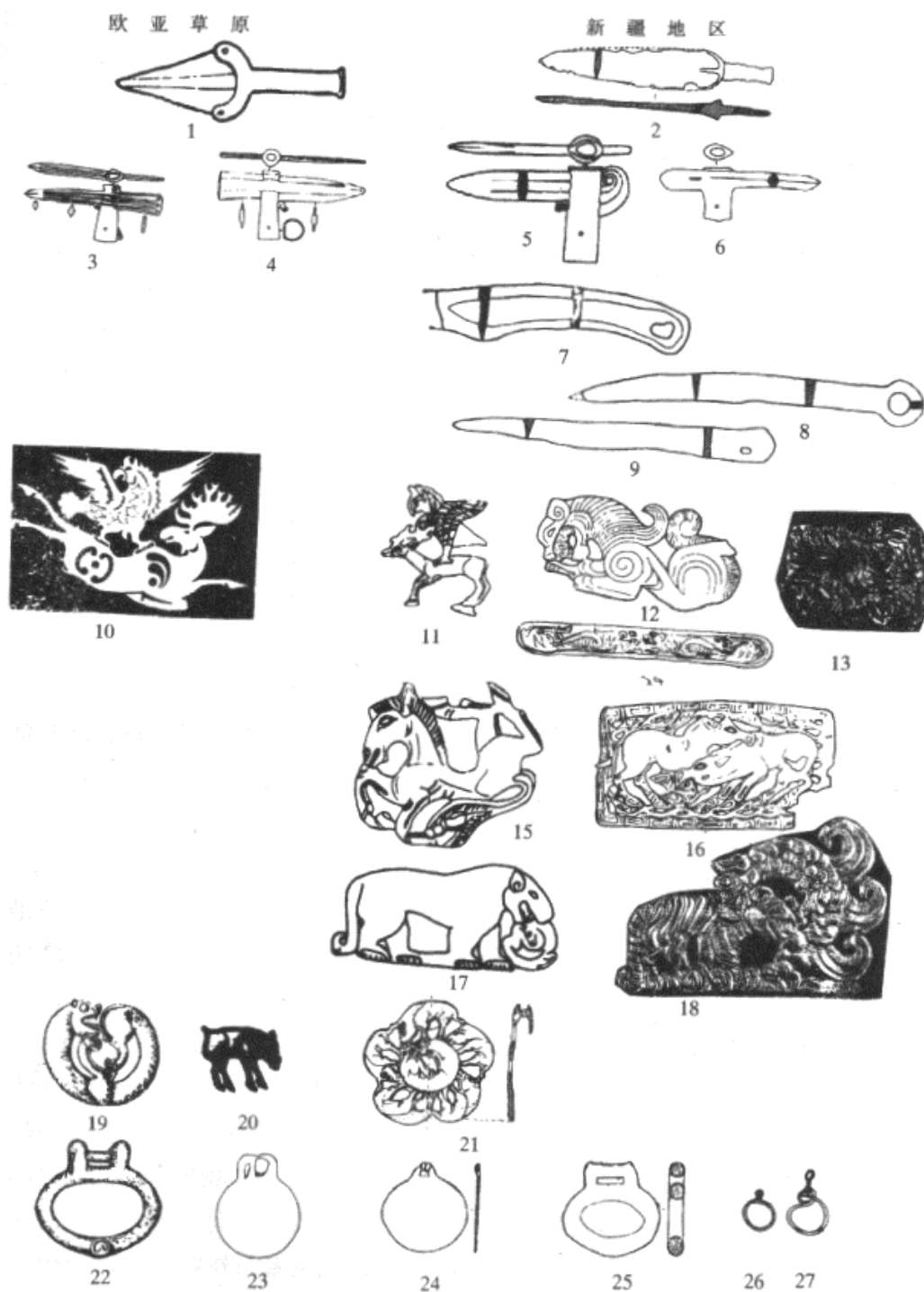


Fig. 140b. Similar metal objects found in Xinjiang, Eurasian Steppes, and northern China, 1.3.4. Siberia; 2 Tianshanbeilu; 5.25 Qunbake; 6 Banfanggou; 7 Yanbulake; 8.9.24 Chawuhu; 10 Altai; 11.15 Ahaqi; 12.14 Alagou; 13.18 Jiaohegucheng; 16.21 Mulei town; 17 Aidinghu; 19.20 Kazakstan; 23 Mongolia; 26.27 Kurlētu, remark: 新疆地区-Xinjiang region; 欧亚草原-Eurasian Steppes (after YJH 2004, 153 Fig. 75).

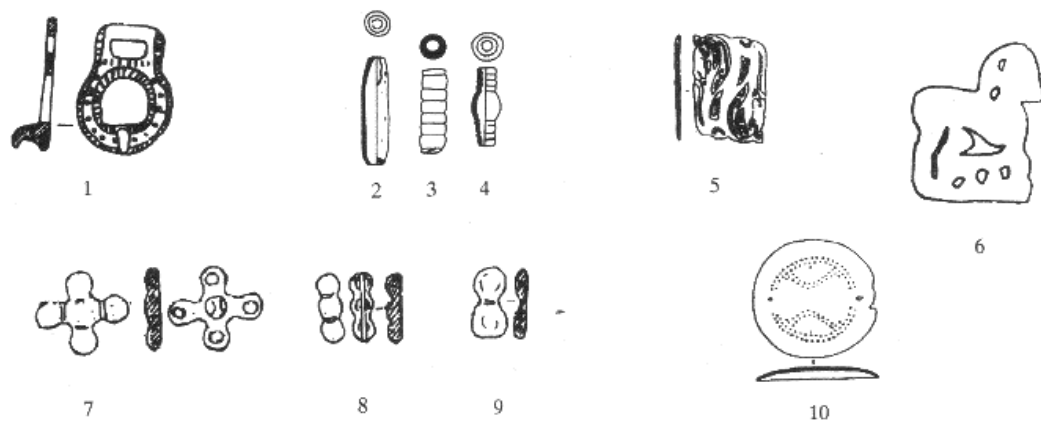


Fig. 140c. Xinjiang, metal objects similar to those in northern China, 1-4.7-9 Chawuhu; 5 Aidinghu; 6 Hanqigou; 10 Yanbulake (after YJH 2004, 155 Fig. 76).

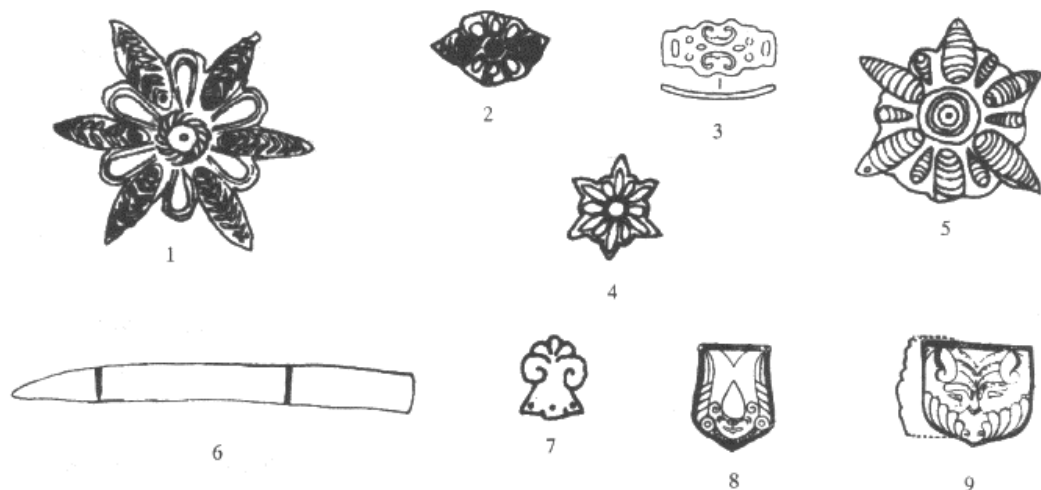


Fig. 140d. Xinjiang, metal objects with local style, 1 Yanghai; 2.4.8.9 Alagou; 3 Xiangbaobao; 5 Aidinghu; 6 Subashen; 7 Ahaqi (after YJH 2004, 156 Fig. 77).

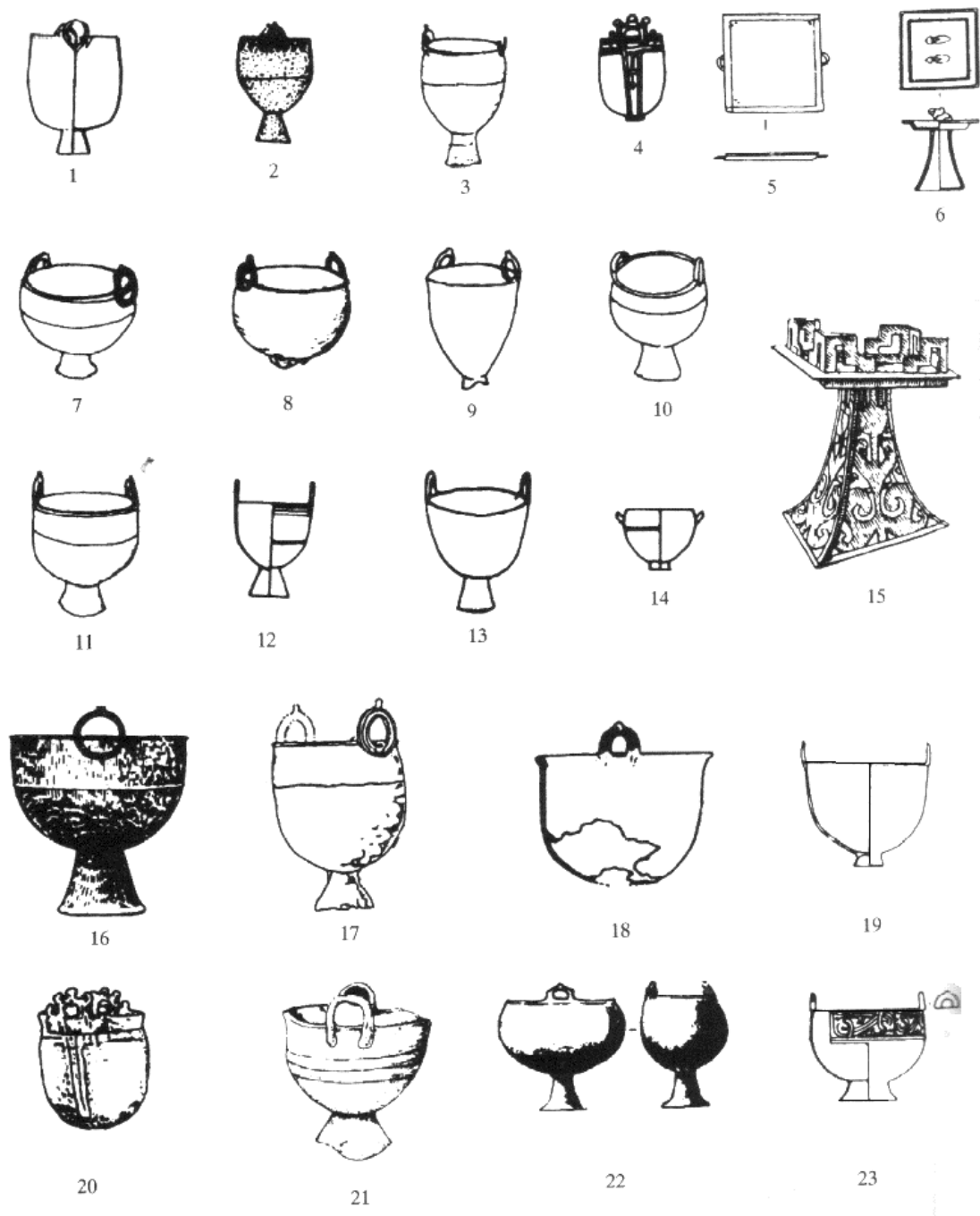


Fig. 140e. Bronze cooking ware-Fu and square plate found in Xinjiang, Eurasian Steppes, and northern China: 1 Huocheng; 2.5 Gongliu 3.7 Eurasian Steppes; 4 Wulumuqi; 5 Alagou; 7 Balikunhongshan; 10 Yili; 11 Qitai; 12 Lanzhouwanzi; 13.14 Balikun; 15 Tianshan; 16 trans-Caucasia; 17 Kazakstan; 18 Yanqing; 19 Qishan; 20 Ural; 21 Siberia; 22 Black Sea; 23 Fengxiang (after YJH 2004, 158 Fig. 78).




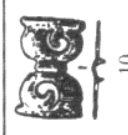


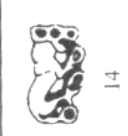

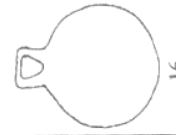
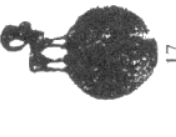
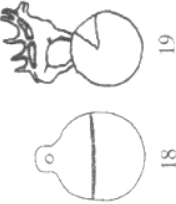
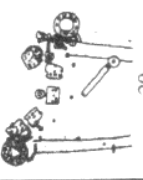

	Altai	Tuva	Siberia/Minusinsk	Mongolia	Northern China
animal patterns					
plaques					
mirror					
belt ornaments					

Fig. 141a. Similar metal objects found in the Eurasian steppes and northern China (adapted from YJH 2004, 145 Fig. 72B).

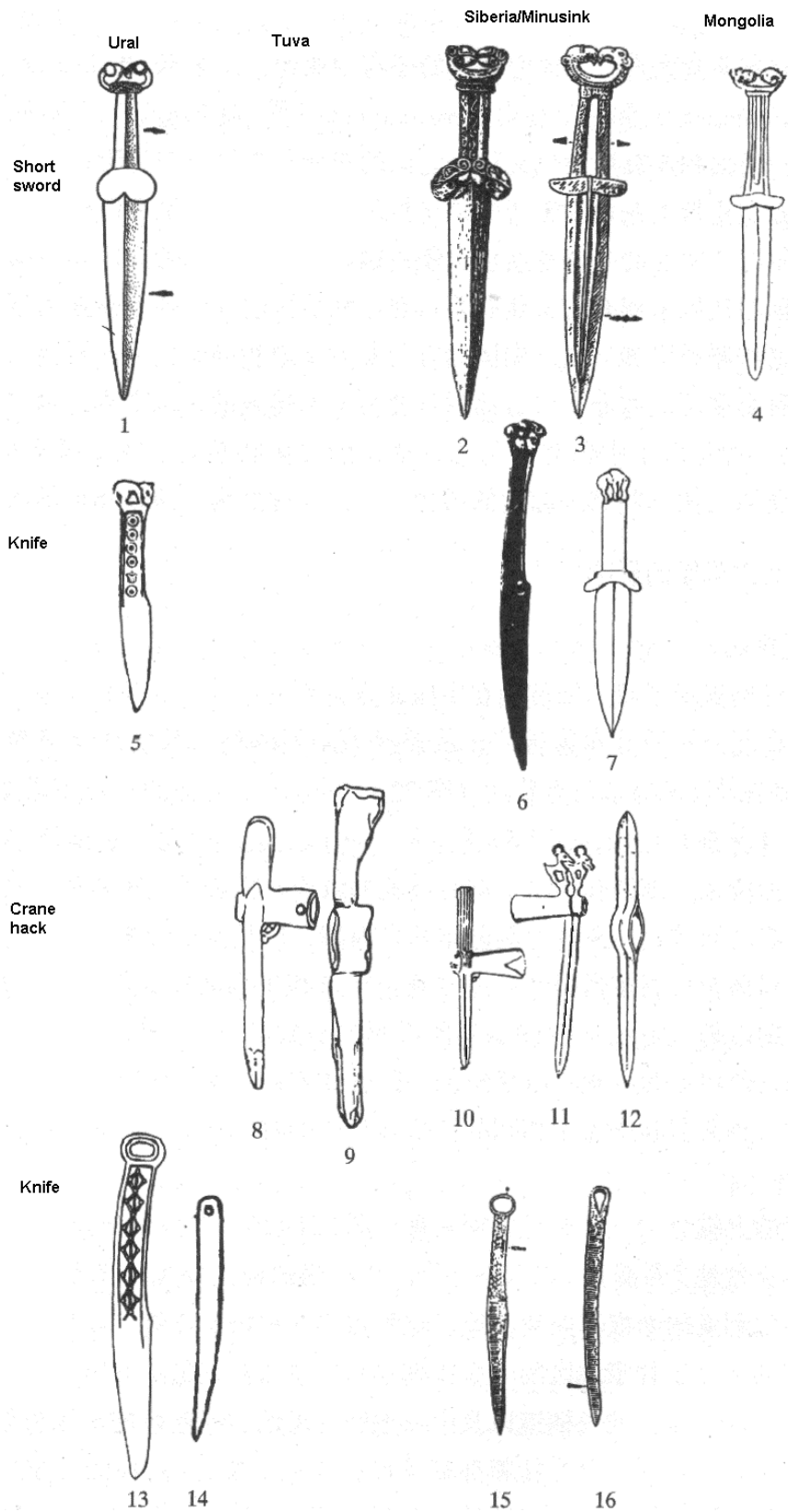


Fig. 141b. Similar metal objects found in the Eurasian Steppes and northern China (adapted from YJH 2004, 144 Fig. 72A).

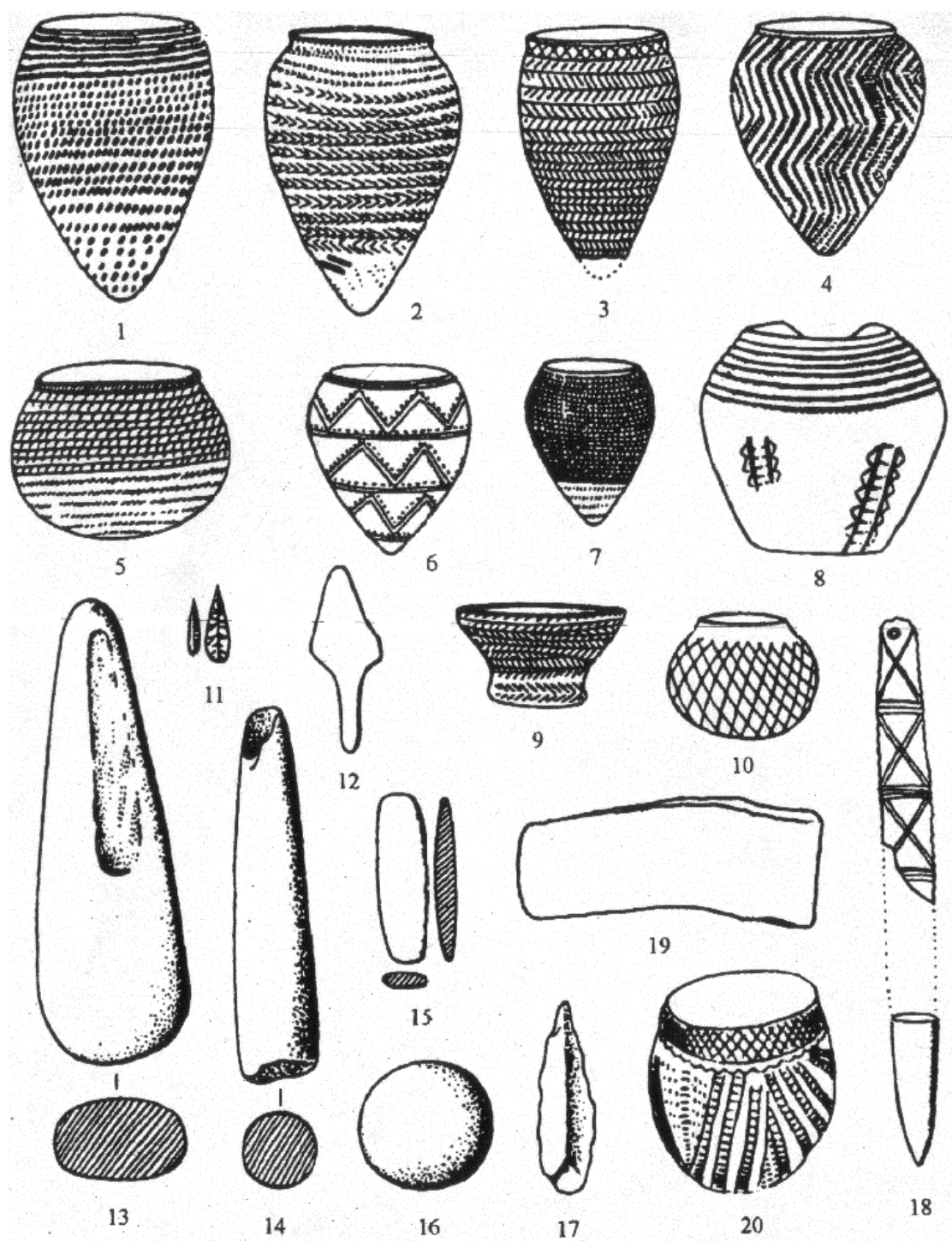


Fig. 142. Funeral objects from Afanasievo graves in southern Siberia and the Afanasievo-related objects from Altai and Xinjiang, 1-18 pottery, stone and bone of Afanasievo culture found in southern Siberia; 19 bronze axe from Altai; 20 pottery jar recovered at Kan'erzi in Qitai, Xinjiang (after MJJ 2000, 164 Fig. 6.1).

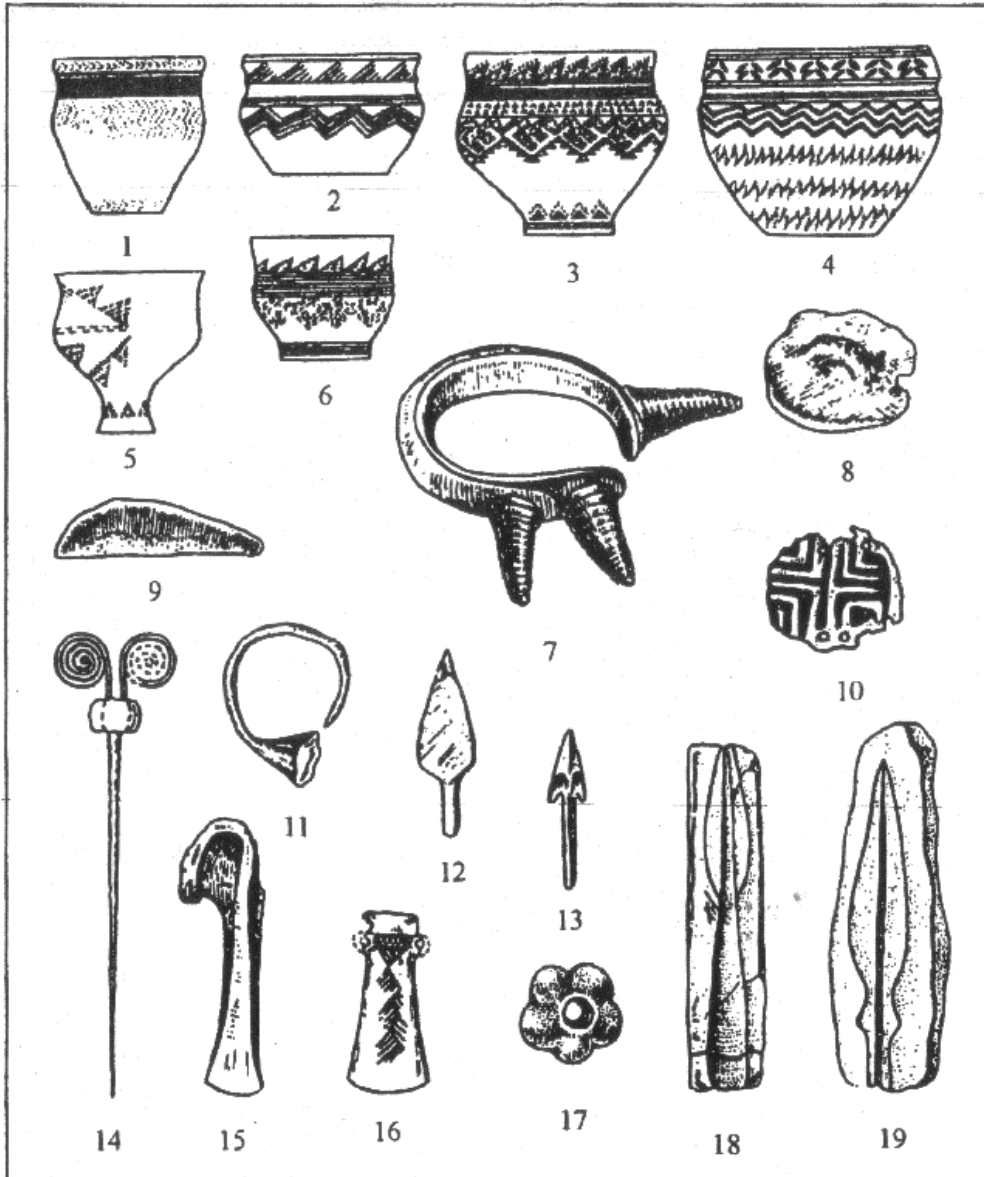


Fig. 143. Andronovo culture, pottery, bronze and stone objects (after Masson 1992, 349 Fig. 4).

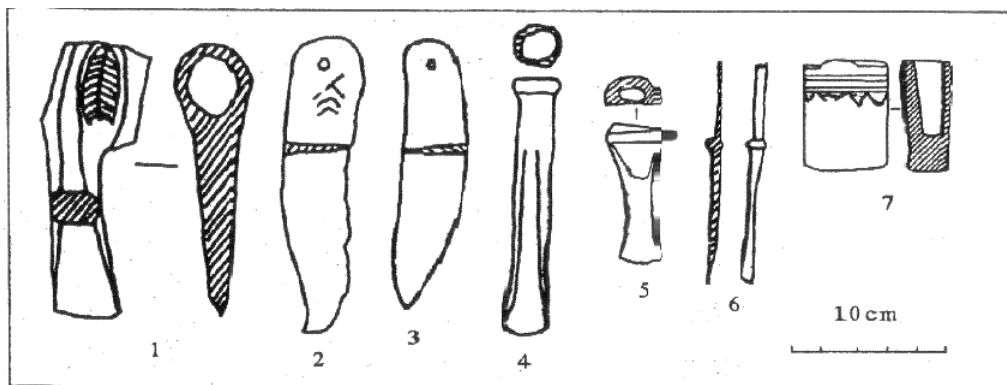


Fig. 144. Aga'ergen, Gongliu, Xinjiang, copper and bronze artifacts (after MJJ 2000, 94 Fig. 2.22).

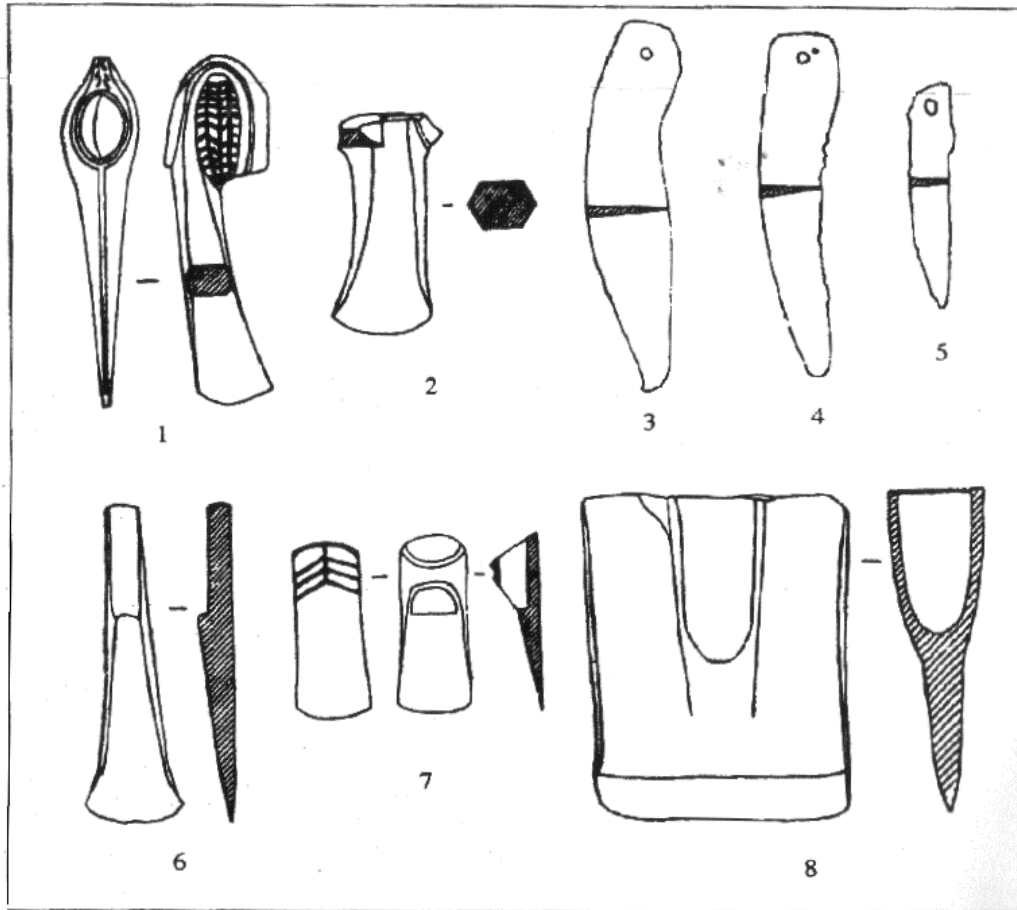


Fig. 145a. Bronze implements of Andronovo-type recovered in the Tacheng region, Xinjiang, 1-2 shaft-hole axes, L 25cm.11.8cm; 3-5 sickles, L 24cm.22.3cm.14.8cm; 6 flanged adze, L 17.3cm; 7 socketed celt, L 9.5cm; 8 spade, L14cm (after MJJ 2000, 95 Fig. 2.24)

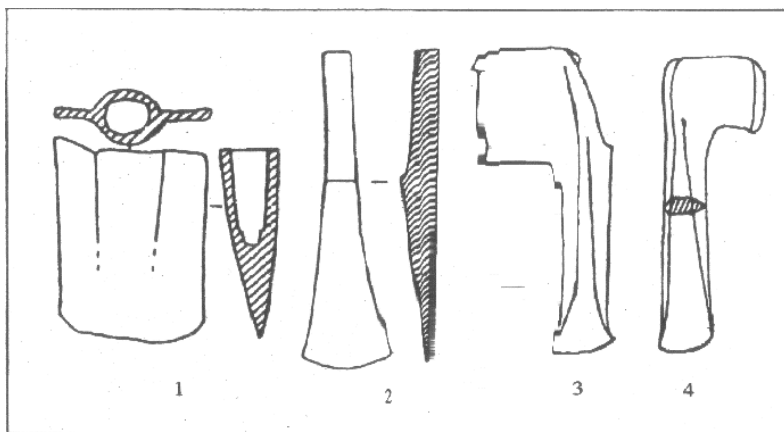


Fig. 145b. Copper and bronze objects of Andronovo-type recovered in the central part of Xinjiang: 1 Spade from Urumuqi, L 12.4cm; 2 flanged axe from Urumuqi, L 14.7cm; 3-4 shaft-hole axes from Jimusa'er and Qitai L 18cm.23cm (after MJJ 2000, 96 Fig. 2.26).

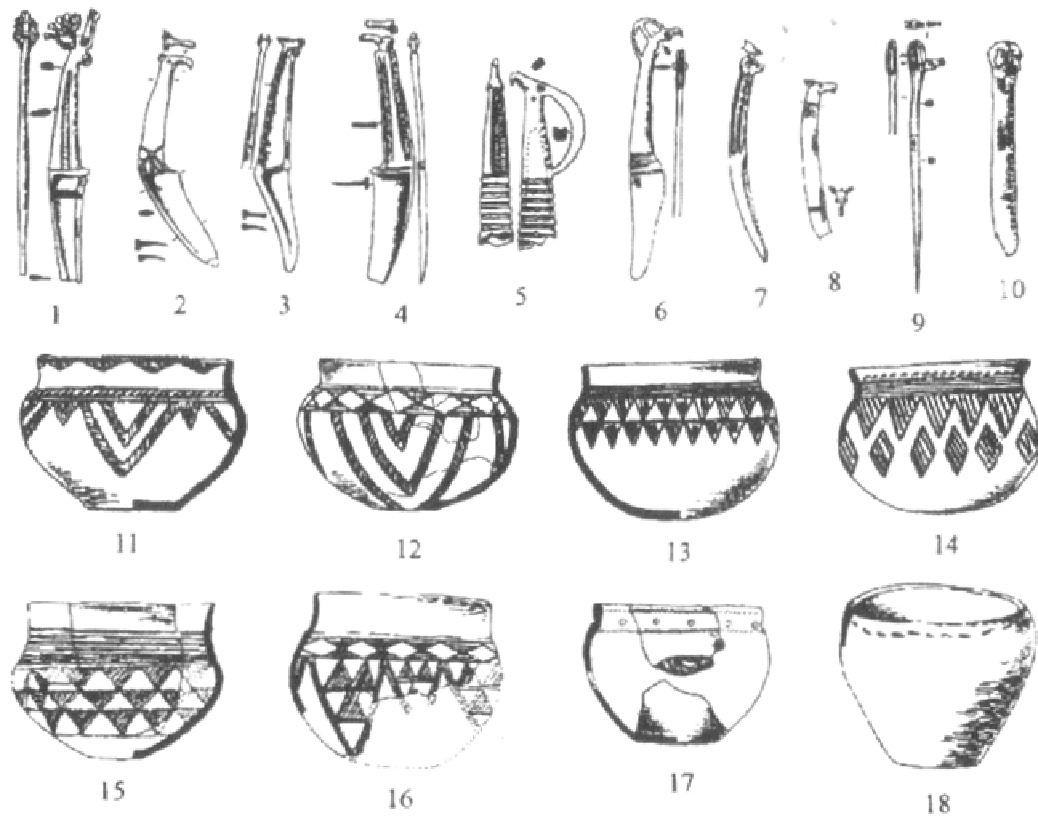


Fig. 146. Karasuk culture, metal and pottery objects, 1-10 metal objects; 11-18 potteries (after MJJ 2000, 169 Fig. 6.11).

Appendix: List of the Radiocarbon dates. Dates are calibrated by Cal 510 (Stuiver et al., 2005).

Location	Site coordinates (E/N)	Laboratory No.	Material	Radiocarbon age B.P.(5730)	Calibrated age BC (probably 68.3%)	Calibrated age BC (probably 95.4%)	Reference	Published cultural allotment
Ahatela, Xunhua, QH	102°24', 35°48'	BK81028	M158 wood ash	2630±100	914- 748	1003--486	C14 91, 289	Kayue
Ahatela, Xunhua, QH	102°24', 35°48'	BK81030	M256 wood ash	2860±100	1133 -909	1311-818	C14 91, 289	Xindian/Kayue
Ahatelashan, Xunhua, QH	102°24', 35°48'	BK81026	M12 wood ash	3230±80	1541-1 430	1692-1372	C14 91, 289	Kayue
Ahatelashan, Xunhua, QH	102°24', 35°48'	BK81027	M207 wood ash	3450±80	1884- 1681	1955-1602	C14 91, 289	Kayue
Baifu, Changping, BJ	116°8', 40°19'	BK75052	M1-5 coffin wood	2980±90	131 8-1111	1422-975	C14 91, 16	Western Zhou
Baifu, Changping, BJ	116°8', 40°19'	WB77-05	M1 coffin wood	2810±100	1058 -841	1224-802	C14 91, 16	Western Zhou
Baimiao, Zhangjiakou, HB	115°23', 40°39'	ZK0765	M64 coffin wood	2910±150	129 7-926	1447-804	ZSKKS 1982, 657	?
Changshan, Zhenyuan, GS	107°8', 34°40'	ZK 830	charcoal	4260±80	2943-2851	3 039-2619	ZSKKS 1981, 366	Qijia
Dahezhuang, Yongjing, GS	103°22', 35°54'	ZK15	F7:2 charcoal	3580±95	2037-18 64	2153-1689	ZKK 1972, 55	Qijia
Dahezhuang, Yongjing, GS	103°22', 35°54'	ZK23	F7:2 charcoal	3540±95	1979-174 8	2137-1636	ZKK 1972, 55	Qijia
Dahuacun, Huangyuan, QH	101°18', 36°42'	ZK1323	coffin wood	1780±80	AD 135- 268	AD 69-421	C14 91, 289	Kayue
Dayukou, Guinan, QH	100°44', 35°35'	ZK1325	coffin wood	2720±115	1028-77 8	1215-727	C14 91, 287	Kayue
Dianjiangtai, Chifeng, NMG	118°54'; 42°12'	ZK2649	T112H37 charcoal	2525±46	64 6-551	801-509	ZSKKS 1993, 645	Upper Xiajiadian
Dianjiangtai, Chifeng, NMG	118°54'; 42°12'	ZK2650	T106H35 charcoal	2515±48	64 9-546	797-505	ZSKKS 1993, 645	Upper Xiajiadian

Dianjiangtai, Chifeng, NMG	118°54'; 42°12'	ZK2651	T103(13) charcoal	3253±58	1563-1491	1666-1418	ZSKKS 1993, 646	Lower Xiajiadian
Fengtai, Huzhu, QH	101°95', 36°84'	Bin5413	charcoal	2564±36	802-754	80 7-740	Xu X. G. et al. 2003, 96	Kayue
Fengtai, Huzhu, QH	101°95', 36°84'	Bin5414	charcoal	2690±34	848-807	90 3-802	Xu X. G. et al. 2003, 96	Kayue
Fengtai, Huzhu, QH	101°95', 36°84'	Bin5415	charcoal	2729±36	903-833	93 5-809	Xu X. G. et al. 2003, 96	Kayue
Fengtai, Huzhu, QH	101°95', 36°84'	Bin5416	charcoal	2868±32	1092-1000	1129-927	Xu X. G. et al. 2003, 96	Kayue
Fengtai, Huzhu, QH	101°95', 36°84'	KIA16584	charcoal	2975±25	1262-1191	1302-1122	Xu X. G. et al. 2003, 96	Kayue
Fengtai, Huzhu, QH	101°95', 36°84'	KIA16585	charcoal	2950±25	1213-1126	1262-1110	Xu X. G. et al. 2003, 96	Kayue
Fengtai, Huzhu, QH	101°95', 36°84'	KIA16586	charcoal	2880±25	1060-1012	1130-976	Xu X. G. et al. 2003, 96	Kayue
Fengtai, Huzhu, QH	101°95', 36°84'	KIA16587	charcoal	2615±25	808-791	8 20-774	Xu X. G. et al. 2003, 96	Kayue
Fengtai, Huzhu, QH	101°95', 36°84'	KIA16588	charcoal	2870±25	1058-1004	1126-974	Xu X. G. et al. 2003, 96	Kayue
Fengtai, Huzhu, QH	101°95', 36°84'	KIA16589	charcoal	2885±25	1089-1018	1131-979	Xu X. G. et al. 2003, 96	Kayue
Fengtai, Huzhu, QH	101°95', 36°84'	KIA16590	charcoal	2645±25	819-798	8 39-790	Xu X. G. et al. 2003, 96	Kayue
Fengtai, Huzhu, QH	101°95', 36°84'	KIA16591	charcoal	2730±25	897-840,	920-819	Xu X. G. et al. 2003, 96	Kayue
Fengtai, Huzhu, QH	101°95', 36°84'	KIA16592	charcoal	2865±25	1057-998	1123-973	Xu X. G. et al. 2003, 96	Kayue
Fengtai, Huzhu, QH	101°95', 36°84'	KIA16593	charcoal	2755±30	923-887	9 77-827	Xu X. G. et al. 2003, 96	Kayue
Fengtai, Huzhu, QH	101°95', 36°84'	KIA16594	charcoal	2915±30	1132-1048	1213-1012	Xu X. G. et al. 2003, 96	Kayue
Ganguya, Jiuquan, GS	98°49', 39°73'	BK87059	M41	3450±40	1779-1731	1855-1 667	Pak Y. J. 1996, 285	Siba
Ganguya,	98°49', 39°73'	BK87060	M63, M64	3390±70	17 71-1607	1880-1523	Pak Y. J. 1996,	Siba

Jiuquan, GS							285	
Ganguya, Jiuquan, GS	98°49', 39°73'	BK87063	M32, M48	3220±60	1534-1425	1 637-1387	Pak Y. J. 1996, 285	Siba
Ganguya, Jiuquan, GS	98°49', 39°73'	BK89028	M92	3130±60	1460-1371	1523-1 260	Pak Y. J. 1996, 285	Siba
Gaoquding, Guinan, QH	100°44', 35°35'	BK77052	T101 charcoal	3700±90	2205- 1852	2350-1878	C14 91, 286	Qijia
Gaoquding, Guinan, QH	100°44', 35°35'	BK77053	T101 charcoal	3620±150	2151 -1859	2368-1627	C14 91, 286	Qijia
Guantang, Guinan, QH	100°44', 35°35'	ZK1326	coffin wood	2980±75	1317-111 4	1408-1008	C14 91, 287	Kayue
Hamatun, Yongchang, GS	101°58', 38°14'	ZK789	wood	2645±80	915-761	1002-716	C14 91, 274	Shajing
Huoshagou, Yumen, GS	97°42', 39°57'	BK77008	T42 (3):3 charcoal	3250±100	1636-1422	1769-1298	C14 91, 272	Siba
Huoshagou, Yumen, GS	97°42', 39°57'	ZK0408	M84 charcoal	3300±85	1686-149 7	773-1411	C14 91, 272	Siba
Huoshagou, Yumen, GS	97°42', 39°57'	ZK0409	T1(2)F charcoal	3490±100	1940 -1689	2041-1602	C14 91, 272	Siba
Huoshagou, Yumen, GS	97°42', 39°57'	ZK77010	M84 wood	3350±100	1748-1512	1886-1433	C14 91 272	Siba
Jiatuhu, Guinan, QH	100°44', 35°35'	BK77055	wood ash	2930±90	1266-1007	1388-916	C14 91, 287	Kayue
Jiuzhan, Heshui, GS	108°8', 35°48'	BK85025	T64CH6 charcoal	2960±120	1 316-1018	1447-895	C14 91, 280	Siwa
Jiuzhan, Heshui, GS	108°8', 35°48'	BK85027	M33 charcoal	2390±140	670- 383	814-164	C14 91, 280	Siwa
Jiuzhan, Heshui, GS	108°8', 35°48'	ZK0757	charcoal	3050±95	1424-1193	14 99-1023	C14 91, 280	Siwa
Lanqiao, Xihe, GS	105°12', 34°	BK83028	human bone	3010±120	1410-1113	1499-923	C14 91, 284	Siwa
Lianhuatai, Linxia, GS	108°8', 35°48'	BK 84103	M3 human bone	2540±120	807- 512	910-393	C14 91, 284	Siwa
Linjia, Dongxiang, GS	103°21', 35°39'	ZK521	H19 charcoal	4235±85	2816-26 70	3027-2575	C14 83, 134	Majiyao

Linjia, Dongxiang, GS	103°21', 35°39'	ZK522	F21 millet	4105±95	2762-2571	2903-2463	C14 83, 134	Majiyao
Linjia, Dongxiang, GS	103°21', 35°39'	ZK523	F20 charcoal	4540±80	3245-310 1	3384-3010	C14 83, 134	Majiyao
Linziliang, Haiyuan, NX	105°36', 36°30'	ZK2226	T3(3C)F3(2) charcoal	3725±95	2234-2013	2368-1893	ZSKKS 1989, 660	Majiazao-Qijia
Linziliang, Haiyuan, NX	105°36', 36°30'	ZK2227	T5(3C)H5 charcoal	3935±150	2627-2199	2874-2111	ZSKKS 1989, 660	Majiazao-Qijia
Linziliang, Haiyuan, NX	105°36', 36°30'	ZK2236	T2(4)H10 charcoal	3555±55	19 74-1872	2034-1743	ZSKKS 1989, 660	Majiazao-Qijia
Linziliang, Haiyuan, NX	105°36', 36°30'	ZK2237	T3(C)F3Y1 charcoal	4025±110	2701-2457	2883-2283	ZSKKS 1989, 660	Majiazao-Qijia
Linziliang, Haiyuan, NX	105°36', 36°30'	ZK2238	T3(3E) charcoal	3760±55	2214 -2129	2347-2019	ZSKKS 1989, 660	Majiazao-Qijia
Linziliang, Haiyuan, NX	105°36', 36°30'	ZK2239	T3(3F)F6 charcoal	3805±55	23 10-2191	2460-2131	ZSKKS 1989, 660	Majiazao-Qijia
Linziliang, Haiyuan, NX	105°36', 36°30'	ZK2475	T6(4)F10 charcoal	3695±100	2 207-1941	2351-1873	ZSKKS 1990, 667	Majiazao-Qijia
Linziliang, Haiyuan, NX	105°36', 36°30'	ZK2476	T18(3A)F13Y2 charcoal	3700±80	2202-2007	2345-1883	ZSKKS 1990, 667	Majiazao-Qijia
Linziliang, Haiyuan, NX	105°36', 36°30'	ZK2477	T18(3A)F13 charcoal	3750±100	2300-2022	2466-1919	ZSKKS 1990, 667	Majiazao-Qijia
Linziliang, Haiyuan, NX	105°36', 36°30'	ZK2478	T9(3A)F9(2) charcoal	3760±105	2214-2129	2347-2019	ZSKKS 1990, 668	Majiazao-Qijia
Linziliang, Haiyuan, NX	105°36', 36°30'	ZK2479	T22(2B)F11 charcoal	3825±90	2356-2195	2492-2025	ZSKKS 1990, 668	Majiazao-Qijia
Linziliang, Haiyuan, NX	105°36', 36°30'	ZK2480	T22(2B)F11 charcoal	3675±80	2145-1946	2295-1876	ZSKKS 1990, 668	Majiazao-Qijia
Linziliang, Haiyuan, NX	105°36', 36°30'	ZK2481	T9(3A)H44 charcoal	3685±120	2209-1901	2370-1769	ZSKKS 1990, 668	Majiazao-Qijia
Linziliang, Haiyuan, NX	105°36', 36°30'	ZK2482	T7(2B)F12 charcoal	3840±125	2473-2135	2626-1928	ZSKKS 1990, 668	Majiazao-Qijia
Liujiafen, Jixian, TJ	117°18', 40°	ZK2153	T194-5, 184-5 charcoal	2770±75	999-836	1119-802	C14 91, 19	Western Zhou
Liujiafen, Jixian,	117°18', 40°	ZK2154	T82(2) charc oal	2980±75	1317-1114	1408-1008	C14 91, 19	Western Zhou

TJ								
Liujiafen, Jixian, TJ	117°18', 40°	ZK2155	T86(2) charcoal	2920±80	1219-10 09	1320-915	C14 91, 19	Western Zhou
Liuwan, Ledu, QH	102°30', 36°30'	BK346	coffin wood	3560±80	1849-1773	2065-1730	ZSKKS 1978, 286	Machang
Liuwan, Ledu, QH	102°30', 36°30'	BK75010	M266 coffin wood	3730±90	2234-2019	2351-1907	BDS 1976, 84	Qijia
Liuwan, Ledu, QH	102°30', 36°30'	ZK347	M392 coffin wood	3470±140	1965-1615	2141-1488	ZSKKS 1978, 286	Qijia
Maluyuan, Yongjing, GS	103°22', 36°54'	BK84106	(2)H9 charcoal	3080±95	1449 -1212	1530-1045	C14 91, 275	Xindian
Maluyuan, Yongjing, GS	103°22', 36°54'	BK84108	(3)H35 charcoal	2920±110	12 70-976	1406-894	C14 91, 275	Xindian
Maoqinggou, Liangcheng, NMG	112°31', 40°32'	BK80005	M23 coffin wood	2470±90	671 -507	791-402	C14 91, 59	Maoqinggou
Maoqinggou, Liangcheng, NMG	112°31', 40°32'	BK80006	M25 charcoal	2230±90	392-19 8	425-42	C14 91, 59	Maoqinggou
Maoqinggou, Liangcheng, NMG	112°31', 40°32'	BK80026	Y1 charcoal	2550±70	649-546	818-484	C14 91, 59	Maoqinggou
Nianzipo, Changwu, SHX	107°45', 35°8'	ZK1230	T807③ charcoal	2690±75	915-797	1048-754	ZSKKS 1986, 656	Pre-Zhou
Nuomuhong, Dulan, QH	96°24', 36°27'	ZK0061	wooden post	3670±90	2148-1931	2301-1862	C14 83, 142	Nuomuhong
Nuomuhong, Dulan, QH	96°24', 36°27'	ZK0062	woolen cloth	2720±115	1028-78 8	1215-727	C14 91, 285	Nuomuhong
Panjialiang, Huangzhong, QH	101°6', 35°7'	ZK1327	M78 human bones	2660±115	996-7 51	1057-483	ZSKKS 1986, 659	Kayue
Qianbao, Yuxian, HB	114°53' 39°58'	ZK2015	M203 charcoal	3340±170	1781 -1440	2050-1254	C14 91, 27	Datuotou
Qiaocun, Lingtai, GS	107°37', 35°5'	ZK741	H4 charcoal	3675±60	2139-1973	2205-1893	C14 83, 136	Qijia
Qijiaping, Guanghe, GS	104°34', 35°28'	ZK410	T1③ charcoal	4010±105	2678-2430	2876-2282	C14 91, 134	Qijia
Sanguan, Yuxian, HB	114°47', 39°55'	WB82-22	F119 charcoal	3810±90	2350- 2138	2487-2014	C14 91, 25	Datuotou

Sanguan, Yuxian, HB	114°47', 39°55'	WB82-39	T2010H2065 charcoal	3160±80	1522-1372	1624-1256	C14 91, 25	Datuotou
Sanguan, Yuxian, HB	114°47', 39°55'	WB82-40	T2011H2072 charcoal	3560±195	2146-1664	2463-1492	C14 91, 26	Datuotou
Sanguan, Yuxian, HB	114°47', 39°55'	WB84-18	T2034Y2001 charcoal	3180±85	1534-1376	1666-1260	C14 91, 26	Datuotou
Sanguan, Yuxian, HB	114°47', 39°55'	WB84-30	T2031Y2129 charcoal	3180±70	1528-1387	1621-1295	C14 91, 26	Datuotou
Sanguan, Yuxian, HB	114°47', 39°55'	ZK2016	M2008 charcoal	3155±105	1532 -1292	1670-1152	C14 91, 26	Datuotou
Saojiaocheng, Yongchang, GS	101°58', 38°14'	BK79030	charcoal	2530±90	695-539	81 5-407	C14 91, 273	Shajing
Saojiaocheng, Yongchang, GS	101°58', 38°14'	BK79062	M5 wood	2650±95	933-752	103 0-509	C14 91, 273	Shajing
Saojiaocheng, Yongchang, GS	101°58', 38°14'	BK79063	M11 wood	2600±125	695-540	1 001-403	C14 91, 273	Shajing
Saojiaocheng, Yongchang, GS	101°58', 38°14'	BK79064	M14 wood	2500±90	776-522	79 9-407	C14 91, 273	Shajing
Saojiaocheng, Yongchang, GS	101°58', 38°14'	BK79065	M15 wood	2870±160	1264-895	1462-767	C14 91, 273	Shajing
Saojiaocheng, Yongchang, GS	101°58', 38°14'	BK79066	M18 wood	2770±90	1013-821	1 134-792	C14 91, 273	Shajing
Saojiaocheng, Yongchang, GS	101°58', 38°14'	ZK739	botton of ash	2600±100	849-73 2, 651-544	928-411	C14 83, 133	Shajing
Shangsunjiazhai, Datong, QH	101°40', 36°56'	BK77013	coffin wood	4320±90	3097-28 71	3136-2836	C14 91, 287	Majiyao
Shangsunjiazhai, Datong, QH	101°40', 36°56'	BK77014	M333 coffin wood	2860±90	11 31-912	1294-830	C14 91, 287	Tangwang-style pottery
Shangsunjiazhai, Datong, QH	101°40', 36°56'	BK80011	M979 coffin wood	2510±80	78 7-705, 695-539	797-477	C14 91, 288	Kayue
Shangsunjiazhai, Datong, QH	101°40', 36°56'	BK80012	M989 coffin wood	2430±80	5 56-404	774-393	C14 91, 288	Kayue
Shangsunjiazhai, Datong, QH	101°40', 36°56'	BK80013	M1042 coffin wood	2580±80	8 24-736	897-486	C14 91, 288	Kayue
Shangsunjiazhai, Datong, QH	101°40', 36°56'	BK80014	M1046 coff in wood	2930±80	1222-1018	1323-923	C14 91, 288	Kayue

Datong, QH								
Shanpingtai, Guide, QH	101°27', 36'2"	ZK1105	M19 wood	2640±70	899-769	943- 729	C14 91, 288	Kayue
Shanpingtai, Guide, QH	101°27', 36'2"	ZK1107	M44 wood	2610±60	842-752	906- 726	C14 91, 288	Kayue
Shizhaocun, Tianshui, GS	105°42', 34'36"	ZK1283	T104 charcoal	3760±80	2292-2 112	2411-1975	C14 91, 282	Qijia
Shizhaocun, Tianshui, GS	105°42', 34'36"	ZK1371	T403H1 charcoal	3790±85	2346 -2129	2469-2016	C14 91, 282	Qijia
Taohongbala, Hanjinqi, NMG	109°40', 39'55"	ZK0266	M1 wood	2540±105	803-537	848 -400	C14 91, 54	Taohongbala
Xigang, Yongchang, GS	101°58', 38'14"	ZK792	M26 wood	2620±90	902-748	944- 501	C14 91, 274	Shajing
Xishanping, Tianshui, GS	105°42', 34'36"	ZK2149	T1(3) charcoal	3500±215	2056 -1604	2466-1380	C14 91, 283	Qijia
Xishanping, Tianshui, GS	105°42', 34'36"	ZK2150	T1(4) charcoal	3860±155	2496 -2131	2703-1901	C14 91, 283	Majiayao
Xishanping, Tianshui, GS	105°42', 34'36"	ZK2205	T10(3) charcoal	3640±80	2064 -1912	2208-1858	C14 91, 284	Qijia
Xujianian, Zhuanglang, GS	105°54', 35'21"	ZK0901	M79 humen bone	2320±80	516-3 51	595-191	C14 91, 280	Siwa
Xujianian, Zhuanglang, GS	105°54', 35'21"	ZK0902	M81 humen bone	2590±80	883-7 40	904-501	C14 91, 280	Siwa
Xujianian, Zhuanglang, GS	105°54', 35'21"	ZK0903	M82 humen bone	2400±90	557-3 93	789-357	C14 91, 280	Siwa
Yuhuangmiao, BJ	115°96', 40'36"	BK87101	M25 charcoa l	2720±80	934-804	1088-769	Pak Y.J. 1996, 429	Yuhuangmiao
Yuhuangmiao, BJ	115°96', 40'36"	BK90046	M282	3625±8 0	2057-1889	2202-1766	Pak Y.J. 1996, 429	Yuhuangmiao
Yuhuangmiao, BJ	115°96', 40'36"	BK90049	M156	2795±1 00	1056-828	1219-796	Pak Y.J. 1996, 429	Yuhuangmiao
Yuhuangmiao, BJ	115°96', 40'36"	BK90050	M129	2465±9 0	669-506	790-401	Pak Y.J. 1996, 429	Yuhuangmiao
Zhizhushan, Chifeng, NMG	118°57', 42'20"	ZK0176	H42 charcoal	3850±90	2549-22 63	2498-2113	C14 91, 55	Lower Xiajiadian

Zhukaigou, NMG	110°3', 39°36'	BK79053	IIIT23(5) charcoal	4320±90	3097-2871	3136-2836	C14 91, 59	Zhukaigou
Zhukaigou, NMG	110°3', 39°36'	BK80028	V(2)H5018char coal	3320±70	1684-1522	1755-1437	C14 91, 60	Zhukaigou
Zhukaigou, NMG	110°3', 39°36'	WB84-76	(3)H1071, 10 73 charcoal	3220±70	1536-1420	1670-1379	C14 91, 60	Zhukaigou
Zhukaigou, NMG	110°3', 39°36'	WB84-77	(3)H1055 charcoal	3190±75	1533-1390	1658-1292	C14 91, 60	Zhukaigou
Zhukaigou, NMG	110°3', 39°36'	WB84-78	IT288(4) charcoal	4680±80	3525-3368	3645-3329	C14 91, 60	Zhukaigou
Zhukaigou, NMG	110°3', 39°36'	WB84-79	(4) H1058 charcoal	3420±70	1778-1629	1894-1598	C14 91, 60	Zhukaigou

Bibliography

Abbreviations Used in Reference

- BDXB Beijing daxue xuebao 北京大学学报
BFWW Beifang wenwu 北方文物
BJWB Beijing wenbo 北京文博
BJKY Bianjiang kaogu yanjiu 边疆考古研究
BJWK Beijing wenwu yu kaogu 北京文物与考古
BMFEA Bulletin of the Museum of Far Eastern Antiquities
GXYJ Guoxue yanjiu 国学研究
GJK Gugong xueshu jikan 故宫学术季刊
GGWWYK Gugong wenwu yuekan 故宫文物月刊
GGYK Gugong bowuyuan yuankan 故宫博物院院刊
HXKG Huaxia kaogu 华夏考古
JHKG Jiangnan kaogu 江汉考古
KG Kaogu 考古
KGTX Kaogu tongxun 考古通讯
KGXB Kaoguxuebao 考古学报
KGXJ Kaoguxue jikan 考古学集刊
KWL Kaoguxue wenhua lunji 考古学文化论集
KY Kaoguxue yanjiu 考古学研究
KYW Kaogu yu wenwu 考古与文物
LHW Liaohai wenwu xuekan 辽海文物学刊
LYY Lishi yuyan yanjiusuo jikan 历史语言研究所集刊
Nianhui 8 Zhongguo kaoguxuehui di ba ci nianhui lunwenji 中国考古学会第一次年
八次年会论文集
Nianhui 1 Zhongguo kaoguxuehui di yi ci nianhui lunwenji 中国考古学会第一次年
一次年会论文集
NMGWK Neimenggu wenwu kaogu 内蒙古文物考古
NMGWKW Neimenggu wenwu kaogu wenji 内蒙古文物考古文集
NMGWX Neimenggu chutu wentuxuanji 内蒙古出土文物选集
NYKG Nongye kaogu 农业考古
QHKH Qinghaisheng kaogu xuehuihuikan 青海省考古学会会刊
QHWW Qinghai wenwu 青海文物

SQYJ	Shiqian yanjiu 史前研究
SXYK	Shixue yuekan 史学月刊
WB	Wenbo 文博
WWJK	Wenwu jikan 文物季刊
WW	Wenwu 文物
WWCZ	Wenwu Cankao ziliao 文物参考资料
WWZC	Wenwu ziliao congkan 文物资料丛刊
WWCQ	Wenwu Chunqiu 文物春秋
WB	Wenwubao 文物报
XBSD	Xibei shidi 西北史地
XYYJ	Xiyu yanjiu 西域研究
XJWW	Xinjiang wenwu 新疆文物
YJXB	Yanjing xuebao 燕京学报
ZKN	Zhongguo kaoguxue nianjian 中国考古学年鉴
ZKS	Zhongguo keji shiliao 中国科技史料
ZKY	Ziran kexueshi zhanjiu 自然科学史研究
ZWB	Zhongguo wenwubao 中国文物报
ZYWW	Zhongyuan Wenwu 中原文物
ZYLYY	Zhongyang yanjiuyuan lishi yuyan yanjiusuo 中央研究院历史语言研究所
ZKXB	Zhongguo kaogu xuebao 中国考古学学报

Arne 1933

T. J. Arne, Die Funde von Luanping and Hsuan hua . BMFEA 5, 1933, I-VIII; XIV, 2.

An Z. M. 1954

An Zhimin 安志敏, Tangshan shiguanmu jiqi xiangguan de yiwu 唐山石棺墓及其相关的遗物 [Cist graves at Tangshan and related remains]. KGXB 7, 1954, 81-82.

An Z. M. 1956

An Zhimin 安志敏, Gansu yuangu wenhua jiqi youguan de jige wenti 甘肃远古文化及其有关的几个问题 [On ancient cultures in Gansu and related questions]. KGTX 6, 1956, 9-11.

An Z. M. 1957

An Zhimin 安志敏, Lue lun Gansu Dongxiang zizhixian Tangwangchuan de taoqi 略论甘肃东乡自治县唐汪川的陶器 [Pottery at Tangwangchuan, Dongxiang, Gansu]. KGXB 2, 1957, 23-31.

An Z. M. 1959a

An Zhimin 安志敏, Qinghai de gudai wenhua 青海的古代文化 [Ancient cultures in Qinghai].

KG 7, 1959, 375-383.

An Z. M. 1959b

An Zhimin 安志敏, Gansu Shandan Sibatan xinshiqi shidai yizhi 甘肃山丹四坝滩新石器时代遗址 [Neolithic sites in Sibatan, Shandan, Gansu]. KGXB 3, 1959, 7-16.

An Z. M. 1981

An Zhimin 安志敏, Zhongguo zaoqi tongqi de jige wenti 中国早期铜器的几个问题 [Some problems concerning China's early copper and bronze artifacts]. KGXB 3, 1981, 269-285.

An Z. M. 1992

An Zhimin 安志敏, The Bronze Age in eastern parts of Central Asia In: History of Civilization of Central Asia I - the Dawn of Civilization: earliest times to 700 B.C. (Unesco 1992), 319-396.

An Z. M. 1993

An Zhimin 安志敏, Shilun zhongguode zaoqi tongqi 试论中国的早期铜器 [On early copper and bronze objects in ancient China]. KG 12, 1993, 1110-1119.

An Z. M. 2000

An Zhimin 安志敏, On early copper and bronze objects in ancient China . In: Linduff et al. 2000, 29-46.

Andersson 1925

J. D. Andersson, Preliminary Report on Archaeological Research in Kansu (Beijing 1925), 1-56 .

Andersson 1929

J. D. Andersson, Der Weg über die Steppen. BMFEA, 1929, 149.

Andersson 1932

J. D. Andersson, Hunting magic in animal style. BMFEA 4, 1932, 224.

Andersson 1933

J. D. Andersson, Selected Ordos Bronzes . BMFEA 5, 1933.

Andersson 1935

J. D. Andersson, Children of the Yellow Earth: studies in prehistoric China (Mit Press 1935).

Andersson 1943

J. D. Andersson, Researches into the Prehistory of the Chinese. BMFEA 15, 1945, 1-304.

Andersson 1945

J. D. Andersson, Chu Chia Chai. BMFEA 17, 1945, 1-63.

Anxi 1987

Anxixian bowuguan 安西县博物馆, Gansu Anxixian faxian yichu xinshiqi shidai yizhi 甘肃安西县发现一处新石器时代遗址 [One Neolithic site discovered in Anxi county, Gansu]. KG 1, 1987, 91-96.

Bai G. 1999

Bai Guang 白光, Fengning Tucheng Dongdaogouxia shanrong mu 丰宁土城东道沟下山戎墓 [The Shanrong burials at Dongdaogou, Tucheng, Fengning]. WW 11, 1999, 23-27.

Bai Y. X. 2002

Bai Yunxiang 白云翔, *Zhongguo de zaoqi tongqi yu qingtongqi de qi yuan* 中国的早期铜器与青铜器的起源 [On the earliest copper and bronze objects and their origins]. DNWH 7, 2002, 25-37.

Barnard 1961

N. Barnard, *Bronze casting and bronze alloys in ancient China* (Tokyo). Monumental Serial Monograph 14, 1961.

Barnard 1983

N. Barnard, Further evidence to support the hypothesis of indigenous origins of metallurgy in ancient China. In: Berkeley 1983, 237-277.

BD 1991

Beijing daxue kaoguxuexi 北京大学考古学系, *Liangcheng xian Yangchanggou yizhi qingli jianbao* 凉城县杨厂沟遗址清理简报 [Excavation at Yangchanggou, in Liangcheng county]. NMGWK 1, 1991.

BD 1992

Beijing daxue kaoguxuexi 北京大学考古学系, *Gansusheng huluhe liuyu kaogu diaocha* 甘肃省葫芦河流域考古调查 [Survey at Huluhe Valley of Gansu Province]. KG 11, 1992, 971-986.

BD et al. 1997

Beijing daxue kaoguxuexi 北京大学考古学系 et al., *Neimenggu Tuoketuoxian Haishengbulang yizhi fajue baogao* 内蒙古托克托县海生不浪遗址发掘报告 [Report on the excavation at Haishengbulang, Tuoketuo County, Inner Mongolia]. KY 3, 1997, 196-239.

BDS 1976

Beijing daxue kaoguxi tan shisi shiyanshi 北京大学考古系碳十四实验室, *Yeti shanshuo tanfa* 液体闪烁碳法 [Liquid scintillation radiocarbon dating]. WW 12, 1976, 84.

BDS 1979

Beijing daxue kaoguxi tan shisi shiyanshi 北京大学考古系碳十四实验室, *Tan shisi niandai ceding baogao (san)* 碳十四年代测定报告 (三) [Radiocarbon dating measurement (III)]. WW 12, 1979, 74-78.

BDS 1989

Beijing daxue kaoguxi tan shisi shiyanshi 北京大学考古系碳十四实验室, *Tan shisi niandai ceding baogao (ba)* 碳十四年代测定报告 (八) [Radiocarbon dating measurement (VIII)]. WW 11, 1989, 92.

BDS 1994

Beijing daxue kaoguxi tan shisi shiyanshi 北京大学考古系碳 14 实验室, *Tan shisi niandai ceding baogao (jiu)* 碳十四年代测定报告 (九) [The ninth report of radiocarbon dating measurement]. WW 4, 1994, 89-95.

BDW 1996

Baoding shi wenguansuo 保定市文管所, *Zhuozhou shi Songlindian diaocha jianbao* 涿州市松林店遗址调查简报 [Survey at the Songlindian site, Zhuozhou]. WWCQ 2, 1996.

BDWC 98

Beijing daxue bainian guoxue wencui. kaogujuan 北京大学百年国学文萃.考古卷 [Collected Work of 100 years of Sinology of Beijing University. Archaeology] (Beijing 1998).

Beifangcaoyuan 2007

Wu En 乌恩, Beifang caoyuan kaoguxue wenhua yanjiu-qingtongshidai zhi zaoqi tieqi shidai 北方草原考古学文化研究-青铜时代至早期铁器时代 [Research on the archaeological cultures in the northern steppes - from the Bronze Age to the early Iron Age] (Beijing 2007).

Beijing3040

Zhongguo Yinshang xuehui 中国殷商学会 ed., Beijing jiancheng 3040 nian ji yanwenming guoji xueshu yantaohui huiyi zhuanji 北京建城 3040 年暨燕文明国际学术研讨会会议专辑 [Papers of the international conference to commemorate the 3040th birthday of the founder of Beijing city, namely the Yan civilization] (Beijing 1997).

Bergman 1939

F. Bergman, Archaeological researches in Sinjiang: Especially the Lop-Nor region (Stockholm 1939).

Berkeley 1983

Berkeley (ed.), The Origin of Chinese Civilization (Studies on China, 1) (Los Angeles 1983).

Binford 1968

L. R. Binford, Archaeological perspectives. In: New Perspectives in Archaeology (Chicago 1968), 5-28.

BJB et al. 1978

Baoji county Museum 宝鸡县博物馆 et al., Baoji Zhuyuangou dengdi Xizhou mu 宝鸡竹园沟等地西周墓 [The Burials of the Western Zhou culture at Zhuyuangou of Baoji]. KG 5, 1978, 289-290.

BJGY 1981

Beijing gangtie xueyuan yejinshizu 北京钢铁学院冶金史组, Zhongguo zaoqi tongqi de chubu yanjiu 中国早期铜器的初步研究 [A Preliminary study of early Chinese copper and bronze artifacts]. KGXB 3, 1981, 287-302.

BJGY 2003

Beijing gangtie xueyuan yejinshizu 北京钢铁学院冶金史组, Huoshaogou Siba wenhua chengfen fenxi ji zhizuo jishu de yanjiu 火烧沟四坝文化铜器成分分析及制作技术的研究 [The bronzes of the Siba culture from Huoshaogao: a component analysis and manufacture technique study]. WW 8, 2003, 86-96.

BJKG40

Beijingshi wenwu yanjiusuo 北京市文物研究所, Beijing kaogu sishi nian 北京考古四十年 [Forty Years of Archaeology in Beijing] (Beijing 1990).

BJKYY 2001

Beijing keji daxue yejin yu cailiaoshi Yanji 北京科技大学冶金与材料史研究所, Xinjiang Hami Tianshan beilu mudi chutu tongqi de chubu yanjiu 新疆哈密天山北麓墓地出土铜器的初步研究 [Studies on the bronzes unearthed from the Tianshanbeilu cemetery in Hami, Xinjiang]. WW 6, 2001, 79-88.

BJWG 1976

Beijing shi wenwu guanlichu 北京市文物管理处, Beijing diqu de you yi zhongyao kaogu shouhuo 北京地区的又一最后那个要考古收获 [Another important archaeological discovery in the Beijing region]. KG 4, 1976, 246-263.

BJWG 1977

Beijing shi wenwu guanlichu 北京市文物管理处, Beijing shi pinggu xian faxian Shangdai muzang 北京市平谷县发现商代墓葬 [The Shang burials found at the Pinggu County, Beijing]. WW 11, 1977, 1-8.

BJWG 1978

Beijing shi wenwu guanlichu 北京市文物管理处, Beijing shi xin zhengji de Shangzhou qingtongqi 北京市新征集的商周青铜器 [The Shang and Zhou bronzes collected from Beijing]. WWZC 2, 1978, 14-21.

BJWG 1979

Beijing shi wenwu guanlichu 北京市文物管理处, Beijing shi Yanqing xian Xibozi cun jiaocang tongqi 北京市延庆市西拨子村窖藏铜器 [Bronzes found from hoard at Xibozi, Yanqing, Beijing]. KG 3, 1979, 227-230.

BJWG 1992

Beijing shi wenwu gongzuodui 北京市文物工作队, Beijing Pinggu Liujiahe yizhi diaocha 北京平谷刘家河遗址调查 [Survey at Liujiahe, Pinggu, Beijing]. BJWK 3, 1992, 51-64.

BJWY 1989

Beijing shi wenwu yanjiusuo 北京市文物研究所, Beijing shi Jumahe liuyu kaogu diaocha 北京市拒马河流域考古调查 [Archaeological survey in the Jumahe valley, Beijing]. KG 3, 1989, 205-218.

BJWY 1994

Beijing shi wenwu yanjiusuo 北京市文物研究所, Yanqing Longqingxia bieshu gongcheng zhong faxian de chunqiu shiqi muzang 延庆龙庆峡别墅工程中发现的春秋时期墓葬 [The Spring and Autumn burials found at the Longqingxia Villa Project in Yanqing]. BJWK4, 1994, 32-45.

BJWY 1999

Beijing shi wenwu yanjiusuo 北京市文物研究所, Beijing shi wenwu kaogu wushi nian 北京市考古五十年 [Fifty years of Archaeological Work in Beijing]. In: Wushinian 99, 1-27.

Borodino 1957

M. G. Borodino, Seima and their contemporaries, Proceedings of the Prehistory Society for 1956 (new series, vol, xxii).

Bu G. 1989

Bu Gong 卜工, Yan bei diqu Xia Shang shiqi de taoqi puxi 燕北地区夏商时期的陶鬲谱系 [On the pedigree of the potteries of the Xia and Shang period in the Yanbei region]. BFWW 2, 1989. 32-40.

Bu/Cheng 1995

Bu Yangwu 卜杨武/Cheng Xi 程玺, Neimenggu diqu tong(tie) fu(鍤)de faxian ji chubu yanjiu(内 蒙 古 地 区 铜 铁 鍤 的 发 现 及 初 步 研 究 [The discovery and primary study on the

bronze (iron) Fu in Inner Mongolia]. NMGWK 1&2, 1995, 14-19.

Bunker 1992a

E. C. Bunker, Yanqing Shanrong wenwu chutan 延庆山戎文物初探 [Primary research on the Shanrong remains in Yanqing]. BJWK 3.

Bunker 1992b

E. C. Bunker, Gold belt plaques in the Siberian treasure of Peter the great: Dating, Origins and Iconography. In: Foundations of Empire: Archaeology and Art of the Eurasian Steppes (Ethnographics Press 1992).

Bunker 1997

E. C. Bunker (ed.), Ancient bronzes of the eastern Eurasian Steppes from the Arthur M. Sackler Collections (New York 1997).

BWSR 1989

Beijing wenwu yanjiusuo Shanrong wenhua kaogudui 北京文物研究所山戎文化考古队, Beijing Yanqing Jundushan Dongzhou Shanrong(山戎) buluo mudi fajue jilue 北京延庆军都山东周山戎部落墓地发掘纪略 [A brief account of the excavation of the Eastern Zhou of the Shanrong tribes at Jundushan in Yanqing, Beijing]. WW 8, 1989, 17-35.

C14 83

Zhongguo shehui kexuyuan kaogu yanjiusuo 中国社会科学院考古研究所, Zhongguo kaoguxue zhong tan shisi niandai shujuji(1965-1981) 中国考古学中碳十四年代数据集 (1965-81) [Collection of C14 data in Chinese archaeology from 1965 to 1981] (Beijing 1983).

C14 91

Zhongguo shehui kexueyuan kaogu yanjiusuo 中国社会科学院考古研究所, Zhongguo kaoguxuezhong tan shisi niandai shujuji 中国考古学中碳十四年代数据集 (1965-1991) [Collection of C14 data in Chinese archaeology from 1965 to 1991] (Beijing 1991).

Cao J. E. 2001

Cao Jian'en 曹建恩, Qingshuihe xian zhengji de Shang Zhou qingtongqi 清水河县征集的商周青铜器 [The Shang and Zhou bronzes collected from the Qingshuihe county]. In: Wanjiashai (Huhehaote 2001).

Cao/Xu 1988

Cao Guilin 曹桂林/Xu Zhiguo 许志国, Liaoning Faku xian Wanliujie yizhi diaocha baogao 辽宁法库县湾柳街遗址调查报告 [Survey at Wanliujie, Faku county, Liaoning]. BFWW 2, 1988.

CDW et al. 1994

Chengde diqu wenu baohu guanlisuo 承德地区文物保护管理所/Luanping xian wenwu baohu guanlisuo 滦平县文物保护管理所, Hebeisheng Luanpingxian Lishugoumen muqun qingli fajue jianbao 河北省滦平县梨树沟门墓群清理发掘简报 [Excavation at the Lishugoumen cemetery in Luanping county, Hebei Province]. WWCQ 2, 1994, 15-30.

Chang 1963

K. Z. Chang, The archaeology of ancient China (New Haven 1963).

Chang 1986

- K. Z. Chang (ed.), *The archaeology of ancient China* (New Haven and London 1986).
- Chen 1987
Cheng-Yih Chen (ed.), *Science and Technology in Ancient Civilization* (Singapore 1987).
- Chen G. 1991
Chen Ge 陈戈, *Luelun Yanbulake wenhua 略论焉不拉克文化 [On Yanbulake culture]*. 西域研究 *Research of Western World* 1, 1991, 67-78.
- Chen G. 1997/1998
Chen Guang 陈光, *Dongzhou Yan wenhua fenqi lun 东周燕文化分期论 [Periodization of the Yan culture in Eastern Zhou]*. *BJWB* 4, 1997, 5-17; *BJWB* 1, 1998, 18-31; *BJWB* 2, 1998, 19-28.
- Chen H. H. 1990
Chen Honghai 陈洪海, *Muzang cailiao zhengli yu leixingxue yingyong-cong Hetaozhuang mudi de zhengli tanqi 墓葬材料整理与类型学应用-从核桃庄墓地的整理谈起 [Sorting out the burial materials and employing the typology-form the Hetaozhuang cemetery]*. *QHW* 5, 1990.
- Chen H. H. 2002a
Chen Honghai 陈洪海, *Ganqing diqu shiqianqi de huozangmu juli 甘青地区史前期的火葬墓举例 [Examples of cremation in prehistorical Gansu and Qinghai region]*. *KYW Supplement*, 2002, 150-152.
- Chen H. H. 2002b
Chen Honghai 陈洪海, *Gansu Qinghai diqu shiqian muzang zhong rengu chuli fangshi de chubu yanjiu 甘肃青海地区史前墓葬中人骨处理方式的初步研究 [Primary research of the disposal method of skeletons in prehistorical burials in the Gansu Qinghai region]*. In: *中国青海省におけるシルクロード研究、シルクロード学研究 vol.14*, 2002, 177-195.
- Chen H. H. 2003
Chen Honghai 陈洪海, *Gansu diqu shiqian muzang zhong de zangshi fenxi 甘青地区史前墓葬中的葬式分析 [Analysis on the burial manners of prehistorical Gansu and Qinghai region]*. *Gudai Wenming, 古代文明 Ancient Civilizations Vol.2*, 2003.
- Chen P. 1995
Chen Ping 陈平, *Luelun Shanrong wenhua de zushu ji xiangguan wenti 略论山戎文化的族属及相关问题 [Discussion on related people and questions of Shanrong culture]*. *HXKG* 3, 1995, 63-76.
- Chen T. M. et al. 1979
Chen Tiemei 陈铁梅/Yuan Sixun 原思训/Wang Liangxun 王良训/Ma Li 马力, *Tan shisi niandai ceding baogao (san) 碳十四年代测定报告 (三) [Radiocarbon dating measurement (iii)]*. *WW* 12, 1979, 74-78.
- Chen X. 2000
Chen Xu 陈旭, *Henan gudai qingtong yezhuye de xingqi 河南古代青铜冶铸业的兴起 [On the rise of the smelting and casting technology of bronzes in ancient Henan]*. In: *CX* 2000, 171-175.

Chen Y. 1999

Chen Yong 陈雍, Tianjin shi kaogu wushinian 天津市考古五十年 [Fifty years of archaeology in Tianjin]. In: Wushinian 99, 28-39.

Chen/Ge/Li 1998

Chen Honghai 陈洪海/Ge Sangben 格桑本/ Li Guolin 李国林, Shilun Zongri yizhi de wenhua xingzhi 试论宗日遗址的文化性质 [Discussion on the cultural ascription of the Zongri site]. KG 5, 1998, 15-26.

Chen/Hong 1982

Chen Yu 陈昱/Hong Fang 洪方, Longdongzhen Yuanchangshan xiaceng yizhi qianxi 陇东镇原常山下层遗存浅析 [Preliminary analysis on the lower remains of Yuanchangshan, Longdong]. KG 4, 1982, 392-397.

Cheng C. X. 1989

Cheng Changxin 程长新, Beijing faxian shang gui yu wen pan ji chunqiu songgong chai ge 北京发现商龟鱼纹盘及春秋宋公差戈 [Shang dish with tortoise and fish pattern and Spring and Autumn Songgongchai dagger found in Beijing]. WW 10, 1980.

Cheng T. K. 1974

Cheng Te-K'un, Metallurgy in Shang China. T'oung Pao, 60(4/5), 1974, 209-229.

Cheng X. Z. 1996

Cheng Xiaozhong 程晓钟, Gansusheng Zhuanglangxian chutu de gaoling daizu Li 甘肃省庄浪县出土的高领袋足鬲 [Li-tripods with high neck and bag-like feet unearthed from Zhuanglang county, Gansu Province]. HXKG 2, 1996, 89-91.

Chernykh 1992

E. N. Chernykh, Ancient Metallurgy in the USSR: The early Metal Age (Cambridge 1992).

Chi L. 1982

Chi Lei 迟雷, Guanyu quren qingtong duanjian de ruogan wenti 关于曲刃青铜短剑的若干问题 [Questions on the short bronze sword with a curved blade]. KG 1, 1982, 54-49.

Chu S. B. 1977

Chu Shibin 初仕宾, Gansu Lingtai Baicaoopo xizhoumu 甘肃灵台白草坡西周墓 [Western Zhou burials at Baicaoopo, Lingtai, Gansu]. KGXB 2, 1977, 99-130.

CHW et al. 1977

Changwei diqu yishuguan 昌潍地区艺术馆 et al, Shandong Jiaoxian Sanlihe yizhi fajue jianbao 山东胶县三里河遗址发掘简报 [Brief report on the excavation at Sanlihe, Jiaoxian, Shandong]. KG 4, 1997, 266.

CJ 1978

Changjiang liuyu gui Hua bangongshi kaogudui gansu fendui 长江流域规划办公室考古队甘肃分队, Bailongjiang liuyu kaogu diaocha jianbao 白龙江流域考古调查简报 [Report on the survey in the Bailongjiang valley]. WWZC 2, 1978, 26-34.

Cui L. M. 1994

Cui Liming 崔利明, Neimenggu Xinghexian Goulitou Xiongnu mu 内蒙古兴和县沟里头匈奴墓 [The Xiongnu tomb at Goulitou, Xinghe county, Inner Mongolia]. KG 5, 1994, 473.

Cui X. 1991

Cui Xuan 崔璿, Zhukaigou yizhi taoqi shixi 朱开沟遗址陶器试析 [Tentative research on potteries from the Zhukaigou site]. KG 4, 1991, 361-371.

CX 2000

Chen Xu 陈旭, Xia Shang wenhua lunji 夏商文化论集 [Collected work of the Xia and Shang cultures] (Beijing 2000).

Dadianzi 96

Zhongguo shehui kexueyuan kaogu yanjiusuo 中国社会科学院考古研究所, Dadianzi-Xiajiadian xiacheng wenhua yizhi yu mudi fajue baogao 大甸子-夏家店下层文化遗址与发掘报告 [Excavation of one Lower Xiajiadian culture site at Dadianzi] (Beijing 1996).

Dai Y. X. 1976

Dai Yingxin 戴应新, Shanxi Qishan Hejiacun xizhou muzang 陕西岐山贺家村西周墓葬 [The Western Zhou tombs from Hejia, Qishan, Shaanxi]. KG 1, 1976, 31-38.

Dai/Sun 1983

Dai Yingxin 戴应新/Sun Jiexiang 孙家祥, Shanxi Shenmu chutu xiongnu wenwu 陕西神木县出土匈奴文物 [Relics of the Hun excavated at Shenmu county in the Shaanxi Province]. WW 12, 1983, 23-30.

Daihai I 2000

Neimenggu wenwu kaogu yanjiusuo 内蒙古自治区文物考古研究所 (Ed.), Daihai kaogu (yi)-Laohushan wenhua yizhi fajue baogaoji 岱海考古(一)-老虎山文化遗址发掘报告集 [Archaeological Excavations at Daihai (I)-A site report on Laohushan culture] (Beijing 2000).

Daihai II 2001

Neimenggu wenwu kaogu yanjiusuo 内蒙古自治区文物考古研究所, Riben jingdu zhongguo kaoguxue yanjiusui 日本京都中国考古学研究会 (Ed.), Daihai kaogu (er)-zhongri daihai diqu kaocha yanjiu baogaoji 岱海考古(二)-中日岱海地区考察研究报告集 [Archaeological Excavations at Daihai (II)-A collection of Sino-Japanese archaeological reports and papers on sites in Daihai] (Beijing 2001).

Daihai III 2003

Neimenggu wenwu kaogu yanjiusuo 内蒙古自治区文物考古研究所 / Beijing daxue zhongguo kaoguxue yanjiu zhongxin 北京大学中国考古学研究中心/Juluo yanbian yu zaoqi wenming' ketizu “聚落演变与早期文明”课题组 (ed), Daihai kaogu (san)-Yangshao wenhua yizhi fajue baogaoji 岱海考古(三)-仰韶文化遗址发掘报告集 [Archaeological excavations at Daihai (III)-A site report on the Yangshao culture] (Beijing 2003).

Dani/Masson 1992

A. H. Danni/ V. M. Masson (ed.), History of Civilization of Central Asia (Paris 1992).

Debaine-Francfort 1995

C. Debaine-Francfort, Du Néolithique à L'AGE du bronze en Chine du nord-ouest La culture de Qijia et ses connexions (Paris 1995).

Ding G. X. 1981

Ding Guangxue 丁广学, Gansu Zhuanglangxian chutu de Siwa taoqi 甘肃庄浪县出土的寺

洼陶器 [The Siwa potteries unearthed from Zhuanglang county in Gansu]. KYW 2, 1981, 11-16.

DTJQH 1996

Guojia wenwuju 国家文物局 (Ed.), Zhongguo wenwu dituqi-Qinghai fence 中国文物地图集青海分册 [Atlas of Chinese Cultural Relics. Qinghai Fence-Maps of Chinese Relics--Qinghai] (Beijing 1996).

Domrös/Peng 1988

M. Domrös/Peng Gongbing, The climate of China (Berlin and Heidelberg 1988).

Dong X. L. 1996

Dong Xinlin 董新林, Gaotaihan wenhua yanjiu 高台山文化研究 [Research on the Gaotaihan culture]. KG 6, 1996, 52-67.

Dong Z. G. 1988

Dong Zhonggeng 董忠耿, Gansu Qingyang cheng bei faxian zhanguo shiqi zangma keng 甘肃庆阳城北发现战国时期葬马坑 [Horse pits of the Warring States found from the north of Qingyang city, Gansu]. KG 9, 1988, 852-854.

Donghuishan 98

Gansusheng wenwu kaogu yanjiusuo 甘肃省文物考古研究所, Minyue Donghuishan kaogu-Siba wenhua mudi de jieshi yu yanjiu 民乐东灰山考古-四坝文化墓地的揭示与研究 [Excavation Report on the Donghuishan Site in Minyue-Excavation and study on the cemetery of Siba culture] (Beijing 1998).

Du N. S. 1992

Du Naisong 杜迺松, Shi tan wo guo yuanshi shehui de tongqi 试谈我国原始社会的铜器 [Discussion on the bronzes of the Primary Society in China]. ZYWW 2, 1992, 93-96.

Du Z. S. 1993

Du Zhengsheng 杜正胜, Ouya caoyuan dongwu wenshi yu zhongguo gudai beifang mingzu zhi kaocha 欧亚草原动物纹饰与中国古代北方民族之考察 [Review on animal motifs in the Eurasian Steppes and ancient people in northern China]. NMGWK 1&2, 1993, 49-80.

Duandai 2000

Xiashangzhou duandai gongcheng zhuanjiazu 夏商周断代工程专家组, Xiashangzhou duandai gongcheng 1996-2000nian jieduan chengguo baogao/jianben 夏商周断代工程 1996-2000年阶段成果报告简本 [The Achievement Report of the Project on Dating the Xia Shang and Zhou Dynasties / Brief Version] (Beijing 2000).

DXF 1980

Dongxiafeng kaogudui 东下冯考古队, Shanxi xiaxian dongxiafeng yizhi dongqu zhongqu fajue jianbao 山西夏县东下冯遗址东区, 中区发掘简报 [A brief excavation report on the eastern and central zone of the Dongxiafeng site in Xia county, Shanxi]. KG 2, 1980, 97-107.

Ecke 1943

G. Ecke, Über einige Messer aus Anyang, Sinologische Arbeiten Vol.5, 78.

Egami Namio/Mizunari Seiichi 1935

Egami Namio 江上波夫/Mizunari Seiichi 水也清一, Uchi Moko Chojo Chitai 内蒙古.长城地带 [Inner Mongolia and the region of the Great Wall] (1935). Archaeologies Orientals. B

Series, Vol. I.

Erdly 1995

Miklos Erdly, Hun und Xiongnu type Caudron finds throughout Eurasia. In: Eurasian Studies Yearbook 67.

Erlitou 99

Zhongguo shehui kexueyuan kaogu yanjiusuo 中国社会科学院考古研究所 (ed.), Yanshi Erlitou-1959 nian-1978 nian kaogu fajue baogao 偃师二里头——1959年—1978年考古发掘报告 [Excavation at Erlitou, Yanshi during 1959-1978] (Beijing 1999).

Fan W. H. 1994

Fan Weihua 樊维华, Yer yizhi wenhua xingzhi chutan 也儿遗址文化性质初探 [Discussion on the cultural attribution of the Yer Site]. KG 1, 1994, 67-69.

Feng E. X. 1993

Feng Enxue 冯恩学, Zhongguo jingnei de beifangxi dongqu qingtongfu yanjiu 中国境内的北方系东区青铜釜研究 [Research on the bronze Kettle in the east region of Northern China]. In QGJ 93, 318-328.

Feng E. X. 2002

Feng Enxue 冯恩学, Eguo dong Xiboliya yu yuandong kaogu 俄国东西伯利亚与远东考古 [Archaeology of Russia, Eastern Siberia and the Far East] (Changchun 2002).

Fengxi 62

Zhongguo kexueyuan 中国科学院, Fengxi fajue baogao 沱西发掘报告 [Excavation Report at Fengxi] (Beijing 1962).

Fitzgerald-Huber 1995

Louis G. Fitzgerald-Huber, Qijia and Erlitou: the question of contacts with distant cultures. Early China 20, 1995, 60-61.

Gai S. L. 1965

Gai Shanlin 盖山林, Neimengguzizhiqu Zhungeerqi Sujigou chutu yipi tongqi 内蒙古自治区准格尔旗速机沟出土一批铜器 [One group of bronzes collected from Sujigou, Zhungerqi, Inner Mongolia]. WW 2, 1965, 44-46.

Gai S. L. 1986

Gai Shanlin 盖山林, Neimenggu Wumeng nanbu faxian de qingtongqi he tong yin 内蒙古乌盟南部发现的青铜器和铜印 [Bronze objects and seals found from the southern Wukezhaomeng, Inner Mongolia]. KG 2, 1986, 185-187.

Gao D. L. 1984

Gao Donglu 高东陆, Qinghaihu huanhu kaogu diaocha 青海湖环湖考古调查 [Archaeological survey around Qinghai Lake]. KG 3, 1984, 197-202.

Gao D. L. 1985a

Gao Donglu 高东陆, Tongdexian Bagouxiang Tuertan Majiayao wenhua Banshan leixing yizhi faxianji 同德县巴沟乡兔儿滩马家窑文化半山类型遗址发现记 [Excavation of the Banshan type of the Majiayao culture site at Tuertan, Tongde county]. QHKKH 4, 1985, 48-50.

Gao D. L. 1985b

Gao Donglu 高东陆, Tongren Zhamao Zongansi chutu de ji jian wenwu 同仁扎毛宗安寺出土的几件文物 [Several remains found from Zong'an Temple, Zhamao, Tongren]. QHKh 12, 1985, 48-49.

Gao D. L. 1993

Gao Donglu 高东陆, Luelun Kayue wenhua 略论卡约文化 [Discussion on Kayue culture]. KWL 3, 1993, 153-165.

Gao Q. X. 1958

Gao Quxun 高去寻, Yindai de yimian tongjing jiqi xiangguan zhi wenti 殷代的一面铜镜及其相关问题 [One Yin mirror and related questions]. LYY 29, 658-719.

Gao X. 1984

Gao Xue 高雪, Shanxi Qingjian xian you faxian Shangdai qingtongqi 陕西清涧县又发现商代青铜器 [Bronzes of the Shang Dynasty found again from the Qingjian county, in Shaanxi Province]. KG 8, 1984, 760-761.

Gao/Wu 1984

Gao Donglu 高东陆/Wu Ping 吴平, Qinghai jingnei de shiguanmu 青海境内的石棺墓 [Sarcophagus burials in Qinghai]. QHKh 6, 1984, 30-33.

Gao/Xu 1990

Gao Donglu 高东陆/Xu Shuzhen 许淑珍, Qinghai Huangyuan Mobula Kayue wenhua yizhi fajue jianbao 青海湟源莫不拉卡约文化遗址发掘简报 [Brief report on the Kayue culture site at Mobulake, in Huangyuan county, Qinghai]. KG 11, 1990, 1012-1016.

Gaocheng 85

Hebeisheng wenwu yanjiusuo 河北省文物研究所, Taixi at Gaocheng of Shang site 藁城台西商代遗址 [Shang site at Taixi, Gaocheng] (Beijing 1985).

GBJ 59

Guo Baojun 郭宝钧, Shanbiao zhen yu Liulige 山彪镇与琉璃阁 [Shanbiao town and Liulige] (Beijing 1959).

Ge S. B. 1982

Ge Sangben 格桑本, Qinghai Longwuhe liuyu kaogu diaocha 青海隆务河流域考古调查 [Archaeological survey in the Longwuhe region, Qinghai]. KYW 1, 1982, 4-9.

Ge S. B. 1982

Ge Sangben 格桑本, Qinghai Longwuhe liuyu kaogu diaocha 青海隆务河流域考古调查 [Survey of the Longwuhe region in Qinghai]. KYW 3, 1982, 4-9.

Ge S. B. 1999

Ge Sangben 格桑本, Guanyu Qinghai kaogu gongzuo de fazhan wenti 关于青海考古工作的发展问题 [On the development of archaeological work in Qinghai]. In: QHWUSHINIAN 99, 11-17.

Ge/Chen 1999

Ge Sangben 格桑本/Chen Hongmei 陈洪梅 (Ed.), Zongri yizhi wenwu jingcui lunshu xuanji 宗日遗址文物精粹论述选集 [Selection of the Elite Remains found in the Zongri Site] (Chengdu 1999), 132.

Ge/Hong 1990

Ge Sangben 格桑本/Hong Hai 洪海, Qinghai Minhe Hetaozhuang Shanjiatou mudi fajue jianbao 青海民和核桃庄山家头墓地发掘简报 [Brief report of the excavation at the Shanjiatou cemetery in Hetaozhuang, Minhe, Qinghai]. QHWW 5, 1990, 10-15.

Genito 1994

B. Genito, The archaeology of the Steppes: methods and strategies (Napoli 1994).

Gong G. Q. 1997

Gong Guoqiang 龚国强, Xinjiang diqu zaoqi tongqi luelun 新疆地区早期铜器略论 [Discussion on the early bronzes in the Xinjiang region]. KG 9, 1997, 7-20.

Gong Q. M. 1999

Gong Qiming 巩启明, Jiangzhai yizhi kaogu fajue de zhuaoshouhuo jiqi yiyi 姜寨遗址考古发掘的主要收获及其意义 [The main achievements and significance of the excavation at the Jiangzhai site]. Renwen zazhi 人文杂志 4, 1981, 119.

GSB 1959a

Gansusheng bowuguan 甘肃省博物馆, Gansu Weihe zhiliu Nanhe, Bangshahe, Zhanghe kaogu diaocha 甘肃渭河支流南河, 榜沙河, 漳河考古调查 [Survey of tributaries of the Wei River at Nan River, Bangsha River and Zhang River in Gansu]. KG 7, 1959, 326-328.

GSB 1959b

Gansusheng bowuguan 甘肃省博物馆, Gansu Xihanshui liuyu kaogu diaocha baogao 甘肃西汉水流域考古调查报告 [Survey report of the Xihanshui Valley in Gansu]. KG 3, 1959, 138-146.

GSB 1960a

Gansusheng bowuguan 甘肃省博物馆, Gansu gu wenhua yicun 甘肃古文化遗存 [The remains of ancient cultures in Gansu]. KGXB 2, 1960, 11-51.

GSB 1960b

Gansusheng bowuguan 甘肃省博物馆, Linxia Dahezhuang Qinweijia liangchū qijia wenhua yizhi fajue jianbao 临夏大何庄秦魏家两处齐家文化遗址发掘简报 [Excavation report on two Qijia culture sites at Dahezhuang, Qinwenjia in Linxia]. KG 3, 1960, 9-12.

GSB 1960c

Gansusheng bowuguan 甘肃省博物馆, Gansu Wuwei Niangniangtai yizhi fajue bagao 甘肃武威娘娘台遗址发掘报告 [Excavations of a Neolithic site at Huangniangniangtai, Wuwei county, Gansu]. KGXB 2, 1960, 53-71.

GSB 1963

Gansusheng bowuguan 甘肃省博物馆, Gansu Zhuangliangxian Liujiacun Siwa muzang 甘肃庄浪县柳家村寺洼墓葬 [The Siwa burials at Liujiacun village, Zhuanglang county, Gansu]. KG 1, 1963, 48.

GSB 1976

Gansusheng bowuguan 甘肃省博物馆, Gansu Lingtai liangzhou mudi 甘肃灵台县两周墓地 [Zhou burials at Lingtai county, Gansu]. KG 1, 1976, 38-48.

GSB 1978

Gansusheng bowuguan 甘肃省博物馆, Wuwei Niangniangtai yizhi disici fajue 武威娘娘台遗址第四次发掘 [Excavations of the fourth season (1975) at Huang-niang-niang-tai in Wuwei county]. KGXB 4, 1978, 421-447.

GSB 1979

Gansusheng bowuguan 甘肃省博物馆, Gansusheng wenwu kaogu gongzuo sanshinian 甘肃省文物考古工作三十年 [30 Years of Cultural Relics and Archaeology Work in Gansu]. In: Sanshinian 79, 139-153.

GSB 1980

Gansusheng bowuguan 甘肃省博物馆, Gansu Lingtai Qiaocun Qijia wenhua yizhi shijue jianbao 甘肃灵台桥村齐家文化遗址试掘简报 [Tentative excavation of the Qijia culture site at Qiao village, Lingtai, Gansu]. KYW 3, 1980, 22-24.

GSB 1983

Gansusheng bowuguan 甘肃省博物馆, Lanzhou Tugutai Machang wenhua mudi 兰州土谷台马厂文化墓地 [Machang culture cemetery at Tugulan, Gansu]. KGXB 2, 1983, 191-217.

GSB 1996

Gansusheng bowuguan 甘肃省博物馆, Gansu Jishishanxian Xinzhuangping Qijia wenhua yizhi diaocha 甘肃积石山县新庄坪齐家文化遗址调查 [Survey of the Qijia culture site at Xinzhuangping, Jishishan county in the Gansu Province]. KG 11, 1996, 46-53.

GSBG 1981

Gansusheng bowuguan wenwudui 甘肃省博物馆文物工作队, Gansu Yongdeng Yushugou de Shajing muzang 甘肃永登榆树沟的沙井墓葬 [Shajing culture graves at Yushugou in Yongdeng county, Gansu Province]. KYW 4, 1981, 34-36.

GSBG et al. 1984

Gansusheng bowuguan wenwudui 甘肃省博物馆文物工作队 et al., Gansu Yongchang Sanjiaocheng Shajing wenhua yizhi diaocha 甘肃永昌三角城沙井文化遗址调查 [Survey of Shajing culture sites at Sanjiaocheng, Yongchang, Gansu]. KG 7, 1984, 598-601.

GSCT 79

Gansusheng bowuguan 甘肃省博物馆, Gansu caitao 甘肃彩陶 [Painted Pottery in Gansu] (Beijing 1979).

GSG et al. 1988

Gansusheng wenwu kaogu gongzuodui 甘肃省文物考古工作队 et al., Gansu Linxia Lianhuatai Xindian wenhua muzang fajue baogao 甘肃临夏莲花台辛店文化墓葬发掘报告 [Excavation of Xindian culture cemetery at Lianhuatai, Linxia, Gansu]. WW 3, 1988, 7-20.

GSG 1986

Gansusheng wenwu kaogu gongzuodui 甘肃省文物考古工作队, Gansu Chongxin Yujiawan fajue jianbao 甘肃崇信于家湾周墓发掘简报 [Brief report on the excavation of Zhou burials at Yujiawan, Chongxin, Gansu]. KYW 1, 1986, 1-7.

GSG 1987b

Gansusheng wenwu kaogu gongzuodui 甘肃省文物考古工作队, Gansu Gangu Maojiaping yizhi fajue baogao 甘肃甘谷毛家坪遗址发掘报告 [Excavation at Maojiaping, Gangu, Gansu]. KGXB 3, 1987, 359-395.

GSG et al. 1984

Gansusheng wenwu kaogu gongzuodui 甘肃省文物考古工作队 etal, Gansu Dongxiang Linjia yizhi fajue baogao 甘肃东乡林家遗址发掘报告 [Report on the excavation at Linjia, Dongxiang, Gansu]. KGXJ 4, 1984, 111-161.

GSG et al. 1987

Gansusheng wenwu kaogu gongzuodui 甘肃省文物考古工作队, Gansu Xihe Lanqiao Siwa wenhua muzang 甘肃西河栏桥寺洼文化墓葬 [Siwa culture burials at Lanqiao, Xihe, Gansu]. KG 8, 1987, 678-891.

GSY 1990

Gansusheng wenwu kaogu yanjiusuo 甘肃省文物考古研究所, Yongchang Sanjiaocheng yu Hamadun Shajing wenhua yicun 永昌三角城与蛤蟆墩沙井文化遗存 [Remains of the Shajing culture at Sanjiaocheng and Hamadun, Yongchang]. KGXB 2, 1990, 205-236.

GSY 1994

Gansusheng wenwu kaogu yanjiusuo 甘肃省文物考古研究所, Xindian Linxia Yanchang yizhi faxian de Xindian wenhua taoqi 甘肃临夏盐场遗址发现的辛店文化陶器 [The Xindian culture potteries found from Yanchang, Linxia, Gansu]. KYW 3, 1994, 1-15.

Gu W. H. 1978

Gu Wenhua 顾文华, Qinghai Buha hepan de qingtongqi muzang 青海布哈河畔的青铜器墓葬 [On the bronze burials near the Buha River in Qinghai]. KG 1, 1978, 69-70.

Gu Z. J. 1986

Gu Zhijie 顾智界, Eerduosi tongtie fu de xingtai fenxi 鄂尔多斯铜铁釜的形态分析 [Study on the forms of Ordos bronze (iron) kettle]. BFWW 3, 1986, 19-22.

Guo B. J. 1951

Guo Baojun 郭宝钧, 1951nian Yinxu fajue baogao 1951年殷墟发掘报告 [Excavation Report at Yinxu in 1951]. ZKXB 1, 1951, 1-61.

Guo B. J. 1964

Guo Baojun 郭宝钧, Junxian Xincun 浚县辛村 [Xincun in Jun county] (Beijing 1964).

Guo D. S. 1987

Guo Dashun 郭大顺, Shilun Weiyngzi leixing 试论魏营子类型 [Tentative discussion on Weiyngzi type]. KWL 1, 1987, 79-98.

Guo D. S. 1993

Guo Dashun 郭大顺, Liaohe liuyu beifangshi qingtongqi de faxian yu yanjiu 辽河流域北方式青铜器的发现与研究 [The discovery and study of Northern Bronzes in Liaohe river region]. NMGWK 1&2, 1993, 23-28.

Guo D. S. 1994

Guo Dashun 郭大顺, Chifeng diqu zaoqi yetong kaogu suixiang 赤峰地区早期冶铜考古随想 [Thoughts about early smelting bronze in the Chifeng region]. NMGWKW 2, 1994, 280-288.

Guo M. L. 1976

Guo Moruo 郭沫若, Zhongguo shigao 中国史稿 [Papers on Chinese History] (Beijing 1976).

Guo S. X. 1992

Guo Suxin 郭素新, Neimenggu faxian de Eerduosi shi qingtongqi gaishu 内蒙古发现的鄂尔多斯式青铜器概述 [Summary of the Ordos-style bronzes found from Inner Mongolia]. NMGWK 1&2, 1993, 34-38.

Guo S. X. 1993

Guo Suxin 郭素新, Shilun Handai Xiongnu wenhua tezheng 试论汉代匈奴文化的特征 [Re-discussion on the origin of the Ordos bronzes]. NMGWK 1&2, 1993, 89-96.

Guo W. 1999

Guo Wu 郭物, Qingtong Fu de qi yuan jiqi zai ouya dalu de chuanbo 青铜镬的起源及其在欧亚大陆的传播 [The origin of the bronze cooking ware-Fu and its diffusion in Eurasia], master thesis (Beijing 1999).

Guo W. 2002

Guo Wu 郭物, Ouya caoyuan kaogu yanjiu gaishu 欧亚草原考古研究概述 [Review on the research on the Eurasian Steppe]. XYYJ 1, 2002, 103-108.

Guo Y. 1962

Guo Yong 郭勇, Shilou Houlanjiagou faxian Shangdai qingtongqi jianbao 石楼后兰家沟发现商代青铜器简报 [Bronzes of the Shang and Zhou found from Houlanjiagou, Shilou]. WW 4/5, 1962, 33-34.

Guo Z. Z. 1997

Guo Zhizhong 郭治中, Neimenggu dongbuqu xinshiqi-qingtong shidai kaogu faxian yu yanjiu 内蒙古东部区新石器-青铜时代的考古发现与研究 [Archaeological discoveries and studies of the Neolithic-Bronze Age in east Inner Mongolia]. NMGWKW 2, 1997, 13-23.

Guo Z. Z. 2000

Guo Zhizhong 郭治中, Shuiquan mudi jiqi xiangguan wenti zhi tansuo 水泉墓地及相关问题之探索 [Related questions and research on the Shuiquan Cemetery].

Guoguo 59

Zhongguo kexueyuan 中国科学院, Shangcunlin Guoguo mudi 上村岭虢国墓地 [Guo State Cemetery at Shangcunlin] (Beijing 1959).

GYB 1992

Guyuan bowuguan 固原博物馆, Ningxia Guyuan Lvpingcun faxian yizuo dongzhou mu 宁夏固原吕坪村发现一座东周墓 [One Eastern Zhou grave discovered from Lvping village, Guyuan, Ningxia]. KG 5, 1992, 469-470.

GYG 1983

Guyuanxian wenwu gongzuozhan 固原县文物工作站, Ningxia Guyuanxian Xizhoumu qingli jianbao 宁夏固原县西周墓清理简报 [Excavation Report on the Western Zhou burials at Guyuan county, Ningxia]. KG 11, 1983, 982-984.

GZB 1994

Gannan Zangzu zizhizhou bowuguan 甘南藏族自治州博物馆, Gansu Zhuoniye yizhi shijue jianbao 甘肃卓尼也儿遗址试掘简报 [Tentative excavation at Zhuoniye, Gansu]. KG 1, 1994, 66-69.

GZW 1994

Gannanzangzu zizhizhou wenhuaju 甘南藏族自治州文化局, Gansu Zhuonixian Nalangxiang kaogu diaocha jianbao 甘肃卓尼县纳浪乡考古调查简报 [Brief report on the excavation at Nalang village, Zhuoni county, Gansu]. KG 7, 1994, 587-599.

Hamada Kosaku/Mizuno Seiichi 1938

Sekiho Kosanko: Manshu kogu Netkasho Sekho Kosanko senshi iseki [Prehistoric sites at Hongshanhou, Chifeng], Archaeologia Orientalis. Series A. Vol. VI (Tokyo 1938).

Han J. G. 1966

Han Jiagu 韩嘉谷, Hebei Dachang Huizu zizhixian Datuotou yizhi fajue jianbao 河北大厂回族自治县大坨头遗址发掘简报 [Brief report on the excavation of the Datuotou site in Dachang, Hebei]. KG 1, 1966, 8-13.

Han J. G. 1981

Han Jiagu 韩嘉谷, Jing jin diqu Shangzhou shiqi gu wenhua fazhan de yidian xiansuo 京津地区商周时期古文化遗址发展的一点线索 [Some clues on the development of the ancient cultures in the Beijing and Tianjin regions during the Shang and Zhou period]. Nianhui 3, 1984, 220-229.

Han J. G. 1991a

Han Jiagu 韩嘉谷, Huabianli xunzong-tan woguo beifang changcheng wenhuadai de xingcheng 花边鬲寻踪-谈我国北方长城文化带的形成 [Seeking the trace of the lace tripod-Li---discussion on the formation of the cultural belt along the Great Wall]. In: NMGDBQ, 41-52.

Han J. G. 1991b

Han Jiagu 韩嘉谷, Lue lun zhongguo beibu changcheng didai faxian de dongwuwen qingtong shipai 略论中国北部长城地带发现的动物纹青铜饰牌 [Discussion on the animal-style bronze plaques found north of the Great Wall]. WWCQ 4, 1991, 1-34.

Han J. G. 1992

Han Jiagu 韩嘉谷, Datuotou wenhua taoqi qun qianxi 大坨头文化陶器群浅析 [On the pottery assemblages of the Datuotou culture]. Nianhui7, 1992, 294-306.

Han J. G. 1994

Han Jiagu 韩嘉谷, Cong Jundushan Dongzhou mu tan Shanrong, Hu, Donghu de kaoguxue wenhua guishui 从军都山东周墓谈山戎, 胡, 东胡的考古学文化归属 [Discussion on the cultural ascription of Shanrong, Hu, Donghu in light of the Jundushan tombs during Eastern Zhou period]. NMGWKW 1, 1994, 336-347.

Han J. G. 1996

Han Jiagu 韩嘉谷, Changcheng didai qingtong duanjian de kaoguxue wenhua guishu he zushu 长城地带青铜短剑的考古学文化归属和族属 [On the cultural ascription of short bronze swords in the Great Wall region and its attributive people]. Nianhui 8, 1996, 157-174.

Han J. G. 1997

Han Jiagu 韩嘉谷, Huan bohai gu wenhua puxi he quxi leixing shuo 环渤海古文化谱系和区系类型说 [Discussion on the pedigree, region, and complex of the ancient cultures around the Bohai]. Nianhui 9, 1997, 20-34.

Han K. X. 1995

Han Kangxin 韩康信, Ningxia Pengbao Yujiazhuang mudi rengu zhongxi tedian zhi yanjiu 宁夏彭堡于家庄墓地人骨种系特点之研究 [Study on the ethnic characteristics of the human bones found at the Yujiazhuang cemetery, Pengbao, Ningxia], KGXB 1, 1995, 109-125.

Han K. X. 2000

Han Kangxin 韩康信, QinghaiXunhua Ahatela shan gu mudi rengu yanjiu 青海循化阿哈特拉山古墓地人骨研究 [Research on the skeletons from ancient burials at Ahatela in Xunhua county, Qinghai]. KGXB 3, 2000, 395-420.

Han R. B. 1994

Han Rubin 韩汝玢, Jinnianlai yejin kaogu de yixie jinzhān 近年来冶金考古的一些进展 [Some development of Archaeometallurgy in recent years]. YJL 6, 1994, 6-9.

Han R. B. 2002

Han Rubin 韩汝玢, Recent Archaeometallurgy Research on Non-ferrous Metals at the Institute of Historical Metallurgy, USTB. History of Chinese Metallurgy, 2002, 71-77.

Han R. B. et al. 1993

Han Rubin 韩汝玢 et al., Biaomian fuxi Eerduosi qingtongqi shipin de yanjiu 表面富锡鄂尔多斯青铜器饰品的研究 [Research on the Ordos Bronze ornaments with tin-enriched surface]. WW 9, 1993, 80-96.

Han X. M. 1994

Han Xiaomang 韩小忙, Lue lun Ningxia jing nei de tudongmu 略论宁夏境内的土洞墓 [Discussion on the earth pits inside Ningxia]. KG 11, 1994, 1028-1036.

Han Y. L. 1996

Han Yuling 韩玉玲, Tan Erlitou wenhua shiqi de qingtong yezhuye 谈二里头文化时期的青铜冶铸业 [On the smelting and casting of bronzes during the Erlitou culture period]. ZYWW 2, 1992, 101-102.

Han/Ji 1993

Han Jiagu 韩嘉谷/Ji Liemin 纪烈敏, Ji xian Zhangjiayuan yizhi qingtong wenhua yicun zongshu 藪县张家园遗址青铜文化遗存综述 [Summary of the bronzes from the Zhangjiayuan site in Ji county]. KG 4, 1993, 355-364.

Han/Ke 1988

Han Rubin 韩汝玢 / Ke Jun 柯俊, Jiangzhai diyiqi wenhua chutu huangtong zhipin de jianding baogao 姜寨第一期文化出土黄铜制品的鉴定报告 [Appraisal report on the brass artifacts unearthed from Jiangzhai culture I]. In: Jiangzhai 88, 544-548.

Han/Li 1996

Han Rubin 韩汝玢 / Li Xiuhui 李秀辉, Eerduosi tongqi zhizuo jishu de chubu yanjiu 鄂尔多斯青铜器制作技术的初步研究 [Primary research on the manufacturing techniques of the Ordos bronzes]. Nianhui 8, 1996, 104-114.

Han/Pan 1984

Han Kangxin 韩康信 / Pan Qifeng 潘其凤, Zhongguo gudai renzhong chengfen yanjiu 中国古代人种成分分析 [Research on Human Ethnicity in Ancient China]. KGXB 2, 1984, 245-263.

Hang Y. P. 2000

Huang Yunping 黄蕴平, Zhukaigou yizhi shougu de jianding yu yanjiu 朱开沟遗址兽骨的鉴定与研究 [Identification and research of the animal bones found in the Zhukaigou site]. In: Zhukaigou 2000, 400-421.

Hao W. B. 1996

Hao Weibin 郝维彬, Neimenggu Kulunqi Nanpaoziya Xiajiadian xiaceng wenhua yizhi diaocha jianbao 内蒙古库伦旗南泡子崖夏家店下层文化遗址调查简报 [The brief report on the survey of the Lower Xiajiadian culture site at Nanpaoziya, Kulunqi, Inner Mongolia]. BFWW 3, 1996, 11-14.

Harada Yoshito 1931

Harada Yoshito, Minami Manshu Rotetsu sanroku Kan oyobi Kan izen iseki [Muyangcheng: Han and pre-Han sites at the foot of Mount Laotie in south Manchuria]. Archaeologia Orientalis. Series A. Vol. II. 1931.

HBKW 98

Hebeisheng wenwu yanjiusuo 河北省文物研究所 Ed., Hebei sheng kaogu wenji 河北省考古文集 [Papers on Archaeology in the Hebei Province] (Beijing 1998).

HBW 1983

Hebeisheng wenwu yanjiusuo 河北省文物研究所, Hebei Luannan xian Dongzhuangdian yizhi diaocha 河北省滦南县东庄店遗址调查 [Survey at Dongzhuangdian, in Luannan county, Hebei Province]. KG 9, 1983, 775-778.

HBW 1984

Hebeisheng wenwu yanjiusuo 河北省文物研究所, Tangshan shi gu ye Shangdai yizhi 唐山市古冶商代遗址 [Ancient smelting sites during the Shang period in Tangshan county]. KG 9, 1984, 769-778.

HBW 1985

Hebeisheng wenwu yanjiusuo 河北省文物研究所, Hebei Lulong xian Donghan Gezhuang yizhi 河北卢龙县东闫各庄遗址 [The Gezhuang site in Donghan, Lulong county, Hebei]. KG 11, 1985, 980-984.

HBW 1992

Hebeisheng wenwu yanjiusuo 河北省文物研究所, Hebei laishui jianxin cun yizhi fajue baogao 河北涞水渐新村遗址发掘报告 [Excavation at the Jianxin village, Laishui, Hebei]. WWCQ supplement, 1992.

HBW 1998

Hebeisheng wenwu yanjiusuo 河北省文物研究所, Hebei Fengning tuchengzhen shiguanmu diaocha 河北丰宁土城镇石棺墓调查 [Survey of sarcophagus burials at Tucheng, Fengning, Hebei]. In: HBKW 98, 127-132.

HBW et al. 1992

Hebeisheng wenwu yanjiusuo 河北省文物研究所 et al, Hebeisheng Renqiushi yabazhuang yizhi fajue baogao 河北省任丘市哑吧庄遗址发掘报告 [Excavation at the Yabazhuang site, Renqiu Town, Hebei Province]. WWCQ supplement, 1992.

HBWG 1959

Hebeisheng wenwu guanli wenyuanhui 河北省文物管理委员会, Hebei Tangshan shi

Dachengshan yizhi fajue baogao 河北唐山市大城山遗址发掘报告 [Excavation at the Dachengshan site, in Tangshan county, Hebei]. KGXB, 2, 1959, 17-35.

HBWW 1962

Hebeisheng wenhuaju wenwu gongzuo dui 河北省文化局文物工作队, Hebei Qinglong xian Chaodaogou faxian yipi qingtongqi 河北青龙县抄道沟发现一批青铜器 [One group of bronzes discovered at Chaodaogou, Qinglong county, Hebei]. KG 12, 1962, 644-645.

HBWW 1966

Hebei sheng wenhuaju wenwu gongzuodui 河北省文化局文物工作队, Hebei Huailai Beixinbao zhanguo mu 河北怀来北辛堡战国墓 [The Warring States tombs at Beixinbao, Huailai, Hebei]. KG 5, 1966, 231-242.

HBWX 1980

Hebeisheng bowuguan 河北省博物馆/Wenwu guanlichu 文物管理处 ed., Hebeisheng chutu wenwu xuanji 河北省出土文物选集 [Collection of the Cultural Relics unearthed at the Hebei Province] (Beijing 1980).

He B. D. 1975

He Bingdi, [The cradle of the east: an inquiry into the indigenous origins of techniques and ideas of Neolithic and early historic China, 5000-1000 B.C.] (Hongkong 1975).

He J. N. 2001

He Jianian 何嘉年, Neimenggu Liangcheng xian Yinniugou mudi 1997 nian fajue chutu rengu yanjiu 内蒙古凉城县饮牛沟墓地 1997 年发掘出土人骨研究 [Study on the bones from the Yinniugou cemetery in Liangcheng county, Inner Mongolia excavated in 1997]. KG 11, 2001, 80-86.

He Z. Y. 1982

He Zhengya 和正雅, Cong Panjialiang mudi de fajue shitan dui Kayue wenhua de renshi 从潘家梁墓地的发掘试谈对卡约文化的认识 [Discussion of the Kayue culture based on the excavation at Panjialiang cemetery]. QHKH 12, 1981, 30-37.

He/Jin/Wang 2002

He Tangkun 何堂坤/ Jin Fengyi 靳枫毅/Wang Jihong 王继红, Beijing shi Yanqing xian Jundushan shanrong qingtong hejin jishu chubu yanjiu 北京市延庆县军都山山戎青铜合金技术初步研究 [A Primary study on the bronze alloying technique of Shanrong in Jundu Mountain, Yanqing]. BFWW 2, 2002, 18-23.

He/Liu 1993

He Yong 贺勇 / Liu Jianzhong 刘建中, Hebei Huailai Ganzibao faxian de chunqiu mu 河北怀来甘子堡发现的春秋墓群 [Spring-autumn burials discovered in Ganzibao, Huailai, Hebei]. WWCQ 2, 1993, 23-40.

He/Zheng/Zhao/Cao

He Xianwu 何贤武/Zheng Chen 郑辰/Zhao Changlin 赵常琳/Cao Guilin 曹桂林, Liaoning Faku xian Wanliujie yizhi fajue 辽宁法库县湾柳街遗址发掘 [Excavation at Wanliujie, Faku county, Liaoning]. KG 12, 1989, 1076-1086.

Hei/Zhu 1975

Hei Guang 黑光 / Zhu Jiexuan 朱捷元, Shanxi Suide Yantoucun faxian yipi jiaoqiang

shangdai tongqi 陕西绥德塬头村发现一批窖藏商代铜器 [One hoard of Shang bronzes found at Yantou village, Suide, Shaanxi]. WW 2, 1975, 82-87.

HHGS 1959

Huanghe shuiku kaogudui gansu fendui 黄河水库考古队甘肃分队, Gansu Yongjingxian Zhangjiazui yizhi fajue jianbao 甘肃永靖县张家嘴遗址发掘简报 [Brief report on the excavation at Zhangjiazui, Yongjing county, Gansu]. KG 4, 1959, 181-184.

HHGS 1960

Huanghe shuiku kaogudui Gansu fendui 黄河水库考古队甘肃分队, Linxia Dahezhuang, Qinweijia liangchu qjia wenhua yizhi fajue jidanba 临夏大何庄, 秦魏家两处齐家文化遗址发掘简报 [Brief report on the excavation of two Qijia culture sites at Dahezhuang and Qinweijia]. KG 3, 1960, 9-12.

HHGS 1961

Huanghe shuiku kaogudui Gansu fendui 黄河水库考古队甘肃分队, Gansu Linxia Majiawan yizhi fajue jianbao 甘肃临夏马家湾遗址发掘简报 [Excavation report on the Majiawan site in Linxia county, Gansu Province]. KG 11, 1961, 609-611.

HHGS 1962

Huanghe shuiku kaogudui Gansu fendui 黄河水库考古队甘肃分队, Gansu Linxia Jijiachuan yizhi fajue jianbao 甘肃临夏姬家川遗址发掘简报 [Brief report of Jijiachuan, Linxia, Gansu]. KG 2, 1962, 69-71.

HHGS 1965

Huanghe shuiku kaogudui Gansu fendui 黄河水库考古队甘肃分队, Huanghe shangyou Yanguoxia yu Bapenxia kaogu diaochaji 黄河上游盐锅峡与八盆峡考古调查记 [Survey at Yanguoxia and Bapenxia of upper Yellow River]. KG 7, 1965, 321-325.

HHWWZ 1991

Qinghaisheng wenwuzhi bianji weinhuiyuan 青海省文物志编辑委员会, Huangzhongxian Huangyuan xian wenwuzhi 湟中县湟源县文物志 [Cultural relics literature of Huangzhong and Huangyuan county] (Xining 1991).

Ho 1975

Ho Pengti, The Cradle of the East: An Inquiry into the Indigenous Origin of Techniques and Ideas of Neolithic and Early Historic China, 5000-1000 B.C. (Hongkong 1975).

Hong H. 1999

Hong Hai 洪海, Huanjing yinsu yu kaoguxue yanjiu 环境因素与考古学研究 [Environmental element and archaeological research]. In: QHWUSHINIAN 99, 229-235.

Hong/Ge 1990

Hong Hai 洪海/Ge Sangben 格桑本, Shilun Shanjiatou leixing 试论山家头类型 [Discussion on the Shanjiatou type]. QHWW 5, 25-34.

Hongshanhou 1938

滨田耕作 Hamada Kosaku/水也清一 Mizunari Seiichi, Chifeng Hongshanhou 赤峰红山后 [Hongshanhou, Chifeng].

Hu Q. Y. 1980

Hu Qianying 胡谦盈, Shilun Qijia wenhua de butong leixing jiqi yuanliu 试论齐家文化的不同

同类型及其源流 [Discussion on the different types and origin of the Qijia culture]. KYW 3, 1980, 77-82.

Hu X. J. 1996

Hu Xiaojun 胡小军, Jianzha xian Zhigang Lakaxiang Qijia wenhua yizhi fajue jianbao 尖扎县直岗拉卡乡齐家文化遗址发掘简报 [Brief report on the excavation in Lakaxiang of the Qijia culture in Zhigang, Jianzha]. QHWW 10, 1996, 87-89.

Hua J. M. 1991

Hua Jueming 华觉明, Lun Zhongguo Yejinshu de qi yuan 论中国冶金术的起源 [On the origins of metallurgy in China]. ZKY, 1991, 364-368.

Hua J. M. 1999

Hua Jueming 华觉明, Zhongguo gudai jinshu jishu 中国古代金属技术 [Ancient Chinese metallurgical techniques] (Beijing 1999).

Huang K. Y. 1992

Huang Keying, Tantan zhongguo zaoqi tongqi de duanzao zhuzao jishu 谈谈中国早期铜器的锻造, 铸造技术 [Discussion on the forging and casting technique of early Chinese bronzes]. ZYWW 2, 1992.

Huangzhongxianzhi 1990

Huangzhong Xian di fang zhi bian zuan wei 湟中县志编委会 (Ed.), Huangzhong xianzhi 湟中县志 [county annals of Huangzhong] (Xining 1990).

Huanjing 99

Zhang Zonghu 张宗祜 et al, Zhongguo beifang wan gengxinshi yilai dizhi huanjing yanhua yu weilai shengcun huanjing bianhua qushi yuce 中国北方晚更新世以来地质环境演化与未来生存环境变化趋势预测 [On Evolution of Geological Environment in Northern China since the Late Pleistocene and Forecast on the Prospective Changes] (Beijing 1999).

HUBB 1976

Hubeisheng bowuguan 湖北省博物馆, 1963nian Hubei Huangpi Panlongcheng Shangdai yizhi de fajue 1963年湖北黄陂盘龙城商代遗址的发掘 [Excavation of the Shang site at Panlongcheng, Huangpi, Hubei in 1963]. WW 1, 1976, 49-59.

Jacobson 1993

E. Jacobson, The Deer Goddess of Ancient Siberia: a Study in the Ecology of Belief (Leiden 1993).

Jettmar 1950

K. Jettmar, The Karasuk culture and its south-eastern affinities. BMFEA 22, 1950, 83-126.

Ji L. M. 2002

Ji Liemin 纪烈敏, Yanshan nanlu qingtong wenhua de leixing puxi jiqi yanbian 燕山南麓青铜文化的类型谱系及其演变 [Pedigree and evolution of the bronze cultures south of the Yanshan]. BJKY 1, 2002.

Ji N. J. 1994

Ji Naijun 姬乃军, Shanxi Yanchang chutu yipi wan Shan qingtongqi 陕西延长出土一批晚商青铜器 [Bronzes of the late Shan period found at Yanchang, Shaanxi]. KYW 2, 1994, 27-28.

Jia H. E. 1984

Jia Hong'en 贾鸿恩, Wengniuteqi Dapaozi Qingtong duanjian mu 翁牛特旗大泡子村青铜短剑墓 [The tomb with bronze dagger at Dapaozi, Wengniutei]. WW 2, 1984, 50-54.

Jiang G. 2006

Jiang Gang 蒋刚, Taihangshan liangyi beifang qingtong wenhua yu Xia Shang Xizhou wenhua de hudong guanxi 太行山两翼北方青铜文化与夏商西周文化的互动关系 [The interactive relations between the Northern bronze cultures along the Taihang Mountain and the Xia, Shang and Western Zhou cultures] (Changchun 2006). Doctoral dissertation, not yet published.

Jiangzhai 88

Xi'an Banpo bowuguan 西安半坡博物馆, Jiangzhai xinshiqi shidai yizhi fajue baogao 姜寨-新石器时代遗址发掘报告 [Jiangzhai-excavation at the Neolithic site Jiangzhai by the excavation group] (Beijing 1988).

Jin F. Y. 1982, 1983

Jin Fengyi 靳枫毅, Lun zhongguo dongbei diqu han quren qingtong duanjian de wenhua yicun 论中国东北地区含曲刃青铜短剑的文化遗存 [On the cultural remains of a short sword with curved blade in northeast of China]. KGXB 4, 1982, 387-426; KGXB 1, 1983, 39-54.

Jin F. Y. 1985

Jin Fengyi 靳枫毅, Ningchengxian xin faxian de Xiajiadian shangceng wenhua muzang yiji xiangguan yiwu de yanjiu 宁城县新发现的夏家店上层文化墓葬以及相关遗物的研究 [New discoveries of the Upper Xiajiadian culture tombs at Ningcheng city and related research on the remains]. WWZC 9, 1985, 23-59.

Jin F. Y. 1987

Jin Fengyi 靳枫毅, Xiajiadian shangceng wenhua jiqi zhushu wenti 夏家店上层文化及其族属问题 [The Upper Xiajiadian culture and its related clan]. KGXB 2, 1987, 177-208.

Jin F. Y. 1988

Jin Fengyi 靳枫毅, Dalinghe liuyu chutu de qingtong shidai yiwu 大凌河流域出土的青铜时代遗物 [The Bronze Age remains found in the Dalinghe valley]. WW 11, 1988, 24-36.

Jin F. Y. 1990

Jin Fengyi 靳枫毅, Lijing wunian jianku diaocha yu fajue-Beijing Jundushan Dongzhou Shanrong(山戎) wenhua kaogu qude zhongyao chengguo 历经五年艰苦调查与发掘-北京军都山东周山戎文化考古取得重要成果 [Great archaeological achievement on the Shanrong culture during the Eastern Zhou period at Jundushan, Beijing based on five years of survey and excavation]. BJKG 3, 1990.

Jin F. Y. 1991

Jin Fengyi 靳枫毅, Jundushan Shanrong wenhua mudi zangzhi yu zhuyao qiwu tezheng 军都山山戎文化墓地葬制与主要器物特征 [The burial manners and characteristics of most wares belonging to the Shanrong culture graves in Jundushan]. LHW 1, 1991, 61-73.

Jin F. Y. 2001

Jin Fengyi 靳枫毅, Jundushan Yuhuangmiao mudi de tezheng jiqi zushu wenti 军都山玉皇庙墓地的特征及其族属问题 [Characteristics and folk attribution of the Yuhuangmiao cemetery

in Jundushan]. In: SK 2001, 194-214.

Jin X. 1989

Jin Yue 金学, Zhongguo Shangdai qianqi qingtongqi fenqi 中国商代前期青铜器分期 [Periodization of the Early Shang bronze vessels]. KGXJ 6, 1989, 224-254.

Jin X. S. 1957

Jin Xueshan 金学山, Xi'an Banpo de zhanguo muzang 西安半坡的战国墓葬 [Warring States burials in Banpo, Xi'an]. KGXB 3, 1957, 63-88.

Jin Z. Y. 2000

Jin Zhengyao 金正耀, Erlitou qingtongqi de ziran kexue yanjiu yu xia wenming tansuo 二里头青铜器的自然科学研究与夏文明探索 [Scientific Research on the bronzes of the Erlitou culture and exploration of the Xia civilization]. WW 1, 2000, 56-64.

Jin/Wang 2001

Jin Fengyi 靳枫毅/Wang Jihong 王继红, Shanrong wenhua suo han Yan yu zhongyuan wenhua yinsu fenxi 山戎文化所含燕与中原文化因素分析 [Analysis on the element of the Yan and central plain culture inside of the Shanrong culture]. KGXB 1, 2001, 43-72.

JMHK 1988

Jumahe kaogudui 拒马河考古队, Hebei Yi xian Laishui gu yizhi shijue baogao 河北易县涞水古遗址试掘报告 [Tentative excavation at the Laishui site, Yi county, Hebei]. KGXB 4, 1988, 421-453.

JPW et al. 1983

Jianpingxian wenhuaguan 建平县文化馆/Chaoyang diqu bowuguan 朝阳地区博物馆, Liaoning Jianpingxian de qingtong shidai muzang ji xiangguan wenwu 辽宁建平县的青铜时代墓葬及其相关遗物 [The Bronze Age tombs and related remains found in Jianping county, Liaoning Province]. KG 8, 1983, 679-695.

JW 1985

Ji xian wenwu gongzuozhan 吉县文物工作站, Shanxi Ji xian chutu Shangdai qingtongqi 山西吉县出土商代青铜器 [Bronzes of the Shang Dynasty found from Ji county, Shanxi Province]. KG 9, 1985, 848-849.

Karlgren 1945

B. Karlgren, Some weapons and tools of the Yin Dynasty. BMFEA 17, 1945, 44.

Ke J. 1987

Ke Jun 柯俊, The development of metal technology in ancient China. In: Chen 1987, 225-243.

Keightley 1983

D. Keightley (ed.), The Origins of Chinese Civilization, Studies on China 1 (Berkeley and London, 1983).

Kexueshis 90

Du Shilan 杜石然 (ed.), Di san jie guoji zhongguo kexueshi tanlunhui lunwenji 第三届国际中国科学史讨论会论文集 [Collected work from the third international symposium on Chinese science history] (Beijing 1990).

KGB 1989

Kaogu bianjibu 《考古》编辑部, Zhongguo wenming qi yuan zuotanhui jiyao 中国文明起源座谈会纪要 [Summary of the symposium on the origin of Chinese civilization]. KG 12, 1989, 1110-1120.

KGXYJ 93

Kaoguxue yanjiu 考古学研究 [A study on archaeology] (Xi'an 1993).

KLJ21 98

Beijing daxue kaoguxuexi 北京大学考古学系 (Ed.), "Yingjie 21 shiji de zhongguo kaoguxue" guoji xueshu taolunhui lunwenji "迎接二十一世纪的中国考古学"国际学术讨论会论文集 [Proceedings of the International Conference on Archaeology enters the twenty-first Century] (Beijing 1998).

Kuashiji 2000

Zhang Zhongpei 张忠培/Xu Zhuoyun 许倬云, Zhongguo kaoguxue kuashiji de huigu yu qianzhan 中国考古学跨世纪的回顾与前瞻 [The review on and prediction of the Chinese archaeology during the trans-century] (Beijing 2000).

LBQ 98

Li Boqian 李伯谦, Zhongguo Qingtong uwenhua jiegou tixi yanjiu 中国青铜文化结构体系研究 [Studies on the Structural System of Chinese Bronze cultures] (Beijing 1998).

LFW et al. 1999

Langfang shi wenwu guanlisuo 廊坊市文物管理所 et al, Hebei Xianghe xian Qinggongtai cun Xiajiadian xiaceg wenhua muzang 河北香河县庆功台村夏家店下层文化墓葬 [The Lower Xiajiadian culture burials at the Qinggongtai village, Xianghe county, Hebei]. WWCQ 6, 1999, 26-30.

LG 2004

Li Gang 李刚, Zhongguo beifang qingtongqi de ouya caoyuan wenhua yinsu 中国北方青铜器的欧亚草原文化因素 [The cultural elements of the bronzes of Northern China in the Eurasian Steppes] (Doctoral dissertation, Nanjing 2004).

Li J. 1929

Li Ji 李济, Yinshang Taoqi chulun 殷商陶器初论 [Primary discussion on the potteries in Yinshang]. In: Anyang fajue baogao 安阳发掘报告 Report on the excavation at Anyang I.

Li B. Q. 1981

Li Boqian 李伯谦, Dongxiafeng leixing de chubu fenxi 东下冯类型的初步分析 [Preliminary analysis of Dongxiafeng type]. ZYWW 1, 1981, 29-37.

Li B. Q. 1986

Li Boqian 李伯谦, Erlitou leixing de wenhua xingzhi yu zushu wenti 二里头类型的文化性质与族属问题 [On the cultural character and related clan of Erlitou type]. WW 6, 1996, 41-47.

Li B. Q. 1991

Li Boqian 李伯谦, Fengshuo chengguo xin de keti 丰硕成果新的课题 [Fruitful achievement and new topic]. In: NMGZN 91.

Li B. Q. 1994

Li Boqian 李伯谦, Zhangjiayuan shangceng laixing ruogan wenti yanjiu 张家园上层类型若干问题研究 [Some problems regarding the Upper Zhangjiayuan type]. KY 2, 1994, 131-143.

Li B. Q. 1998a

Li Boqian 李伯谦, Xianshang wenhua tansuo 先商文化探索 [Study on Pre-Shang culture]. In: LBQ 98, 78-90.

Li B. Q. 1998b

Li Boqian 李伯谦, Zhongguo qingtong wenhua de fazhan jieduan yu fenqu xitong 中国青铜文化的发展阶段与分区系统 [Stages and districts of bronze cultures in China]. In: LBQ 98, 1-13.

Li B. Q. 1998c

Li Boqian 李伯谦, Cong Lingshi Jingjie Shang mu de faxian kan Shanjin gaoyuan qingtong wenhua de guishu 从灵石旌介商墓的发现看晋陕高原青铜文化的归属 [On the ascription of the bronze cultures in the Jinshan Plateau in light of the discovery of the Shang tombs at Jingjie, Lingshi]. In: LBQ 98, 167-184.

Li B. Q. 2000

Li Boqian 李伯谦, Guanyu zaoqi Xia wenhua-cong Xiashangzhou wangcha gengdie yu kaoguxue wenhua bianqian de guanxi tanqi 关于早期夏文化-从夏商周王朝更迭与考古学文化变迁的关系谈起 [On the early Xia culture- the relations between the alternation of the Xia, Shang and Zhou dynasties and the changes of the archaeological cultures]. ZYWW 1, 2000, 11-14.

Li B. S. 1996

Li Baushan 李宝山, Shilun Ganqing diqu de zaoqi tongqi 试论甘青地区的早期铜器 青海师范大学学报 [On early bronzes in the Gansu and Qinghai regions]. Qinghai shifan daxue xuebao 青海师范大学学报 2, 1996, 115-118.

Li F. et al.1989

Li Fan 李璠 et al., Gansusheng Minlexian Donghuishan xinshiqi yizhi gu nongye yicun xin faxian 甘肃省民乐县东灰山新石器遗址古农业遗存新发现 [New discoveries of the ancient remains of agriculture in the Neolithic site at Donghuishan, Minle county, Gansu Province]. NYKG 1, 1989, 56-69.

Li F. et al.1993

Li Fei 李非 et al., Huluhe liuyu de gu wenhua he gu huanjing 葫芦河流域的古文化与古环境 [Ancient cultures and environment of the Huluhe Valley]. KG 9, 1993, 822-842.

Li H. H. 1980

Li Huhou 李虎候, Qijia wenhua tongjing de fei pohuaixing jianding 齐家文化铜镜的非破坏性鉴定 [Non-destroyed identity of bronze mirrors of the Qijia culture]. KG 4, 1980, 365-368.

Li H. R. 2003

Li Hairong 李海荣, Beifang diqu chutu Xia Shang Zhou shiqi qingtongqi yanjiu 北方地区出土夏商周时期青铜器研究 [Research on the Bronze Objects of the Xia, Shang and Zhou Dynasties unearthed from the Chinese Northern Frontier area] (Beijing 2003).

Li J. 1935

Li Ji 李济, Yinxu tongqi wuzhong jiqi xiangguan wenti 殷墟铜器五种及其相关问题 [Five

bronze artifacts of Yinxu and related questions]. In: Qingzhu Caiyuanpei xiansheng liushiwu sui lunwenji 庆祝蔡元培先生六十五岁论文集 (Collected work for celebrating the 65th Birthday of Mr. Cai Yuanpei) (Beijing 1935), 522-546.

Li J. H. 1980

Li Jinghan 李经汉, Shi lun Xiajiadian xia ceng wenhua de fenqi he yanjiu 试论夏家店下层文化的分期和类型 [Tentative discussion on the periodization and classification of the Lower Xiajiadian culture]. Nianhui 1, 1980, 163-170.

Li J. H. 1985

Li Jinghua 李京华, Guanyu zhongyuan diqu zaoqi yetong jishu ji xiangguan wenti d jidian kanfa 关于中原地区早期冶铜技术及相关问题的几点看法 [On the early Chinese smelting techniques used in the Central Plains and related questions]. WW 12, 1978, 75-78.

Li S. C. 1992

Li Shuicheng 李水城, Zhongguo beifang didai de shewenqi yanjiu 中国北方地带的蛇纹器研究 [Study on the pottery with snake pattern in the Chinese northern belt]. WW 1, 1992, 50-57.

Li S. C. 1993

Li Shuicheng 李水城, Siba wenhua yanjiu 四坝文化研究 [Research on the Siba culture]. KWL 3, 1993, 80-101.

Li S. C. 1994

Li Shuicheng 李水城, Shajing wenhua yanjiu 沙井文化研究 [Research on the Shajing culture]. GXYJ 2, 1994, 493-523.

Li S. C. 1997

Li Shuicheng 李水城, Lun Dongjiatai leixing ji xiangguan wenti 论董家台类型及相关问题 [On Dongjiatai type and related problems]. KY 3, 1997, 95-102.

Li S. C. 2005

Li Shuicheng 李水城, Xibei yu zhongyuan zaoqi yetongye de quyu tezheng ji jiaohu zuoyong 西北与中原早期冶铜业的区域特征及交互作用 [Regional characteristics and interaction of early metallurgy in northwestern China and the Central Plains]. KGXB 3, 2005, 239-277.

Li X. D. 1984

Li Xiandeng 李先登, Shilun zhongguo qingtongqi de qi yuan 试论中国青铜器的起源 [On the origin of Chinese bronzes]. SXYK 1, 1984.

Li X. H. et al. 1996

Li Xiu Hui 李秀辉 et al, Zhukaigou yizhi zaoshang tongqi de chengfen ji jinxiang fenxi 朱开沟遗址早商铜器的成分及金相分析 [Analysis of the elements and metallography of the bronzes during the early Shang period in Zhukaigou]. WW 8, 1996, 84-93.

Li X. Q. 1989

Li Xueqin 李学勤, Shangzhou qingtongqi dui xitu de yingxiang 商周青铜器对西土的影响 [The influence of the Shangzhou bronzes on the western world]. In: LXQ 89, 122-132.

Li X. T. 1992

Li Xiating 李夏廷, Hunyuan Yiqi yanjiu 浑源彝器研究 [Study on Yiqi of Hunyuan]. WW 10, 1992, 61-75].

Li Y. C. 1986

Li Youcheng 李有成, Yuanping xian Liuzhuangta Gangliang dongzhou mu 原平县刘庄塔岗梁东周墓 [The Eastern Zhou tombs in Gangliang, Liuzhuangta, Yuanping county]. WW 11, 1986, 21-26.

Li Y. P. 1993

Li Yiping 李伊萍, Banshan Machang wenhua yanjiu 半山马厂文化研究 [Research on the Machang culture of Banshan]. KWL 3, 1993, 32-65.

Li Y. X. et al. 1999

Li Yanxiang 李延祥 et al, Niuheiliang yetong lubi canpian yanjiu 牛河梁冶铜炉壁残片研究 [Remains of the bronze-casting furnace unearthed at Niuheiliang]. WW 12, 1999, 44-51.

Li Y. X. et al. 2003

Li Yanxiang 李延祥 et al, Dadianzi mudi chutu tongqi chubu yanjiu 大甸子墓地出土铜器初步研究 [A Preliminary study on bronzes from Dadianzi tombs]. WW 7, 2003, 78-84.

Li Y. Y. 1959a

Li Yiyou 李逸友, Neimenggu Zhaowudameng chutu de tongqi diaocha 内蒙昭乌达盟出土的铜器调查 [Survey of the bronzes found at Zhaowudameng, Inner Mongolia]. KG 6, 1959, 276-277.

Li Y. Y. 1959b

Li Yiyou 李逸友, Helingeerxian Fanjiayaozi chutu de tongqi 和林格尔县范家窑子出土的铜器 [Bronze objects found at Fanjiayaozi, Helingeer]. WW 6, 1959, cover 3.

Li Y. Y. 1986

Li Yiyou 李逸友, Helingeerxian Fanjiayaozi chutu de tongqi 和林格尔县范家窑子出土的铜器 [Bronze objects found at Fanjiayaozi, Helinger]. in: Ordos 86, 222.

Li Z. X. 1999

Li Zhixin 李智信, Shilun Majiayao zhi kayue wenhua jingji zhuanbian de yuanyin ji yingxiang 试论马家窑至卡约文化经济转变的原因及影响 [Discussion on the reason and influence of the economic shift from the Majiayao culture to the Kayue culture]. In: QHWUSHINIAN 99, 91-97.

Li. H. C. 1992

Li Hancui, Qinghai Huangzhong xian faxian gudai shuangma tongyue 青海湟中县发现古代双马铜钺和铜镜 [Ancient double-horsed bronze tomahawk and mirror discovered in Huangzhong county, Qinghai]. WW 2, 1992, 16.

Li/ Nan 2003

Li Xiaoqing 李小青/Nan Baosheng 南宝生, Gansu Qingshuixian Liuping jinnian faxian de beifangxi qingtongqi ji jinshipin 甘肃清水县刘坪近年发现的北方系青铜器及金饰片 [The Northern Bronzes and gold ornaments found in Liuping, Qingshui county, Gansu Province in recent years]. WW 7, 2003, 4-17.

Li/Fu 1978

Li Yimin 李逸民/Fu Junshan 傅俊山, Liaoning Xingchengxian Yanghe faxian qingtongqi 辽宁兴城县杨河发现青铜器 [Bronzes discovered in Yanghe, Xingcheng, Liaoning]. KG 6,

1978, 387.

Li/Gao 1964

Li Hengnian 李亨年/ Gao Donglu 高东陆, Qinghai Datongxian Dongxia Baoku faxian Kayao wenhua yizhi 青海大通县东峡, 宝库地区发现卡窑文化遗址 [Kayao culture sites discovered at Dongxia, Baoku, Datong county, Qinghai]. KG 9, 1964, 475-476.

Li/Han 1990

Li Yanxiang 李延祥/Han Rubin 韩汝玢, Linxixian Dajing gutong kuangye yizhi yelian jishu yanjiu 林西县大井古铜矿冶遗址冶炼技术研究 [On smelting techniques in one ancient copper-ore site Dajing, Lixin county]. ZKY 2, 1990, 151-160.

Li/Han 1992

Li Xiuhui 李秀辉/Han Rubin 韩汝玢, Qinghai Dulan Tufan muzang chutu jinshu wenwu de yanjiu 青海都兰吐蕃墓葬出土金属文物的研究 自然科学史研究 [A few cultural relics unearthed in Zongansi, Zhamao, Tongren]. QHWW 6, 1992, 10-21.

Li/Han 2002

Li Xiuhui 李秀辉/ Han Rubin 韩汝玢, Zhukaigou yizhi chutu tongqi de Jinxiangxue yanjiu 朱开沟遗址出土铜器的金相学研究 [On the Metallography of the bronzes unearthed from Zhukaigou]. YJL 3, 2002, 242-259.

Li/Lu 1981

Li Guolin 李国林/Lu Yaoguang 卢耀光, Kayue wenhua de zangshi 卡约文化的葬式 [Burial patterns of the Kayue culture]. QHKK 12, 1981, 38-48.

Li/Shui 1988

Li Shuicheng 李水城/Shui Tao 水涛, Jiuquan Ganguya mudi 酒泉干骨崖墓地 [Ganguya cemetery in Jiuquan]. In: Nianjian 88, 271.

Li/Shui 2000

Li Shuicheng 李水城/Shui Tao 水涛, Siba wenhua tongqi yanjiu 四坝文化铜器研究 [On the bronzes of the Siba culture]. WW 3, 2000, 36-44.

Li/Shui 2005

Li Shuicheng 李水城/Shui Tao 水涛, Gongyuanqian yi qianji de Hexi zoulang xibu 公元前 1 千纪的河西走廊西部 [The west of the Gansu corridor in the first Millenium before Christ] .In: Subai xiansheng bazhi huadan jinian wenji 宿白先生八秩华诞纪念文集 (Collection for Commemorating the Eightieth Birthday of Subai) (Beijing 2002), 63-73.

Li/Yin 1995

Li Zongshan 李宗山/Yin Xiaoyan 尹小燕, Hebeisheng Qian'an xian chutu liang jian Shangdai tongqi 河北省迁安县出土两件商代铜器 [Two bronzes of the Shang period from Qian'an county, Hebei Province]. WW 6, 1995, 88-89.

Liang/Yu 2001

Liang Baoling 梁宝玲/Yu Qiong 瑜琼, Lun Zhangjiayuan mudi de niandai he wenhua shuxing 论张家园墓地的年代和文化属性 [On the chronology and cultural ascription of the Zhangjiayuan cemetery]. BFWW 2, 2001, 17-23.

Liang S. Y. 1935

Liang Siyong 梁思永, Xiaotun Longshan yu Yangshao 小屯龙山与仰韶 [Longshan and Yangshao at Xiaotun]. In: Qingzhu Caiyuanpei xiansheng liushiwu sui lunwenji 庆祝蔡元培先生六十五岁论文集 [Collected work for celebrating the 65th Birthday of Mr. Cai Yuanpei] (Beijing 1935), 546.

Liang S. Y. 1933

Liang Siyong 梁思永, Ang'angxi shiqian yizhi 昂昂溪史前遗址 [Prehistoric remains in Ang'angxi]. LYY 4(1), 1933, 1-44.

Liang X. P. 1984

Liang Xingpeng 梁星彭, Qijia wenhua qiyuan tantao 齐家文化起源探讨 [Discussion on the origin of the Qijia culture]. SQYJ 3, 1984, 32-40.

Liang X. P. 1996

Liang Xingpeng 梁星彭, Zhangjiapo xizhou dongshi mu yuzushu tantao 张家坡西周洞室墓与族属探讨 [Discussion on the origin and ethnic people of the shaft pit graves during the Western Zhou in Zhangjiapo]. KG 5, 1996, 68-76.

Liang/Sun 2002

Liang Honggang 梁宏刚/Sun Shuyun 孙淑云, Erlitou caiji qingtong Yue fenxi ceshi baogao 二里头采集青铜钺分析测试报告 [Report on the analysis and test of the bronze Yue collected from Erlitou]. KG 11, 2002, 33-34.

Liang/Sun 2004

Liang Honggang 梁宏刚/Sun Shuyun 孙淑云, Erlitou yizhi chutu tongqi yanjiu zongshu 二里头遗址出土铜器研究综述 [On the bronzes unearthed at the Erlitou site]. ZYWW1, 2004, 29-37.

Lilunyushijian 89

Gao Chongwen 高崇文 / Yu Weichao 俞伟超 (Ed.), Kaogu leixingxue de lilun yu shijian 考古类型学的理论与实践 [Theory and Practice of Archaeological Typology] (Beijing 1989).

Lin M. C. 1998

Lin Meicun 林梅村, Shangzhou qingtong jian yuanyuan kao 商周青铜兼渊源考 [On the origin of the bronze swords of the Shang and Zhou period]. In: Hantang xiyu yu wenming 汉唐西域与中国文明 (Western World of Han and Tang period and Chinese Civilization) (Beijing 1998), 39-63.

Lin Y. 1986

Lin Yun 林沅, A reexamination of the relationship between the bronzes of the Shang culture and the Northern zone (Chinese bookshop 2000). In: Chang 1986, 237-273.

Lin Y. 1998a

Lin Yun 林沅, Zhongguo dongbeixi qingtong duanjian chulun 中国东北系青铜短剑初论 [Preliminary Study of northeastern style bronze dagger in China]. In: LY 98, 311-334.

Lin Y. 1998b

Lin Yun 林沅, Guanyu qingtong gongxingqi de ruogan wenti 关于青铜弓形器的若干问题 [Several issues regarding bow-shaped bronze artifacts]. In: LY 98, 251-261.

Lin Y. 1998c

Lin Yun 林沅, Shang wenhua qingtongqi yu beifang diqu qingtongqi guanxi zhi zai yanjiu 商文化青铜器与北方地区青铜器关系之再研究 [A reconsideration of the relationship between the Shang Dynasty culture and the northern style bronzes]. In: LY 98, 262-281.

Lin Y. 1998d

Lin Yun 林沅, Guanyu Zhongguo de dui Xiongnu zuyuan de kaoguxue yanjiu 关于中国的对匈奴族源的考古学研究 [On study of the origin of the Xiongnu people in Chinese archaeology]. In: LY 98, 368-386.

Lin Y. 1998e

Lin Yun 林沅, Zaoqi beifangxi qingtongqi de jige niandai wenti 早期北方系青铜器的几个年代问题 [On dating early Northern style Bronzes]. In: LY 98, 289-295.

Lin Y. 1998f

Lin Yun 林沅, Zai lun guajiangou 再论挂缰钩 [Reconsideration on halter hook]. In: LY98, 302-310.

Lin Y. 1998g

Lin Yun 林沅, Zhongguo dongbeixi duanjian zai lun 中国东北系短剑再论 [Reconsideration of Northeastern style bronze dagger in China]. In: LY 98, 335-352.

Lin Y. 1998h

Lin Yun 林沅, Donghu yu Shanrong de kaogu tansuo 东胡与山戎的考古探索 [Archaeological study of the Donghu people and Shanrong people]. In: LY 98, 387-396.

Lin Y. 2002

Lin Yun 林沅, Xiandai de zhongguo beifangxi qingtongqi 夏代的中国北方系青铜器 [Bronze vessels of the Xia Dynasty found in north China]. In: BJKG 1, 2002, 1-12.

Lin Y. 2003

Lin Yun 林沅, Zhongguo beifang changcheng didai youmu wenhuadai de xingcheng guocheng 中国北方长城地带游牧文化带的形成过程 [The formation of the nomadic belt in the Great Wall region of Northern China]. YJXB 14, 2003, 95-145.

Linduff 1998

K. M. Linduff, Zhukaigou, Steppe culture and the rise of Chinese civilization. *Antiquity* 69, 1998, 133-145.

Linduff 2004

K. M. Linduff (ed.), *Metallurgy in ancient Eastern Eurasia from the Urals to the Yellow River* (Lewiston. Queenston. Lampeter 2004).

Linduff et al. 2000

K. M. Linduff/ Han Rubin/Sun Shuyu (ed.), *The beginning of metallurgy in China* (Lewiston. Queenston. Lampeter).

Liu B. 1992

Liu Bing 刘冰, Shi lun Xiajiadian shangceng wenhua de qingtong duanjian 试论夏家店上层文化的青铜短剑 [Tentative discussion on the short bronze swords in Upper Xiajiadian culture]. NMGWK 1&2, 1992, 26-33.

Liu B. A. 1985

- Liu Baoai 刘宝爱, Baoji faxian xindian wenhua taoqi 宝鸡发现辛店文化陶器 [Xindian culture potteries found from Baoji]. KG 9, 1985, 850-852.
- Liu B. H. 1982
Liu Xiaohe 刘宝和, Minhexian Guanting Zhongchuan gudai wenhua yizhi diaocha 民和县官亭中川古代文化遗址调查 [Survey of ancient cultural sites in Guanting, Zhongchuan, Minhe county]. QHKH 4, 1982, 18-22.
- Liu B. S. 1995
Liu Baushan 刘宝山, Qinghai shiqian de tongling 青海史前的铜铃 [Bronze bell in Prehistoric Qinghai]. WWJK 2, 1995, 43-47.
- Liu B. S. 1996a
Liu Baushan 刘宝山, Shilun Qinghai diqu de zaoqi tongqi 试论青海地区的早期铜器 [Discussion on the early bronzes in Qinghai]. In: Qinghaishifan daxue xuebao 青海师范大学学报 (Transaction of Qinghai Pedagogic University 2, 1996, 115-118.
- Liu B. S. 1996b
Liu Baushan 刘宝山, Qinghai chutu de jizhong zaoqi tongqi 青海出土的几种早期铜器 [Some early bronzes discovered in Qinghai]. QHWW 10, 1996, 75-77.
- Liu B. S. 1997a
Liu Baushan 刘宝山, Qinghai qingtong shidai de tongguan he tonghuan 青海青铜时代的铜管和铜环 [Bronze tube and loop of the Bronze Age in Qinghai]. WWJK 1, 1997, 81-84.
- Liu B. S. 1997b
Liu Baushan 刘宝山, Qinghai de qingtong fu he qingtong yue 青海的青铜斧和青铜钺 [Bronze axe and tomahawk in Qinghai]. WWJK 3, 1997, 60-63.
- Liu B. S. 1999
Liu Baushan 刘宝山, Qinghai shiqian de tongpaoshi, tongpianishi he lianzhushi 青海史前的铜泡饰, 铜片饰和连珠饰 [Prehistorical bronze bulb, slice and joined-bead ornaments in Qinghai]. QHWW 3, 1999, 67-70.
- Liu G. X. 2000
Liu Guoxiang 刘国祥, Xiajiadian shangceng wenhua qingtongqi yanjiu 夏家店上层文化青铜器研究 [Research on the bronzes of the Upper Xiajiadian culture]. KGXB 4, 2000.
- Liu J. D. 1993
Liu Jundu 刘军杜, Xianzhou wenhua yu Guangshe wenhua de guanxi 先周文化与光社文化的关系 [On relations between the Pre-Zhou culture and Guangshe culture]. WB 2, 1993, 48-59.
- Liu J. X. 1986
Liu Jinxiang 刘晋祥, Dadianzi erqun taoqi fenxi 大甸子墓地二群陶器分析 [Analysis on the second group of the Dadianzi cemetery]. In: XN 86, 101-104.
- Liu J. Z. 1988
Liu Jianzhong 刘建忠, Hebei Huaian Shizikou faxian de Shangdai lushoudao 河北怀安狮子口发现的商代鹿首刀 [Deer headed knife found at Shizikou, Huai'an, Hebei]. KG 10, 1988, 941.

Liu L. 1987

Liu Li 刘莉, Tong fu kao 铜鍳考 [On the bronze Fu vessel]. KYW 3, 1987, 60-65.

Liu L. Q. 2000

Liu Lianqiang 刘连强, Jianguo yilai Ji bei beifang qingtong wenhua faxian yu yanjiu 建国以来冀北北方青铜文化发现与研究 [Discovery and research on the northern bronze cultures found in the north of Hebei since the foundation of the new China]. WWCQ 6, 2000.

Liu P. 1989

Liu Pu 刘溥, Qinghai caitao wenshi 青海彩陶纹饰 [The Designs of the painted pottery in Qinghai] (Xining 1989).

Liu P. 1999

Liu Pu 刘朴, Chengde xian jingnei de Xiajiadian xiaceg wenhua yizhi 承德县境内的夏家店下层文化遗址 [The Lower Xiajiadian culture sites inside the Chengde county]. WWCQ 4, 1999.

Liu Q. 1986

Liu Qian 刘谦, Jinzhou Shanheyingzi yizhi fajue baogao 锦州山河营子遗址发掘报告 [Excavation at the Shanheyingzi site, Jinzhou]. KG 10, 1986, 873-881.

Liu S. Z. 1996

Liu Shizhong 刘诗中, Zhongguo zaoqi tongkuang chubu yanjiu 中国早期铜矿初步研究 [Primary research on the early copper-ore sites in China]. Nianhui 8, 1996, 197-207.

Liu X .G. 2003

Liu Xinggai 刘杏改, Qiantan Qinghai diqu de qingtong wenhua 浅谈青海地区的青铜文化 [Discussion on the bronze cultures in the Qinghai region]. WWCQ 6, 2003, 29-32.

Liu X. G. 1995

Liu Xinggai 刘杏改, Kayue wenhua mudizhong suo fanying de shehui wenti 卡约文化墓地中所反映的社会问题 [The social problems reflected in the burials of the Kayue culture]. QHWW 9, 1995, 61-63.

Liu X. G. 1996

Liu Xinggai 刘杏改, Qiantan Kayue wenhua de renxun he shengxun 浅谈卡约文化的人殉和牲殉 [About the people and animals buried alive with the dead in the Kayue culture]. QHWW 10, 1996, 87-89.

Liu X. H. et al. 1982

Liu Xiaohe 刘小河 et al., Minhe xian Guanting, Zhongchuan gudai wenhua yizhi diaocha 民和县官亭, 中川古代文化遗址调查 [Survey at ancient sites in Guanting and Zhongchuan, Minhe county]. QHKH 4, 1982, 18-22.

Liu X. T. 1993

Liu Xuetao 刘学堂, Xinjiang diqu zaoqi tongqi ji xiangguan wenti 新疆地区早期铜镜及相关问题 新疆文物 [On the early bronze mirrors in Xinjiang and related questions]. XJWW 1, 1993, 121-131.

Liu X. T. 1993

Liu Xuetao 刘学堂, Xinjiang diqu qingtong shidai dao zaoqi tieqi shidai kaogu

wenhua zhong de liangge wenti 新疆地区青铜时代到早期铁器时代考古文化中的两个问题 [Two problems on the archaeological cultures during the Bronze Age to the early Iron Age in Xinjiang]. In: QGJ 93,309-317.

Liu X. T. 1998

Liu Xuetao 刘学堂, Zhongguo zaoqi tongjing qiyuan yanjiu 中国早期铜镜起源研究 [On the origin of the early Chinese bronze mirrors]. XJWW 3, 1998, 55-72.

Liu Y. M. 1993

Liu Yiman 刘一曼, Yinxu Qingtong dao 殷墟青铜刀 [Bronze knives of the Yinxu]. KG 2, 1993, 150-166.

Liu Z. 1995

Liu Zhen 刘震, Hebei Zunhua xian faxian yizuo shangdai mu 河北遵化县发现一座商代墓 [One tomb of the Shang period from Zunhua county, Hebei]. KG 5, 1995, 470.

Liu/Chen 1990

Liu Xiaoqiang 刘小强/ Chen Rong 陈荣, Datong xian chutu de san jian qingtongqi 大通县出土的三件青铜器 [Three pieces of bronze discovered in Datong county]. QHWW 5, 1990, 83.

Liu/Dou 1998

Liu Baoshan 刘宝山/Dou Xuyao 窦旭耀, Qinghai Hualong xian Xiabanzhuwa Kayue wenhua mudi di er ci fajue jianbao 青海化隆县下半主洼卡约文化墓地第二次发掘简报 [Brief report on the second excavation at the Xiabanzhuwa graveyard of the Kayue culture in Hualong county, Qinghai]. KYW 4, 1998, 3-11.

Liu/Li 2002

Liu Lianqiang 刘连强/Li Jun 李珺, Pingquan xian Banjiegou Xiajiadian xiaceng wenhua yizhi 平泉县半截沟夏家店下层文化遗址 [The Lower Xiajiadian culture site at Banjiegou, Pingquan county]. ZKN 2000.

Liu/Xu 1981

Liu Guangmin 刘观民/Xu Guangji 徐光冀, Neimenggu dongbu diqu qingtong shidai de liangzhong wenhua 内蒙古东部地区青铜时代的两种文化 [Two bronze cultures in east Inner Mongolia]. NMGWK 1, 1981, 5-14.

Liu/Xu 1988

Liu Dezhen 刘得祯/Xu Shuzhen 许淑珍, Gansu Qingyang chunqiu zhanguo muzang de qingli 甘肃庆阳地区春秋战国墓葬的清理 [The Excavation of the Spring and Autumn and Warring States period burials in the Qingyang region, Gansu]. KG 5, 1988, 413-424.

Liu/Zhao 2001

Liu Xu 刘绪/Zhao Fusheng 赵福生, Weifang san qi wenhua de niandai yu Liujiache M1de shuxing 围坊三期文化的年代与刘家河 M1 的属性 [The age of the Weifang phase III and the nature of Liujiache M1]. In: SK, 146-152.

Liu/Zhu 1981

Liu Dezhen 刘得祯/Zhu Jiantang 朱建唐, Gansu Lingta xian Jingjiazhuang chunqiu mu 甘肃灵台县景家庄春秋墓 [The Spring and Autumn burials found at Jingjiazhuang, Lingtai, Gansu]. KG 4, 1981, 298-301.

Liulihe 1995

Beijingshi wenwu yanjiusuo 北京市文物研究所, Liulihe Xizhou Yanguo mudi 琉璃河西周燕国墓地 [Yan State Cemetery at Liulihe in the Western Zhou Period] (Beijing 1995).

Liuwan 84

Qinghaisheng wenwu guanlichu kaogudui 青海省文物管理处考古队 et al., Qinghai Liuwan 青海柳湾 [Liuwan in Qinghai] (Beijing 1984).

LNB 1985

Liaoningsheng bowuguan 辽宁省博物馆, Liaoning Lingyuanxian Sanguandian qingtong duanjian mu 辽宁凌源县三官甸青铜短剑墓 [Burials with bronze short-swords at Sanguandian, Lingyuan county, Liaoning]. KG 2, 1985, 129.

LNBG 1983

Liaoningsheng bowuguan gongzuodui 辽宁省博物馆工作队, Liaoning Linxixian Dajing gutongkuang 1976 nian shijue jianbao 辽宁林西县大井古铜矿 1976 年发掘简报 [The tentative excavation of the ancient copper ore site at Dajing, Linxi county, Liaoning in 1976]. WWZC 7, 1983, 138-144.

LNWY 1989

Liaoning sheng wenwu kaogu yanjiusuo 辽宁省文物考古研究所, Liaoning Lingyuan xian wudahezi zhanguo mu fajue jianbao 辽宁凌源县五道河子战国墓发掘简报 [Excavation of the Warring States burials at Wudahezi, Lingyuan, Liaoning]. WW 2, 1989, 52-61.

LNZ et al. 1973

Liaoningsheng Zhaowudameng wenwu gongzuozhan, Ningchengxian Nanshangen de shiguomu 宁城南山根的石椁墓 [Sarcophagus at Nanshangen, Ningcheng]. KGXB 2, 1973, 27-38.

Loehr 1949

M. Loehr, Weapons and tools from Anyang and Siberian Analogies. *American Journal of Archaeology* 53, 1949, 126-144.

Loehr 1951

M. Loehr, Ordos daggers and knives: New Material, Classification and Chronology. Second part: Knives, *Artibus Asiae* Vol.14, 1951, 77-162.

LPB 1995

Luanping xian bowuguan 滦平县博物馆, Hebeisheng Luanping xian Lishugoumen Shanrong mudi qingli jianbao 河北省滦平县梨树沟门山戎墓地清理简报 [Excavation of the Shanrong cemetery at Lishugoumen, Luanping county, Hebei Province]. KYW 5, 1995, 8-15.

Lü Z. E. 1958

Lü Zun'e 吕遵鄂, Neimenggu Chifeng Hongshan kaogu diaocha baogao 内蒙古赤峰红山考古调查报告 [Survey report of Hongshan, Chifeng, Inner Mongolia]. KGXB 3, 1958, 25-40.

Lü Z. R. 1987

Lü Zhirong 吕智荣, Shi lun Shanjin beibu huanghe liang an diqu chutu de Shang dai qingtongqi ji youguan wenti 试论陕晋北部黄河两岸地区出土的商代青铜器及有关问题 [On the Shang bronzes discovered from the banks of the Yellow River in the north of the Shanjin region]. In: XN 87, 214-225.

Lü Z. R. 1989

Lü Zhirong 吕智荣, Shi Lun Lijiaya wenhua de jige wenti 试论李家崖文化的几个问题 [Tentative discussion on some problems regarding the Lijiaya culture]. KYW 4, 1989, 75-79.

Lü Z. R. 1991

Lü Zhirong 吕智荣, Zhukaigou wenhua yicun yu Lijiaya wenhua 朱开沟文化遗存与李家崖文化 [The Zhukaigou culture and Lijiaya culture]. KYW 6, 1991, 47-52.

Lu/Ge1978

Lu Qi 鲁琪/Ge Yinghui 葛英会, Beijing shi chutu wenwu zhanlan xunli 北京市出土文物展览巡礼 [Exhibition of the cultural relics found from Beijing]. WW 4, 1978, 23-34.

Luo F. 1983

Luo Feng 罗丰, Ningxia Guyuan Shilacun faxian yizuo zhanguomu 宁夏固原石喇村发现一座战国墓 [One Warring States tomb excavated at Shila, Guyuan, Ningxia]. KGXJ 3, 1983, 131-132, 142.

Luo F. 1990

Luo Feng 罗丰, Guyuan qingtong wenhua chulun 固原青铜文化初论 [Primary discussion on bronze culture in Guyuan]. KG 8, 1990, 743-750.

Luo F. 1993

Luo Feng 罗丰, Yi longshan wei zongxin Ganning diqu chunqiu zhanguo shiqi beifang qingtong wenhua yanjiu 以陇山为中心甘宁地区春秋战国时期北方青铜文化的发现与研究 [Research on the northern bronze culture of the Spring and Autumn and Warring States periods in the Gansu and Ningxia regions centered by Longshan]. NMGWK 1&2, 1993, 29-49.

Luo F. 2002

Luo Feng 罗丰, Ershi shiji Ningxia kaogu de huigu yu sikao 20世纪宁夏考古的回顾与思考 [Review and thinking of the Ningxia archaeology in the 20th century]. KG 8, 2002, 3-12.

Luo/ Yan 1993

Luo Feng 罗丰/Yan Shizhong 延世忠, 1988 nian Guyuan chutu de beifangxi qingtongqi 1988年固原出土的北方系青铜器 [Northern bronzes unearthed from Guyuan in 1988]. KYW 4, 1993, 17-21.

Luo/Han 1990

Luo Feng 罗丰/Han Kongle 韩孔乐, Ningxia Guyuan jinnian faxian de beifangxi qingtongqi 宁夏固原近年发现的北方系青铜器 [Northern bronzes discovered from Guyuan, Ningxia in recent years]. KG 5, 1990, 403-418.

LXQ 89

Li Xueqin 李学勤, Lixueqin ji 李学勤集 [Collected Work of Li Xueqin] (Heilongjiang 1989).

LY 98

Lin Yun 林沅, Linyun xueshu wenji 林沅学术文集 [Collected work of Linyun] (Beijing 1998).

LYG 1985

Luoyang wenwu gongguodui 洛阳文物工作队, Luoyang xijiao sihaomu fajue diannao 洛阳西郊四号墓发掘简报 [Excavation of the 4th Tomb in the western outskirts of Luoyang].

WWZC 9, 1985, 141-150.

Ma J. J. 2006

Ma Jianjun 马建军, *Ningxia jingnei Beifangxi qingtongqi jiqi wenhua tezheng* 宁夏境内“北方系青铜器”及其文化特征 [On the Northern bronzes in the Ningxia Province and related cultural characteristics]. *Ningxia shehui kexue* 宁夏社会科学 Ningxia Society and Science, 2006, 125-129.

Ma L. 1999

Ma Lan 马兰, *Qinghai wenwu jingpin tuji* 青海文物精品图集 [Collected pictures of refined cultural relics in Qinghai] (Beijing 1999).

Ma. H. L. 1983

Ma Honglu 马洪路, *Hebei Yutian xian faxian xinshiqi he qingtong shidai yizhi* 河北玉田县发现新石器 and 青铜时代遗址 [The Neolithic and Bronze Age sites found from Yutian county, Hebei]. *KG* 5, 1983, 478.

Maddin 1988

R. Maddin, *The Beginning of the Use of Metals and Alloys* (London 1988).

Maechen. Helfen 1973

O. J. Maechen. Helfen, *The World of the Huns*, Berkeley, (University of California 1973).

Mair 1990

V. H. Mair, *Old Sinitic Myag, Old Persian Magus and English “Magician”*. *Early China* 15, 1990, 27-47.

Masson 1992

V. M. Masson, *The decline of the Bronze Age civilization and movements of the tribes*. In: *Dani/Masson* 1992, 337-356.

Mei J. J. 2004

Mei Jian Jun 梅建军, *Metallurgy in Bronze Age Xinjiang and its cultural context*. In: *Linduff* 2004, 173-188.

Mei J. J. 2006

Mei Jianjun 梅建军, *Guanyu zhongguo yejin qi yuan ji zaoqi tongqi yanjiu de jige wenti* 关于中国冶金起源及早期铜器研究的几个问题 [On the origin of Chinese Metallurgy and early bronzes]. *YJL* 4, 2006, 11-23.

Mei/Li 2002

Mei Jianjun 梅建军 / Li Yanxiang 李延祥, *Xinjiang Nulasai gutong kuangye yizhi yelian jishu chubu yanjiu* 新疆怒拉赛古铜矿冶遗址冶炼技术初步研究 [Primary research on the smelting technology in Nulasai, one ancient ore site in Xinjiang]. *YJL* 3A, 2002, 48-54.

Meng/Zhao 1994

Meng Zhaoyong 孟昭勇/Zhao Ligu 赵立国, *Hebei Luan xian chutu wan Shang qingtongqi* 河北滦县出土晚商青铜器 [The late Shang bronzes from Luan county, Hebei]. *KG* 4, 1994, 376.

Migration und Kulturtransfer 2001

Eurasien-Abteilung Orient-Abteilung des Deutschen Archäologischen Instituts (Ed.),

Migration und Kulturtransfer-Der Wandel vorder-und zentralasiatischer Kulturen im Umbruch vom 2. zum 1. vorschristlichen Jahrtausend Akten des Internationalen Kolloquiums Berlin, 23. bis 26. November 1996 (Dr. Rudolf Habelt GmbH. Bonn 2001).

Miyake Toshihiko 2005

Miyake Toshihiko 三宅俊彦, Kayue wenhua qingtongqi chubu yanjiu 卡约文化青铜器初步研究 [Primary research on the cultures of the Kayue culture]. KG 3, 2005, 73-88.

Miyamoto Kazuo 2001

Miyamoto Kazuo 宫本一夫, Erduosi qingtong wenhua de diyuxing ji bianqian 鄂尔多斯青铜文化的地域性及变迁 [The region and changes of the Ordos bronze culture]. In: Daihai II, 2001, 454-481.

MJJ 2000

Mei Jianjun 梅建军, Copper and Bronze Metallurgy in Late Prehistoric Xinjiang: Its Cultural Context and Relationship with Neighboring Regions (Oxford 2000).

Mu/Qi 1998

Mu Shunying 穆舜英 / Qi Xiaoshan 祁小山, Xinjiang Caitao 新疆彩陶 [Painted pottery in Xinjiang] (Beijing 1998).

Muhly 1988

J. D. Muhly, The beginning of metallurgy in the old world. In: Maddin 1988, 2-20.

Nan Y. Q. 1989

Nan Yuquan 南玉泉, Xindian wenhua xulie jiqi yu Kayue Siwa wenhua de guanxi 辛店文化序列及其与卡约寺洼文化的关系 [The Xindian cultural series and its relationship with the Kayue and Siwa cultures]. In: Lilunyushijian 89, 73-109.

Nan Y. Q. et al. 1987

Nan Yuquan 南玉泉 et al, Siwa-Anguo xitong taoli de xulie 寺洼-安国系统陶鬲的序列 [The sequence of pot Li(tripod) in the Siwa-Anguo system]. WW 2, 1987, 27-34.

Nianjian 88

Zhongguo kaoguxuehui 中国考古学会, Zhongguo kaoguxue nianqian 1987 中国考古学年鉴 1987 [Chinese Archaeology Almanac 1987] (Beijing 1988).

Nianjian 93

Zhongguo kaoguxuehui 中国考古学会, Zhongguo kaoguxue nianqian 1993 中国考古学年鉴 1993 [Chinese Archaeology Almanac 1993] (Beijing 1995).

Ning D. X. 1960

Ning Duxue 宁笃学, Minlexian faxian de liangchu Siba wenhua yizhi 民乐县发现的二处四坝文化遗址 [Two Siba culture sites discovered from Minle county]. WW 1, 1960, 74-75.

NMGB et al. 1986

内蒙古博物馆 et al., Yulongtai zhanguomu 玉隆太战国墓 [The Warring states tombs at Yulongtai]. In: Ordos 86, 367-371.

NMGB et al. 1977

Neimenggu bowuguan 内蒙古博物馆 et al, Neimenggu Zhungeerqi Yulongtai de Xiongnu 内蒙古准格尔旗玉隆太的匈奴墓 [The Xiongnu tombs at Yulongtai, Zhungeerqi, Inner

Mongolia]. KG 2, 1977, 111-114.

NMGDBQ

Neimenggu wenwu kaogu yanjiusuo 内蒙古文物考古研究所 ed., Neimenggu dongbuqu kaoguxue wenhua yanjiu wenji 内蒙古东部区考古学文化研究文集 [Papers on the archaeological cultures in east Inner Mongolia] (Beijing 1991).

NMGG 1961

Neimengguzizhiqu wenwu gongzuodui 内蒙古自治区文物工作队, Neimengguzizhiqu Zhaolainuoer gumuqun fajue jianbao 内蒙古扎赉诺尔古墓群发掘简报 [Brief report on the excavation of the tombs at Zhaolainuoer, Inner Mongolia]. KG 12, 673-680.

NMGG 1965a

Neimengguzizhiqu wenwu gongzuodui 内蒙古自治区文物工作队, Neimengguzizhiqu Ningchengxian Xiaoyushulinzi yizhi shijue baogao 内蒙古宁城县小榆树林子遗址试掘报告 [Experimental excavation at the Xiaoyushulin site, Ningcheng county, Inner Mongolia]. KG 12, 1965, 619-621.

NMGG 1965b

Neimengguzizhiqu wenwu gongzuodui 内蒙古自治区文物工作队, Neimengguzizhiqu Chenbaerhuqi wangong gumu qingli jianbao 内蒙古陈巴尔虎旗完工古墓清理简报 [The brief report on the excavation of the ancient tombs at Chenbaerhuqi, Inner Mongolia]. KG 6, 1965, 273-283.

NMGG 1984

Neimengguzizhiqu wenwu gongzuodui 内蒙古自治区文物工作队, Liangchengxian Yinniugou muzang qingli jianbao 凉城县饮牛沟墓葬清理简报 [Brief report on the excavation at Yinniugou, Liangcheng county]. NMGWK 3, 1984, 26-32.

NMGG 1986

Neimengguzizhiqu wenwu gongzuodui 内蒙古自治区文物工作队, Maoqinggou mudi 毛庆沟墓地 [Maoqinggou cemetery]. In: Ordos 86 (Beijing), 227-315.

NMGG et al. 1979

Neimengguzizhiqu wenwu gongzuodui 内蒙古自治区文物工作队 et al, Neimengguzizhiqu wenwu kaogu gongzuo sanshinian 内蒙古文物考古工作三十年 [30 years of cultural relics and archaeological work at Inner Mongolia]. In: Sanshinian 79, 69-83.

NMGL 1966

Neimenggu lishi yanjiusuo 内蒙古历史研究所, Neimenggu Qingshuihexian Bainiyaoyi ziyhi fucha 内蒙古清水河县白泥窑子遗址复查 [The re-survey of the Bainiyaozi site in the Qingshuihe site, Inner Mongolia]. KG 3, 1966, 115-121.

NMGWZX 1964

Neimenggu wenwu gongzuodui 内蒙古文物工作队, Neimenggu wenwu ziliao xuanji 内蒙古文物资料选辑 [Collection of materials of cultural relics in Inner Mongolia] (Huhehaote 1964).

NMGXJ 63

Neimengguzizhiqu wenwu gongzuodui 内蒙古自治区文物工作队, Neimengguzizhiqu chutu wenwu xuanji 内蒙古出土文物选集 [Collection of the Cultural Relics unearthed from Inner

Mongolia] (Beijing 1963).

NMGY 1988

Neimengguzizhiqiu wenwu kaogu yanjiusuo 内蒙古自治区文物考古研究所, Neimengguzizhiqiu Zhukaigou yizhi 内蒙古朱开沟遗址 [Zhukaigou site in Inner-Mongolia]. KGXB 3, 1988, 301-331.

NMGY 1989

Neimengguzizhiqiu wenwu kaogu yanjiusuo 内蒙古自治区文物考古研究所, Liangcheng Guoxianyaozi mudi 凉城崞县窑子墓地 [Guoxianyaozi cemetery at Liangcheng]. KGXB 1, 1989, 57-81.

NMGY 1991

Neimengguzizhiqiu wenwu kaogu yanjiusuo 内蒙古自治区文物考古研究所, Baotou Xiyuan chunqiu mudi 包头西园春秋墓地 [Spring and Autumn period cemetery at Xiyuan, Baotou]. NMGWK 1, 1991, 13-23.

NMGY 1994

Neimenggu wenwu kaogu yanjiusuo 内蒙古文物考古研究所, Neimenggu Zhungeerqi Nanhao yizhi 内蒙古准格尔旗南壕遗址 [The Nanhao site at Zhungerqi, Inner Mongolia]. NMGWKW 1, 1994, 205-224.

NMGY 1997a

Neimengguzizhiqiu wenwu kaogu yanjiusuo 内蒙古自治区文物考古研究所, Neimenggu Zhungeerqi Erliban yizhi di er ci fajue baogao 内蒙古准格尔旗二里半遗址第二次发掘简报 [The second excavation at the Erliban site, in Zhungerqi, Inner Mongolia]. KGXJ 1997, 84-129.

NMGY 1997b

Neimenggu wenwu kaogu yanjiusuo 内蒙古文物考古研究所, Zhungeerqi Zhaizita yizhi 内蒙古准格尔旗寨子塔遗址 [The Zhaizita site at Zhungerqi, Inner Mongolia]. NMGWKW 2, 1997, 280-326.

NMGY 1997c

Neimenggu wenwu kaogu yanjiusuo 内蒙古文物考古研究所, Zhungeerqi Guandi yizhi 内蒙古准格尔旗官地遗址 [The Guandi site at Zhungerqi]. NMGWKW 2, 1997, 85-119.

NMGY et al. 1991

Neimengguzizhiqiu wenwu kaogu yanjiuguo 内蒙古自治区文物考古研究所 et al., Neimenggu Keshenketengqi Longtoushan yizhi di yi er ci fajue jianbao 内蒙古克什克腾旗龙头山遗址第一二次发掘简报 [The first and second excavation at Longtoushan, Keshenketengqi, Inner Mongolia]. KG 8, 1991, 704-712.

NMGY et al. 1997

Neimenggu wenwu kaogu yanjiusuo 内蒙古文物考古研究所, Yijinhuoluoqi Baiaobao mudi fajue jianbao 伊金霍洛旗白敖包墓地发掘简报 [Brief report on the excavation at the Baiaobao cemetery in Yijinhuoluoqi]. NMGWKW2, 1997, 327-337.

NMGY et al. 2001

Neimengguzizhiqiu wenwu kaogu yanjiusuo 内蒙古自治区文物考古研究所 et al, Yinniugou mudi 1997 nian fajue baogao 饮牛沟墓地 1997 年发掘报告 [Excavation at the Yinniugou

cemetery in 1999].In: Daihai II 2001, 278-327.

NMGY/QSHW 2001

Neimenggu wenwu kaogu yanjiusuo 内蒙古文物考古研究所/QingshuiHE xian wenwu guanlisuo 清水河县文物管理所, Qingshuihe xian Xicha yizhi fajue jianbao 清水河县西岔遗址发掘简报 [Brief report on the excavation at Xicha, Qingshuihe county]. In: Wanjiashai (Huhehaote 2001), 60-80.

NMGZN 91

Neimenggu wenwu kaogu yanjiusuo 内蒙古文物考古研究所 (ed.), Neimenggu zhongnanbu yuanshi wenhua yanjiu wenji 内蒙古中南部原始文化研究文集 [Academic work on the research of primitive culture in the middle south of Inner Mongolia] (Beijing 1991).

NXB et al. 1987

Ningxia huizu zizhiqu bowuguan 宁夏回族自治区博物馆 et al, Ningxia Tongxinian Daodunzi handai xiongnu mudi fajue jianbao 宁夏同心县倒墩子汉代匈奴墓地发掘简报 [Brief report on the excavation of the Xiongnu burials of the Han Dynasty in Tongxin county, Ningxia]. KG 1, 1987, 33-37.

NXY 1989

Ningxia wenwu kaogu yanjiusuo 宁夏文物考古研究所, Ningxia Haiyuanxian Caiyuancun yizhi Daoqieba mu 宁夏海原县菜园村遗址刀切巴墓地 [Daoqieba cemetery at Caiyuan village, Haiyuan county, Ningxia]. KGXB 4, 1989, 415-444.

NXY 1991

Ningxia wenwu kaogu yanjiusuo 宁夏文物考古研究所, Ningxia Guyuan Yujiazhuang mudi fajue jianbao 宁夏固原于家庄墓地发掘简报 [Brief report on the excavation at the Yujiazhang cemetery, Guyuan, Ningxia]. HXKG 3, 1991, 55-63.

NXY 1995

Ningxia wenwu kaogu yanjiusuo 宁夏文物考古研究所, Ningxia Pengbao Yujiazhuang mudi 宁夏彭堡于家庄墓地 [Yujiazhuang cemetery at Pengbao, Ningxia]. KGXB 1, 1995, 79-106.

NXY et al. 1988

Ningxia wenwu kaogu yanjiusuo 宁夏文物考古研究所 et al, Ningxia Tongxin Daodunzi Xiongnu mudi 宁夏同心县倒墩子匈奴墓地 [Xiongnu cemetery at Daodunzi, Tongxin county, Ningxia]. KGXB 3, 1988, 333-357.

NXY et al. 1993

Ningxia wenwu kaogu yanjiusuo 宁夏文物考古研究所 et al, Ningxia Guyuan Yanglang qingtong wenhua mudi 宁夏固原杨郎青铜文化墓地 [Bronze culture cemetery at Yanglang, Guyuan, Ningxia]. KGXB 1, 1993, 13-56.

NXY et al. 2002

Ningxia wenwu kaogu yanjiusuo 宁夏文物考古研究所 et al, Ningxia Pengyangxian Zhangjiecun Chunqiu zhanguo mudi 宁夏彭阳县张街村春秋战国墓地 [Zhangjie cemetery of the Spring-Autumn and the Warring States in Pengyang county, Ningxia]. KG 8, 2002, 14-24.

NXY/ZLB 1988

Ningxia wenwu kaogu yanjiusuo 宁夏文物考古研究所/Zhongguo lishi boguguan kaogubu

中国历史博物馆考古部, Ningxia Haiyuanxian Caiyuanun yizh, mudi fajue jianbao 宁夏海原县菜园村遗址墓地发掘简报 [Excavation at the Caiyuan site and tombs in Haiyuan, Ningxia]. WW 9, 1988, 1-14.

NXZ 1973

Ningxia huizu zizhi qu zhanlanguan 宁夏回族自治区展览馆, Ningxia Guyuan Haijiawan Qijia wenhua muzang 宁夏固原海家湾齐家文化墓葬 [One Qijia culture cemetery at Haijiawan, Guyuan, Ningxia]. KG 5, 1973, 290-291.

Ordos 86

Tian Guangjin 田广金 / Guo Suxin 郭素新 (Ed.), Eerduosi shi qingtongqi 鄂尔多斯式青铜器 [Ordos Type Bronzes] (Beijing 1986).

Pak Y. J. 1996

Pak Yangjin, A study of the Bronze Age culture in the Northern Zone of China (Ann Arbor 1996).

Pan Q. F. 1986

Pan Qifeng 潘其风, Maoqinggou muzang rengu de yanjiu 毛庆沟墓葬人骨的研究 [Study on human bones in the Maoqinggou graves, Liangcheng, Inner Mongolia]. In: Ordos 86, 316-341.

Pan/Han 1984

Pan Qifeng 潘其风/Han Kangxin 韩康信, Neimenggu Taohongbala gumu he qinghai datong xiongnu mu rengu de yanjiu 内蒙古桃红巴拉古墓和青海大通匈奴墓人骨的研究 [Study on human bones in the Taohongbala burials, Inner Mongolia and Xiongnu tombs in Datong, Qinghai]. KG 4, 1984, 367-375.

Parzinger 2006

Hermann Parzinger 2006, Die Frühen Völker Eurasiens (München 2006).

Pei W. Z. 1987a

Pei Wenzhong 裴文中, Zhongguo xibei gansu zoulang he qinghai diqu de kaogu diaocha 中国西北甘肃走廊和青海地区的考古调查 [Archaeological survey of the Gansu corridor in west northern China and the Qinghai region]. In: PWZLWJ 87, 256-273.

Pei W. Z. 1987b

Pei Wenzhong 裴文中, Gansu shiqian kaogu baogao 甘肃史前考古报告 [Report on prehistorical Gansu]. In: PWZLWJ 87, 208-254.

PLB 1982

Pingliang diqu bowuguan 平凉地区博物馆 (ed.), Pingliang wenwu 平凉文物 [Pingliang cultural relics] (In-house literature).

PWZ 48

Pei Wenzhong 裴文中, Zhongguo shiqian zhi yanjiu 中国史前时期之研究 [Research on the prehistory of China] (Beijing 1948).

PWZLWJ 87

An Zhimin 安志敏 (Ed.), Peiwenzhong shiqian kaoguxue lunwenji 裴文中史前考古学论文集 [Pei Wenzhong's Papers on Prehistorical Archaeology] (Beijing 1987).

QGJ 93

Jilin daxue kaoguxuexi 吉林大学考古学系 (ed.), Qingguoji. Jilin daxue kaogu zhuan yechengli ershi zhounian kaogu lunwenji 青果集. 吉林大学考古专业成立二十周年考古论文集 [Collection of Green Fruits-Collected Works for the twentieth Anniversary of the Archaeology Specialty of Jinlin University (1972-1992)] (Beijing 1993).

QGJ 98

Jilin daxue kaoguxuexi 吉林大学考古学系 (ed.), Qingguoji. Jilin daxue kaoguxi jianxi shi zhounian jinian wenji 青果集. 吉林大学考古系建系十周年考古论文集 [Collection of Green Fruits. Collected Works for the tenth Anniversary of the Archaeology Department of Jilin University] (Beijing 1998).

QHYYB et al. 1985

Qinghaisheng Huangyuanxian bowuguan 青海省湟源县博物馆 et al, 青海湟源县大华中庄卡约文化墓地发掘简报 [Brief report on the excavation of the Kayue culture cemetery at Dahuazhongzhuang in Huangyuan county, Qinghai]. KYW 5, 1985, 11-34.

QHK 1994

Qinghaisheng kaogu yanjiusuo 青海省考古研究所, Qinghai Xunhua Suhusa mudi 青海循化苏乎撒墓地 [Suhusa cemetery in Xunhua, Qinghai]. KGXB 4, 1994, 425-469.

QHK 1989

Qinghaisheng kaogudui 青海省考古队, Qinghai Minhe Hetouzhuang Majiayao leixing yihao muzang 青海民和核桃庄家窑类型一号墓葬 [Majiayao type No.1 tomb at Hetouzhuang, Minhe, Qinghai]. WW 9, 1979, 29-32.

QHKD 1960a

Qinghaisheng wenwu guanlichu 青海省文物管理处, Qinghai Huangzhong gu wenhua diaocha jianbao 青海湟中古文化调查简报 [Survey of the ancient cultures in Huangzhong, Qinghai]. WW 6, 1960, 35-36.

QHW 1960b

Qinghaisheng wenwu guanlichu 青海省文物管理处, Qinghai Chaidamu Pendi Nuomuhong Balong, Xiangride sanchu gu wenhua yizhi diaocha jianbao 青海柴达木盆地诺木洪, 巴隆, 香日德三处古文化遗址调查简报 [Survey of three ancient culture sites at Nuomuhong, Balong and Xiangride in the Chaidamu Basin, Qinghai]. WW 6, 1960, 37-40.

QHW 1976a

Qinghaisheng wenwu guanlichu 青海省文物管理处, Qinghai Ledu Liuwan yuanshi shehui muzang diyici fajue de chubu shouhuo 青海乐都柳湾原始社会墓葬第一次发掘的初步收获 [The preliminary achievement of the first excavation of one primitive cemetery at Liuwan, Ledu, Qinghai Province]. WW 1, 1976, 67-78.

QHW 1976b

Qinghaisheng wenwu guanlichu 青海省文物管理处, Qinghai Ledu Liuyuan yuanshi shehui mudi fanying chu de zhuyao wenti 青海乐都柳湾原始社会墓地反映出的主要问题 [The problems reflected from the cemetery of the primitive society at Liuwan, Ledu, Qinghai]. KG 6, 1976, 365-377.

QHW 1991

Qinghaisheng wenwu guanlichu 青海省文物管理处, Minhe Mapai Machang leixing muzang fajue de zhuyao shouhuo 民和马牌马厂类型墓葬发掘的主要收获 [The main achievement

of excavation at Machang type tombs at Mapai, Minhe]. QHWW 6, 1991, 10-21.

QHW 1992

Qinghaisheng wenwu guanlichu 青海省文物管理处, Qinghai Minhe Hetaozhuang Shanjiatou mudi qingli jianbao 青海民和核桃庄山家头墓地清理简报 [Excavation at Shanjiatou cemetery, Hetaochuang, Minhe, Qinghai]. QHWW 5, 1992, 10-15.

QHW 1995

Qinghaisheng wenwu guanlichu 青海省文物管理处, Qinghai Minhe Hetaozhuang xiaohandi fajue jianbao 青海民和核桃庄小旱地发掘简报 [Brief report of excavation at Xiaohandi, Hetaozhuang, Minhe, Qinghai]. KYW 2, 1995, 1-12.

QHW et al. 1963

Qinghaisheng wenwu guanli weiyuanhui 青海省文物管理委员会 et al, Qinghai Dulan xian Nuomuhong Dalitaliha yizhi diaocha yu fajue 青海都兰县诺木洪搭里他里哈遗址调查与发掘 [Survey and excavation at Dalitaliha, Nuomuhong, Dulan county, Qinghai]. KGXB 1, 1963, 17-43.

QHW et al. 1998

Qinghaisheng wenwu guanlichu 青海省文物管理处 et al, Qinghai tongde xian zongri yizhi fajue jianbao 青海同德县宗日遗址发掘简报 [Brief report on excavation at Zongri, Tongde county, Qinghai]. KG 5, 1998, 1-14.35.

QHWD 1986a

Qinghaisheng wenwu kaogudui 青海省文物考古队, Huan Qinghaihu kaogu diaocha 环青海湖考古调查 [Survey around Qinghai Lake]. KG 3, 1984, 375-383.

QHWD 1986b

Qinghaisheng wenwu kaogudui 青海省文物考古队, Qinghai Huangyuanxian jingnei de Kayue wenhua yiji 青海湟源县境内的卡约文化遗迹 [Remains of Kayue culture inside of Huangyuan county in Qinghai]. KG 10, 1986, 882-886.

QHWD 1986c

Qinghaisheng wenwu kaogudui 青海省文物考古队, Qinghai Huzhu Tuzhu zizhixian Zongzhai Machang, Qijia, Xindian wenhua muzang 青海互助土族自治县总寨马厂, 齐家, 辛店文化墓葬 [Machang, Qijia and Xindian culture tombs in Mazhai, Tuzhu municipalized county, Huzhu, Qinghai]. KG 4, 1986, 306-317.

QHWD et al. 1987

Qinghaisheng kaogudui 青海省文物考古队 et al, Qinghai Guide Shanpingtai Kayue wenhua mudi 青海贵德山坪台卡约文化墓地 [Kayue culture cemetery at Shanpingtai in Guide, Qinghai]. KGXB 2, 1987, 255-273.

QHWK 1979

Qinghaisheng wenguanchu kaogudui 青海省文管处考古队, Qinghaisheng wenwu kaogu gongzuo sanshinian 青海省文物考古工作三十年 [30 years of cultural relics and archaeology work in Qinghai Province]. In: Sanshinian 79, 160-167.

QHWUSHINIAN 99

Qinghai weneu kaogu yanjiusuo 青海文物考古研究所 (Ed.), Qinghai wenwu kaogu wushinian wenji 青海文物考古五十年文集 [Collection of fifty Years of Qinghai Cultural

Relics and Archaeology] (Xining 1999).

QHWWZ 2001

Qinghaisheng difangzhi bianzuan weiyuanhui 青海省地方志编纂委员会, Qinghaisheng zhi.wenwu zhi 青海省志.文物志 [Qinghai province Literature. Archaeological literature] (Xining 2001).

QHY 1990a

Qinghaisheng wenwu kaogu yanjiusuo 青海省文物考古研究所, Tongren xian kaogu diaocha jianbao 同仁县考古调查简报 [Report of archaeological survey at Tongren county]. QHWW 4, 1990, 36-55.

QHY 1990b

Qinghaisheng wenwu kaogu yanjiusuo 青海省文物考古研究所, Qinghai Pingan Huzhu xian kaogu diaocha jianbao 青海平安, 互助县考古调查简报 [Brief report of survey in Ping'an and Huzhu county, Qinghai]. KG 9, 1996, 774-783.

QHY 1990c

Qinghaisheng wenwu kaogu yanjiusuo 青海省文物考古研究所, Guide xian kaogu diaocha jianbao 贵德县考古调查简报 [Archaeological survey report in Guide county]. QHWW 5, 1990. 16-23.

QHY 1990d

Qinghaisheng wenwu kaogu yanjiusuo 青海省文物考古研究所, Jianzha xian kaogu diaocha baogao 尖扎县考古调查报告 [Report of archaeological survey in Jianzha county]. QHWW 4, 1990, 47-56.

QHY 1991

Qinghaisheng wenwu kaogu yanjiusuo 青海省文物考古研究所, Qinghai Xunhua Hualong liangxian diaocha baogao 青海循化, 化隆两县调查报告 [Survey report of Xunhua and Hualong in Qinghai province]. KG 4, 1991, 313-318.

QHY 1993

Qinghaisheng wenwu kaogu yanjiusuo 青海省文物考古研究所, Qinghaisheng Minhe xian gu wenhua yicun diaocha 青海省民和县古文化遗存调查 [Survey of ancient cultures in Minhe county, Qinghai]. KG 3, 1993, 193-211.

QHY 1994a

Qinghaisheng wenwu kaogu yanjiusuo 青海省文物考古研究所, Qinghai Datong xian wenwu pucha jianbao 青海大通县文物普查简报 [Brief report of archaeological survey in Datong county, Qinghai]. KG 4, 1994, 320-328.

QHY 1994b

Qinghaisheng wenwu kaogu yanjiusuo 青海省文物考古研究所, Qinghai Huangzhong Xiaxihe Panjialiang Kayuewenhua mudi 青海湟中下西河潘家梁卡约文化墓地 [On one Kayue culture cemetery in Panjialiang, Xiaxihe, Huangzhong, Qinghai]. KGXJ 8, 1994, 28-97.

QHY 1998

Qinghaisheng wenwu kaogu yanjiusuo 青海省文物考古研究所, Qinghai Hualong xian Shangbanzhuwa Kayue wenhua mudi di er ci fajue 青海省化隆县上半主洼卡约文化墓地第

二次发掘 [The second excavation on Shangbanzhuwa graveyard of Kayue culture in Hualong county, Qinghai]. KG 1, 1998, 51-66.

QHY 1999a

Qinghaisheng wenwu kaogu yanjiusuo 青海省文物考古研究所, Qinghaisheng kaogu wushinian shuyao 青海省考古五十年述要 [Summary of fifty years of Qinghai archaeology]. In: Wushinian 99, 455-478, 455-478.

QHY 1999b

Qinghaisheng wenwu kaogu yanjiusuo 青海省文物考古研究所, Qinghaisheng Guide xian kaogu diao 青海省贵德县考古调查 [Survey in Guide county, Qinghai]. KGXJ 12, 1999, 1-19.

QHY 2002a

Qinghaisheng wenwu kaogu yanjiusuo 青海省文物考古研究所, Qinghai Pingan xian gucheng qingtong shidai he handai muzang 青海省平安县古城青铜时代和汉代墓葬 [The Bronze age and Han Dynasty age burials at Ping'an county in Qinghai]. KG 12, 2002, 29-37.

QHY 2002b

Qinghaisheng wenwu kaogu yanjiusuo 青海省文物考古研究所, Qinghai Datong Taojiazhai Qijia wenhua yizhi fajue jianbao 青海大通陶家寨齐家文化遗址发掘简报 [Brief report of the excavation of Kayue culture site at Taojiazhai, in Datong, Qinghai]. KYW supplement, 2002, 1-8.

QHY et al. 1994

Qinghaisheng wenwu kaogu yanjiusuo 青海省文物考古研究所 et al, Qinghai Datong xian Huangjiazhai mudi fajue jianbao 青海省大通县黄家寨墓地发掘报告 [Excavational report on Huangjiazhai graveyards of Datong county in Qinghai]. KG 3, 1994, 193-205.

QHY et al. 1996

Qinghaisheng wenwu kaogu yanjiusuo 青海省文物考古研究所 et al, Qinghai Hualong xian Banzhuwa Kayue wenhua muzang fajue jianbao 青海化隆县半主洼卡约文化墓葬发掘简报 [Brief report on the excavation of Kayue culture tombs at Banzhuwa in Hualong county, Qinghai]. KG 8, 1996, 27-44.

Qi T. G. 1989

Qi Tiangu 齐天谷, Shaanxi Yuchang xian chutu de Shangdai qingtongqi 陕西于长县出土的商代青铜器 [Bronzes discovered from the Yuchang county, in Shaanxi Province]. KYW 5, 1989.

Qi Y. H. 1962

Qi Yonghe 齐永贺, Neimenggu Baiyinhaote faxian de Qijia wenhua yiwu 内蒙古白音浩特发现的齐家文化遗物 [Qijia culture remains found at Baiyinhaote in Inner Mongolia]. KG 1, 1962, 22-30.

Qiao X. Q. 1992

Qiao Xiaolin 乔晓勤, Guanyu beifang youmu wenhua qi yuan de tantao 关于北方游牧民族起源的探讨 [On the origin of the northern nomadic people]. NMGWK 1&2, 1992, 21-25.

Qimaminzu 97

Dongjing guoli bowuguan 东京国立博物馆, Dacao yuan de qima minzu 大草原的骑马民族

[Horse-hiding People in Steppes] (Tokoyo 1997).

Qin/Sun/Han 2000

Qian Wei 潜伟/Sun Shuyun 孙淑云/Han Rubin 韩汝玢, *Gudai shentong zongshu 古代砷铜研究综述* [A review on ancient copper-arsenic alloys]. WBYKK 2, 2000, 48.

Qinghaicaitao 80

Qinghaisheng wenwu kaogudui 青海省文物考古队, *Qinghai caitao 青海彩陶* [Painted Pottery in Qinghai] (Beijing 1980).

Qingtongqi 1995

Zhongguo qingtongqi quanji bianji weiyuanhui 中国青铜器全集编辑委员会 (Ed.), *Zhongguo qingtongqi quanji 15. beifang mingzu 中国青铜器全集 15.北方民族* [Corpora of Chinese Bronzes 15. Northern People] (Beijing 1995).

Qiu S. H. et al. 1983

Qiu Shihua 仇士华 et al, Qiu Shihua, Cai Lianzhen etc. *Youguan suowei Xia wenhua de tanshi niandai ceding de baogao 有关所谓“夏文化”的碳十四年代测定的初步报告* [Primary report on the C14 dates of Xia Dynasty]. KG 10, 1983, 923-928.

QYB 1989

Qingyang diqu bowuguan 庆阳地区博物馆, *Gansu Ningxian Jiaocun Xigou chutu de yizuo xizhoumu 甘肃宁县焦村西沟出土的一座西周墓* [One Western Zhou tomb unearthed from Xigou, Jiao village, Ning county, Gansu]. KYW 6, 1989, 24-27.

Ren X. Y. 1994

Ren Xiaoyan 任小燕, *Pingan xian dongcun gu muzang ji yaozhi fajue jianbao 平安县东村古墓葬及窑址发掘简报* [Report of excavation at ancient burials and kilns of Dongcun in Ping'an county]. QHWW 8, 1994, 11-15.

Renfrew/Bahn 1991

Renfrew/Bahn, *Archaeological: Theories, Methods and Practice* (London 1991).

Rostovtzeff 1922

M. Rostovtzeff, *Irians and Greeks in South* (Russia 1922).

Rostovtzeff 1929

M. Rostovtzeff, *The Animal Style in South Russia and China* (Princeton 1929).

Ruan X. H. 1960

Ruan Xihu 阮西湖 (Interpreter), C. B. Jixieliefu tongxun yuanshi zai Beijing suozuo de xueshu baogao C.B.吉谢列夫通讯院士在北京所做的学术报告 [Academic report by Communication Academy C.B.Киселёв in Beijing]. KG 2, 1960, 45-53.

Salmony 1933

A. Salmony, *Sino-Siberian art in the collection of C.T. Loo* (Paris 1933).

Salmony 1934

A. Salmony, *Les plaquettes des bronze de Minoussinsk* (Paris 1934). In: *Gazette des Beaux-Arts*.

Samolin/Drew 1965

W. Samolin/I. M. Drew, Eurasian Animal Style Plaques I. In: Journal of Orient Studies Vol. XXIV, 170-183.

Sanshinian 79

Wenwu bianji weiyuanhui/文物编辑委员会 ed, Wenwu kaogu gongzuo sanshi nian (1948-1979) 文物考古工作三十年 [30 Years of Cultural Relics and Archaeology Work (1948-1979)] (Beijing 1979).

SAXZY 1984

Shaanxi Zhouyuan kaogudui 陕西周原考古队, Fufeng Liujia Jiangrong muzang fajue jianbao 扶风刘家姜戎墓葬发掘简报 [Brief report of excavation of Jiangrong tombs at Liujia, Fufeng]. WW 7, 1984, 16-29.

SBQ 1984

Su Bingqi 苏秉琦, Subingqi kaoguxue lunshu xuanji 苏秉琦考古学论述选集 [Collections of Su Bingqi on archaeology] (Beijing 1984).

SDB 1982

Suide xian bowuguan 绥德县博物馆, Shanxi Suide faxian he shoucang de Shangdai qingtongqi 陕西绥德发现和收藏的商代青铜器 [The bronzes of the Shang Dynasty unearthed and collected from Suide, in Shaanxi Province]. KGXJ 2, 1982, 41-43.

Shang M. J. 1985

Shang Minjie 尚民杰, Liuwan mudi shehui xingzhi ji jingji shenghuo de chubu tantao 柳湾墓地社会性质及经济生活的探讨 [Primary discussion on the social characteristic and economic life in Liuwan cemetery]. QHKH 12, 1985, 19-28.

Shang M. J. 1987

Shang Minjie 尚民杰, Qinghai yuanshi nongye kaogu gaisu 青海原始农业考古概述 [Summary of agriculture archaeology of Qinghai]. NYKG 1, 1987, 62-70.

Shang M. J. 1990

Shang Minjie 尚民杰, Qinghai Qiangren zaoqi lishi zhi wo jian 青海羌人早期历史之我见 [My opinion about the early history of Qiang People in Qinghai]. QHWW 5, 1990, 35-40.

Shao G. T. 1983

Shao Guotian 邵国田, Meimenggu Zhaowudameng Aohanqi Lijiayingzi chutu de shifan 内蒙古昭乌达盟敖汉旗李家营子出土的石范 [Stone mold unearthed from Lijiayingzi, Aohanqi, Zhaowudameng, Inner Mongolia]. KG 11, 1983, 1041-1042.

Shao G. T. 1992

Shao Guotian 邵国田, Aohanqi Tiejianggou zhanguo mudi diaocha jianbao 敖汉旗铁匠沟战国墓地调查简报 [Survey report of the Warring States cemetery at Tiejianggou, Aohanqi]. NMGWK 1/2, 1992, 84-90.

Shao G. T. 1993

Shao Guotian 邵国田, Neimengguzizhiqu Aohanqi faxian de qingtongqi jiqi youguan yiwu 内蒙古敖汉旗发现的青铜器及其有关遗物 [Bronze artifacts and other remains discovered in Aohanqi, Inner Mongolia]. BFWW 3, 1993, 16-23.

Shao W. P. 2001

Shao Wangping 邵望平, Kaoguxue shang suojian xizhou wangchao dui Haidai diqu de

- jinglue 考古学上所见西周王朝对海岱地区的经略 [Government of the Western Zhou Dynasty over the old states in the Haidai region]. YJXB 10, 2001, 71-107.
- Shen J. S. 1994
Shen Junshan 沈军山, Shi tan Shanrong de wenti zhuangshipin 试谈山戎的人体装饰品 [Discussion on the ornaments on the body of the Shanrong people]. BJWK 4, 1994, 116-122.
- Shen Y. 1993
Shen Yong 沈勇, Weifang san qi wenhua chulun 围坊三期文化初论 [On the Weifang III culture]. BFWW 3, 1993, 21-26.
- Shen Y. C. 1959
Shen Youcang 沈有仓, Hualong Xunhua Liangxian de huanghe yanan kaogu diaocha 化隆, 循化两县的黄河沿岸考古调查 [Survey along the Yellow river in Hualong and Xunhua county]. WW 4, 1959, 74.
- Shen Z. Z. 1972
Shen Zhenzhong 沈振中, Xin xian Liansigou chutu de qingtongqi 忻县连寺沟出土的青铜器 [Bronzes discovered from Liansigou, in Xin county]. WW 5, 1972, 67-68 .
- Shi P. J. et al. 1993
Shi Peijun 史培军/Wang Jing'ai 王静爱/ Guo Suxin 郭素新/ Suo Xiufen 索秀芬, Neimenggu nongmu jiaocuo didai huanjing kaogu yanjiu-Neimenggu kaogu wenhua fenbu yu ziran huanjing jiqi yanbian guanxi fenxi 内蒙古农牧交错地带环境考古研究-内蒙古考古文化分布与自然环境演变关系分析 [On the research of the archaeological environment in the agriculture and nomadic area in Inner Mongolia-on relations between the distribution of the archaeological cultures and evolution of the environment in Inner Mongolia]. NMGWK 1&2, 1993, 168-171.
- Shi T. 1961
Shi Tao 石陶, Huanghe xiayou de fuxi shizu shehui-Qijia wenhua shehui jingji xingtai de tansuo 黄河下游的父系氏族社会-齐家文化社会经济形态的探讨 [The patrilineal clan society in lower reaches of Yellow river-on the social and economic pattern of Qijia culture society]. KG 1, 1961, 3-11.
- Shi Y. T. et al. 1997
Shi Yintang 史银堂 et al, Neimengguzhiqu Tuyouqi faxian yijian zhanguo shiqi qingtongdao 内蒙古土右旗发现一件战国时期青铜刀 [One bronze knife found from Tuyouqi, Inner Mongolia]. KG 11, 1997, 18.
- Shi/Bian 2002
Shi Guangfeng 史广峰/Bian Zhijie 边质洁, Jixian zhangjiayuan Shangzhou yicun de zusu wenti 莒县张家园商周遗址遗存的族属问题 [On the people of the remains from Zhangjiayuan, Ji county during the Shang and Zhou period]. WWCQ 4, 2002, 26-29.
- Shinian 91
Wenwu jiweihui 文物辑委员会, Wenwu kaogu gongzuo 10 nian 1979-1989 文物考古工作十年 1979-1989 [Ten Years of Archaeological work] (Beijing, 1991).
- Shinianhai 96
Shangguan hongnan 上关鸿南/Zhu Shiguang 朱世光 (ed.), Shinianhai xiansheng bashi shoucheng xueshu wenji 史念海先生 80 寿辰学术文集 [Collected Academic Work for the

Eightieth Birthday of Mr. Shinianhai] (Shaanxi 1996).

Shouhuo 1976

Beijingshi wenwu guanli weiyuanhui 北京市文物管理处, Beijing diqu de you yi zhongyao kaogu faxian 北京地区的又一重要考古收获 [Another important archaeological discover in Beijing region]. KG 4, 1976, 246-258.

Shui T. 2001a

Shui Tao 水涛, Ganqing diqu qingtong shidai de wenhua jiegou he jingji xingtai yanjiu 甘青地区青铜时代的文化结构和经济形态研究 [Cultural framework and economic pattern of the Bronze Age in Gansu and Qinghai region] In: Xibeiqingtong 2001, 193-327.

Shui T. 2001b

Shui Tao 水涛, Guanyu Siwa wenhua yanjiu de jige wenti 关于寺洼文化研究的几个问题 [On the problems in the research of the Siwa culture]. In: Xibeiqingtongqi 2001, 110-114.

Shun/Liu 1992

Shun Mingsheng /Liu Guoning 刘国宁, Hainanzhou Gonghe Xinghai liangxian kaogu diaocha baogao 海南州共和, 兴海两县考古调查简报 [Survey in Gonghe and Xinghai, Hainanzhou]. QHWW 7, 1992, 32-39.

SK 2001

Su Bai 宿白 ed., Suqingqi yu dangdai zhongguo kaoguxue 苏秉琦与当代中国考古学 [Subingqi and present Chinese Archaeology] (Beijing 2001).

SLW 1972

Shilou xian renmin wenhuaguan 石楼县人民文化馆, Shanxi Shilou Yidie faxian Shangdai tongqi 山西石楼义碟发现商代铜器 [The Shang bronzes discovered in Yidie, Shilou, Shanxi]. KG 4, 1972, 29-30.

Song X. C. 1997

Song Xinchao 宋新潮, Zhongguo zaoqi tongjing yiji xianguan wenti 中国早期铜镜以及相关问题 [On the early Chinese bronze mirrors and related questions]. KGXB 2, 1997, 147-169.

Song Z. M. 1997

Song Zhimin 宋治明, Sanchage tongbing tiejian jiqi xianguan wenti de tantao 三叉格铜柄铁剑及相差问题探讨 [Discussion on iron sword with trifurcate shaft]. KG 12, 1997, 50-59.

Su B.Q. 1984

Su Bingqi 苏秉琦, Doujitaigou dongqu muzang 斗鸡台沟东区墓葬 [Burials in east Doujitaigou]. In: SBQ 1984, 143-189.

Su H. 1982

Su He 苏赫, Cong Zhaomeng faxian de daxing qingtongqi shilun beifang de zaoqi qingtong wenming 从昭盟发现的大型青铜器试论北方的早期青铜文明 [Discussion on the early northern bronze civilization based on the big bronzes found from Zhaomeng]. NMGWK 2, 1982, 1-5.

Su/Yin 1981

Su Bingqi 苏秉琦/Yin Weizhang 殷玮璋, Guanyu kaoguxue wenhua de quxi leixing wenti 关于考古学文化的区系类型问题 [Differentiation of archaeological culture]. WW 5, 1981, 10-17.

Sun D. H. 1962

Sun Dehai 孙德海, Handan Baijiacun zhanguo mu 邯郸百家村战国墓 [Warring States burials at Baijiacun, Handan]. KG 12, 1962, 613-634.

Sun H. 2003

Sun Hua 孙华, Zhongguo qingtong wenhua tixi de jige wenti 中国青铜文化体系的几个问题 [Some problems on the system of Chinese bronze cultures]. KY 5, 2003, 921-948.

Sun J. 1986

Sun Ji 孙机, Woguo gudai de gedai 我国古代的革带 [Ancient leather belt in China]. in: WKW (Beijing 1986), 297-321.

Sun S. D. 1960

Sun Shoudao 孙守道, Xiongnu xichagou wenhua gu muqun de faxian 匈奴西岔沟文化古墓群的发现 [Discoveries of ancient Xichagou culture of Xiongnu]. WW 8-9, 1960, 25-86.

Sun S. Y. 1998

Sun Shuyun 孙淑云, Donghuishan yizhi Siba wenhua tongqi de jiangding ji yanjiu 东灰山遗址四坝文化铜器的鉴定及研究 [Identification and investigation of Siba-culture bronze in Donghuishan site]. In: Donghuishan 98, 194.

Sun Z. Y. 2002

Sun Zhouyong 孙周勇, Hetao diqu shiqian kaoguxue shi chubu yanjiu 河套地区史前考古学史初步研究 [Primary research on the history of the archaeology in ancient Hetao region]. WB 6, 2002, 53-61.

Sun/Han 1981

Sun Shuyun 孙淑云 / Han Rubin 韩汝玢, Zhongguo zaoqi tongqi de chubu yanjiu 中国早期铜器的初步研究 [A Preliminary study of early Chinese copper and bronze artifacts]. KGXB 3, 1981, 287-301.

Sun/Han 1997

Sun Shuyun 孙淑云 / Han Rubin 韩汝玢, Gansu zaoqi tongqide faxian yu yelian, zhizuo jishu de yanjiu 甘肃早期铜器的发现与冶炼, 制作技术的研究 [Studies of Early Bronzes Objects from Gansu in Terms of casting and manufacturing Techniques]. WW 7, 1997, 75-84.

Sun/Kennon 1992

Sun Shuyun 孙淑云 / N.F.Kennon, Zhongguo gudai tongjing xianwei zuzhi de yanjiu 中国古代铜镜显微组织的研究 [Research on the microstructure of the ancient Chinese bronze mirrors]. ZKY 1, 1992, 54.

Sun/Qian 2002

Sun Shunyun 孙淑云/Qianwei 潜伟, Gudai Tong, Shentong he qingtong de shiyong yu jixie xingneng zongshu 古代铜, 砷铜和青铜的使用与机械性能综述 [A review on early use and mechanical properties of copper, arsenic copper and bronze]. YJL 3A, 2002, 144-149.

SXK 1983

Shanxi sheng kaogu yanjiusuo 山西省考古研究所, Shanxi Hunyuan xian Liyucun dongzhou mu 山西浑源县李峪村东周墓 [The Eastern Zhou tombs found in Liyu village, Hunyuan county, Shanxi Province]. KG 8, 1983, 695-700.

SXK 1984

Shanxi sheng kaogu yanjiusuo 山西省考古研究所, Shanxi Changzi dongzhou mu 山西长子东周墓 [The Eastern Zhou tombs in Changzi, Shanxi]. KGXB 4, 1984, 16-19.

SXSZQTQ 1979

Shaanxi sheng kaogu yanjiusuo 陕西省考古研究所 et al. , Shannxi chutu Shang Zhou qingtongqi 陕西出土商周青铜器 [Bronzes of the Shang and Zhou unearthed from Shaanxi] (Beijing 1979).

SXW 1958

Shanxi sheng wenwu guanli weiyuanhui baoguanzu 山西省文物管理委员会保管组, Shanxi Shilou xian Erlangpo chutu Shangzhou tongqi 山西石楼县二郎坡出土商周铜器 [Bronzes of the Shan and Zhou Dynasty discovered from Erlangpo, Shilou county, Shanxi Province]. WWCZ 1, 1958, 36-37.

SXY et al. 1986

Shanxisheng wenwu kaogu yanjiusuo 山西省文物考古研究所, Shanxi Lingshi Jingjiecun Shangmu 山西灵石旌介村商墓 [Burials of Shang dynasty in Jingjie village, Linshi, Shanxi]. WW 1, 1986, 1-18.

SZKG

Beijing daxue lishixi kaoguxi jiaoyanshi Shangzhou zu 北京大学历史系考古教研室商周组, Shangzhou kaogu 商周考古 [Archaeology of the Shang and Zhou] (Beijing 1979).

Takashi Okazaki 1954

Takashi Okazaki 岡崎敬, 北方系铜剑と中国式铜剑 [Chinese style bronze swords in the northern style bronze swords] (Tokyo 1954).

Ta/Liang 1980

Ta La 塔拉/Liang Jingming 梁京明, Hulusitai Xiongnu mu 呼鲁斯太匈奴墓 [The Xiongnu tombs at Hurusitai]. WW 7, 1980, 11-18.

Takahama Shyu 1983

Takahama Shyu 高浜秀, Eersuosi qingtong duanjian de xingshi fenlei [Classification of the forms of Ordos short bronze sword] . In: 东京国立博物馆纪要 Summery of Tokyo National Museum 18.

Tang J. G. 1999

Tang Jigen 唐际根, Zhongshang wenhua yanjiu 中商文化研究 [Research on Middle-Shang culture]. KGXB 4, 1999, 393-420.

Tang L. 1973

Tang Lan 唐兰, Gongxingqi(tong gong bi) yongtu kao 弓形器（铜弓秘）用途考 [Research on the function of bow-shaped ware]. KG 3, 1973, 178-184.

Tang L. 1979

Tang Lan 唐兰, Zhongguo qingtongqi de qi yuan he fazhan 中国青铜器的起源与发展 [The origin and develepment of Chinese bronzes]. GGYK 1, 1979, 6-12.

Tang Y. M. 1982

Tang Yunming 唐云明, Hebei jing nei jichu Shangdai wenhua yicun jilue 河北境内几处商代文化遗存纪略 [On some remains of the Shang culture within Hebei region]. KGXJ 2, 1982,

44-46.

Tao Z. Y. 1985

Tao Zongye 陶宗冶, Hebei Zhangjiakou shi kaogu diaocha baogao 河北张家口市考古调查报告 [Survey at Zhangjiakou, Hebei]. KYW 6, 1985, 13-20.

Tao Z. Y. 1987

Tao Zongye 陶宗冶, Hebei Xuanhua xian Xiaobaiyang mudi fajue baogao 河北宣化县小白杨墓地发掘简报 [Report of excavation at Xiaobaiyang cemetery in Xuanhua county, Hebei]. WW 5, 1987, 41-49.

Tao Z. Y. 1990

Tao Zongye 陶宗冶, Hebei Xuanhua Lidarenzhuang yizhi shijue baogao 河北宣化李大人庄遗址试掘报告 [Tentative excavation at the Lidarenzhuang site in Xuanhua, Hebei]. KG 5, 1990, 398-402.

Tian G. J. 1976

Tian Guangjin 田广金, Taohongbala de xiongnu mu 桃红巴拉的匈奴墓 [Xiongnu tombs at Taohongbala]. KGXB 4, 1976, 131-143.

Tian G. J. 1982

Tian Guangjin 田广金, Xiongnu muzang de leixing he niandai 匈奴墓葬的类型和年代 [The types and date of the Xiongnu tombs]. NMGWK 2, 1982, 8-17.

Tian G. J. 1983

Tian Guangjin 田广金, Jinnianlai Neimenggu diqu de xiongnu kaogu 近年来内蒙古地区的匈奴考古 [Recent Xiongnu archaeology in Inner Mongolia]. KGXB 1, 1983, 7-24.

Tian G. J. 1986

Tian Guangjin 田广金, Taohongbala muqun 桃红巴拉墓群 [Taohongbala Cemetery]. In: Ordos 86, 203-219.

Tian G. J. 1991

Tian Guangjin 田广金, Neimenggu zhongnanbu yangshao shidai wenhua yicun yanjiu 内蒙古中南部仰韶时代文化遗存研究 [Research of the Yangshao culture remains in middle south of Inner Mongolia]. In: NMGZN 91, 55-85.

Tian G. J. 1992

Tian Guangjin 田广金, Neimenggu xinshiqi shidai-qingtong shidai kaogu faxian yu yanjiu 内蒙古新石器时代-青铜时代考古发现与研究 [Discovery and research on the Neolithic and Bronze Age of the Inner Mongolia]. NMGWK 1&2, 1992, 1-20.

Tian G. J. 1993

Tian Guangjin 田广金, Neimenggu changcheng didai zhu kaoguxue wenhua yu linjing tongqi wenhua xianghu yingxiang guilv de yanjiu 内蒙古长城地带诸考古学文化与邻境同期文化相互影响规律的研究 [The research on the rule of the mutual relations between the cultures along the ancient Great Wall and the neighboring cultures]. NMGWK 1-2, 1993, 16-22.

Tian G. J. 1997a

Tian Guangjin 田广金, Zhongguo beifang changcheng didai huangjing kaoguxue de chubu yanjiu 中国北方长城地带环境考古学的初步研究 [The primary study on the archaeological

environment of the Great Wall regions in northern China]. NMGWK 2, 1997,44-51.

Tian G. J. 1997b

Tian Guangjin 田广金, Zhongguo beifangxi qingtongqi wenhua he leixing de chubu yanjiu 中国北方系青铜器文化和类型的初步研究 [Primary study on the northern bronze cultures and its type]. KWL 4, 1997, 266-307.

Tian S. H. 1995

Tian Shuhua 田淑华, Yanbei Chengde diqu kaogu chengguo gaishu yu sikao 燕北承德地区考古成果概述与思考 [Summery and thoughts on the archaeological achievements in the Chengde region, north of the Yanshan]. BFWW 2, 1995, 48-52.

Tian/Guo 1980

Tian Guangjin 田广金 / Guo Su xin 郭素新, Neimenggu Aluchaideng faxian de Xiongnu yiwu 内蒙古阿鲁柴灯发现的匈奴遗物 [The Xiongnu remains found from Aluchaideng, Inner Mongolia]. KG 4, 1980, 333-338.

Tian/Guo 1986

Tian Guangjin 田广金/Guo Suxin 郭素新, E'erdusi qingtongqi de qi yuan 鄂尔多斯青铜器的起源 [The origin of Ordos bronzes]. In: Ordos 86, 185-196.

Tian/Guo 1997

Tian Guangjin 田广金/Guo Suxin 郭素新, Beifang wenhua yu caoyuan wenming 北方文化与草原文明 [Northern cultures and steppe civilization]. NMGWKW 2, 1997, 1-11.

TJLBK 1984

Tianjin shi lishi bowuguan kaogudui 天津市历史博物馆考古队, Tianjian Jixian Zhangjiayuan yizhi di er ci fajue 天津蓟县张家园遗址第二次发掘 [The second excavation at Zhangjiayuan site, Ji county, Tianjin]. KG 8, 1984, 698-705.

TJLBK 1991

Tianjin shi lishi bowuguan kaogubu 天津市历史博物馆考古部, 1979-1989 nian Tianjin wenwu kaogu xin shouhuo 1979-1989年天津文物考古新收获 [New archaeological achievements in Tianjin during 1979-1989]. In: WK10, 14-24.

TJLBK 1993

Tianjin shi lishi bowuguan kaogubu 天津市历史博物馆考古部, Tianjin Jixian Zhangjiayuan yizhi di san ci fajue 天津蓟县张家园遗址第三次发掘 [The third excavation at Zhangjiayuan site, Ji county, Tianjin]. KG 4, 1993, 311-323.

TJLBK 2001

Tianjin shi lishi bowuguan kaogubu 天津市历史博物馆考古部, Ji xian Qingchi xinshiqi shidai ji Shang Zhou yizhi 蓟县青池新石器时代及商周遗址 shangzhou [Archaeology of the Neolithic and Bronze Age at Qingchi, Ji county]. In: ZKN 99, 96-97.

TJLBK et al. 1988

Tianjin shi lishi bowuguan kaogubu 天津市历史博物馆考古部 et al., Ji xian Bangjun xizhou shiqi yizhi he muzang 蓟县邦均西周时期遗址和墓葬 [Sites and burials of the Western Zhou period from Bangjun, Ji county]. In: Nianjian 87, 98.

TJLBK et al. 1991

Tianjin shi lishi bowuguan kaogudui 天津市历史博物馆考古队 et al., Tianjin Baodi xian Niudaokou yizhi diaocha fajue jianbao 天津宝坻县牛道口遗址调查发掘简报 [Brief report of excavation at Niudaokou, Baodi county, Tianjin]. KG 7, 1991, 577-586.

TJW 1979

Tianjinshi wenwu guanlichu 天津市文物管理处, Tianjian Jixian Zhangjiayuan yizhi shijue jianbao 天津蓟县张家园遗址发掘简报 [Excavation at Zhangjiayuan site, Ji county, Tianjin]. WWZC 1, 1979, 163-171.

TJWK 1983

Tianjinshi wenwu guanlichu kaogudui 天津市文物管理处考古队, Tianjin Jixian Weifang yizhi fajue baogao 天津蓟县围坊遗址发掘报告 [Excavation at Weifang, in Ji county, Tianjin]. KG 10, 1983, 877-893.

Tong E. Z. 1987

Tong Enzheng 童恩正, Shilun woguo cong dongbei zhi xinan de biandi banyuexing wenhua chuanbodai 试论我国从东北至西南的边地半月形文化传播带 [On the crescent frontier belt of cultural transmission from northeast to westsouth of China]. In: WKLJ 87:17-43. 文物与考古论集 Papers of cultural relics and archaeology, 17-36.

Tong Z. C. 1963

Tong Zhuchen 佟柱臣, Jilin Xituanshan shiguanmu fajue baogao 吉林西团山石棺墓发掘报告 [Excavations of cist tombs at Xituanshan, Jilin]. KGXB 1, 1964, 29-49.

Tong Z. C. 2001

Tong Zhuchen 佟柱臣, Zhongguo dongbei diqu neimenggu diqu he chaoxian beibu qingtong duanjian de yanjiu 中国东北地区内蒙古地区和朝鲜北部青铜短剑的研究 [Research on short bronze swords in northeast China, Inner Mongolia region and North Korea]. WW 8, 2001, 46-54.

Tregear 1965

T. R. Tregear, A geography of China (Chicago 1965).

TSW et al. 1997

Tangshan shi wenwu guanlichu 唐山市文物管理处 et al., Hebei Qianan xian xiaoshandongzhuang xizhou shiqi muzang 河北迁安县小山东庄西周时期墓葬 [The Western Zhou tombs found from Xiaoshandongzhuang, Qian'an county, Hebei]. KG 4, 1997, 58-62.

Umehara Sueji 1938

Umehara Sueji 梅原末治, 古代北方系文物の研究 [Research on the ancient northern style remains] (Tokyo 1938).

Wagner 2001

M. Wagner, Kayue-ein Fundkomplex des 2. Jahrtausende v.Chr. Am Nordwestrand des chinesischen Zentralreiches. In: Migration und Kulturtransfer 2001, 37-56.

Wang B. H. 1986

Wang Binghua 王炳华, Xinjiang dongbu faxian de jipi tongqi 新疆东部发现的几批铜器 [Some bronzes found from the eastern Xinjiang]. KG 10, 1986, 887-890.

Wang B. Q. 1998

- Wang Baoquan 汪保全, Gansu Tianshuishi chutu xizhou qingtongqi 甘肃天水市出土西周青铜器 [The Western Zhou bronzes unearthed from Tianshui county, Gansu Province]. KYW 3, 1998, 82-83.
- Wang D. 1992
Wang Dan 王丹, Jilin daxue guancang beifang qingtongqi 吉林大学馆藏北方青铜器 [Northern bronzes collected by Jilin University]. BFWW 3, 1992, 16-23.
- Wang F. 1990
Wang Feng 王峰, Hebei Xinglongxian faxian Shangzhou qingtongqi jiaocang 河北兴隆县发现商周青铜器窖藏 [Bronze hoard of Shangzhou Dynasty found in Xinglong, Hebei]. WW 11, 1990, 57-58.
- Wang G. 1994
Wang Gang 王刚, Linxi xian faxian Ordos tongfu 林西县发现鄂尔多斯式铜鍍 [Bronze Fu-cookingware found from Linxi county]. NMGWK 1, 1994, 133.
- Wang G. 1997
Wanggang 王刚, Linxixian Susitai Xianbei muzang 林西县苏泗汰鲜卑墓葬 [Xianbei tomb at Susitai, Linxi county]. NMGWKW, 1997, 461-462.
- Wang G. 1998
Wang Gang 王刚, Linxixian Jinggouzi Xiajiadian shengceng wenhua muzang 林西县井沟子夏家店上层文化墓葬 [The Upper Xiajiadian culture tombs at Jinggouzi, Linxi county]. NMGWK, 1998, 1-4.
- Wang G. D. 1995
Wang Guodao 王国道, Xining Shenna yizhi 西宁沈那遗址 [Shenna site in Xining] .In: Nianjian 93, 1995, 260-261].
- Wang G. S. 1990
Wang Guoshun 王国顺, Guinan Tongde liangxian kaogu diaocha jianbao 贵南, 同德两县考古调查简报 [Archaeological survey report of Guinan, Tongde county]. QHWW 4, 1990, 57-70.
- Wang J. H. 1989
Wang Jihuai 王吉怀, Qijia wenhua muzang de jizhong maizang fangshi 齐家文化墓葬的几种埋葬方式 [On several burial manners of the Qijia culture]. KYW 6, 1989, 47-55.
- Wang K. L. 1983
Wang Kelin 王克林, Shilun Qijia wenhua yu Jinnan longshan wenhua de guanxi 试论齐家文化与晋南龙山文化的关系 [Discussion on the relations between Qijia culture and Longshang culture in south Shaanxi]. SQYJ 2, 1989, 70-80.
- Wang L. X. 2004a
Wang Lixin 王立新, Liao xi qu Xia zhi Zhanguo shiqi wenhua geju yu jingji xingtai de yanjin 辽西区夏至战国时期文化格局与经济形态的演进 [The cultural framework and economical evolution of West Liaoning region from Xia to the Warring States Period]. KGXB 3, 2004, 243-269.
- Wang L. X. 2004b
Wang Lixin 王立新, Shi lun changcheng didai zhongduan qingtong shidai wenhua de fazhan

试论长城地带中段青铜时代文化的发展 [On development of the bronze cultures distributed in middle Great Wall]. In: ZZP70, 2004, 365-385.

Wang L. X. et al. 2004

Wang Lixin 王立新 et al, Ee ling ling er nian Neimenggu Linxixian Jinggouzi yizhi xiqu muzang fajue jiyao 2002 年内蒙古林西县井沟子遗址西区墓葬发掘纪要 [The excavation of 2002 at the burials in west Jinggouzi, Linxi county, Inner Mongolia]. KYW 1, 2004, 6-18.

Wang M. F. 1998

Wang Miaofa 王妙发, Qinghaisheng Majiayao wenhua juluo guimo kaocha 青海省马家窑文化聚落规模考察 [On the scale of Majiayao culture settlement patterns in Qinghai Province]. In: Qingguoji 98, 85-99.

Wang Q. J. 1990

Wang Quanjia 王全甲, Longdexian chutu de Xiongnu wenwu 隆德县出土的匈奴文物 [The Xiongnu remains unearthed from Longde county]. KYW 6, 1990, 5-7.

Wang R. X. 1982

Wang Renxiang 王仁湘, Gudai daigou yongtu kao 古代带钩用途考 [Research on the function of the belt hook]. WW 10, 1982, 75-82.

Wang W. 1990

Wang Wu 王武, Qinghai Gangcha xian Kayue wenhua mudi fajue jianbao 青海刚察县卡约文化墓地发掘简报 [Brief report of the excavation of Kayue culture cemetery in Gangcha county, Qinghai]. QHWW 4, 1990, 15-21.

Wang W. 1992

Wang Wu 王武, Haibeizhou wenwu pucha jianbao 海北州文物普查简报 [A brief report of survey at Haibeizhou]. QHWW 7, 1992, 27-31.

Wang W. X. 1994

Wang Weixiang 王未想, Neimenggu Lindong Tazigou chutu de yangshou tongdao 内蒙古林东塔子沟出土的羊首铜刀 [Sheep-headed knife unearthed from Tazigou, Lindong, Inner Mongolia]. BFWW 4, 1994, 31.

Wang Y. Y. 1950

Wang Yongyan 王永焱, Xibei shiqian wenhua yizhi gaikuang 西北史前文化遗址概况 [Prehistoric cultural sites in west-north China]. WWCZ 10, 1950, 155-165.

Wang Z. 2006

Wang Zhen 王振, Cong Qijia wenhua tongqi fenxi kan zhongguo zaoqi tongqi de qi yuan yu fazhan 从齐家文化铜器分析看中国早期铜器的起源与发展 [The research on origins and development of early copper objects in China from the analysis of the copper objects in Qijia culture] (Jilin Universtiy 2006). Master Thesis.

Wang Z. Z. 2006

Wang Zhenzhong 王震中, Zhongshang wenhua gainian de yiyi jiqi xiangguan wenti 中商文化概念的意义以及相关问题 [The meaning of the concept of Middle-Shang and its related questions]. KYW 1, 2006, 44-49.

Wang/Bu 1998

Wang Lixin 王立新/Bu Jida 卜箕大, Dui Xiajiadian xiaceg wenhua yuanliu ji yu qita

wenhua guanxi de zai renshi 对夏家店下层文化源流及与其他文化关系的再认识 [Origin and offspring of the Lower Xiajiadian culture and its relations with other cultures]. In: QGJ 98, 180-187.

Wang/Hou 1991

Wang Hangang 王韩钢/Hou Ningbin 侯宁彬, Shilun Zhongguo gudai qingtongqi de qiyuan 试论中国古代青铜器的起源 [Discussion on the origin of ancient Chinese bronzes]. KYW 2, 1991, 70-75.

Wang/Liu 1987

Wang Guodao 王国道/Liu Guoning 刘国宁, Xunhua xian gu wenhua yizhi fenbu gaikuang 循化县古文化遗址分布概况 [Distribution of ancient cultural sites in Xunhua county]. QHWW 3, 1987, 22-27.

Wang/Shui 1997

Wang Zhankui 王占奎 /Shui Tao 水涛, Gansu Heshui Jiuzhan yizhi fajue baogao 甘肃合水九站遗址发掘报告 [Report of excavation at Jiuzhan, Heshui, Gansu]. KY 3, 1997, 300-460.

Wanjiashai

Xu Hong 旭红/Wang Dafang 王大方 ed., Wanjiashai shuili shuniu gongcheng kaogu baogao ji 万家寨水利枢纽工程考古报告集 [Archaeological papers of the Wanjiashai water control project] (Huhehaote 2001).

Waston 1985

W. Waston, An interpenetration of Pre-Han bronze metallurgy in west China. Proceedings of the British Academy 20, 1984, 327-358.

Wei/Cui 1994

Weijian 魏坚/Cui Xuan 崔璿, Neimenggu zhongnanbu yuanshi wenhua de faxian yu yanjiu 内蒙古中南部原始文化的发现与研究 [Discovery and research on the ancient cultures in middle and south of the Inner Mongolia]. NMGWKW 1, 1994, 125-143.

White 1956

W. Ch. White, Bronze culture of Ancient China (Toronto 1956).

WK10

Wenwu bianji weiyuanhui 文物编辑委员会 ed., Wenwu kaogu gongzuo shinian 文物考古工作十年 [Ten years of archaeological work] (Beijing 1991).

WKLJ 87

Wenwu chubanshe bianjibu 文物出版社编辑部, Wenwu chubanshe chengli sanshi zhounian jinian--Wenwu yu kaogu lunji 文物出版社成立三十周年纪念—文物与考古论集 [The Thirtieth Anniversary of the Cultural Relics Publishing House-Treatises on Archaeology and Cultural] (Beijing 1987).

WKW

Wenwu chubanshe bianjibu 文物出版社编辑部 ed., Wenwu yu kaogu wenji 文物与考古文集 [Treatise on archaeology and cultural] (Beijing 1986).

WLB et al. 1997

Wulanchabumeng bowuguan 乌兰察布盟博物馆 et al, Qingshuihexian Zhuangwoping yizhi fajue jianbao 清水河县庄窝坪遗址发掘简报 [Brief report on the excavation of

Zhuangwoping, at Qingshuihe county]. In: NMGWKW 2, 1997.

WLX 98

Wang Lixin 王立新, Zaoshang wenhua yanjiu 早商文化研究 [Research on Early Shang culture] (Beijing 1998).

WR 2001

Wang Ran 王然, Zhongguo wenwu dadian 中国文物大典 [Chinese Cultural Relics Dictionary] (Beijing 2001).

Wu E. 1978

Wu En 乌恩, Guanyu woguo beifang de qingtong duanjian 关于我国北方的青铜短剑 [On short bronze swords in northern China]. KG 5, 1978, 324-333.

Wu E. 1981

Wu En 乌恩, Woguo beifang gudai dongwu wenshi 我国北方古代动物纹饰 [Ancient animal motifs in northern China]. KGXB 1, 1981, 45-61.

Wu E. 1983

Wu En 乌恩, Zhongguo beifang qingtong toudiao daishi 中国北方青铜透雕带饰 [Enchased bronze strip-ornament in northern China]. KGXB 1, 1983, 25-37.

Wu E. 1984

Wu En 乌恩, Lun woguo beifang gudai dongwu wenshi de qi yuan 论我国北方古代动物纹饰的起源 [Discussion on the origin of animal motifs in northern China]. KYW 4, 1984, 46-58.

Wu E. 1985

Wu En 乌恩, Yin zhi zhou chu de bei fang xi qing tong qi 殷至周初的北方系青铜器 [The bronzes of northern China from the late Shan Dynasty to the early Western Zhou Dynasty]. KGXB 2, 1985, 135-155.

Wu E. 1986

Wu En 乌恩, Zhongguo beifang qingtong wenhua yu kalasuke wenhua de guanxi 中国北方青铜文化与卡拉苏克文化的关系 [Relationship between northern bronze cultures in China and Karasuk culture]. In: XN 86 (Beijing 1986), 135-150.

Wu E. 1990

Wu En 乌恩, Lun Xiongnu kaogu zhong de jige wenti 论匈奴考古中的几个问题 [Some problems of the archaeology of the Xiongnu]. KGXB 4, 1990, 409-436.

Wu E. 1992

Wu En 乌恩, Dongzhou shiqi beifang shaoshu minzu wenhua yicun shixi 东周时期北方少数民族文化遗存试析 [Tentative analysis of cultural remains of minorities during Eastern Zhou period BJWW 3, 1992]. BJWK 3, 1992, 149-161.

Wu E. 1993

Wu En 乌恩, Xiajiadian Shangceng wenhua yishu tantao 夏家店上层文化艺术探讨 [Discussion on the art in the upper Xiajiadian culture]. NMGWK 1&2, 1993, 81-88.

Wu E. 1994a

Wu En 乌恩, Luelun guaiyi dongwu wenyang ji xiangguan wenti 略论诡异动物纹样及相关

问题 [Discussion on weird animal motifs and related questions]. GGYK 3, 1994, 27-30.

Wu E. 1994b

Wu En 乌恩, Lun gudai zhanche jiqi xiangguan wenti 论古代战车及其相关问题 [Discussion on ancient carriage and related questions]. NMGWK 1, 1994, 327-335.

Wu E. 2002a

Wu En 乌恩, Ouya dalu caoyuan zaoqi youmu wenhua de jidian sikao 欧亚大陆草原早期游牧文化的几点思考 [Several thoughts on early nomadic culture in Eurasian Steppes]. KGXB 4, 2002, 437-470.

Wu E. 2002b

Wu En 乌恩, Lue lun ouya dalu caoyuan juanqu dongwu wenyang ji xiangguan wenti 略论欧亚大陆草原卷曲动物纹样及相关问题 [Discussion on curl-shaped patterns in the Eurasian Steppes and related questions]. KG 11, 2002, 60-68.

Wu H. X. 1994

Wu Hengxiang 吴恒祥, Yuedu xian Hongshuixiang gu wenhua yizhi diaocha jianbao 乐都县洪水乡古文化遗址调查简报 [Brief report on the survey of ancient cultural sites in Hongshui countyside, Yuedu county]. QHWW 8, 1994, 7-11.

Wu P. 1992

Wu Ping 吴平, Yushu, Guoluozhou wenwu pucha jianbao 玉树, 果洛州文物普查简报 [Brief report of survey in Yushu and Guoluozhou]. QHWW 7, 1992, 59-68.

Wu R. Z. 1961

Wu Ruzuo 吴汝作, Ganqing diqu yuanshi wenhua de gaimao jiqi xianghu guanxi 甘青地区原始文化的概貌及其相互关系 [The relations between the ancient cultures in Gansu and Qinghai region]. KG 1, 1961, 12-19.

Wu R. Z. 1974

Wu Rongzeng 吴荣增, Helingeer Hanmu bihua zhong suo fangyin de donghan shehui shenghuo 和林格尔汉墓壁画中所反映的东汉社会生活 [Life in the Eastern Han society as reflected in wall paintings of the Han tombs at Helinger, Inner Mongolia]. WW 1, 1974, 24-30.

Wu R. Z. 1983

Wu Ruzuo 吴汝作, Qijia wenhua muzang chubu pouxi 齐家文化墓葬初步剖析 [Preliminary analysis on the burials of the Qijia culture]. SQYJ 2, 1983, 58-69.

Wu R. Z. 1999

Wu Ruzuo 吴汝作, Lue lun Nuomuhong wenhua 略论诺木洪文化 [Discussion on Nuomuhong culture]. In: QHWUSHINIAN 99, 120-126.

Wu Z. L. 1972

Wu Zhenlu 吴振录, Baodexian xin faxian de Yindai qingtongqi 保德县新发现的殷代青铜器 [New discoveries of Yin bronzes at Baode county]. WW 4, 1972, 62-67.

Wu/Shang 1980

Wu Zhenfeng 吴镇峰/Shang Zhiru 尚志儒, Shaanxi Fengxiang Baqitun qingguo muzang fajue jianbao 陕西凤翔八旗屯秦国墓葬发掘简报 [Brief report on the excavation of Qin State tombs at Baqitun, Fengxiang, Shaanxi]. WWZC 3, 1980, 67-79.

Wushinian 99

Wenwu chubanshe 文物出版社 (ed.), Xinzhongguo kaogu wushinian (1949-1999) 新中国考古五十年 (1949-1999) [Fifty Years of Archaeological Work of New China (1949-1999)] (Beijing 1999).

Xia N. 1977

Xia Nai 夏鼐, Tan shisi Ceding niandai he zhongguo shiqian kaoguxue C14 测定年代和中国史前考古学 [Carbon 14 dating and Chinese prehistory archaeology]. KG 4, 1977, 217-232.

Xia N. 1985

Xia Nai 夏鼐, Zhongguo wenming de qiyuan 中国文明的起源 [On the origin of Chinese civilization]. WW 8, 1985, 1-8.

Xia N. 2000

Xia Nai 夏鼐, Lintao Siwanshan fajue ji 临洮寺洼山发掘记 [Excavation at Siwanshan, Lintao]. XN 2000, 269-310.

Xiang/Li 1995

Xiang Chunsong 项春松/ Li Yi 李义, Ningcheng Xiaoheishigou shiguomu diaocha qingli jianbao 宁城小黑石沟石椁墓调查清理报告 [Excavation of a stone-chambered tomb at Xiaoheishigou, Ningcheng, Inner Mongolia]. WW 5, 1995, 4-22.

Xiawenhua 96

Zhonghua shuju 中华书局, Xia wenhua yanjiu lunji 夏文化研究论集 [Collection of the Research on Xia culture] (Beijing 1996).

Xibeiqingtong 2001

Shui Tao 水涛, Zhongguo xibei diqu qingtong shidai kaogu lunji 中国西北地区青铜时代考古论集 [Papers on the Bronze Age Archaeology in West-northern China] (Beijing 2001).

Xie R. J. 1975

Xie Ruiju 谢瑞琚, Gansu Yongji Qinweijia Qijia wenhua mudi 甘肃永靖秦魏家齐家文化墓地 [Qijia culture cemetery at Qinweijia, Yongjing, Gansu]. KGXB 2, 1975, 57-96.

Xie R. J. 1976

Xie Ruiju 谢瑞琚, Qijia wenhua shi Majiayao wenhua de jixu he fazhan 齐家文化是马家窑文化的继续和发展 [Qijia culture is a linear descendent and further development of the Majiayao culture]. KG 6, 1976, 352-355.

Xie R. J. 1979

Xie Ruiju 谢瑞琚, Shilun Qijia wenhua yu Shanxi Longshan wenhua de guanxi 试论齐家文化与陕西龙山文化的关系 [Discussion on the relations between Qijia culture and Longshan culture of Shaanxi]. WW 10, 1979, 60-67.

Xie R. J. 1980a

Xie Ruiju 谢瑞琚, Gansu Yongjing Lianhuatai Xindian wenhua yizhi 甘肃永靖莲花台辛店文化遗址 [Xindian culture site at Lianhuatai in Yongjing county, Gansu]. KG 4, 1980, 296-310.

Xie R. J. 1980b

Xie Ruiju 谢瑞琚, Gansu Yongjing Zhangjiazui yu Jijiachuan yizhi de fajue 甘肃永靖张家咀

与姬家川遗址的发掘 [Excavations at Zhangjiazui and Jijiachuan sites at Yongjing county in Gansu]. KGXB 2, 1980, 187-220.

Xie R. J. 1980c

Xie Ruiju 谢瑞琚, Lun Dahezhuang yu Qinweijia Qijia wenhua de fenqi 论大何庄与秦魏家齐家文化的分期 [Discussion on the periodization of the Qijia culture sites at Dahezhuang and Qinweijia]. KG 3, 1980, 248-254.

Xie/Yang 1960

Xie Qingshan 谢青山/Yang Shaoshun 杨绍舜, Shanxi Lüliangxian Shilou zhen you faxian tongqi 山西吕梁县石楼县又发现铜器 [The bronzes found again from the Shilou town, in Lüliang county, Shanxi Province]. WW 7, 1960, 51-52..

Xigangchaiwangang 2001

Gansusheng wenwu kaogu yanjiusuo 甘肃省文物考古研究所, Yongchang Xigang Chaiwangang-Shajing wenhua muzang fajue baogao 永昌西岗柴湾岗-沙井文化墓葬发掘报告[Xigang and Chaiwangang in Yongchang-Excavation of the Shajing tombs] (Lanzhou 2001).

XN 2000

Xia Nai 夏鼐, Xianai wenji 夏鼐文集 [Collected Work of Xia Nai] (Beijing 2000).

XN 86

Zhongguo kaogu yanjiusuo 中国考古研究所, Zhongguo kaoguxueyanjiu-Xianai xiansheng kaogu wushinian jinianwenji 中国考古学研究-夏鼐先生考古五十年纪念文集 [Collection for memorizing the 50th year of Xia Nai's archaeological work] (Beijing 1986).

XN 87

<Zhongguo kaoguxue yanjiu lunji> bianweihui/<中国考古学研究论集> 编委会 ed., Zhongguo kaoguxue yanjiu lunji-Jinian Xia Nai xiansheng kaogu wushi zhounian 中国考古学研究论集-纪念夏鼐先生考古五十周年 [A collection of the research articles on archaeology in China-In memory of Xia Nai on his fifth anniversary in archeology] (Xi'an 1987).

XRJ 2002

Xie Ruiju 谢瑞琚, Gansu diqu shiqian kaogu 甘肃地区史前考古 [Prehistoric Archaeology in Gansu Region] (Beijing 2002).

Xu T. J. 1988

Xu Tianjin 徐天进, Shanxi Suide Xuejiaqu yizhi de shijue 陕西绥德薛家渠遗址的试掘 [Tentative excavation at Xuejiaqu, Suide, Shaanxi Province]. WW 6, 1988, 28-37.

Xu X. G. et al. 2003

Xu X. G./Wang Wei/M. Wagner/K.-U. Heussner/P. E. Tarasov/B. Griess/Niu S. S./Song J. N./Xiao Y. M./Cai L.H, Results of the first archaeological excavation and environment survey at Fengtai, Qinghai Province, PR China, in 2001. Eurasia Antiqua 9, 2003 (2004), 85-111.

Xu X. S. 1959

Xu Xusheng 徐旭生, Yi jiu wu jiu nian Xia Yuxi diaocha xiaxu de chubu baogao 1959年夏豫西调查夏墟的初步报告 [A primary report on survey of Xia ruins at West Henan in 1959]. KG 11, 1959, 592-600.

Xu Y. J. 1993

Xu Yongjie 许永杰, Hehuang qingtong wenhua de puxi 河湟青铜文化的谱系 [Pedigree of bronze cultures in Hehuang region]. KWL 3, 1993, 166-203.

Xu/Ge 1981

Xu Xinguo 许新国/ Ge Sangben 格桑本, Kayue wenhua Ahatela leixing chutan 卡约文化阿哈特拉类型初探 [Tentative discussion on Ahatela type of Kayue culture]. QHKH 11, 1981, 24-29.

Xu/Ge 1988

Xu Xinguo 许新国/ Ge Sangben 格桑本, Shilun Kayue wenhua de leixing he fenqi 试论卡约文化的类型与分期 [On the type and period of Kayue culture]. QHWW 1, 1988, 35-44.

Xu/Guo 1986

Xu Yongjie 许永杰/Guo Chenhui 郭晨辉, Qinanxian linian chutu de beifangxi qingtongqi 秦安县历年出土的北方系青铜器 [The northern bronzes discovered from Qinan county over the years]. WW 2, 1986, 40-42.

Xu/Li 1993

Xu Cheng 许成/ Li Jinzeng 李进增, Dongzhou shiqi de Rongdi qingtong wenhua 东周时期的戎狄青铜文化 [The Rong and Di bronze cultures in the Eastern Zhou period]. KGXB 1, 1993, 1-11.

Xu/Liu 1985

Xu Junchen 许俊成/Liu Dezhen 刘地祯, Gansu Ningxia Yucun chutu xizhou qingtongqi 甘肃宁县宇村出土西周青铜器 [The bronzes of the Western Zhou period unearthed from Yu village, Ning county, Gansu]. KG 4, 1985, 349-352.

Yan S. Z. 1994

Yan Shizhong 延世忠, Ningxia Guyuan chutu zhanguo qingtongqi 宁夏固原出土战国青铜器 [The Warring States bronze objects unearthed from Guyuan, Ningxia]. WW 9, 1994, 94-96.

Yan W. M 1978

Yan Wenming 严文明, Gansu caitao de qi yuan 甘肃彩陶的起源 [The Origin of the Painted pottery in Gansu]. WW 10, 1978, 62-76.

Yan W. M 1984

Yan Wenming 严文明, Lun zhongguo de tongshi bingyong shidai 论中国的铜石并用时代 [On Chinese Chalcolithic]. SQYJ 1, 1984, 36-44.

Yan W. M. 1987

Yan Wenming 严文明, Zhongguo shiqian wenhua de tongyixing yu duoyangxiang 中国史前文化的统一性与多样性 [The uniformity and multiformity of the pre-historical cultures in China]. WW 2, 1987, 38-50.

Yan/Li 1992

Yan Shizhong 延世忠/Li Huairan 李怀仁, Ningxia Xiji faxian yizuo qingtong shidai muzang 宁夏西吉发现一座青铜时代墓葬 [One Bronze Age grave unearthed from Xiji, Ningxia]. KG 6, 1992, 573-575.

Yang B. C. 1984

- Yang Baocheng 杨宝成, Yin dai chezi de faxian yu fuyuan 殷代车子的发现与复原 [Discovery and recovery of the chariots during the Yin period]. KG 6, 1984, 546-555.
- Yang J. H. 1999
Yang Jianhua 杨建华, Shi lun Xiashang shiqi Yanshan yi nan diqu de wenhua geju 试论夏商时期燕山以南地区的文化格局 [Discussion on the cultural framework in south of the Yanshan during the Xia and Shang period]. BFWW 3, 1999, 1-9.
- Yang J. H. 2000
Yang Jianhua 杨建华, Jibei zhoudai qingtong wenhua chutan 冀北周代青铜文化初探 [Primary discussion on bronze cultures in North Hebei of the Zhou period]. ZYWW 5, 2000, 22-30.
- Yang J. H. 2001
Yang Jianhua 杨建华, Shi lun dongzhou shiqi beifang wenhua dai zhong de Neimenggu diqu 试论东周时期北方文化带中的内蒙古地区 [The Inner Mongolia region in the northern frontier belt during the Eastern Zhou period]. NMGWK 1, 2001. 83-98.
- Yang J. H. 2002
Yang Jianhua 杨建华, Yanshan nan bei Shangzhou zhiji qingtongqi yicun de fenqun yanjiu 燕山南北商周之际青铜器遗存的分群研究 [Research on the groups of the bronzes around south and north of the Yanshan during the Shang and Zhou period]. KGXB 2, 2002, 157-175.
- Yang S. S. 1959
Yang Shaoshun 杨绍舜, Shilou xian faxian gudai tongqi 石楼县发现古代铜器 [Ancient bronzes discovered from the Shilou county]. WW 3, 1959, 71-72.
- Yang S. S. 1975
Yang Shaoshun 杨绍舜, Shanxi Yonghe faxian Yindai qingtongqi 石楼永和发现殷代青铜器 [The Yin bronzes found from Yonghe in Shilou county]. KG 5, 1977, 355-356.
- Yang S. S. 1976
Yang Shaoshun 杨绍舜, Shanxi Shilou xin zhengji dao de jijian Shangdai qingtongqi 山西石楼新征集到的几件商代青铜器 [Some bronzes newly collected from Shilou, Shanxi]. WW 2, 1976, 94.
- Yang S. S. 1981a
Yang Shaoshun 杨绍舜, Shanxi Shilou Zhujiayu, Caojiayuan faxian shangdai tongqi 山西石楼褚家峪, 曹家垣发现商代铜器 [Shang bronzes found from Zhujiayu, Caojiayuan, Shilou, Shanxi]. WW 8, 1981, 49-53.
- Yang S. S. 1981b
Yang Shaoshun 杨绍舜, Shanxi Liulinxian Gaohong faxian Shangdai tongqi 山西柳林县高红发现商代铜器 [Discovery of the Shang bronzes at Gaohong, Liulin county, Shanxi]. KG 3, 1981, 211-212.
- Yang Y. M. 1985
Yang Yimin 杨益民, Gansu Minxian Xinglin Qijia wenhua yizhi diaocha 甘肃岷县杏林齐家文化遗址调查 [Survey of Qijia culture site at Xinglin, Minxian county, Gansu Province]. KG 11, 1985, 977-979.
- Yang Y. M. 1991

Yang Yimin 杨益民, Gansu Minxian faxian sichu Siwa wenhua yizhi 甘肃岷县发现四处寺洼文化遗址 [Four Siwa culture sites found in Min county, Gansu]. KG 1, 1991, 80-81.

Yang/Qi 1999

Yang Ningguo, Qi Yuezhong, Ningxia Pengyangxian jinnian chutu de beifangxi qingtongqi 宁夏彭阳县近年出土的北方系青铜器 [The Northern bronzes found from Pengyang county, Ningxia in recent years]. KG 12, 1999, 28-37.

Yao N. J. 1989

Yao Naijun 姚乃军, Yan'an diqu wenguanhui shoucang de Xiongnu wenwu 延安地区文管会收藏的匈奴文物 [The Xiongnu cultural relics stored in the Managing Committee of Antiquities of Yan'an region]. WB 4, 1989, 72-73.

Yao S. M. 1986

Yao Shengmin 姚生民, Shaanxi Chunhua xian chutu de Shangzhou qingtongqi 陕西淳化县出土的商周青铜器 [Shangzhou Dynasty bronzes discovered in Chunhua, Shaanxi]. KYW 5, 1986, 12-22.

Yao S. M. 1990

Yao Shengmin 姚生民, Shaanxi Chunhua xian xin faxian de Shangzhou qingtongqi 陕西淳化县新发现的商周青铜器 [New discoveries of the Shangzhou bronzes in Chunhua, Shaanxi]. KYW 1, 1990, 53-57.

Yao/Chen 1993

Yao Naijun 姚乃军/Chen Mingde 陈明德, Shaanxi Yanchang chutu yipi xizhou qingtongqi 陕西延长出土一批西周青铜器 [Some bronzes discovered in Yanchang, Shaanxi]. KYW 5, 1993, 8-12.

Yawata Ichiro 1940

Yawata Ichiro, Netkasho hokubu no senshi jidai iseki oyobi ibutsu [Contribution to the prehistoric archaeology of southern Jehol]. In: Report of the First Scientific Expedition to Manchkuo, Section VI, Part III, 1935, 1-114.

Yetts 1925

W. P. Yetts, Chinese Bronze (London 1925).

Yetts 1939

W. P. Yetts, The Cull Chinese Bronzes (London 1939).

Yinxu 94

Zhongguo shehui kexueyuan kaogu yanjiusuo 中国社会科学院考古研究所, Yinxu de faxian yu yanjiu 殷墟的发现与研究 [The discovery and research of Yinxu] (Beijing 1994).

Yinxufuhaomu 80

Zhongguo shehui kexueyuan kaogu yanjiusuo 中国社会科学院考古研究所, Yinyu Fuhao mu 殷墟妇好墓 [Fuhao tomb at Yinxu] (Beijing 1980).

Yinxuqingtongqi 85

Zhongguo shehui kexueyuan kaogu yanjiusuo 中国社会科学院考古研究所 (Ed.), Yinxu Qingtongqi 殷墟青铜器 [Yinxu Bronzes] (Beijing 1985).

YJH 2004

Yang Jianhua 杨建华, Chunqiu zhanguo shiqi zhongguo beifang wenhuadai de xingcheng 春秋战国时期中国北方青铜文化带的形成 [The formation of northern Chinese frontier belt during the Spring and Autumn and Warring States periods] (Beijing 2004).

YKW 1987

Yikezhaomeng wenwu gongzuozhan 伊克昭盟文物工作站, Neimenggu Zhungeerqi Baohaishe faxian qingtongqi 内蒙古准格尔旗宝亥社发现青铜器 [Bronzes found from Baihaishe, Zhungeerqi, Inner Mongolia]. WW 12, 1987, 81-83.

YKW 1991

Yikezhaomeng wenwu gongzuozhan 伊克昭盟文物工作站, Neimenggu Dongsheng shi Nianfangqu faxian jinyinqi jiaocang 内蒙古东胜市碾房渠发现金银器窖藏 [Gold and silver hoard unearthed from Nianfangqu, Dongshen town, Inner Mongolia]. KG 5, 1991, 405-408.

YKW 1992

Yikezhaomeng wenwu gongzuozhan 伊克昭盟文物工作站, Yijinhuoluoqi Shihuigou faxian de Eerduosi shi wenwu 伊金霍洛旗式石灰沟发现的鄂尔多斯式文物 [Ordos remains found from Shihuigou, Yijinhuoluoqi]. NMGWK 1/2, 1992, 91-96.

YKW 1994

Yikezhaomeng wenwu gongzuozhan 伊克昭盟文物工作站, Zhungeerqi Gaojiaping yizhi 准格尔旗高家坪遗址 [The Gaojiaping site in Zhungeerqi]. NMGWKW 1, 1994, 261-271.

YKW et al. 1980

Yikezhaomeng wenwu gongzuozhan 伊克昭盟文物工作站 et al, Xigoupan xiongnu mu 西沟畔匈奴墓 [The Xiongnu tombs at Xigoupan]. WW 7, 1980, 1-11.

YKW et al. 1986

Yikezhaomeng wenwu gongzuozhan 伊克昭盟文物工作站 et al, Xigoupan zhanguomu 西沟畔战国墓 [The Warring States tombs at Xigoupan]. In: Ordos 86, 361-365.

YKW et al. 1992

Yikezhaomeng wenwu gongzuozhan 伊克昭盟文物工作站 et al, Neimenggu Yijinhuoluoqi Xiongnu mu 内蒙古伊金霍洛旗匈奴墓 [The Xiongnu tombs at Yijinhuoluoqi, Inner Mongolia]. WW 5, 1992, 79-81.

Yu J. H. 1996

Yu Jianhua 于建华, Hezui tongfu chulun 鹤嘴铜斧初论 [(On crane-mouth shaped bronze axes)]. BFWW 4, 1996, 22-28.

Yu P. L. 2002

Yu Pingling 于平陵, Qingtongqi chuntong jingli xianxian bianxi 于平陵 青铜器“纯铜晶粒”现象辨析 [Analysis of the pure copper crystal grain in bronzes]. WB 5, 2002, 65-69.

Yu W. C. 1981

Yu Weichao 俞伟超, Guanyu Kayue wenhua de xin renshi 关于卡约文化的新认识 [New understanding about Kayue culture]. QHKK 12, 1981, 11-23.

Yu W. C. 1985a

Yu Weichao 俞伟超, Guanyu Kayue wenhua he Tangwang wenhua de xin renshi 关于卡约文化和唐汪文化的新认识 [New understanding about Kayue culture and Tangwang culture]. In:

YWC 85, 193-210.

Yu W. C. 1985b

Yu Weichao 俞伟超, Gudai Xirong he Qiang Hu kaoguxue wenhua guishu wenti de tantao 古代西戎和羌, 胡登考古学文化归属问题的探讨 [On the culture ascription of ancient Xirong, Qiang and Hu]. In: YWC 85, 180-192.

Yu W. C. 2002

Yu Weichao 俞伟超, Xizhou tongjing de yuanyuan 西周铜镜的渊源 [On the origin of bronze mirrors of Western Zhou]. In: YWC 2002, 340-342.

Yu. Q. 1991

Yu Qiong 喻琼, Cibing shi tongdao chuyi 刺柄式铜刀刍议 [Argument on bronze knives with teathed handle]. BFWW 3, 1991, 12-18.

Yun X. 1984

Yun Xiang 云翔, Siwa wenhua muzang zangshi qianxi 寺洼文化墓葬葬式浅析 [Analysis on the burial manners of the Siwa culture]. SQYJ 4, 1984, 51-54.

YWC 2002

Yu Weichao 俞伟超, Gushi de kaoguxue tansuo 古史的考古学探索 [Archaeological Exploration on Ancient History] (Beijing 2002).

YWC 85

Yu Weichao 俞伟超, Xianqin lianghan kaoguxue lunji 先秦两汉考古学论集 [Papers on Archaeology of Pre-Qin and Two Han Dynasties] (Beijing 1985).

YWJ 98

Shaanxi sheng kaogu yanjiusuo 陕西省考古研究所, Yuanwang ji 远望集 [Collection of Overviews] (Xi'an 1998).

ZFH 95

Zhu Fenghan 朱凤翰, Gudai zhongguo qingtongqi 古代中国青铜器 [Bronzes of Ancient China] (Beijing 1995).

ZH 2001

Zou Heng 邹衡, Xia Shang Zhou kaoguxue lunwenji (di er ban) 夏商周考古学论文集 (第二版) [Collected Work of Xia, Shang and Zhou Archaeology- Second Version] (Beijing 2001).

Zhai D. F. 1988

Zhai Defang 翟德芳, Zhongguo beifang diqu qingtong duanjian fenqun yanjiu 中国北方地区青铜短剑分群研究 [Research on the groups of short bronze swords in northern China]. KGXB 3, 1988, 277-300.

Zhai D. F. 1994

Zhai Defang 翟德芳, Shilun Xiajiadian shangceng wenhua de qingtongqi 试论夏家店上层文化的青铜器 [Tentative discussion on the bronzes of Upper Xiajiadian culture]. NMGWKW 1, 1994, 296-316.

Zhang C. S. 1979

Zhang Changshou 张长寿, Yinshang shidai de qingtong rongqi 殷商时代的青铜容器 [Bronze containers in the Yinshang period]. KGXB 3, 1979, 271-300.

Zhang et al. 1987

Zhang Zhongpei 张忠培/Kong Zhesheng 孔哲生/Zhang Wenjun 张文军/Chen Yong 陈庸, Xiajiadian xiaceng wenhua yanjiu 夏家店下层文化研究 [Research on the Lower Xiajiadian culture]. KWL 1, 1987, 58-78.

Zhang J. 1993

Zhang Jun 张君, Qinghai Lijiasha Kayue wenhua mudu rengu zhongxi yanjiu 青海李家山卡约文化墓地人骨种系研究 [A racio-typological study of the human skulls from the Kayue culture cemetery at Lijiashan, Qinghai]. KGXB 3, 1993, 381-413.

Zhang T. E. 2000

Zhang Tianen 张天恩, Guanzhong xibu Xiandai wenhua yicun de tansuo 关中西部夏代文化遗存的探索 [Exploration on culture remains of Xia Dynasty in the West]. KYW 3, 2000, 44-50.

Zhang X. R. 1994

Zhang Xiurong 张秀荣, Gu Shanrong kaolue 古山戎考略 [Research on ancient Shanrong]. BJWK 4, 1994, 100-115.

Zhang X. Y. 1986

Zhang Xiyong 张锡瑛, Shilun dongbei diqu xianqin tongjing 试论东北地区先秦铜镜 [Tentative discussion on the bronze mirrors of Pre-Qin period in northeast of China]. KG 2, 1986, 163-172.

Zhang X. Z. 1960

Zhang Xuezheng 张学正, Gansu gu wenhua yicun 甘肃古文化遗存 [Ancient remains in Gansu]. KGXB 2, 1960, 11-25.

Zhang X. Z. 1988

Zhang Xuezheng 张学正, Luelun Shanganqing diqu jizhong zhuyao wenhua de yuanliu 略论陕甘青地区几种主要文化的源流 [On the origins of the main cultures in Shaanxi, Gansu and Qinghai region]. XBSD 4, 1988, 38-41.

Zhang X. Z. 1993

Zhang Xuezheng 张学正, Xindian wenhua yanjiu 辛店文化研究 [Research on the Xindian culture]. KWL3, 1993, 122-152.

Zhang Y. 1990

Zhang Ying 张英, Cong kaoguxue kan woguo dongbei gudai minzu huiqi xisu 从考古学看我国东北古代民族“毁器”习俗 [The custom of "destroying wares" in ancient northwestern people from archaeology]. BFWW 3, 1990, 21-27.

Zhang Z. P. 1987a

Zhang Zhongpei 张忠培, Qijia wenhua yanjiu (shang) 齐家文化研究 (上) [Research on Qijia culture (I)]. KGXB1, 1987, 1-18.

Zhang Z. P. 1987b

Zhang Zhongpei 张忠培, Qijia wenhua yanjiu (xia) 齐家文化研究 (下) [Research on Qijia culture (II)]. KGXB 2, 1987, 153-176.

Zhang Z. P. 1990a

Zhang Zhongpei 张忠培, Zhongguo fuxi shizhu zhidu fazhan jieduan de kaoguxue kaocha 中国父系氏族制度发展阶段的考古学考察 [Archaeological observation on developing stage of Chinese patrilineal clan]. In: ZZZP 90, 148-180.

Zhang Z. P. 1990b

Zhang Zhongpei 张忠培, Qijia wenhua yanjiu 齐家文化研究 [Research on Qijia culture]. In: ZZZP 90, 105-147.

Zhang Z. P. 1990c

Zhang Zhongpei 张忠培, Zhongguo zaoqi tongqi de faxian yu yanjiu 中国早期铜器的发现与研究 [On the discovery and research of early Chinese bronzes]. In: ZZZP 90, 231-239.

Zhang Z. P. 1990d

Zhang Zhongpei 张忠培, Zhukaigou yizhi jiqi xiangguan de wenti 朱开沟遗存及其相关的问题 [The remains of the Zhukaigou and related questions]. In: ZZZP 90, 209-213.

Zhang/Liang 1989

Zhang Changshou 张长寿/Liang Xingpeng 梁星彭, Guanyu Xianzhou qingtong wenhua de leixing yu zhou wenhua de yuanyuan 关于先周青铜文化的类型与周文化的渊源 [On the types of the bronze cultures of Pre-Western Zhou and its relation with Western Zhou culture]. KGXB 1, 1989, 1-22.

Zhang/Lü 1988

Zhang Yingwen 张映文/Lü Zhirong 吕志荣, Shaanxi Qingjian xian Lijiaya gu chengzhi fajue jianbao 陕西清涧县李家崖古城遗址发掘简报 [Brief report of the excavation of an ancient city at Lijiaya, Qingjian county, Shaanxi Province]. KYW 1, 1988, 47-48.

Zhang/Qu 1982

Zhang Riqing 张日清/Qu Changzhi 曲长芝, Tongweisu X shexian yingguangfa dui zhenxi wenwu de wu sun fenxi 同位素 X 射线荧光法对珍惜文物的无损分析 [X-ray Fluorescence analysis of rare antiques]. KGXJ 2, 1982, 194-202.

Zhang/Tao 1983

Zhang Xuewu 张学武/Tao Zongye 陶宗冶, Hebei Zhangjiakou shi Nihezi cun chutu yipi qingtongqi 河北张家口市泥河子村出土一批青铜器 [Some bronzes found from Nihezi village, Zhangjiakou, Hebei]. WW 7, 1983, 94.

Zhangjiapo 99

Zhongguo shehui kexueyuan kaogu yanjiusuo 中国社会科学院考古研究所, Zhangjiapo xizhou mudi 张家坡西周墓地 [Western Zhou Cemetery at Zhangjiapo] (Beijing 1999).

Zhao H. C. 1993

Zhao Huacheng 赵化成, Dongzhou Yandai qingtong rongqi de chubu fenxi 东周燕代青铜容器的初步分析 [Primary analysis of Yan State bronze containers in the Eastern Zhou period]. 1993, KYW 2, 60-67.

Zhao J. L. 1992

Zhao Jianlong 赵建龙, Guanyu Yuezhi zu wenhua de qiyan 关于月氏族文化的起源 [On the origin of the Yuezhi culture]. XBSD 1, 1992, 67-74.

Zhao S. C. 1985

Zhao Shengchen 赵生琛, Qinghai Xining faxian Kayue wenhua tongli 青海西宁发现卡约文化铜鬲 [Bronze Li -cooking tripod of Kayue culture discovered in Xining, Qinghai]. KG 7, 1985, 635.

Zhao S. Q. 1986

Zhao Songqiao, Physical geography of China (Beijing China 1986).

Zhao X. 1995

Zhao Xin 赵信, Gansu Wushan Fujiamen shiqian wenhua yizhi fajue jianbao 甘肃武山傅家门史前文化遗址发掘简报 [Brief report of excavation at ancient prehistoric site Fujiamen, Wushan in Gansu Province]. KG 4, 1995, 289-297.304.

Zhao/Li 1956

Zhao Shengchen 赵生琛/Li Hengnian 李恒年, Qinghaisheng wenwu gongzuowu diaocha Lanqing tielu yanxian wenwu 青海省文物工作组调查兰青铁路沿线文物 [Cultural relics along Lanqing railway by Qinghai Provincial Relics Team]. WWCK 11, 1956, 80.

Zhao/Liu 1998

Zhao Fusheng 赵福生/Liu Xu 刘绪, Shi lun Xizhou Yan wenhua yu Zhangjiayuan shangceng wenhua leixing 试论西周燕文化与张家园上层文化类型 [Discussion on the Yan culture and the Upper Zhangjiayuan culture]. BJWB 1, 1998, 32-36.

Zhao/Nan 1988

Zhao Zhijun 赵志君/Nan Yuquan 南玉泉, Shilun Tangwangshi taoqi de wenhua guishu wenti 试论唐汪式陶器的文化归属问题 [On the cultural ascription of Tangwang type pottery]. KYW 1, 1988, 1-6.

Zhao/Si 1993

Zhao Xueye 赵雪野/Si Youwei 司有为, Gansu Bailongjiang liuyu guwenhua yizhi diaocha jianbao 甘肃白龙江流域古文化遗址调查简报 [Report of the survey at ancient sites in Bailongjiang valley, Gansu]. KYW 4, 1993, 8-16.

Zhao/Tian 1976

Zhao Xin 赵信/Tian Jingdong, Beijing Liulihe Xiajiadian xiaceng wenhua muzang 北京琉璃河夏家店下层文化墓葬 [The Lower Xijiadian culture burials in Liulihe, Beijing]. KG 1, 1976, 59-60.

Zhao/Xie 85

Zhao Shengchen 赵生琛/Xie Ruiju 谢瑞琚, Qinghai gudai wenhua 青海古代文化 [Ancient cultures in Qinghai] (Xining 1985).

Zheng G. 1993

Zheng Guang 郑光, Erlitou yizhi yu woguo zaoqi qingtong wenming 二里头遗址与我国早期青铜文明 [On Erlitou site and the earliest Chinese civilization].In: KGS40 93, 190-195.

Zheng G. 1996

Zheng Guang 郑光, Erlitou yizhi de fajue-zhongguo kaoguxue shang de yige lichengbei 二里头遗址的发掘-中国考古学[Excavation at Erlitou-study on origin of China].In: Xiawenhua 96, 703-719.

Zheng L. 1965

Zheng Long 郑隆, Daqingshan xia faxian yipi tongqi 大青山下发现一批铜器 [One group bronzes discovered from Daqingshan]. WW 2, 1965, 50-51.

Zheng S. Z. 1962

Zheng Shaozong 郑绍宗, Youguan Hebei changcheng quyu yuanshi wenhua leixing de taolun 有关河北长城地区原始文化类型的讨论 [On the types of the primary cultures around the Great Wall region in Hebei]. KG 2, 1962, 658-670.

Zheng S. Z. 1977

Zheng Shaozong 郑绍宗, Hebei Pingquan Dongnangou Xiajiadian shang ceng wenhua muzang 河北平泉东南沟夏家店上层文化墓葬 [The Upper Xiajiadian culture tombs at Dongnangou, Pingquan, Hebei]. KG 1, 1977, 51-55.

Zheng S. Z. 1983

Zheng Shaozong 郑绍宗, Luanping xian Hushenha paotaishan shanrong mudi de faxian 滦平县虎什哈炮台山山戎墓地的发现 [The discovery of the Shanrong burials at Paotaishan, Hushenha, Luanping county]. WWZC 7, 1983, 67-74.

Zheng S. Z. 1984

Zheng Shaozong 郑绍宗, Zhongguo beifang qingtong duanjian de fenqi ji xingzhi yanjiu 中国北方青铜短剑的分期及性质研究 [A study of the date and shapes of bronze dagger in northern China]. WW 2, 1984, 37-49.

Zheng S. Z. 1991

Zheng Shaozong 郑绍宗, Lue lun zhongguo beibu changcheng didai faxian de dongwuwen qingtong paishi 略论中国北部长城地带发现的动物纹青铜牌饰 [Discussion on the bronze plaques with animal patterns found from the Great Wall region in northern China]. WWZC 4, 1-32.

Zheng S. Z. 1994

Zheng Shaozong 郑绍宗, Changchen daidai faxian de beifangshi qingtongqi jiqi xiangguan wenti 长城地带发现的北方式青铜刀子及其相关问题 [On the northern bronze knives discovered around the Great Wall and related questions]. WWZC 4, 1994, 28-48.

Zheng/Chen 1985

Zheng zhenxiang 郑振香/ Chen Zhida 陈志达, Yinxu Qingtongqi de fenqi yu niandai 殷墟青铜器的分期与年代 [On the periodization and chronology of Yinxu bronzes]. In: Yinxuqingtongqi 85, 27-78.

Zhengjiangying

Beijing shi wenwu yanjiusuo 北京市文物研究所, Zhengjiaying yu Tazhao-Jumahe liuyu xian qin kaogu wenhua de leixing yu puxi 镇江营与塔照-拒马河流域先秦考古文化的类型与谱系 [Zhengjiaying and Tazhao- classification and pedigree of the Pre-Qin cultures in the Jumahe Valley] (Beijing 1999).

Zhong K. 1964

Zhong Kan 钟侃, Ningxia Taolexian xishi qi shidai yizhi diaocha 宁夏陶乐县新石器遗址调查 [Suvery of one micro-lithic site at Taole county, Ningxia]. KG 5, 1964, 227-231.

Zhong K. 1978

Zhong Kan 钟侃, Ningxia Guyuanxian chutu wenwu 宁夏固原县出土文物 [Remains

unearthed from Guyuan county, Ningxia]. WW 12, 1978, 86-90.

Zhong K. 1987a

Zhong Kan 钟侃, Ningxia Zhongningxian qingtong duanjian mu qingli jianbao 宁夏中宁县青铜短剑墓清理简报 [Excavational report of the burials with short bronze swords in Zhongning county, Ningxia]. KG 9, 1987, 773-777.

Zhong K. 1987b

Zhong Kan 钟侃, Ningxia Guyuan Dianhe Qijia wenhua qingli jianbao 宁夏固原店河齐家文化墓葬清理简报 [Excavation of Qijia culture tombs at Dianhe, Guyuan, Ningxia]. KG 8, 1987, 673-677.

Zhong/Han 1985

Zhong Kan 钟侃/Han Kongle 韩孔乐, Ningxia nanbu chunqiu zhanguo shiqi de qingtong wenhua (Bronze cultures during Spring and Autumn and Warring States period in South Ningxia), ACA 4, culture Relics Publishing House 宁夏南部春秋战国时期的青铜文化 [Spring and Autumn and Warring States bronze cultures in south Ningxia]. Nianhui 8, 1985, 203-231.

Zhong/Zhang 1964

Zhong Kan 钟侃/Zhang Xinzhi 张心智, Ningxia Xijixian Xinglongzhen de Qijia wenhua yizhi 宁夏西吉县兴隆镇的齐家文化遗址 [One Qijia culture site at Xinglong town, Xijie county, Ningxia]. KG 5, 1964, 232-233.

Zhou X. 1990

Zhou Xing 周星, Huanghe shangyou shiqian yicun ji qi zushu tuiding 黄河上游史前遗存及其族属推定 [On prehistoric remains of the upper reaches of the Yellow River and the related ethnic groups]. XBSD 4, 1990, 21-28.

Zhou X. H. 1989

Zhou Xinghua 周兴华, Ningxia Zhongweixian Langwozikeng de qingtong duanjian muqun 宁夏中卫县狼窝子坑的青铜短剑墓群 [The cemetery with short bronze swords at Langwozikeng, Zhongwei county, Ningxia]. KG 11, 1989, 971-980.

ZHSH 2002

Ershiyi shiji zhongguo kaoguxue yu shijie kaoguxue 21 世纪中国考古学与世界考古学 [Chinese Archaeology and World Archaeology in Twenty-first Century] (Beijing 2002).

Zhu G. 1960

Zhu Gui 朱贵, Liaoning Chaoyang Shiertaiyingzi qingtong duanjian mu 辽宁朝阳十二台营子青铜短剑墓 [Bronze dagger tombs at Shiertaiyingzi, Chaoyang county, Liaoning]. KGXB 1, 1960, 63-71.

Zhu H. 1991

Zhu Hong 朱泓, Neimenggu Liangcheng dongzhou shiqi muzang rengu yanjiu 内蒙古凉城东周时期墓葬人骨研究 [Study of the human skeletons from Eastern Zhou tombs at Liangcheng, Inner Mongolia]. KGXJ 7, 1991, 169-191.

Zhu R. X. 2000

Zhu Renxing 朱仁星, Saiwai fengqing hua tongfu 塞外风情话铜鍍 [Bronze Fu-cooking ware in north Great Wall]. GGWWYK 21, 2000, 10.

Zhu Y. G. 1992

Zhu Yonggang 朱永刚, Shilun woguo beifang diqu qiongbingshi zhuji duanjian 试论我国北方地区釜柄式柱脊短剑 [On the short sword with raised ridge and tubular handle in ancient northern China]. WW 12, 1992, 65-72.

Zhu Y. G. 1997

Zhu Yonggang 朱永刚, Da xiao Linghe liuyu han quren duanjian yicun de kaoguxue wenhua ji xiangguan wenti 大小凌河流域含曲刃短剑遗存的考古学文化及相关问题 [Archaeological cultures with remains of the curve-bladed sword around the big and small Linhe valley and related questions]. NMGWKW 2, 1997, 362-374.

Zhu Y. G. 2003

Zhu Yonggang 朱永刚, Zhongguo beifang de guanqiongfú 中国北方的管釜斧 [Tubular axe in northern China]. ZYWW 2, 2003, 30-44.

Zhu Y. G. 2004

Zhu Yonggang 朱永刚, Xiajiadian shangceng wenhua xiang nan de fenbu taishi yu diyu wenhua bianqian 夏家店上层文化向南的分布态势与地域文化变迁 [On the southwards of the Upper Xiajiadian culture and changes of the regional cultures]. In: ZJP70, 2004, 422-436.

Zhukaigou 2000

Neimenggu zizhiqū wēnwù kāogu yánjiānsuǒ 内蒙古文物考古研究所/Eerdosi bowuguan 鄂尔多斯博物馆, Zhukaigou-qingtong shidai zaoqi yizhi fajue baogao 朱开沟-青铜时代早期遗址发掘报告 [Zhukaigou-Excavation report on the early Bronze Age site] (Beijing 2000).

Zirandilidituji 2006

Liu Mingguang 刘明光, Zhongguo ziran dili dituji 中国自然地理地图集 [China's Physical Geography Atlas] (Beijing 2006). 1986.

ZJJK 1982

Zhangjiakou kaogu dui 张家口考古队, Yuxian kaogu jilue 蔚县考古纪略 [Summary of the archaeology in Yu county]. KYW 4, 1982, 10-14.

ZJJK 1984

Zhangjiakou kaogu dui 张家口考古队, Yuxian Xia Shang shiqi kaogu de zhuyao shouhuo 蔚县夏商时期考古的主要收获 [Main archaeological achievements at Yu county in the Xia and Shang period]. KYW 1, 1984.

ZJJK 1988

Zhangjiakou kaogu dui 张家口考古队, Hebei Huailai Guanting shuiku yan'an kaogu diaocha jianbao 河北怀来官厅水库沿岸考古调查简报 [Survey at the Guanting Reservoir in Huailai, Hebei]. KG 8, 1988, 673-681.

ZJKW 1985

Zhangjiakou shi wēnwù shìyè guǎnlisuo 张家口市文物事业管理所, Zhangjiakou shi Baimiao yizhi qingli jianbao 张家口市白庙遗址清理简报 [Excavation at the Baimiao site in Zhangjiakou]. WW 10, 1985, 23-30.

ZK 1972

Zhongguo kexueyuan 中国科学院, Fangshexing tansu ceding niandai baogao 放射性碳素测定年代报告 (一) [Report of the Carbon Radioactive Dating I]. KG 1, 1972, 52-56.

ZKK 1972

Zhongguo kexueyuan kaogu yanjiusuo 中国科学院考古研究所实验室, Fangshexing tansu ceding niandai baogao 放射性碳素测定年代报告 [Report on the radiocarbon dates]. KG 1, 1972, 52-56.

ZKK et al. 1974

Zhongguo kexueyuan kaogu yanjiusuo 中国科学院考古研究所 et al., Beijing fujin faxian de xizhou nuli xunzangmu 北京附近发现的西周奴隶殉葬墓 [Western Zhou tombs buried with slave victims found near Beijing]. KG 5, 1974, 309-322.

ZKKG 1974

Zhongguo kexueyuan kaogu yanjiusuo Gansu gongzuoidui 中国科学院考古研究所甘肃工作队, Gansu Yongjing Dahezhuang yizhi fajue baogao 甘肃永靖大河庄遗址发掘报告 [Excavation at Dahezhuang, Yongjing, Gansu]. KGXB 2, 1974, 29-62.

ZKKL 1961

Zhongguo kexueyuan kaogu yanjiusuo Luoyang fajuedui 中国科学院考古研究所洛阳发掘队, 1959nian Henan Yanshi Erlitou yizhi fajue jianbao 1959年河南偃师二里头遗址发掘简报 [A brief report at Erlitou, Yanshi, Henan in 1959]. KG 11, 1961, 82-85.

ZKKN 1961

Zhongguo kexueyuan kaogu yanjiusuo neimenggu fajuedui 中国科学院考古研究所内蒙古发掘队, Neimenggu Chifeng Yaowangmiao, Xiajiadian yizhi shijue jianbao 内蒙古赤峰药王庙夏家店遗址试掘简报 [Experimental excavation report at at Yaowangmiao and Xiajiadian, Chifeng, Inner Mongolia]. KG 2, 1961, 77-80.

ZKKN 1974

Zhongguo kexueyuan kaogu yanjiusuo Neimenggu gongzuoidui 中国科学院考古研究所内蒙古工作队, Chifeng Yaowangmiao, Xiajiadian yizhi shijue baogao 赤峰药王庙, 夏家店遗址试掘报告 [Trial diggings at Yaowangmiao and Xiajiadian in Chifeng]. KGXB 1, 1974, 111-144.

ZKKN 1975

Zhongguo kexueyuan kaogu yanjiusuo Neimenggu gongzuodui 中国科学院考古研究所内蒙古工作队, Ningcheng Nanshengen yizhi fajue baogao 宁城南山根遗址发掘报告 [Trial diggings at Nanshengen in Ningcheng]. KGXB 1, 1975, 117-140.

ZKXLC40

Zhongguo shehui kexueyuan kaogusuo 中国社会科学院考古所 (Ed.), Zhongguo kaoguxue luncong-shekeyuan kaogusuo sishi zhounian jinian wenji 中国考古学论丛-社科院考古所建所 40周年纪念文集 [Treatises on Chinese Archaeology-to the 40th Anniversary of the Founding of the Institute of Archaeology, CASS] (Beijing 1995).

ZLB 2005

Zhuanglangxian bowuguan 庄浪县博物馆, Zhuanglangxian Shaopingcun chutu yipi qingtongqi 庄浪县邵坪村出土一批青铜器 [One group bronzes found from Shaoping village, Zhuanglang county]. WW 3, 2005, 43-46.

Zou H. 1999

Zou Heng 邹衡, Guanyu Xia wenhua de shangxian wenti 关于夏文化的上限问题 [On the

earliest Xia culture] (KYW 5, 1999, 51-55).

Zou H. 2001a

Zou Heng 邹衡, Lun XianZhou wenhua 论先周文化 [Discussion on pre-Zhou cultures]. In: ZH 2001, 273-327.

Zou H. 2001b

Zou Heng 邹衡, Shilun Xia wenhua 试论夏文化 [Discussion on Xia culture]. In: ZH 2001, 89-170.

Zou H. 2001c

Zou Heng 邹衡, Shilun Yinxu wenhua fenqi 试论殷墟文化分期 [On the stages of Yinxu culture]. In: ZH 2001, 29-86.

Zou H. 2001d

Zou Heng 邹衡, Guanyu Xiashang shiqi beifang diqu zhu linjing wenhua de chubu tantao 关于夏商时期北方地区诸邻境文化的初步探讨 [Tentative discussion on the neighboring cultures in northern China during the Xia and Shang period]. In: ZH 2001, 233-270.

ZSKK 2003

Zhongguo shehui kexueyuan kaogu yanjiusuo 中国社会科学院考古研究所, Zhongguo kaoguxue XiaShang juan 中国考古学夏商卷 [Chinese Archaeology · Xia and Shang] (Beijing 2003).

ZSKKA 1983

Zhongguo shehui kexueyuan kaogu yanjiusuo Anyang gongzuodui 中国社会科学院考古研究所安阳工作队, Anyang Yinxu Sanjiazhuang dong de fajue 安阳殷墟三家庄东的发掘 [Excavation at east of Sanjiazhuang, Yinxu, Anyang]. KG 2, 1983, 126-32.

ZSKKD 1981

Zhongguo shehui kexueyuan kaogu yanjiusuo Dongbei gongzuidui 中国社会科学院考古研究所东北工作队, Neimenggu Ningchengxian Nanshangen 102 hao shiguomu 内蒙古宁城县南山根 102 号石椁墓 [No.102 stone-chambered tomb at Nanshangen, Ningcheng city, Inner Mongolia]. KG 4, 1981, 304-308.

ZSKKE 1983

Zhongguo shehui kexueyuan kaogu yanjiusuo Erlitou gongzuidui 中国社会科学院考古研究所二里头工作队, 1980nian qiu Henan Yanshi Erlitou yizhi fajue jianbao 1980 年秋河南偃师二里头遗址发掘简报 [Excavation at the Erlitou site, Yanshi, Hennan in autumn of 1980]. KG 3, 1983, 199-205.

ZSKKE 1985

Zhongguo shehui kexueyuan kaogu yanjiusuo Erlitou gongzuidui 中国社会科学院考古研究所二里头工作队, 1982nian qiu Yanshi Erlitou yizhi jiuqu fajue jianbao 1982 年秋偃师二里头遗址九区发掘简报 [Report of the excavation at the ninth district of Erlitou site, Yanshi in autumn of 1982]. KG 12, 1985, 1085-1094.

ZSKKG 1983

Zhongguo shehui kexueyuan kaogu yanjiusuo Gansugongzuidui 中国社会科学院考古研究所甘肃工作队, Gansu Tianshui diqu kaogu diaocha jiyao 甘肃天水地区考古调查纪要 [Archaeological survey in Tianshui region, Gansu]. KG 12, 1983, 1066-1075.

ZSKKJ 1981

Zhongguo shehui kexueyuan kaogu yanjiusuo Jingwei gongzuidui 中国社会科学院考古研究所泾渭工作队, Longdongzhen Yuanchangshan yizhi fajue jianbao 陇东镇原常山遗址发掘简报 [Excavation at Yuanchangshan, Longdong]. KG 4, 1981, 201-210.

ZSKKJ 1982

Zhongguo shehui kexueyuan kaogu yanjiusuo Jingwei gongzuidui 中国社会科学院考古研究所泾渭工作队, Gansu Zhuanglangxian Xujianian Siwa wenhua muzang fajue ji 甘肃庄浪县徐家碾寺洼文化墓葬发掘记 [Excavation of the Siwa culture burials at Xujianian, Zhuanglang, Gansu]. KG 6, 1981, 584-590.

ZSKKJ 1989

Zhongguo shehui kexueyuan kaogu yanjiusuo Jingwei gongzuidui 中国社会科学院考古研究所泾渭工作队, Shaanxi Changwu Nianzipo xianzhou wenhua yizhi fajue jilue 陕西长武碾子坡先周文化遗址发掘纪略 [Excavation of Pre-Zhou culture site at Nianzipo, Changwu, Shaanxi]. KGXJ 6, 1989, 123-141.

ZSKKN 1979

Zhongguo shehui kexueyuan kaogu yanjiusuo Neimengu gongzuidui 中国社会科学院考古研究所内蒙古工作队, Chifeng Zhizhushan yizhi de fajue 赤峰蜘蛛山遗址的发掘 [Excavations at Zhizhushan, Chifeng]. KGXB 2, 1979, 215-243.

ZSKKN 1984

Zhongguo shehui kexueyuan kaogu yanjiusuo Neimengu gongzuidui 中国社会科学院考古研究所内蒙古工作队, Neimenggu Aohanqi Zhoujiadi mudi fajue jianbao 内蒙古敖汉旗周家地墓地发掘简报 [Brief report of the excavation at Zhoujiadi cemetery in Aohan Banner, Inner Mongolia]. KG 5, 1984, 417-426.

ZSKKGQ 1995

Zhongguo shehui kexueyuan kaogu yanjiusuo Ganqing gongzuidui 中国社会科学院考古研究所甘青工作队, Gansu Wushan Fujiamen shiqian wenhua yizhi fajue jianbao 甘肃武山傅家史前文化遗址发掘简报 [Brief report of the excavation of pehistorical site at Fujiamen, Wushan, Gansu]. KG 4, 1995, 249-296.

ZSKKGQ 2002

Zhongguo shehui kexueyuan kaogu yanjiusuo Ganqing gongzuidui 中国社会科学院考古研究所甘青工作队, Qinghai Minhexian Lajia yizhi 2000 nian fajue jianbao 青海民和县喇家遗址 2000 年发掘简报 [Brief report of the excavation at Lajia in Minhe county, Qinghai in 2000]. KG 12, 2002, 25-28.

ZSKKS 1978

Zhongguo shehui kexueyuan kaogu yanjiusuo shiyanshi 中国社会科学院考古研究所实验室, Fangshe xing tansu ceding niandai baogao (wu) 放射性碳素测定年代报告 (五) [Radiocarbon dating measurement (V)]. KG 4, 1978, 280-286.

ZSKKS 1981

Zhongguo shehui kexueyuan kaogu yanjiusuo shiyanshi 中国社会科学院考古研究所实验室, Fangshe xing tansu ceding niandai baogao (ba) 放射性碳素测定年代报告 (八) [Radiocarbon dating measurement (VIII)]. KG 6, 1981, 363-369.

ZSKKS 1982

Zhongguo shehui kexueyuan kaogu yanjiusuo shiyanshi 中国社会科学院考古研究所实验室, Fangshe xing tansu ceding niandai baogao (jiu) 放射性碳素测定年代报告 (九) [Radiocarbon dating measurement (IX)]. KG 6, 1982, 657-662.

ZSKKS 1986

Zhongguo shehui kexueyuan kaogu yanjiusuo shiyanshi 中国社会科学院考古研究所实验室, Fangshe xing tansu ceding niandai baogao (shi san) 放射性碳素测定年代报告 (十三) [Radiocarbon dating measurement (XIII)]. KG 7, 1986, 656-659.

ZSKKS 1989

Zhongguo shehui kexueyuan kaogu yanjiusuo shiyanshi 中国社会科学院考古研究所实验室, Fangshe xing tansu ceding niandai baogao (shi liu) 放射性碳素测定年代报告 (十六) [Radiocarbon dating measurement (XVI)]. KG 7, 1989, 657-660.

ZSKKS 1990

Zhongguo shehui kexueyuan kaogu yanjiusuo shiyanshi 中国社会科学院考古研究所实验室, Fangshe xing tansu ceding niandai baogao (shi qi) 放射性碳素测定年代报告 (十七) [Radiocarbon dating measurement (XVII)]. KG 7, 1990, 667-668.

ZSKKS 1991

Zhongguo shehui kexueyuan kaogu yanjiusuo shiyanshi 中国社会科学院考古研究所实验室, Fangshe xing tansu ceding niandai baogao (shi ba) 放射性碳素测定年代报告 (十八) [Radiocarbon dating measurement (xviii)]. KG 7, 1991, 657-662.

ZSKKSH 1984

Zhongguo shehui kexueyuan kaogu yanjiusuo Shanxi gongzuidui 中国社会科学院考古研究所山西工作队, Shanxi Xiangfen Taosi yizhi shouci faxian tongqi 山西襄汾陶寺遗址首次发现铜器 [First discovery of the bronzes from Taosi, Xiangfen, Shanxi]. KG 12, 1984, 1069-1071.

ZSKKX et al. 1990

Zhongguo shehui kexueyuan kaogu yanjiusuo Xinjiangdui 中国社会科学院考古研究所新疆队, Xinjiang Hejing Chawuhu goukou sanhao mudi fajue jianbao 新疆和静察吾乎沟口三号墓地发掘简报 [Brief report on excavation at third cemetery of Goukou, Chawuhu, Hejing, Xinjiang]. KG 10, 1990, 882-889.

ZSKKX et al. 1991

Zhongguo shehui kexueyuan kaogu yanjiusuo Xinjiangdui 中国社会科学院考古研究所新疆队, Luntaixian Qunbake muzang di er san ci fajue jianbao 新疆轮台县群巴克墓葬第二三次发掘简报 [Brief report on the second and third excavation at Qunbake cemetery, Luntai county, Xinjiang]. KG 8, 1991, 684-703.

ZT 99

Beijing shi wenwu yanjiusuo 北京市文物研究所 ed., Zhengjiangying yu Tazhao 镇江营与塔照 [The Zhengjiangying and Tazhao site] (Beijing 1999).

ZWL 2003

Zhang Wenli 张文立, Qinghai diqu qingtong shidai wenhua yanjiu 青海地区青铜时代文化研究 [Research on the cultures of the Bronze Age of Qinghai region] (Changchun 2003).
Doctoral dissertation.

ZZP 90

Zhang Zhongpei 张忠培, Zhongguo beifang kaogu wenji 中国北方考古文集 [Papers on northern China] (Beijing 1990).

ZZP70

Ji da bianjiang kaogu yanjiu zhongxin 吉大边疆考古研究中心 ed., Qingzhu Zhangzhongpei xiansheng qishisui lunwen ji 庆祝张忠培先生七十岁论文集 [Papers on celebrating the 70th birthday of Mr. Zhang Zhongpei] (Changchun 2004).