

Abb. 142: Sachsenheim-Großsachsenheim, LB, ‚Holderbüschle‘ (215): 1 Grubenhaus 1; 2 Grubenhaus 2. M. 1:50.



Abb. 143: Sachsenheim-Großsachsenheim, LB, ‚Holderbüschle‘ (215). Grubenhaus 1. Profile. M. 1:40.



Abb. 144: Sachsenheim-Großsachsenheim, LB, ‚Holderbüschle‘ (215). Grubenhaus 2. Profile. M. 1:40.

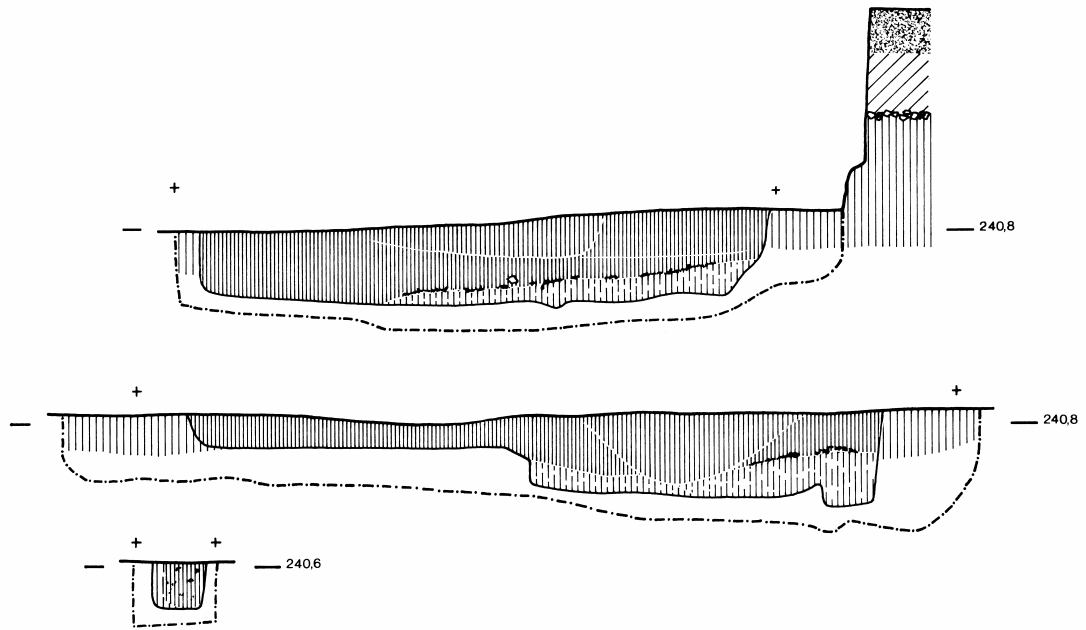

Abb. 145: Sachsenheim-Großsachsenheim, LB, ‚Holderbüschle‘ (215). Grubenhaus 2. M. 1:3.

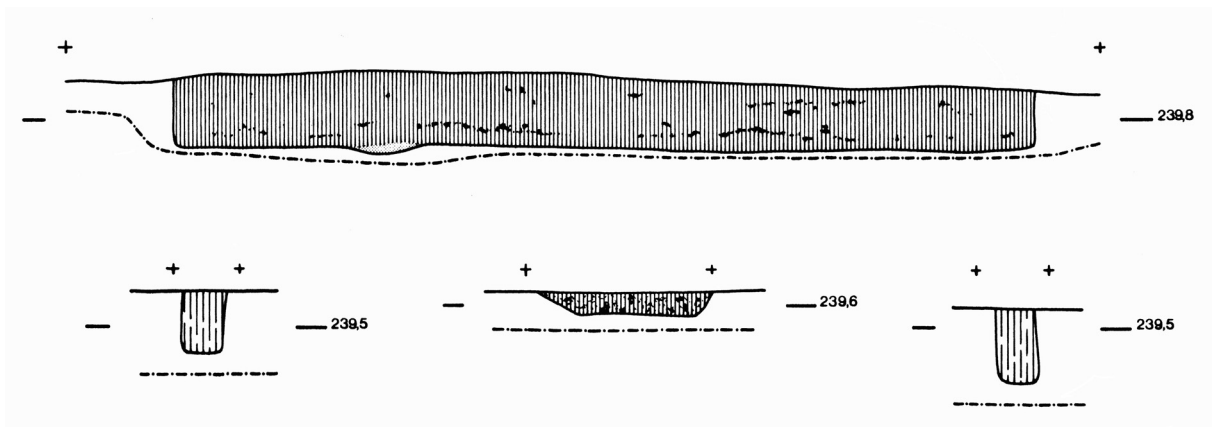

Abb. 146: Remseck-Neckarrems, LB, ‚Neckarhalde‘ (212). M. 2:3.

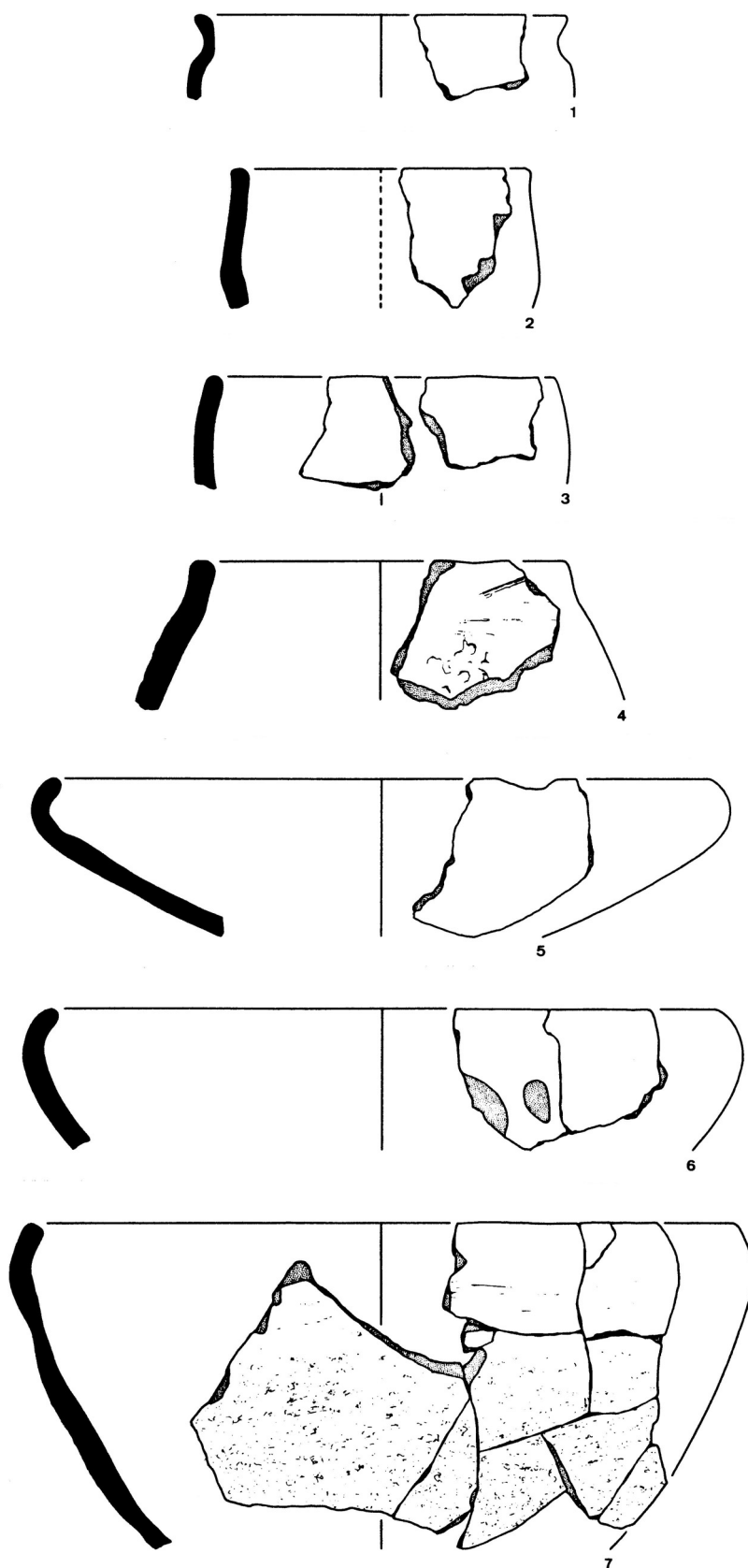

Abb. 147: Walheim, LN, Lerchenweg (230f). M. 2:3.

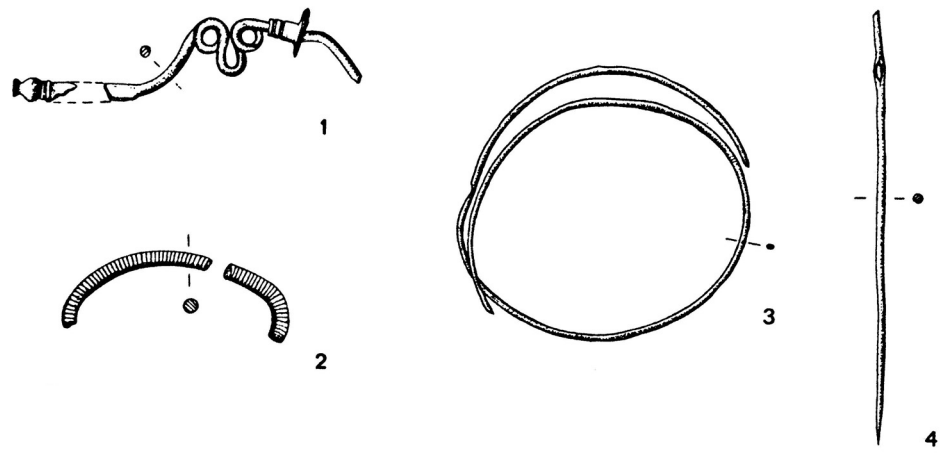

Abb. 148: Fellbach-Öffingen, WN, Weidachstrasse (234b). M. 1:2.

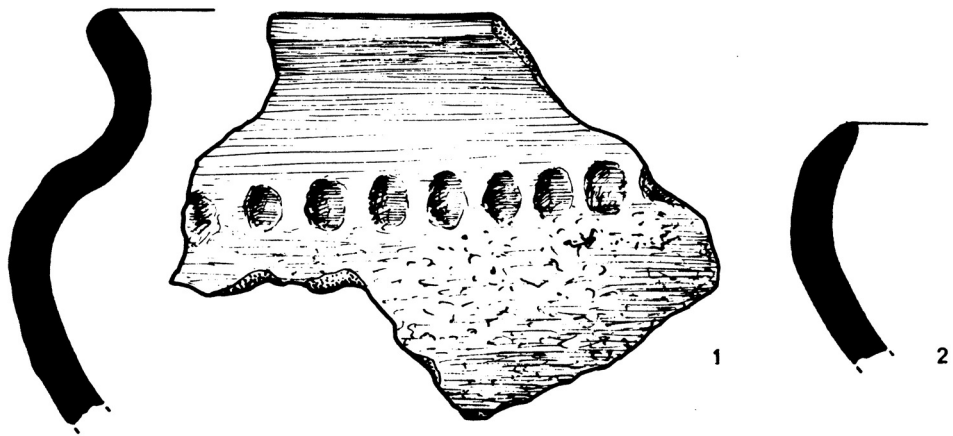

Abb. 149: Fellbach-Schmiden, WN, ‚Gassenäcker‘ (237b). M. 1:3.

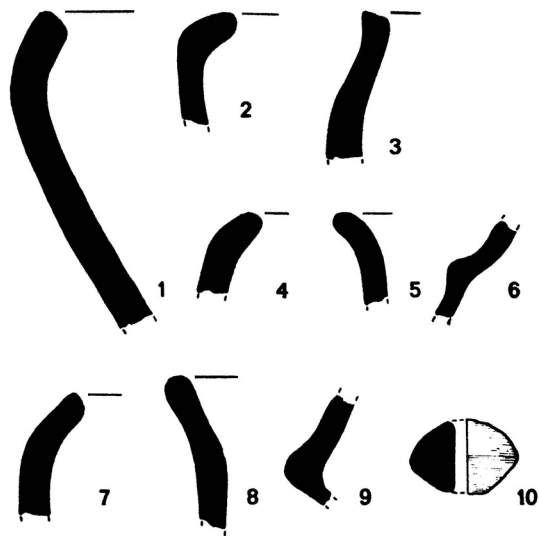

Abb. 150: Fellbach-Schmiden, WN, ‚Stiefeläcker‘ (238). 1-4.6 Bronze; 5 Knochen. M. 2:3.

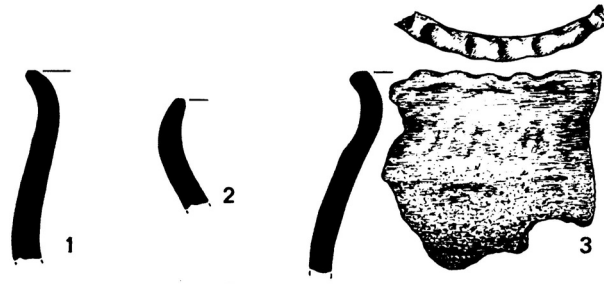

Abb. 151: Schwaikheim, WN, ‚Och‘ (241). M. 1:2

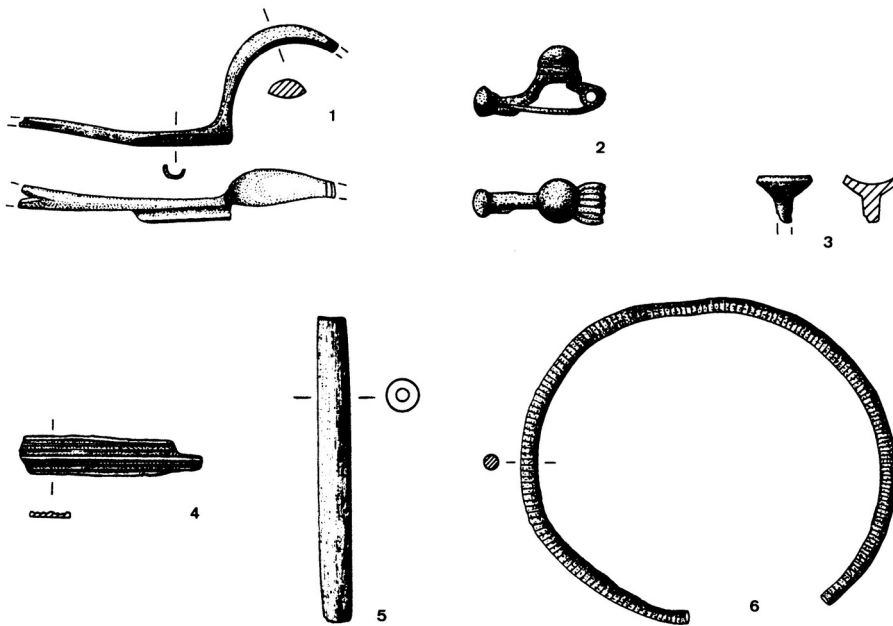

Abb. 152: Weinstadt-Endersbach, WN, ‚Rosenäcker‘ (245a). Grubenhaus (?) Grundriß- und Profilskizzen. M. 1:40.

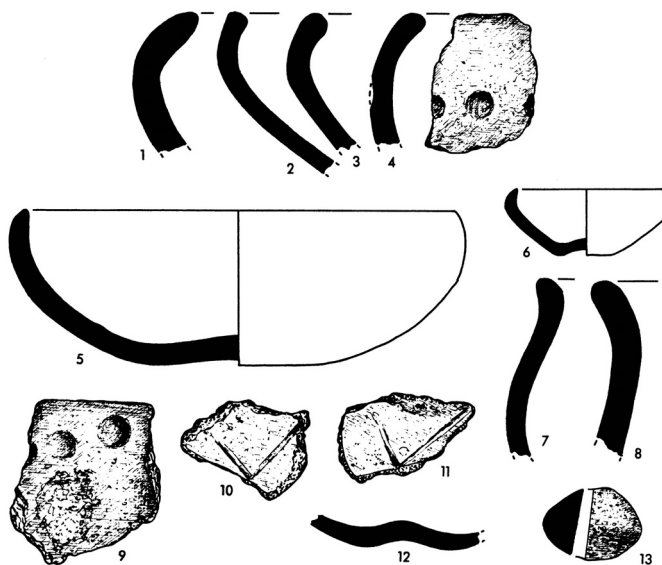

Abb. 153: Brackenheim-Meimsheim, HN, ‚Langer Lenz‘ (325a). M. 1:3.

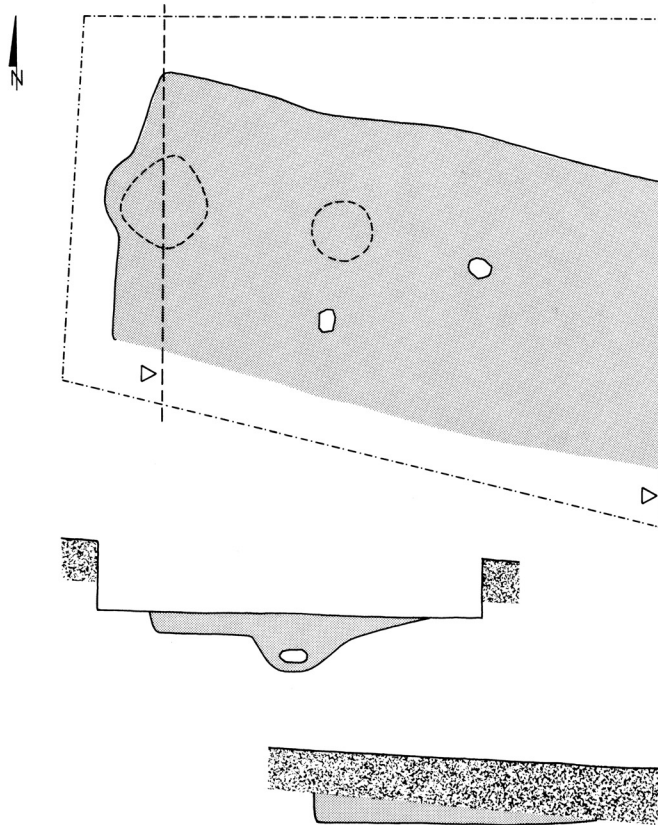

Abb. 154: Lauffen/Neckar, HN, ‚Kaltenberg‘ (355b) M. 1:3.

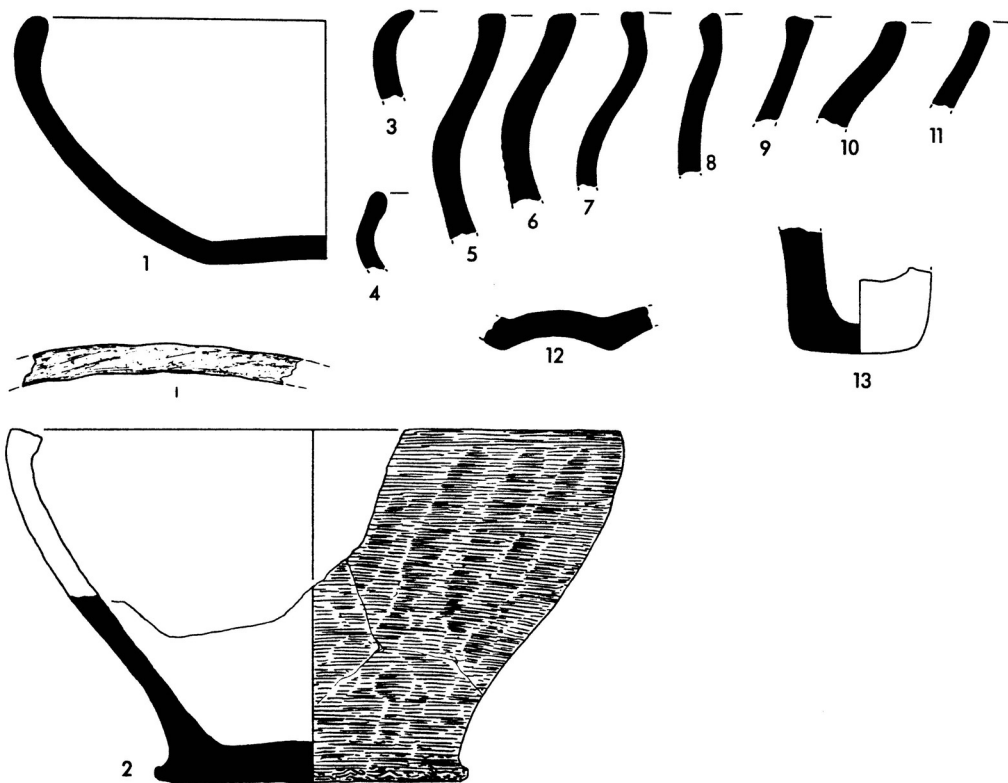

Abb. 155: Lauffen/Neckar, HN, ‚Hinteres Pfaffental (363b). Muschelschale und Knochen. M. 2:3.

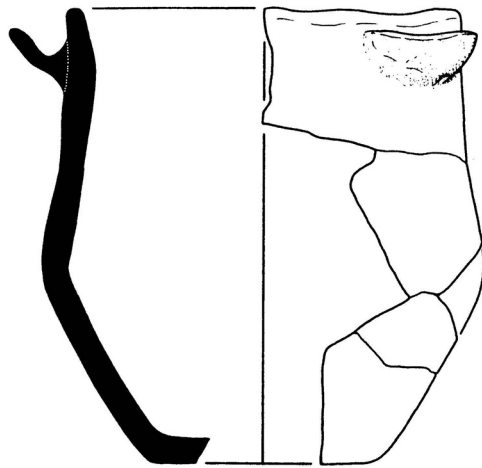

Abb. 156: Lauffen/Neckar, HN, ‚Köberer‘ (368a). M. 1:3.

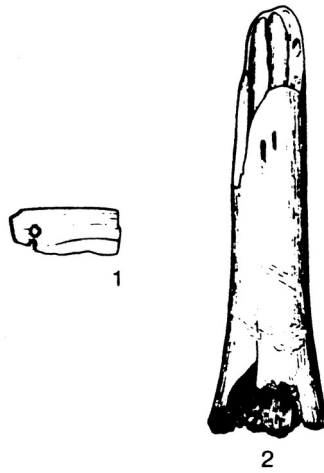

Abb. 157: Leingarten-Großgartach, HN, wohl ‚Annungsgrund‘ (381a). ohne Maßstab.

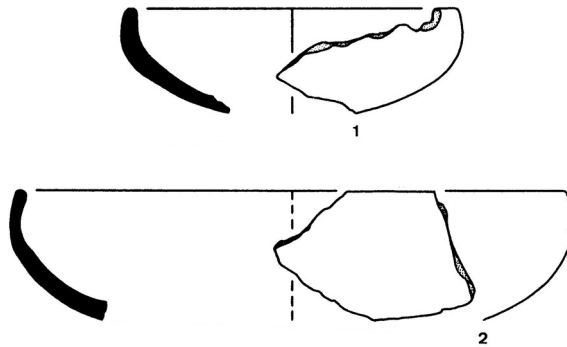

Abb. 158: Leingarten-Großgartach, HN, ‚Strohäcker‘ (397). Siedlungsgrube mit Bestattung.

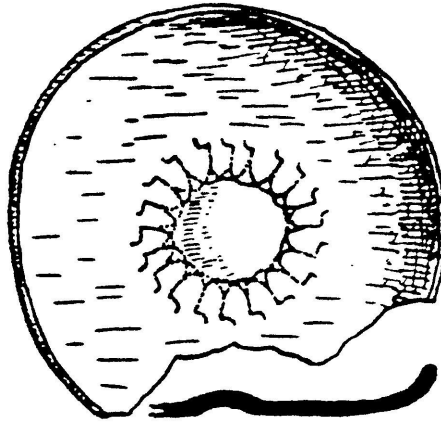

Abb. 159: Leingarten-Großgartach, HN, ‚Steingemerr‘ (399a). M. 1:3.

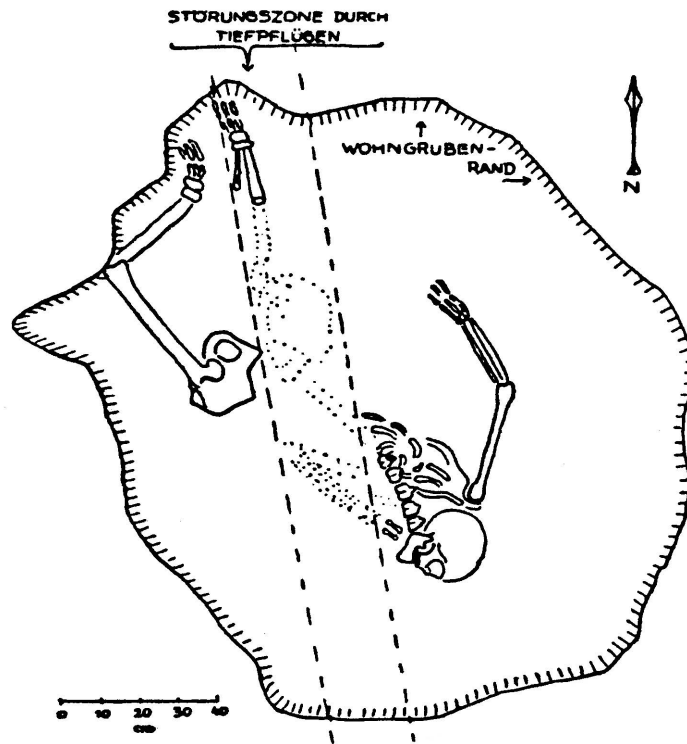

Abb. 160: Möckmühl, HN, Stadtkirche (408). M. 1:2.

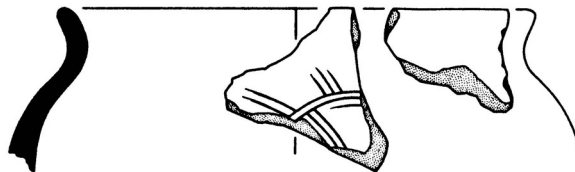

Abb. 161: Neckarsulm, HN, 'Untere Wildäcker' (410a). Bronze. M. 1:2.

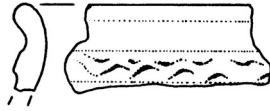

Abb. 162: Neckarsulm-Obereisesheim, HN, 'Bei dem Brechhaus' (415). M. 1:2.

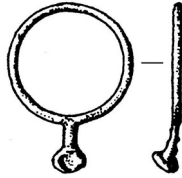

Abb. 163. Dörzbach, KÜN, 'Marderhöhle' (470). M. ca. 1:1.

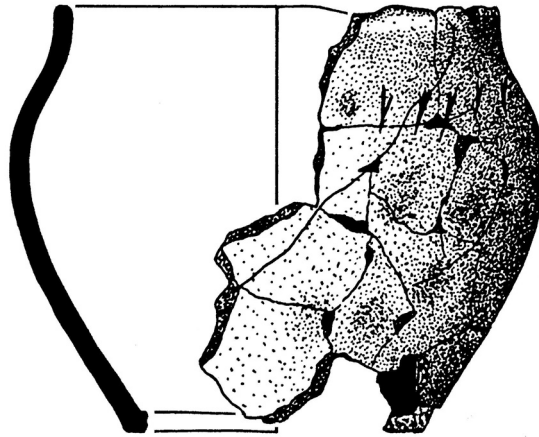

Abb. 164: Rot am See-Hausen am Bach, SHA, ‚Hueb‘. M. 1:3.



Abb. 165: Bad Mergentheim-Neunkirchen, TBB, ‚Wolfental‘ (510a). M. 1:3.

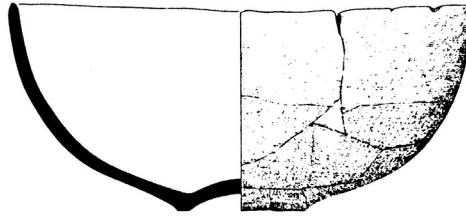

Abb. 166: Lauda-Königshofen, Gerlachsheim, TBB, ‚Hühnerberg‘ (518). M. 1:2.

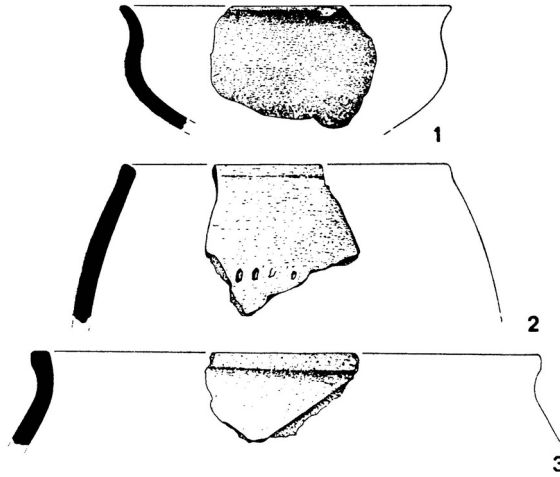

Abb. 167: Niederstetten, TBB, Stadtkirche (520). M. 1:2.

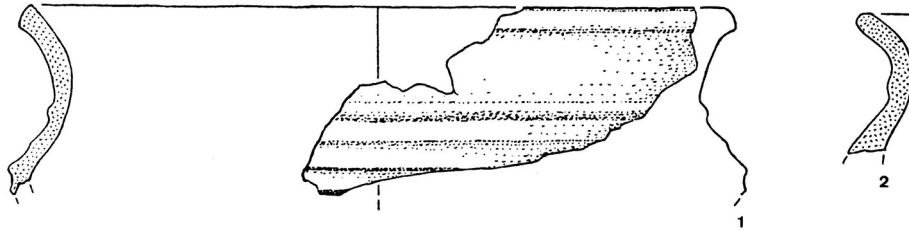

Abb. 168: Tauberbischofsheim, TBB, ‚Krautgartenäcker‘ (521a). 1.3 M. 1:4; 2 M. 1:8.

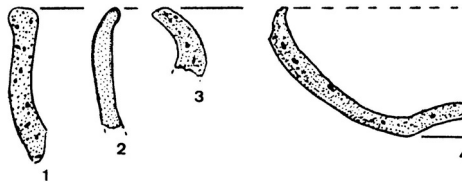

Abb. 169: Tauberbischofsheim, TBB, ‚Fronbrunnen‘ (523) Fundstelle 1. M. 1:3.

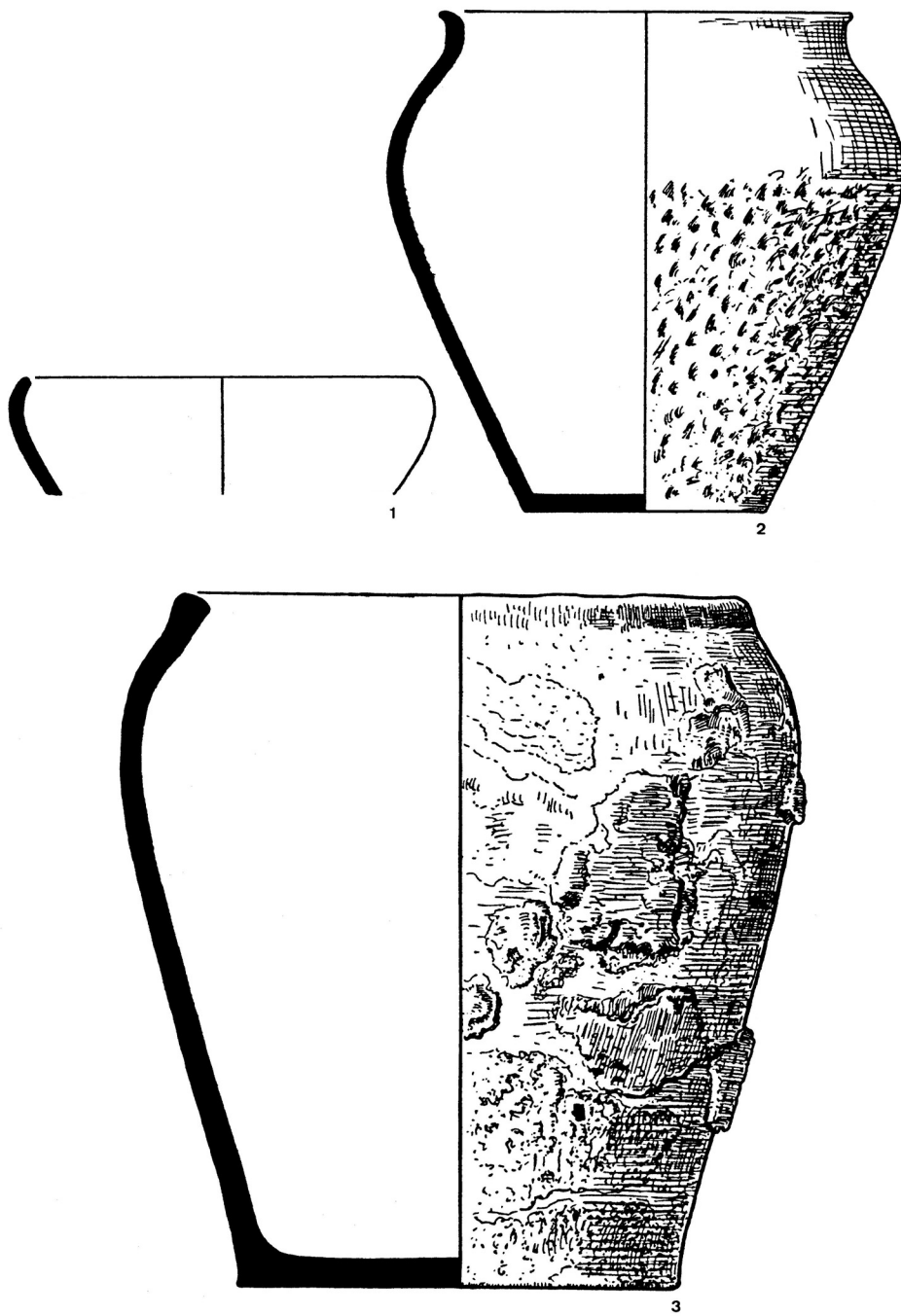

Abb. 170: Tauberbischofsheim-Impfingen, TBB, ‚Rüdig‘ (525) Fundstelle 2. M. 1:3.

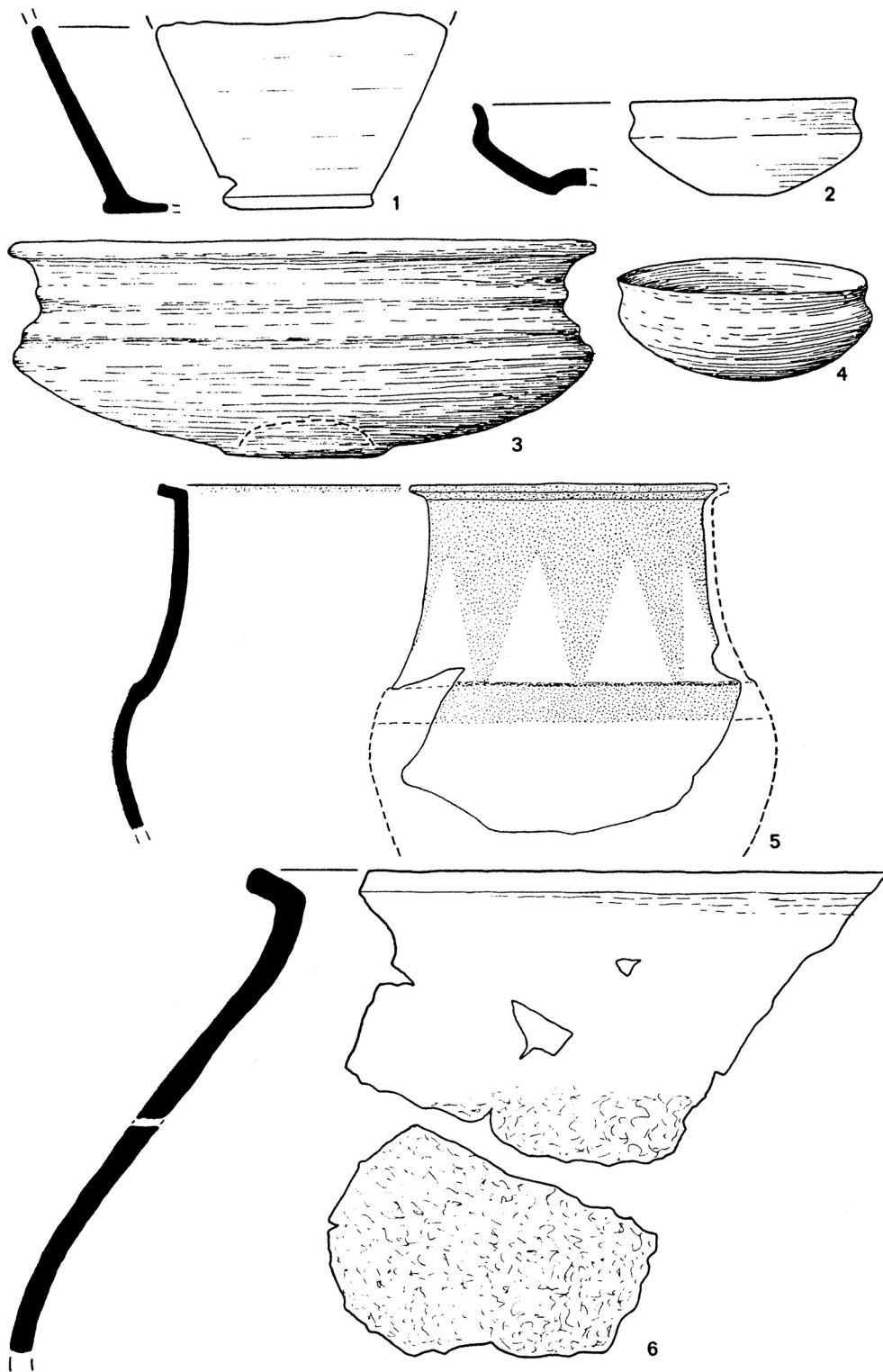

Abb. 171: Tauberbischofsheim-Impfingen, TBB, 'Rüdiger' Fundstelle 5. M. 1:3.

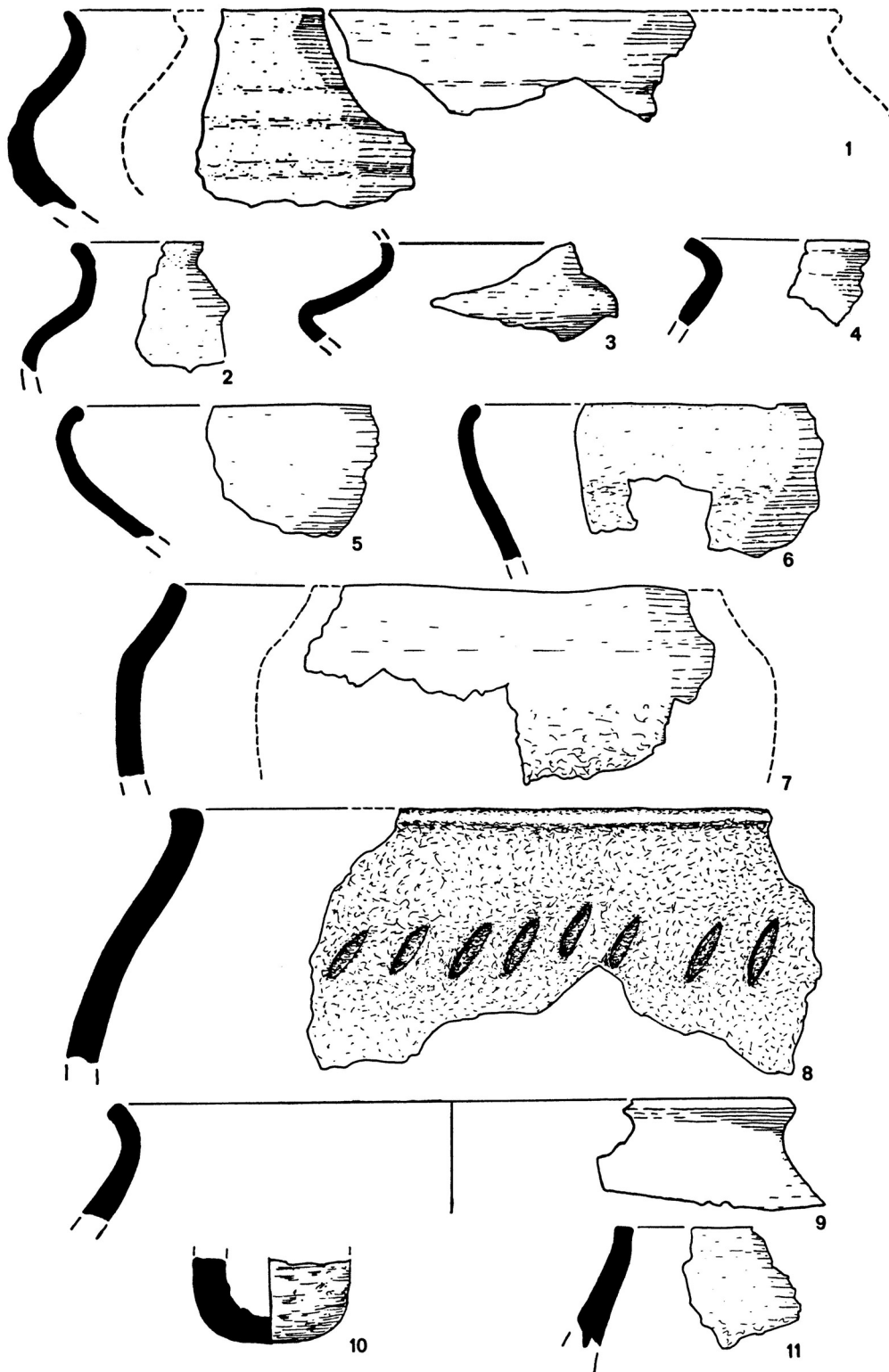

Abb. 172: Tierknochen mit durchbohrtem Schaft: 1 Weikersheim, TBB, Marktplatz (526);
 2 Bopfingen, AA, „lpf“ (545c).
 1 M. 2:3; 2 M. 1:2.

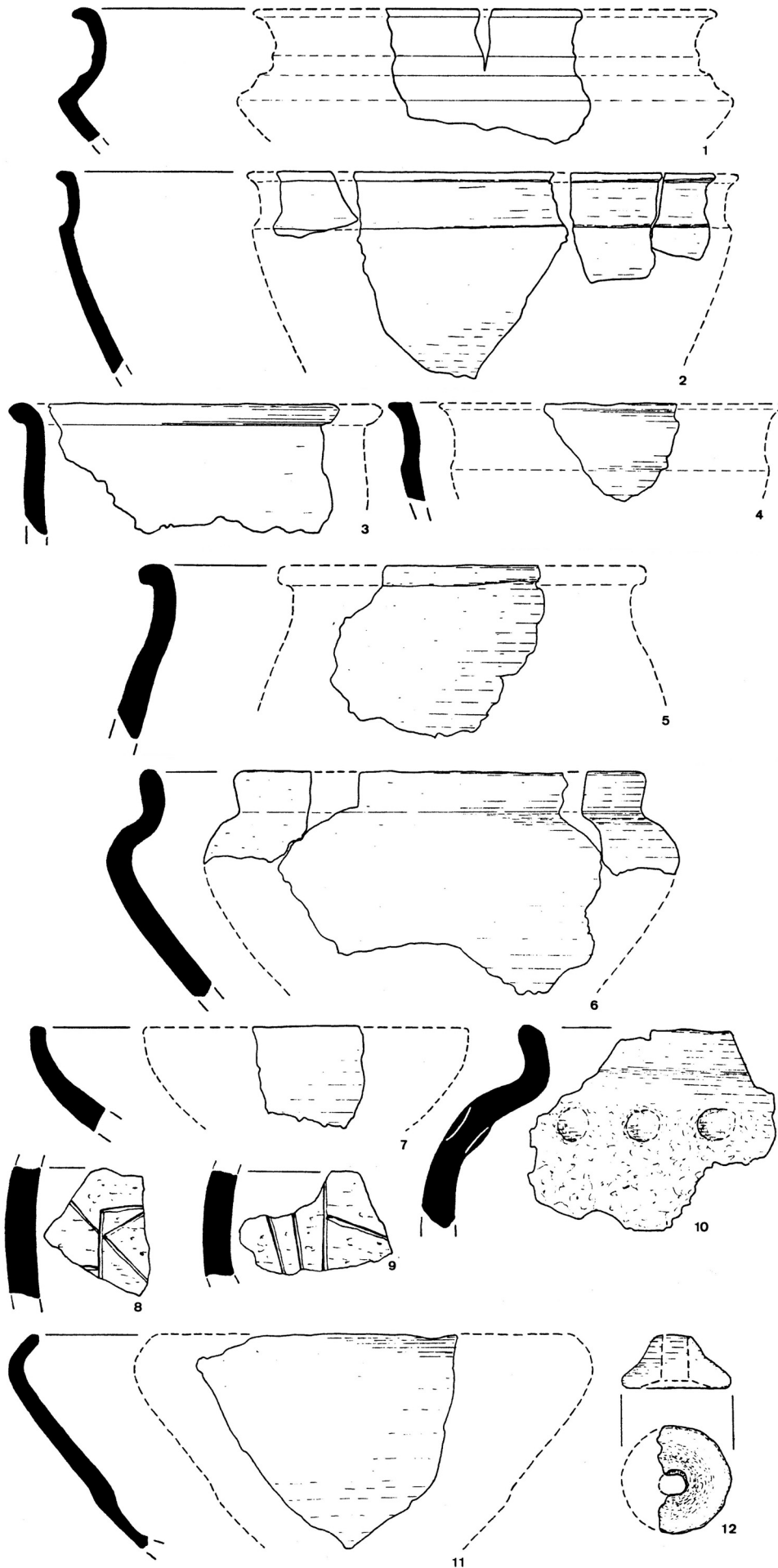

Abb. 173: Riesbürg-Goldburghausen, AA, „Goldberg“ (551). 1-9.11-14 Bronze; 10 Eisen; 15 Knochen.
 1-14 etwa M. 2:3; 15 M. 2:3.

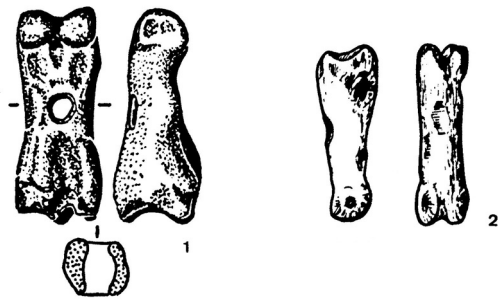

Abb. 174: Hayingen-Indelhausen, RT, ‚Alt-Hayingen‘ (556). 3 Eisen; 9 Bronze mit Bernstein; 18 Sapolit; sonst Bronze. M. 1:1.

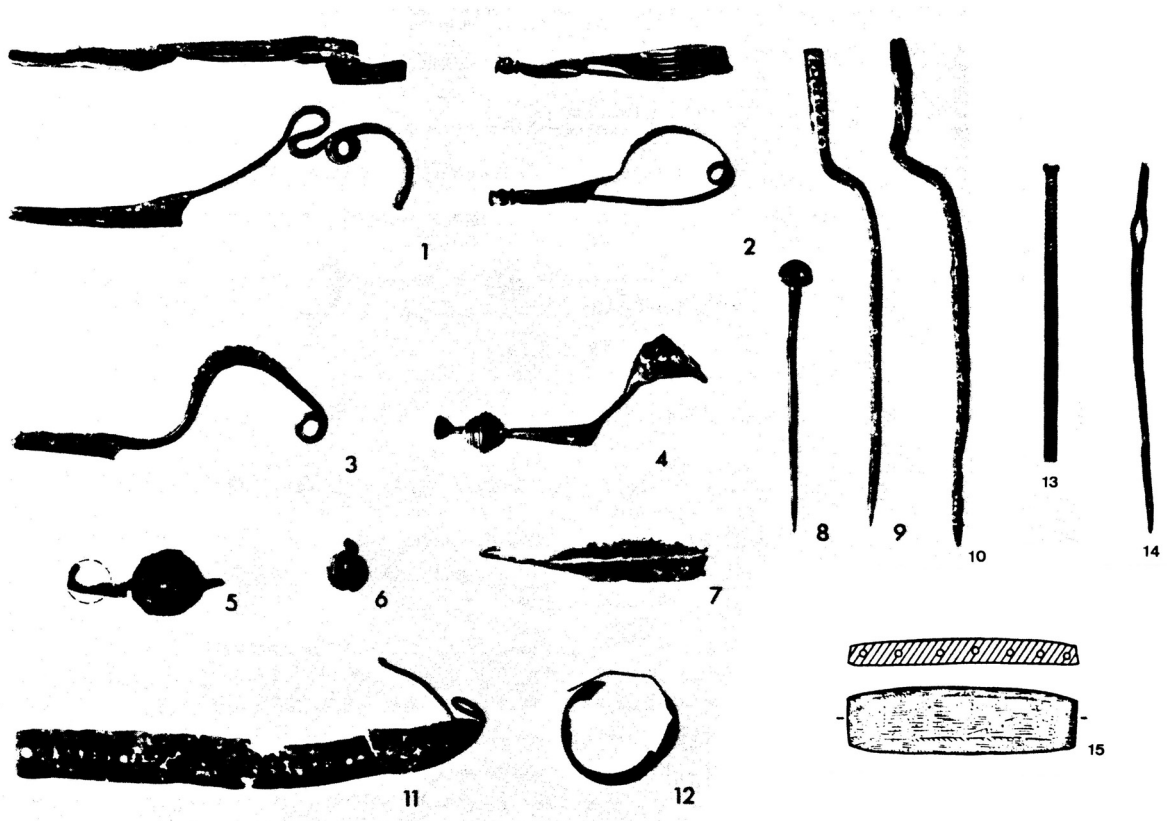

Abb. 175: Hayingen-Indelhausen, RT, ‚Alt-Hayingen‘ (556). etwa M. 1:3.

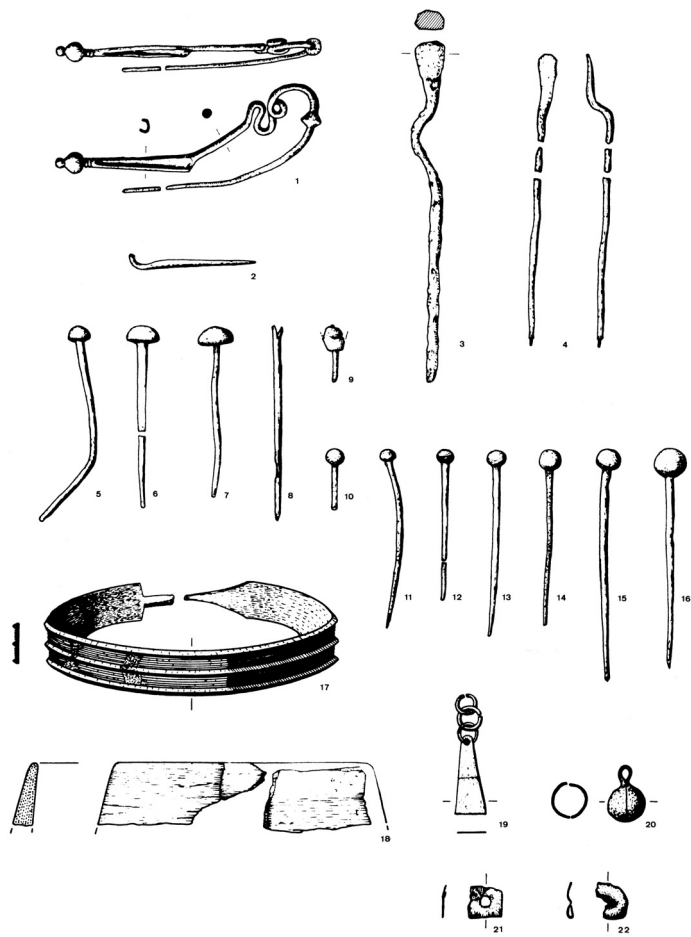

Abb. 176: Hayingen-Indelhausen, RT, ‚Gerberhöhle‘ (557). M. 1:2.

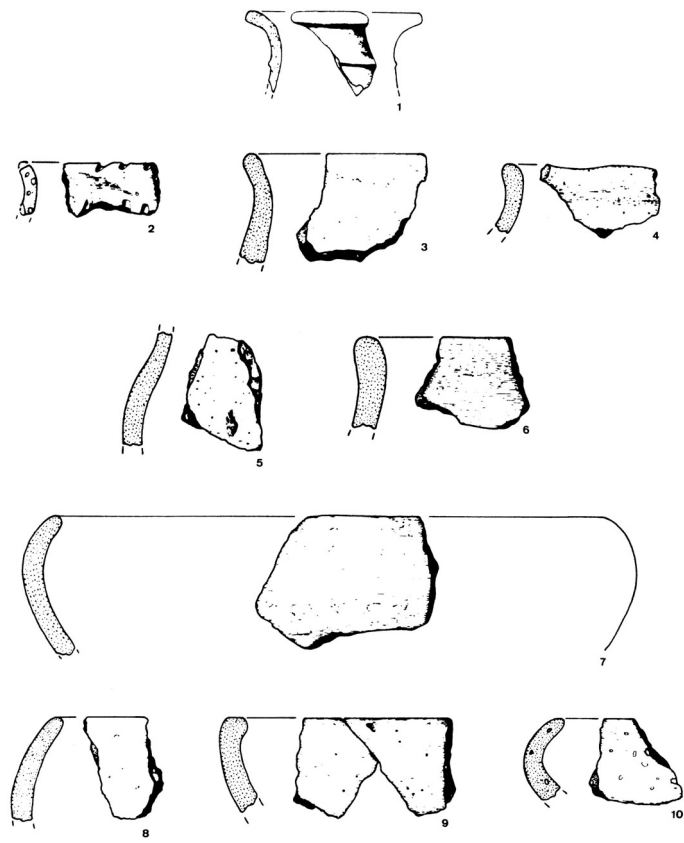

Abb. 177: Reutlingen, RT, Achalm, ‚Rappenplatz‘ (563c). 1-4. 5-9. 16.17.22 Bronze; 18 Eisen; 10-13.15 Glas; 14 Bernstein; 19 Eberzahn; 20.21 Knochen; 23 Kalkstein. 1.2.19.21.22 M. 1:1; sonst M. 1:2.

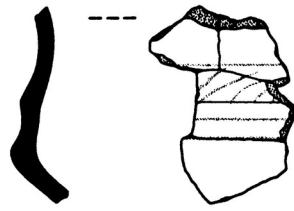

Abb. 178: St. Johann-Würtingen, RT, ‚Stettenrain‘ (567). etwa M. 1:2.

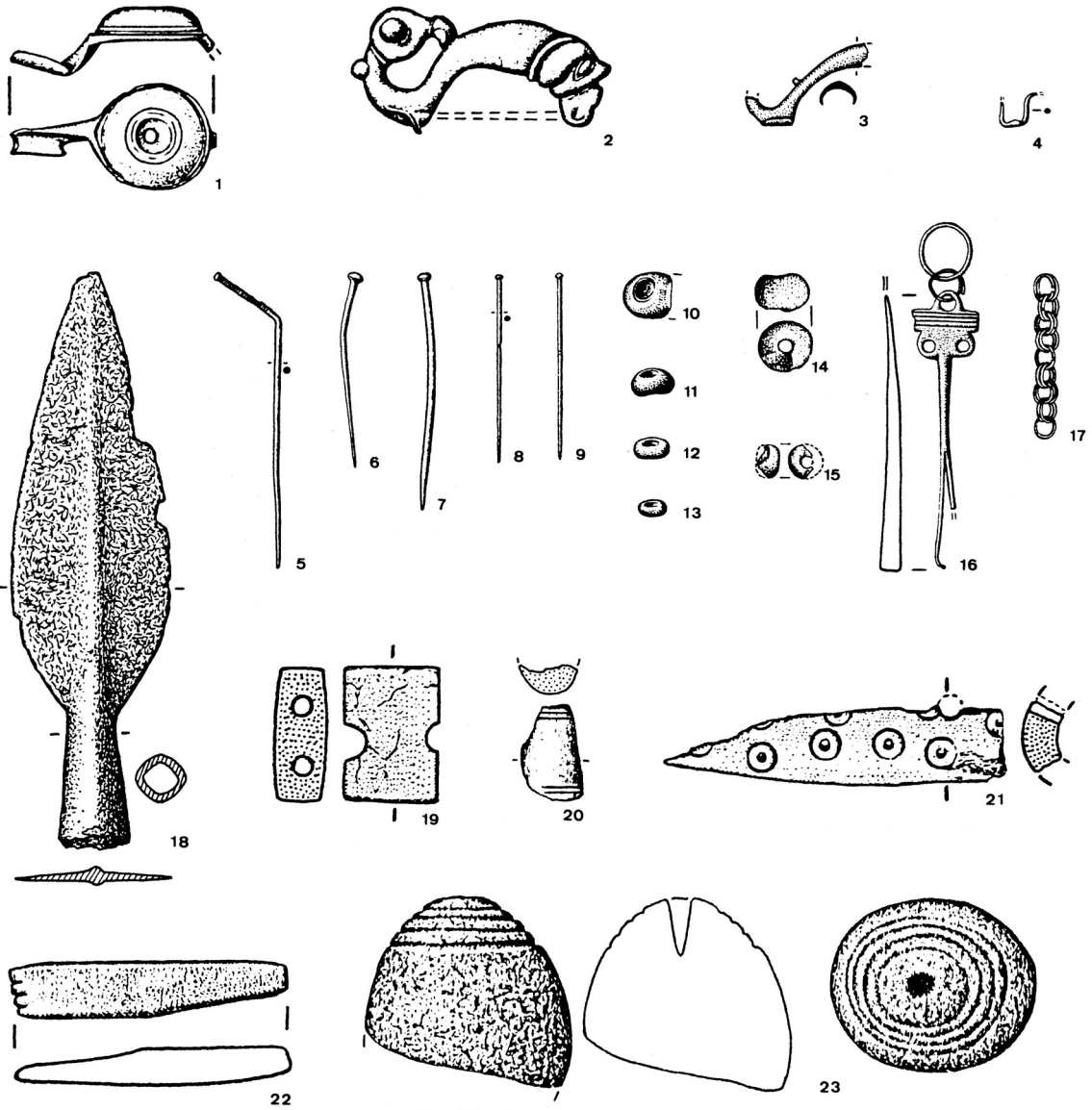

Abb. 179: Bad Urach, ‚Burren‘ (573b). M. 1:2.



Abb. 180: Albstadt-Ebingen, BL, ‚Kienten‘ (591). M. 1:2.

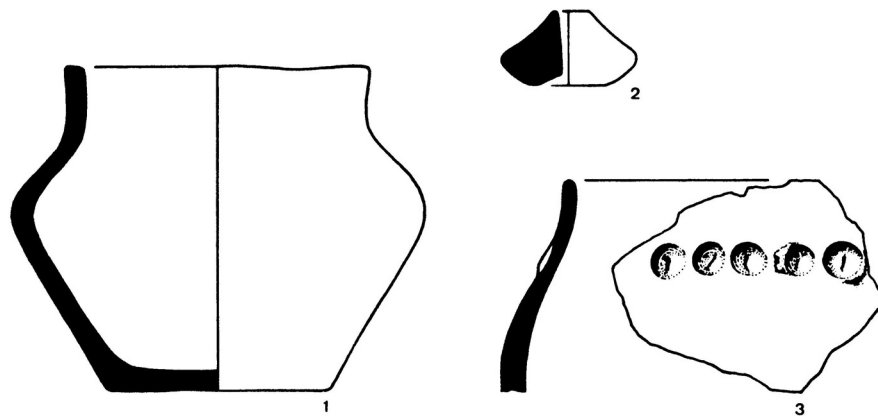

Abb. 181: Hausen am Tann, BL, ‚Lochenstein‘ (600). 1.8.24 Eisen; 12.13 Lignit; 14-21 Glas; 22 Ton; 23 Knochen.
24 M. 1:2; sonst M. 2:3.

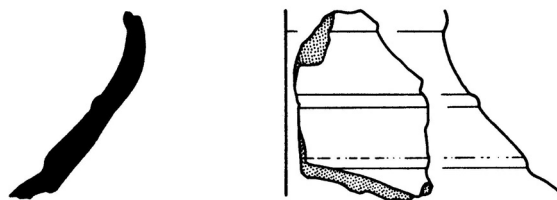

Abb. 182: Lauterach, UL, 'Bärenhöhle' (615) M. 1:2.

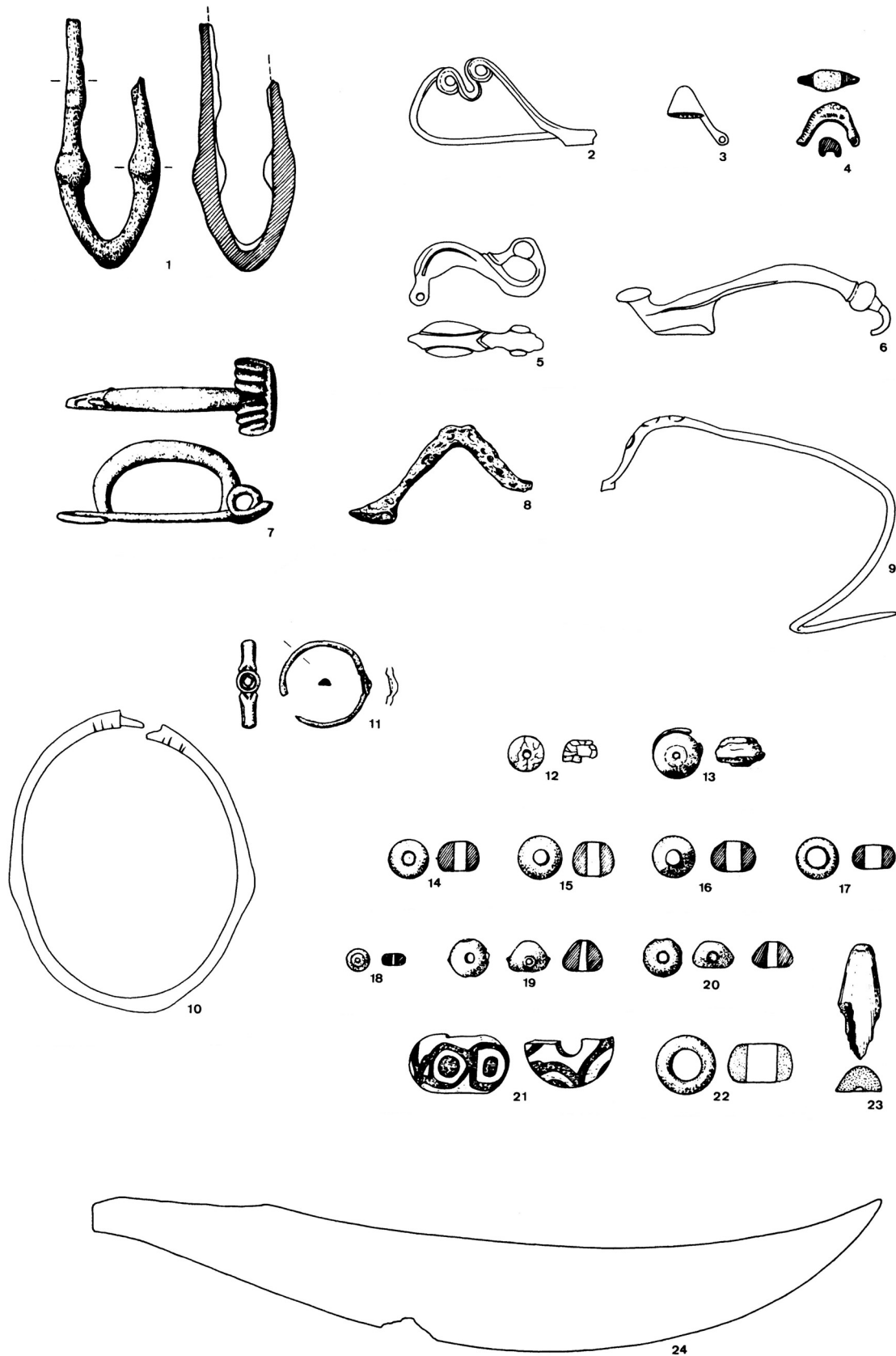

Abb. 183: Uttenweiler-Offingen, BC, 'Bussen' (622). 1 Bronze. 1 M. 2:3; sonst M. 1:2.

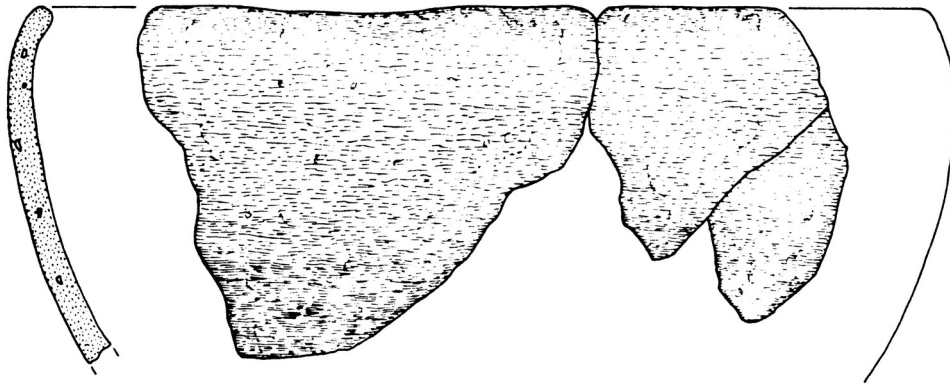
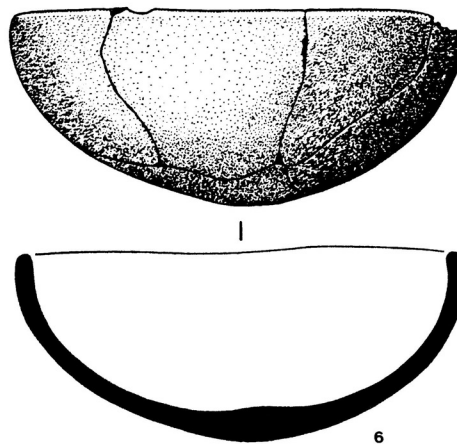
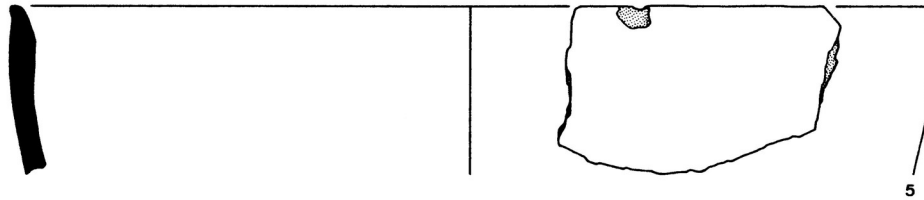
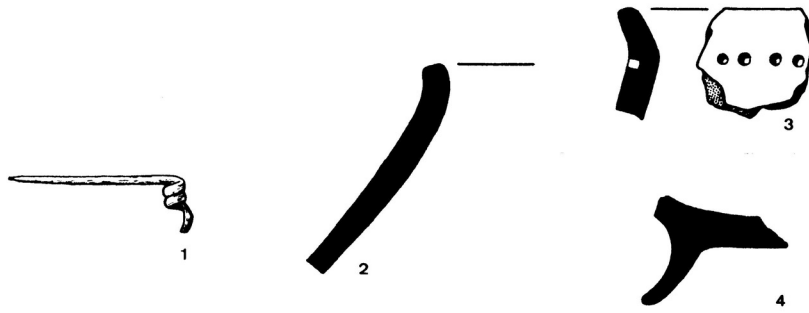
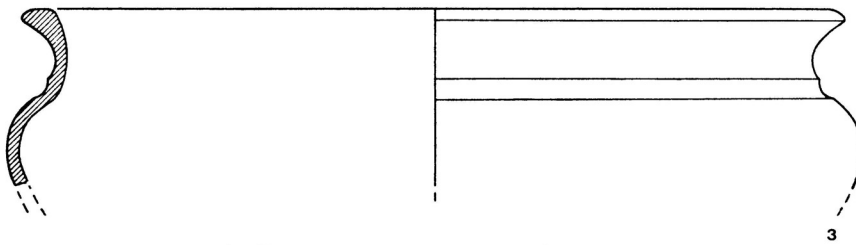
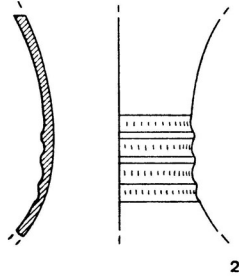
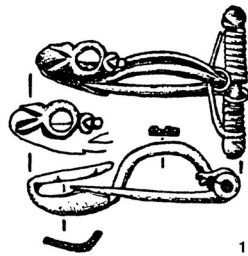

Abb. 184: Herberlingen-Hundersingen, SIG, „Heuneburg“ (628). 1 Bronze. 1 M. 1:1; 2.3 M. 1:2.